



ConnectPort[®] X3 Family

Getting Started Guide

Table of Contents

1	Introduction	3
1.1	ConnectPort X3 Product Features	4
1.2	ConnectPort X3 H Product Features	5
1.3	ConnectPort X3 and ConnectPort X3 H LEDs.....	6
1.4	ConnectPort X3 R Product Features	8
2	iDigi®	10
2.1	What is iDigi®?	10
2.2	What is Cloud Computing?	10
2.3	What is a Device Network?.....	10
2.4	What is the iDigi® Developer Cloud™?.....	10
2.5	What is iDigi Manager Pro™?	10
2.6	Create an iDigi® Developer Account	11
2.7	iDigi Manager Pro™	13
3	Digi ESP™ for Python.....	15
3.1	Digi ESP™ for Python Overview	15
3.2	Download and Install Digi ESP™ for Python.....	15
4	Configuring the Initial ConnectPort X3 Gateway Settings	17
5	Using Digi ESP™ for Python.....	22
6	Viewing Uploaded Data on iDigi®	34

1 Introduction

Please note that this guide is applicable to the entire ConnectPort X3 family of gateways. Certain steps or screenshots may reference a specific gateway for instructional purposes (generally the ConnectPort X3 R), but the information is valid for each of the three ConnectPort X3 gateways.

Throughout this guide you will:

1. Create an iDigi developer account and add your ConnectPort X3 gateway to your iDigi device inventory.
2. Download and install the Digi ESP for Python Integrated Development Environment (IDE), which will allow you to run your first Python sample program. This sample program will be used to upload the ConnectPort X3 gateway's GPS data to iDigi.
3. Run the Digi X3 Dashboard program (provided as part of the Digi ESP for Python installation process) in order to perform some initial configuration of the ConnectPort X3 gateway via the USB port.
4. Verify the connection between your ConnectPort X3 gateway and iDigi via the device's cellular interface.
5. Use the Digi ESP for Python IDE to build, download, and run your first Python sample project on your ConnectPort X3 gateway.
6. View the uploaded GPS data from the ConnectPort X3 gateway using iDigi Manager Pro.

1.1 ConnectPort X3 Product Features

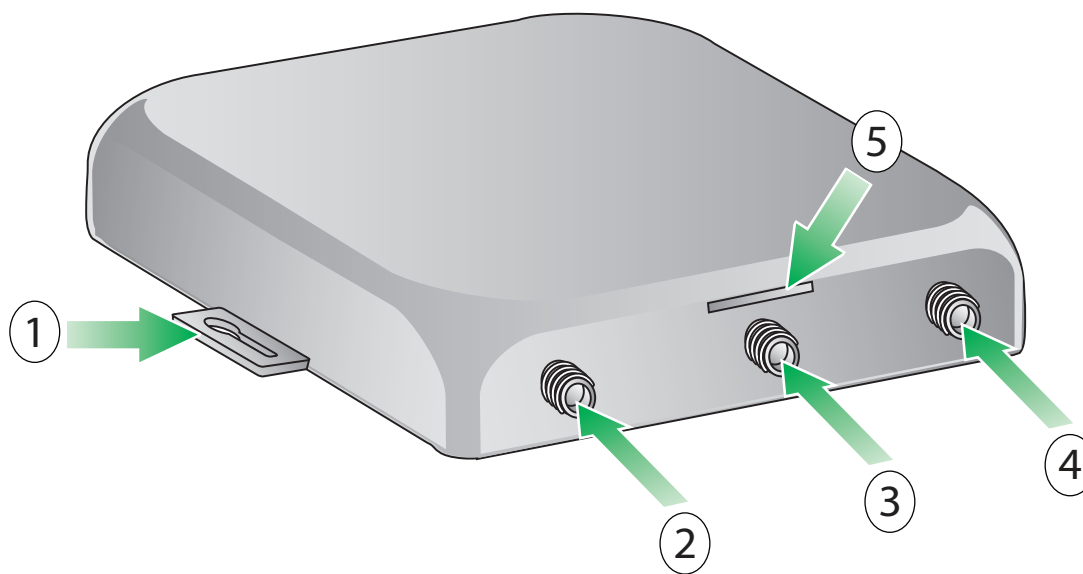

1. Mounting feet
2. Cellular antenna connector
3. XBee antenna connector
4. GPS antenna connector
5. SIM slot

1.2 ConnectPort X3 H Product Features

Note: The ConnectPort X3 H module is housed within a NEMA enclosure. The image shown below identifies the NEMA-enclosure hardware features for the product only. Please refer to the ConnectPort X3 Product Features section on page 4 for the ConnectPort X3 hardware within the NEMA enclosure. Product appearance may vary slightly based on configuration.

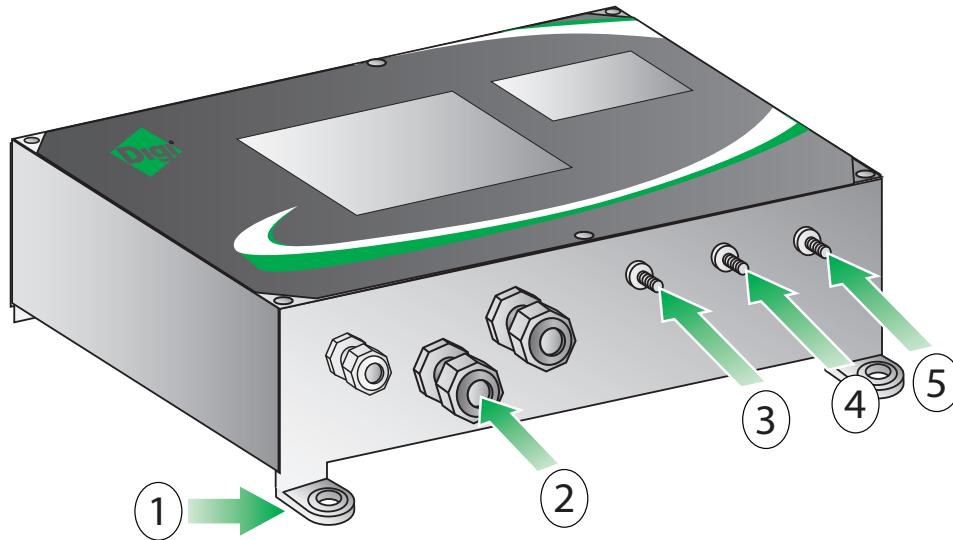

1. Mounting feet
2. Cable fittings
3. Cellular antenna connector
4. XBee antenna connector
5. GPS antenna connector

1.3 ConnectPort X3 and ConnectPort X3 H LEDs

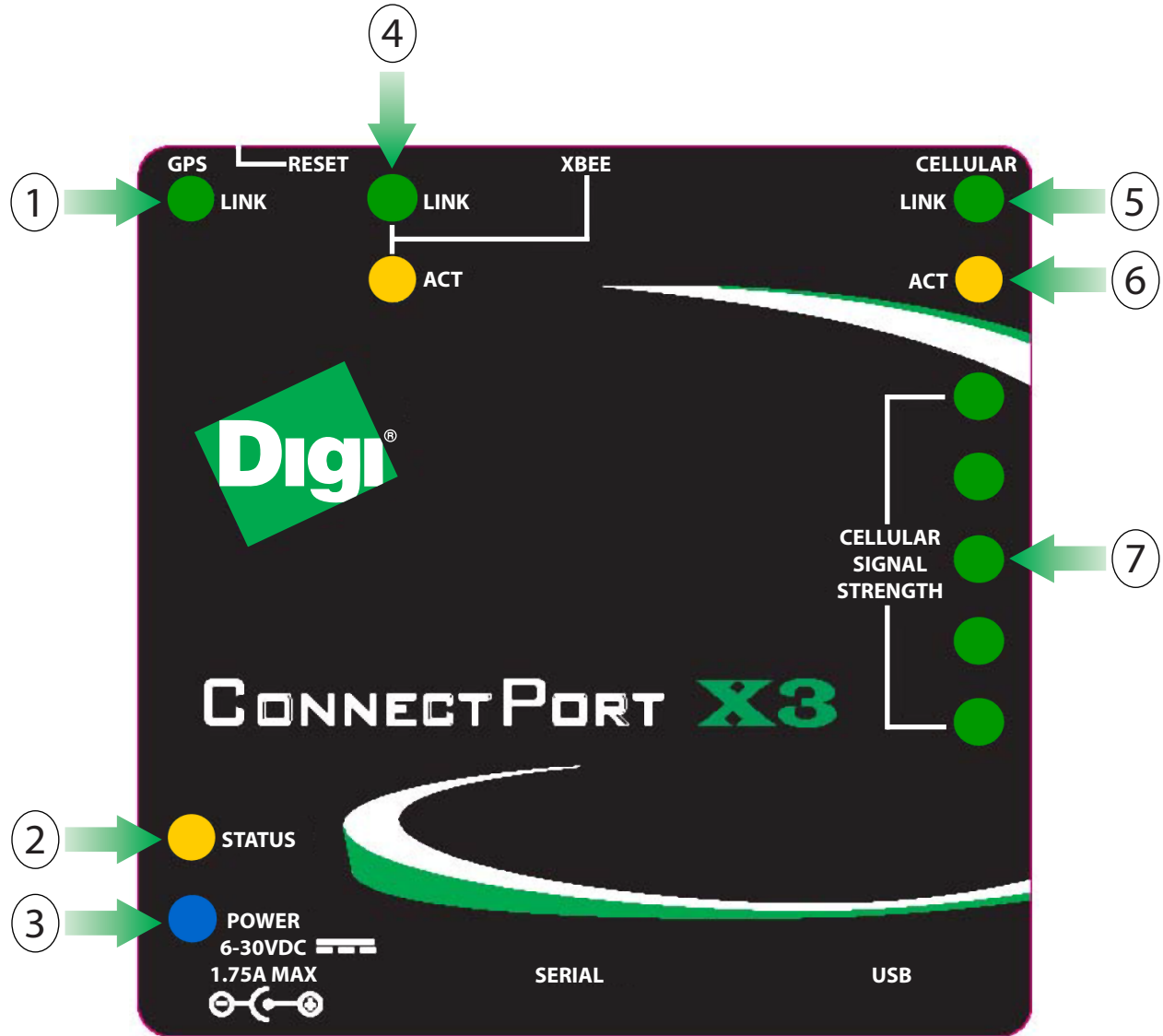

1. GPS Lock LED
2. Status LED
3. Power LED
4. XBee Link and Activity LEDs
5. Cellular Link LED
6. Cellular Activity LED
7. Cellular Signal Strength LEDs

The following table displays LED functionality for the ConnectPort X3 and ConnectPort X3 H.

LED	Color and Light Pattern	Description
Power	Off	Device is off
	Solid blue	Device is on
Status	Blinking amber	Normal operation
	Solid amber	Device is initializing
Cellular Link	Solid green	Connected to the cellular network
Cellular Activity	Blinking amber	Cellular traffic/activity
Cellular Signal Strength	Solid green	Relative signal strength indicator (RSSI), shown as a number of LEDs. <ul style="list-style-type: none"> - 0 LEDs: No signal - 1-2 LEDs: Weak cellular signal - 3-5 LEDs: Good cellular signal
GPS	Off	No GPS satellites in range
	Blinking green	GPS satellites detected, acquiring lock. Note: <i>If the antenna is not connected to the ConnectPort X3 device, the GPS device can indicate “phantom” satellites. This will cause the device to behave as if many satellites are visible to it, though it will never establish a satellite lock. This behavior is visible as continuous, fast blinking.</i>
	Solid green	GPS has a lock
Xbee Link	Solid green	XBee link is up
Xbee Activity	Blinking amber	XBee traffic/activity

1.4 ConnectPort X3 R Product Features

Side View

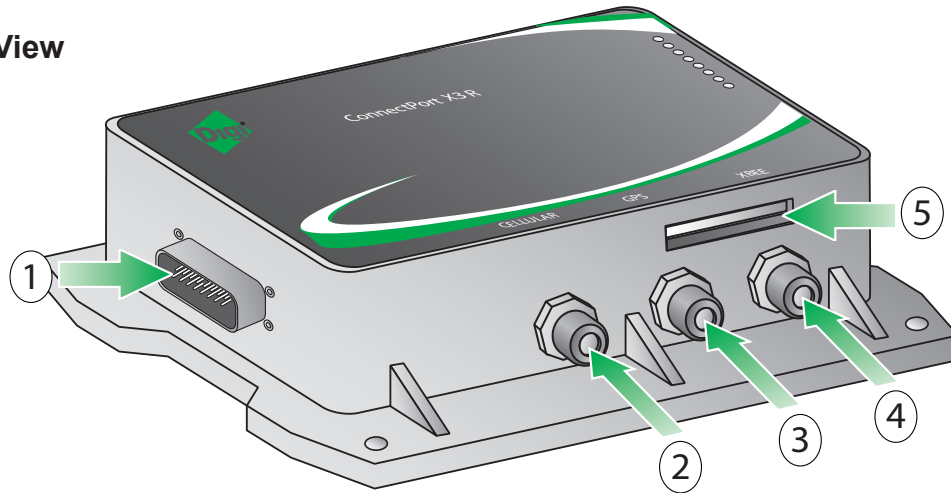

1. Wiring Harness connector
2. Cellular antenna connector
3. GPS antenna connector
4. XBee antenna connector
5. SIM slot

Top View

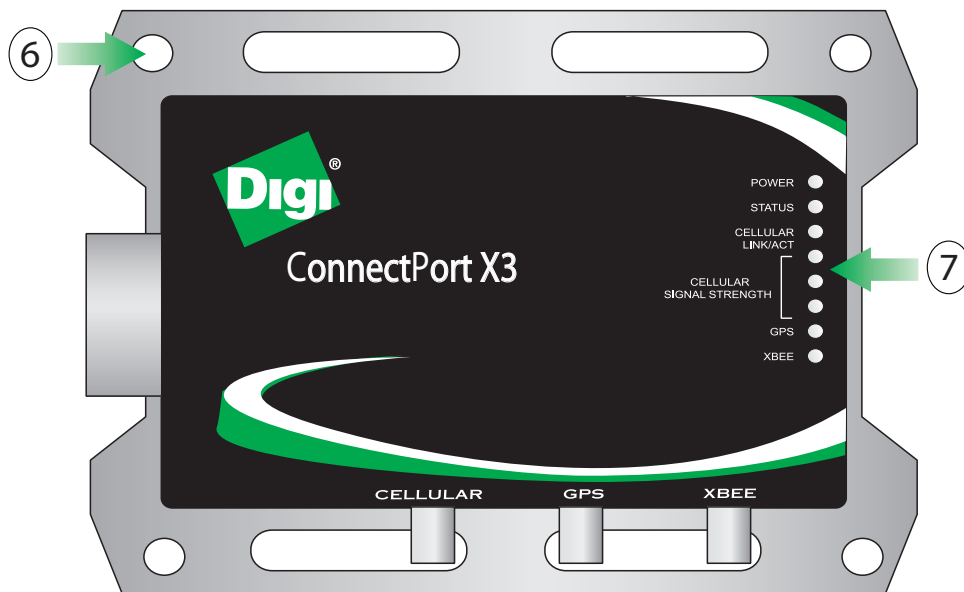

6. Mounting holes
7. LED status indicators

1.4.1 ConnectPort X3 R LEDs

The following table displays LED functionality for the ConnectPort X3 R.

LED	Color and Light Pattern	Description
POWER	Off	Device is off
	Solid blue	Device is on
STATUS	Blinking amber	Normal operation
	Solid amber	Device is initializing
CELLULAR LINK/ACT	Solid green	Connected to the cellular network
CELLULAR ACTIVITY	Blinking amber	Cellular traffic/activity
CELLULAR SIGNAL STRENGTH	Solid green	Relative signal strength indicator (RSSI), shown as a number of LEDs. <ul style="list-style-type: none"> - 0 LEDs: No signal - 1-2 LEDs: Weak cellular signal - 3-5 LEDs: Good cellular signal
GPS	Off	No GPS satellites in range
	Blinking green	GPS satellites detected, acquiring lock. Note: <i>If the antenna is not connected to the ConnectPort X3 device, the GPS device can indicate “phantom” satellites. This will cause the device to behave as if many satellites are visible to it, though it will never establish a satellite lock. This behavior is visible as continuous, fast blinking.</i>
	Solid green	GPS has a lock
XBEE	Solid green	XBee link is up
	Blinking amber	XBee traffic/activity

2 iDigi®

2.1 What is iDigi®?

The iDigi® Device Cloud™ is the embedded industry's first ready-to-use cloud computing platform for device networking and management. It provides secure application messaging, data storage and device management for networks comprised of wired, cellular and satellite-connected devices.

2.2 What is Cloud Computing?

Cloud computing offers a flexible new approach to delivering IT services. In the most basic sense, “The Cloud” is resources (hardware, software, infrastructure and device networks) that can be accessed through the internet. The benefits of cloud computing are similar to a public utility model: only buy what you need, when you need it, with the ability to quickly scale resources on-demand as resource utilization grows.

2.3 What is a Device Network?

Sometimes referred to as Machine-to-Machine (M2M), device networks enable both wired and wireless systems to communicate with other devices and applications. A device (such as a sensor or meter) captures an event (such as temperature, tank level, etc) which is relayed through a network aggregation layer (wired, wireless or both) and infrastructure to an application (software program) that translates the captured event into meaningful information (for example, tanks need to be emptied or refilled).

2.4 What is the iDigi® Developer Cloud™?

The iDigi Developer Cloud is iDigi's development environment for testing and prototyping device and application integration. It is very similar to the iDigi Device Cloud (with a limit of 5 devices).

2.5 What is iDigi Manager Pro™?

iDigi Manager Pro is the Software as a Service (SaaS) component of the iDigi Device Cloud. It is a web-based graphical user-interface for management and control of remote devices. iDigi Manager Pro will be discussed in more detail in section 2.7 iDigi Manager Pro™ on page 13.

For more information about iDigi visit the iDigi web site at www.idigi.com, or see the **iDigi User's Guide** available at <http://www.digi.com/connectportx3>.

2.6 Create an iDigi® Developer Account

An iDigi developer account is a full service iDigi user account providing access to a limited number of iDigi devices. It allows iDigi developers to set up a maximum of five iDigi devices in order to develop Python programs and iDigi client applications that will leverage the functionality provided by both iDigi and the iDigi devices.

Before you can connect your ConnectPort X3 gateway to iDigi, you must create an iDigi developer account.

1. Navigate to www.idigi.com.
2. Click the  **iDigi Login** button in the upper right corner of the page.
3. Click the **iDigi Developer Cloud** login button.

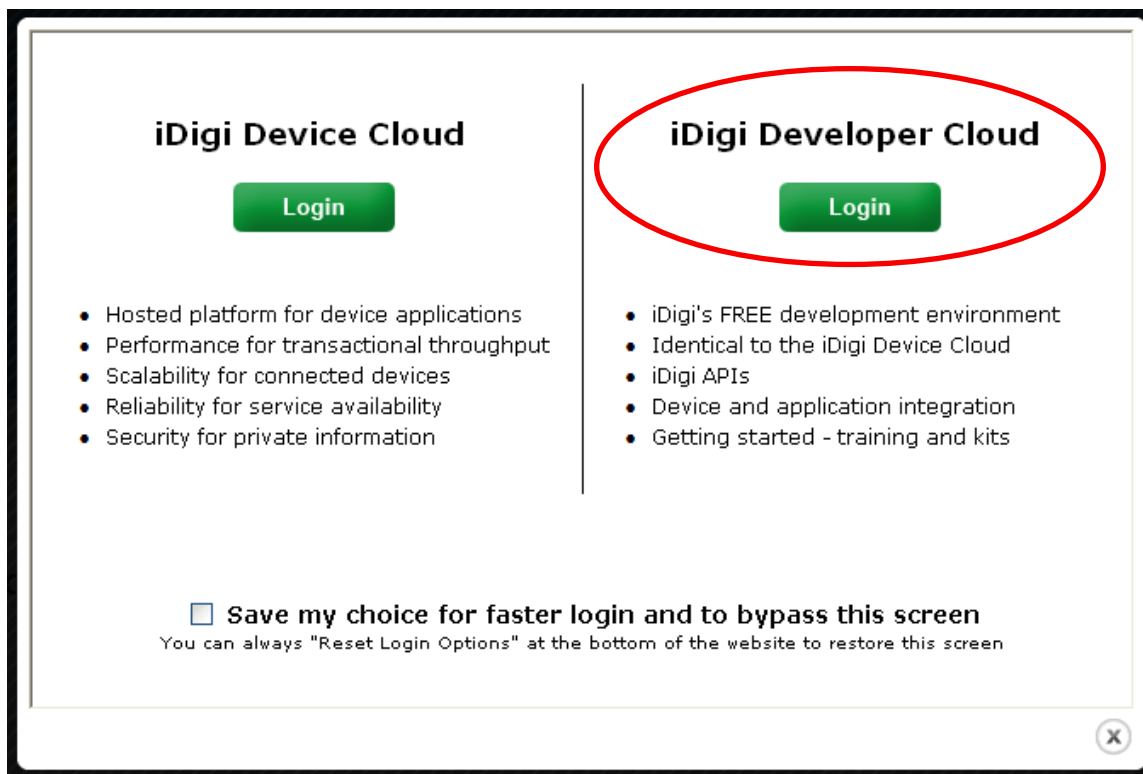

You will be redirected to the iDigi Developer Cloud login page.

4. If you are a current iDigi developer account user, login with your existing user name and password. If you are a new user, click on the “Are you a new user” link and follow the on-screen instructions to create an account.

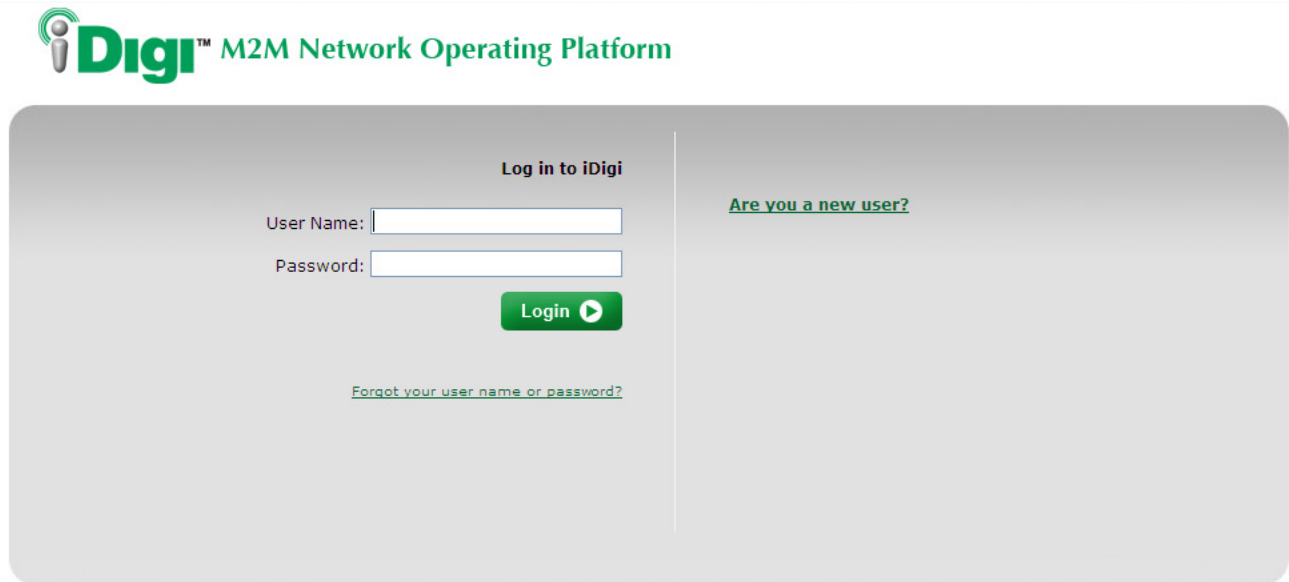

iDigi™ M2M Network Operating Platform

Log in to iDigi

User Name:

Password:

Login 

[Forgot your user name or password?](#)

[Are you a new user?](#)

Once you are logged in to the iDigi Developer Cloud via your developer account, the iDigi Manager Pro home page will be displayed (as shown below).

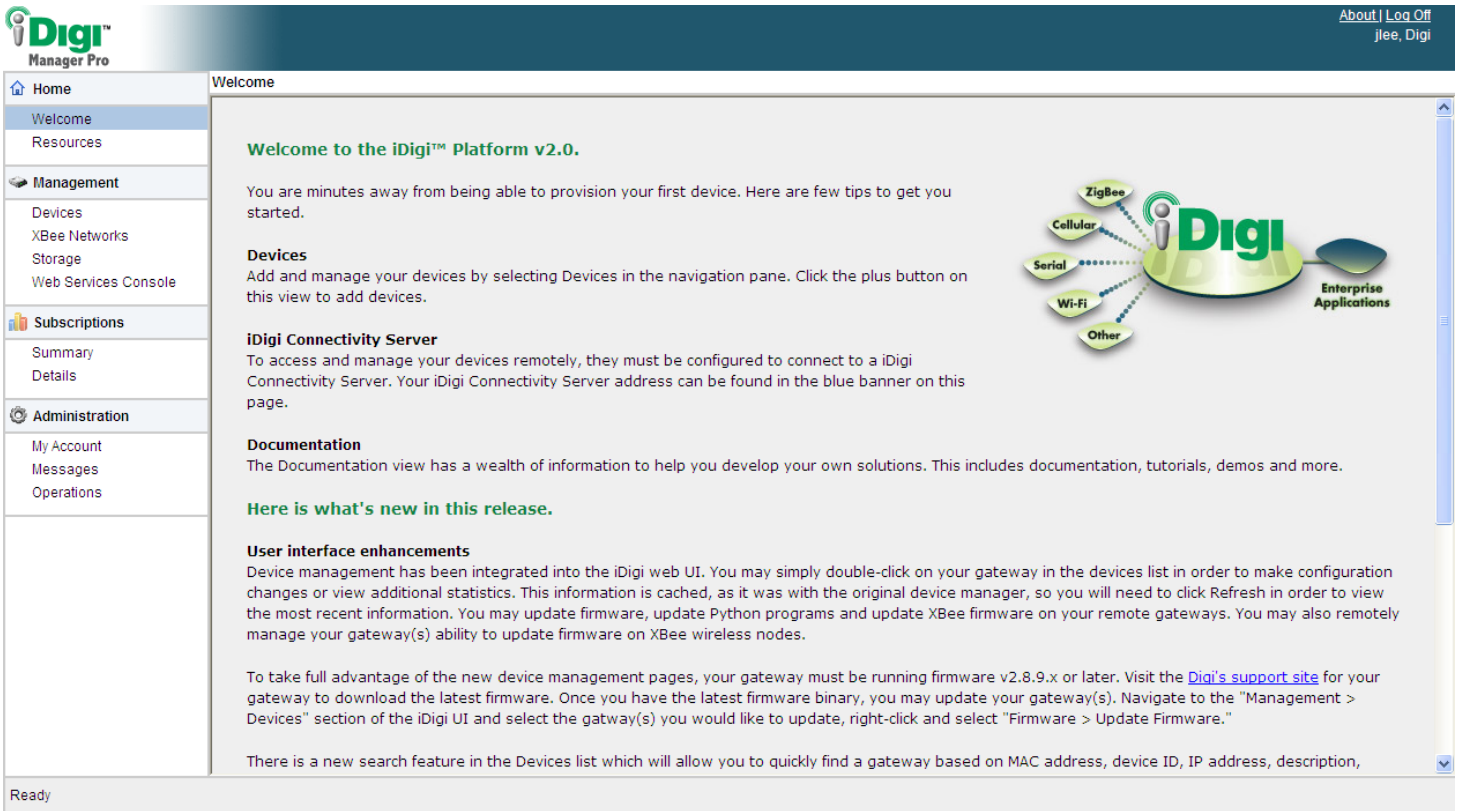

iDigi™ Manager Pro [About](#) | [Log Off](#)
Jee, Digi

Home | Welcome | Resources

Management

- Devices
- XBee Networks
- Storage
- Web Services Console

Subscriptions

- Summary
- Details

Administration

- My Account
- Messages
- Operations

Welcome

Welcome to the iDigi™ Platform v2.0.

You are minutes away from being able to provision your first device. Here are few tips to get you started.

Devices
Add and manage your devices by selecting Devices in the navigation pane. Click the plus button on this view to add devices.

iDigi Connectivity Server
To access and manage your devices remotely, they must be configured to connect to a iDigi Connectivity Server. Your iDigi Connectivity Server address can be found in the blue banner on this page.

Documentation
The Documentation view has a wealth of information to help you develop your own solutions. This includes documentation, tutorials, demos and more.

Here is what's new in this release.

User interface enhancements
Device management has been integrated into the iDigi web UI. You may simply double-click on your gateway in the devices list in order to make configuration changes or view additional statistics. This information is cached, as it was with the original device manager, so you will need to click Refresh in order to view the most recent information. You may update firmware, update Python programs and update XBee firmware on your remote gateways. You may also remotely manage your gateway(s) ability to update firmware on XBee wireless nodes.

To take full advantage of the new device management pages, your gateway must be running firmware v2.8.9.x or later. Visit the [Digi's support site](#) for your gateway to download the latest firmware. Once you have the latest firmware binary, you may update your gateway(s). Navigate to the "Management > Devices" section of the iDigi UI and select the gateway(s) you would like to update, right-click and select "Firmware > Update Firmware."

There is a new search feature in the Devices list which will allow you to quickly find a gateway based on MAC address, device ID, IP address, description,

Ready

2.7 iDigi Manager Pro™

iDigi Manager Pro is a web based device management application that allows a user to manage their inventory of iDigi devices. iDigi Manager Pro delivers capabilities that empower IT, network operations and customer support organizations to conquer the challenges of managing the vast array of equipment in their device networks, including:

- Centralized access and control of network equipment
- Security
- Provisioning of new equipment
- Decommissioning of equipment
- Adding functionality to the network

To add your ConnectPort X3 gateway to your iDigi inventory, perform the following steps:

1. Click on **Devices** from within the left navigation panel.
2. Click the  **Add Devices** button to bring up the Add Devices dialog.
3. The Add Devices applet will automatically discover iDigi devices connected to the PC's Ethernet network, but since the ConnectPort X3 gateway is connected via a USB cable, it needs to be manually added to your iDigi device inventory. Click the **Add Manually** button and enter the Modem Serial Number (IMEI or MEID) of the device (which can be found on the side label of the device).

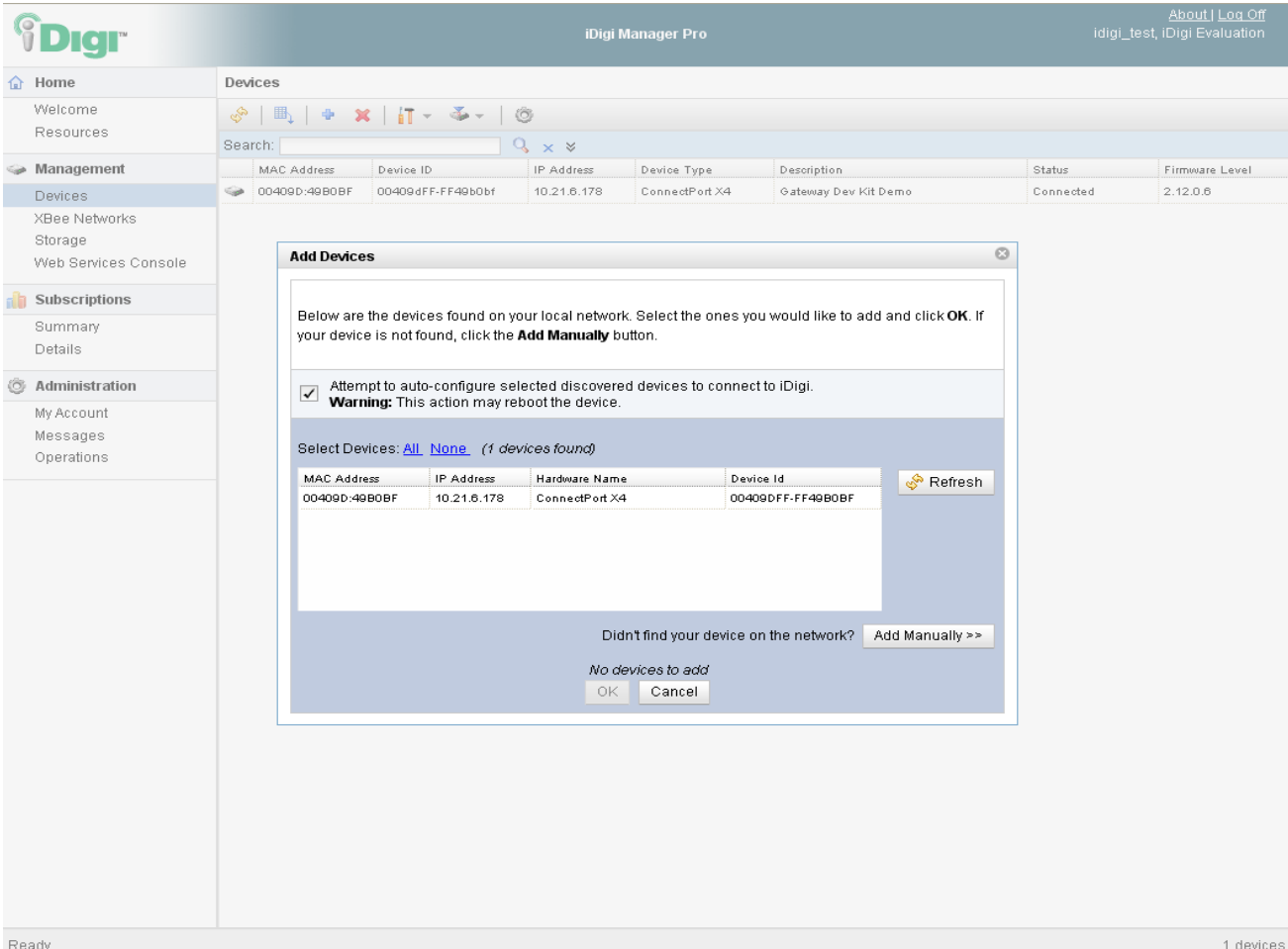

The screenshot shows the iDigi Manager Pro web interface. The main content area displays a table of devices. An 'Add Devices' dialog box is open, showing a table of discovered devices and an 'Add Manually' button.

Devices Table:

MAC Address	Device ID	IP Address	Device Type	Description	Status	Firmware Level
00409D:49B0BF	00409dFF-FF49b0bf	10.21.6.178	ConnectPort X4	Gateway Dev Kit Demo	Connected	2.12.0.6

Add Devices Dialog:

Below are the devices found on your local network. Select the ones you would like to add and click **OK**. If your device is not found, click the **Add Manually** button.

Attempt to auto-configure selected discovered devices to connect to iDigi.
Warning: This action may reboot the device.

Select Devices: [All](#) [None](#) (1 devices found)

MAC Address	IP Address	Hardware Name	Device Id
00409D:49B0BF	10.21.6.178	ConnectPort X4	00409DFF-FF49B0BF

Buttons: Refresh, Add Manually >>, OK, Cancel

Footer: Ready | 1 devices

4. Ensure the device is displayed in the devices list on the Devices Page. Notice that the status column indicates **Disconnected**. Later in this guide you will configure the ConnectPort X3 gateway to properly establish both a cellular and iDigi connection which will change this state to “Connected”.

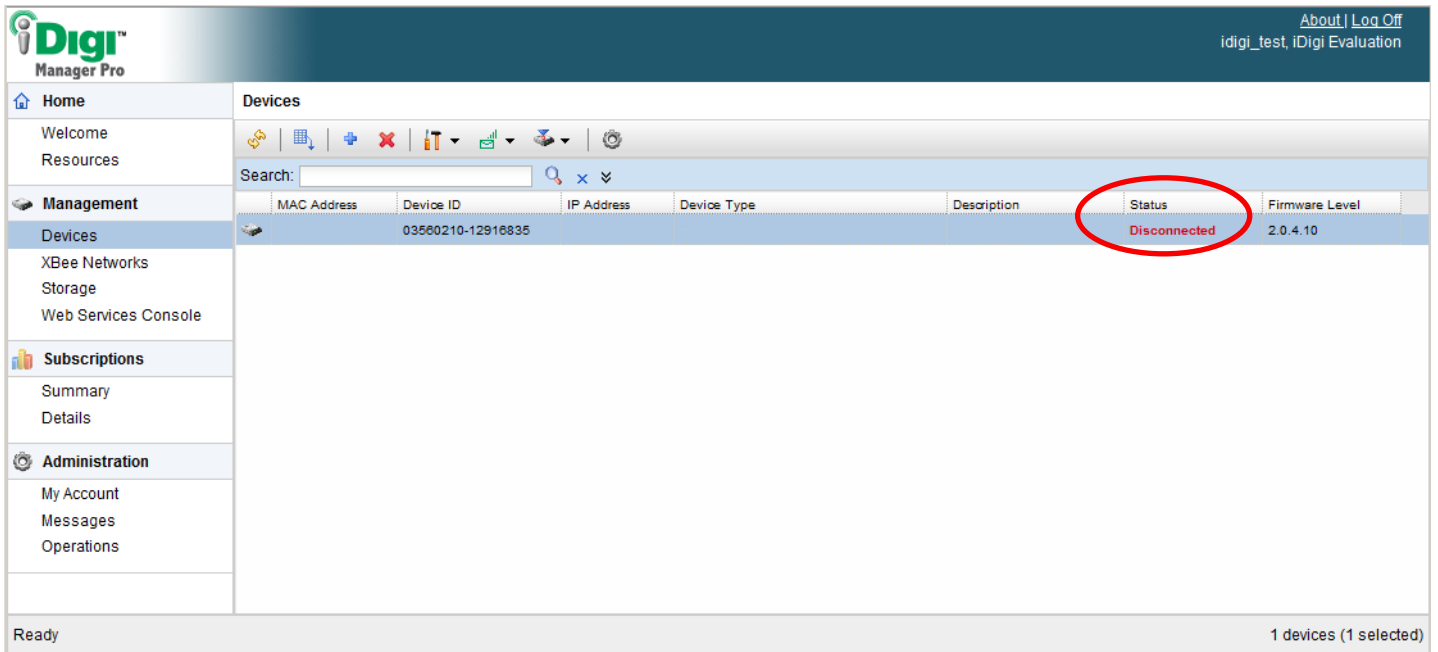

The screenshot displays the iDigi Manager Pro web interface. The top navigation bar includes the iDigi logo and links for 'About', 'Log Off', and 'idigi_test, iDigi Evaluation'. The main content area is titled 'Devices' and features a search bar and a table of device information. The table has columns for MAC Address, Device ID, IP Address, Device Type, Description, Status, and Firmware Level. A single device is listed with a status of 'Disconnected', which is highlighted with a red circle. The bottom status bar shows 'Ready' and '1 devices (1 selected)'.

MAC Address	Device ID	IP Address	Device Type	Description	Status	Firmware Level
	03560210-12916835				Disconnected	2.0.4.10

3 Digi ESP™ for Python

3.1 Digi ESP™ for Python Overview

Built on the open Eclipse framework, Digi ESP for Python provides an easy-to-use and professional Python development environment with graphical user interface.

Digi ESP for Python offers a wide variety of state-of-the-art development tool features that make embedded development easier and faster than ever before. These include intelligent editor coding aids (syntax highlighting, auto-indent/bracket-matching, code completion assistance), on-the-fly template insertion, and simple single-click initiation of project build processes and debug sessions. This development environment also includes extensive documentation, tutorials, and code samples to help you get started developing custom applications for your product.

For example, applications can be created to:

- Aggregate data on the ConnectPort X3 gateway throughout the day, then upload to iDigi once a day.
- Develop a driver for a custom protocol to talk to a device connected to the ConnectPort X3 gateway.
- Translate data, for example, from raw serial into an XML format that can be consumed by other systems, such as iDigi.

3.2 Download and Install Digi ESP™ for Python

1. Navigate to <http://www.digi.com/connectportx3> and click on the **Download Digi ESP for Python** link.
2. The various download options for the Digi ESP for Python framework will be displayed on this page. Based on your operating system, click the link to download Digi ESP for Python.

The screenshot shows the Digi website's 'Product: Python' page. The page header includes the Digi logo and the tagline 'Making Wireless M2M Easy'. The navigation menu includes Solutions, iDigi, Services, Products, Learning Center, Support, About us, and How to buy. The main content area displays the product name 'Product: Python' with a status of 'Active' and support status 'Web, Email, Phone'. It provides contact information: 877-912-3444 (U.S. & Canada) and +1 952-912-3456 (Worldwide). A 'Submit a support ticket' button is also visible. The 'Related Links' section includes links for 'Login to Digi Support', 'Support forum', 'FTP Site', 'Submit feedback on our support site', and 'RoHS compliance'. The 'Knowledge Base' section offers a search for solutions, technical articles, and FAQs. The 'Drivers' section lists various resources: Drivers, Firmware Updates, Documentation, Diagnostics, Utilities and MIBs, Cabling, Knowledge base, Warranty registration, Support forum, Service agreements, Return merchandise, Online support request, and Manage Subscriptions. The 'General Drivers' section includes a link to 'How to install Digi ESP for Python' and a 'Subscribe' button. Below this, there are three download links: 'Digi ESP for Python - Mac OS X (10.6) installer ver. 1.3.0', 'Digi ESP for Python - Windows XP/Vista/Windows 7 installer ver. 1.3.0', and 'Digi ESP for Python ver. 1.3.0 release notes', each with a 'Subscribe' button. A red arrow points to the first two download links.

- Once the Digi ESP for Python framework has been downloaded, run the Digi ESP for Python framework installation wizard. Follow the steps in the wizard until the **Choose Components** dialog is displayed.
- When the Choose Components dialog is displayed, select the installation specific to your ConnectPort X3 gateway. For the example used in this guide, the **ConnectPort X3 R Kit** installation is selected.

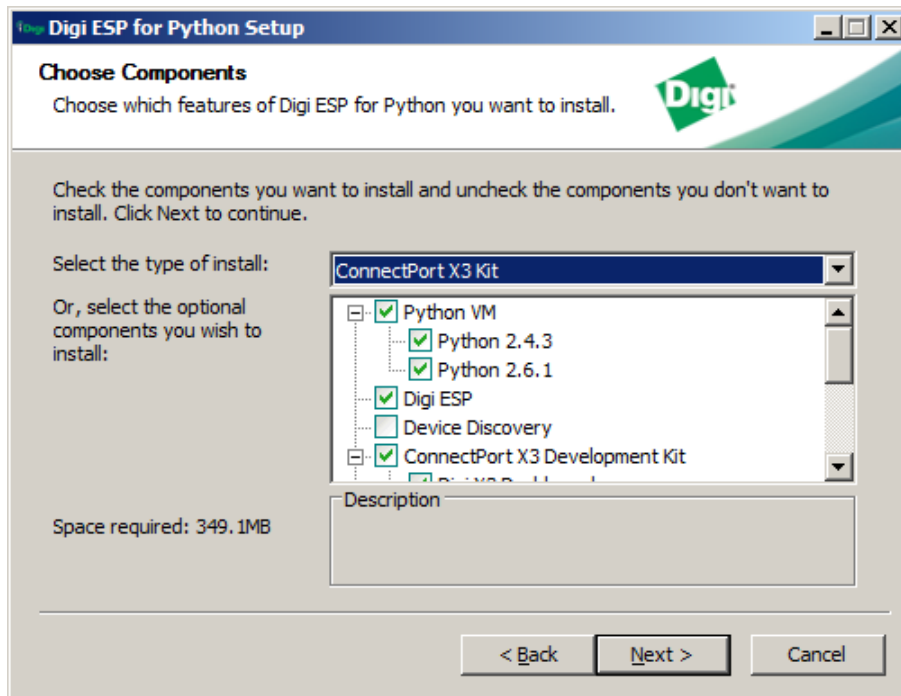

- Follow the installation until arriving at the **Completing the Digi ESP for Python Setup Wizard** dialog. Uncheck both options, then click **Finish**.



- Close the Digi ESP for Python program.

4 Configuring the Initial ConnectPort X3 Gateway Settings

The Digi X3 Dashboard is a simple Microsoft Windows application for configuring basic settings of the ConnectPort X3 gateway.

Note: The Digi X3 Dashboard program was included in the Digi ESP for Python download mentioned in the previous chapter.

To configure your unit:

1. Open the Digi X3 Dashboard. To do so, navigate to **Start > Digi > Digi X3 Dashboard > Digi X3 Dashboard**. Once the Digi X3 Dashboard opens the **Device Information** tab should be displayed as shown below.

Note: The Digi X3 Dashboard will not open unless the ConnectPort X3 gateway is connected to your PC via a USB port.

Note: The Digi X3 Dashboard **OK** button applies changes then exits the program; the **Apply** button applies changes without exiting. Use the apply button throughout this configuration process until all configuration settings have been applied, and you are instructed to exit the Digi X3 Dashboard program.

The screenshot shows the Digi X3 Dashboard application window with the following content:

- Device Information** (selected tab):
 - Device Status: Status is **Connected [COM14]**. A **Refresh** button is present.
 - Device Information:
 - Product: **ConnectPort X3R**
 - Firmware Version: **Version 2.0.4.10**
 - Mobile Information:
 - Serial Number (IMEI): **356021012916835**
 - Phone Number: **16128451724**
 - ICCID: **89014103212310584315**
 - IMSI: **310410231058431**
 - Modem Type: **WAVECOM WIRELESS CPU**
 - Modem Revision: **B7.42.0.201001280843.WMP100 21 31488 012810 08:43**
 - Mobile Connection:
 - Link:
 - Signal Strength:
 - Mobile IP Address: **0 . 0 . 0 . 0**
- Buttons: **OK**, **Cancel**, and **Apply**.

2. To configure your mobile settings click, on the **Mobile** tab. Enter your service plan/APN information into the **Service Plan/APN** field then click **Apply**.

Note: “i2gold” is for example purposes only. Enter your specific service plan/APN information in place of this text.

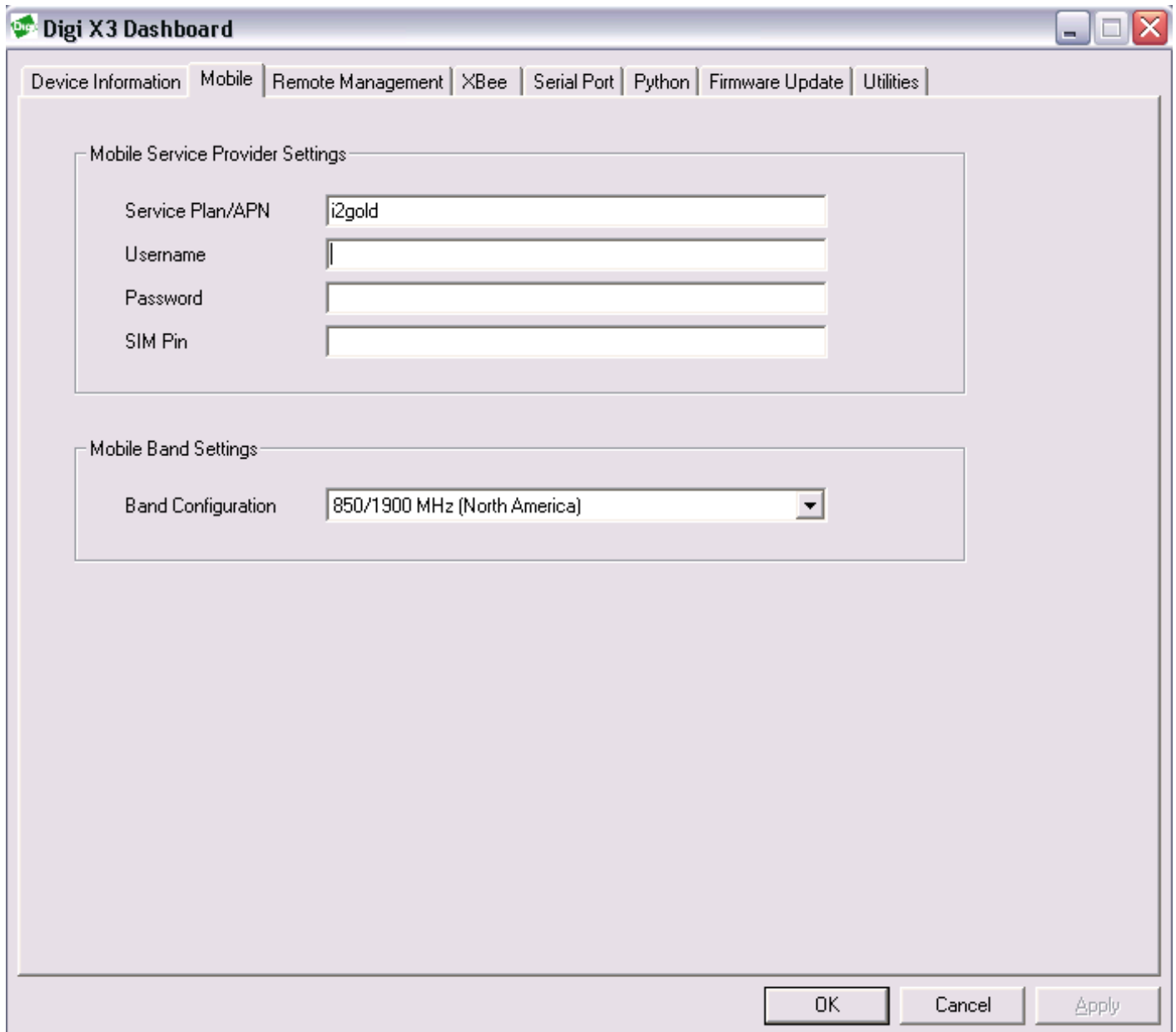

The screenshot shows the 'Digi X3 Dashboard' window with the 'Mobile' tab selected. The window contains two main sections: 'Mobile Service Provider Settings' and 'Mobile Band Settings'. The 'Mobile Service Provider Settings' section has four input fields: 'Service Plan/APN' (containing 'i2gold'), 'Username', 'Password', and 'SIM Pin'. The 'Mobile Band Settings' section has a dropdown menu for 'Band Configuration' (set to '850/1900 MHz (North America)'). At the bottom right, there are three buttons: 'OK', 'Cancel', and 'Apply'.

Section	Field	Value
Mobile Service Provider Settings	Service Plan/APN	i2gold
	Username	
	Password	
	SIM Pin	
Mobile Band Settings	Band Configuration	850/1900 MHz (North America)

- The Remote Management tab is used to provide the address of the iDigi Device Cloud which is “developer.idigi.com” in this case. Click on the **Remote Management** tab and configure your settings to match what is displayed in the image below, then click **Apply**.

The screenshot shows the 'Digi X3 Dashboard' window with the 'Remote Management' tab selected. The window title bar includes the Digi logo and the text 'Digi X3 Dashboard'. The tab bar at the top contains the following tabs: 'Device Information', 'Mobile', 'Remote Management', 'XBee', 'Serial Port', 'Python', 'Firmware Update', and 'Utilities'. The main content area is titled 'Device-initiated Management Connection' and contains the following settings:

- Enable Remote Management and Configuration using a device-initiated connection
- Server Address:
- Automatically reconnect to the server after being disconnected
- Reconnect after: hrs mins secs

At the bottom right of the window, there are three buttons: 'OK', 'Cancel', and 'Apply'.

- Go back to the **Device Information** tab. The **Mobile IP Address** field should display the IP address obtained on the cellular interface, and the **CELLULAR LINK/ACT** LED should have turned green to indicate that a cellular connection has been established.

Note: For ConnectPort X3 and ConnectPort X3 H users, verify that the **Cellular Link LED** turned green.

Note: If an IP address is not displayed and the LED is not green, click the **Refresh** button and wait a few seconds for the ConnectPort X3 gateway to refresh its configuration settings.

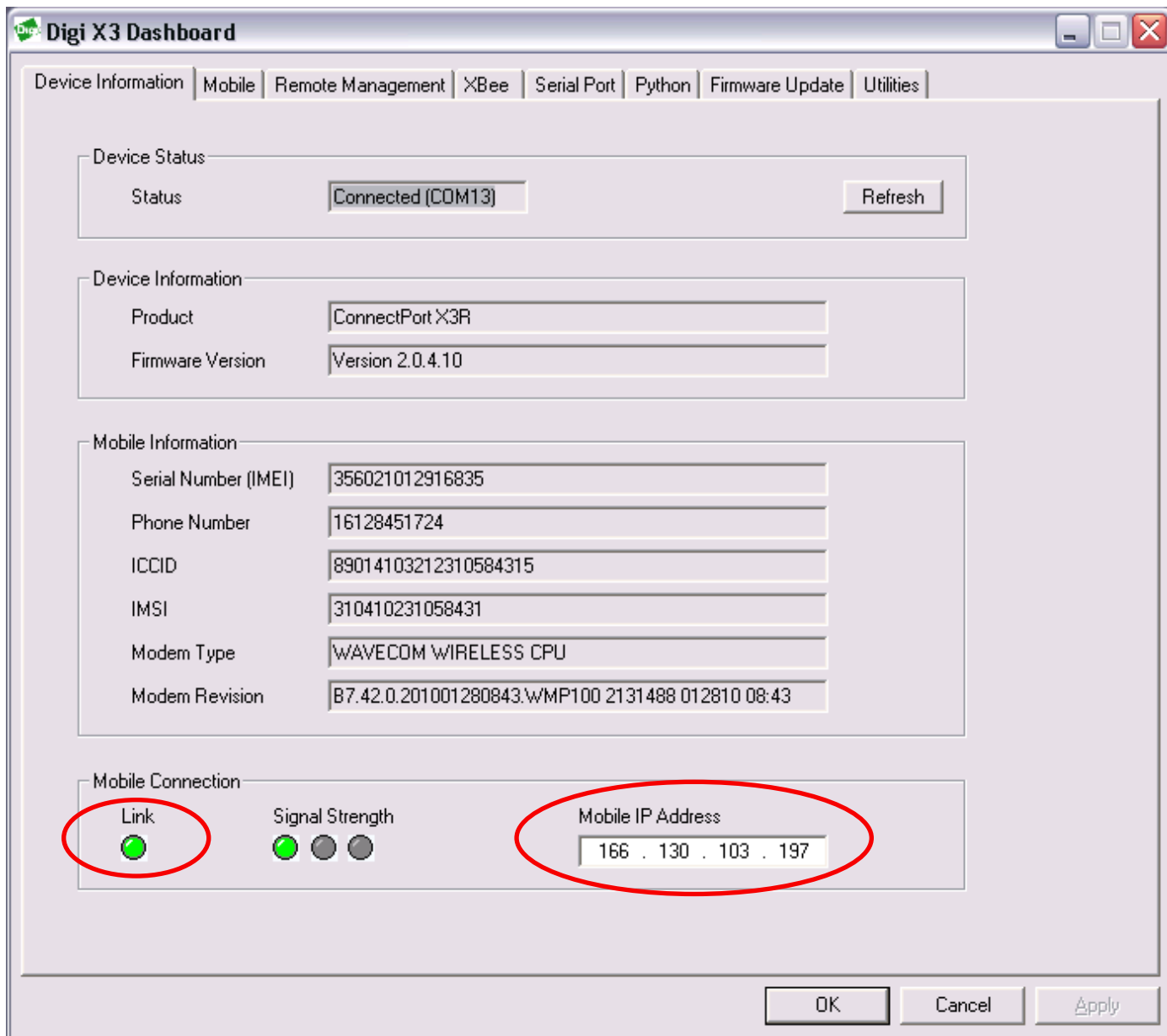

The screenshot shows the Digi X3 Dashboard interface. The 'Device Information' tab is selected. The 'Mobile Information' section displays various identifiers: Serial Number (IMEI) 356021012916835, Phone Number 16128451724, ICCID 89014103212310584315, IMSI 310410231058431, Modem Type WAVECOM WIRELESS CPU, and Modem Revision B7.42.0.201001280843.WMP100 2131488 012810 08:43. The 'Mobile Connection' section shows a green 'Link' LED and a 'Signal Strength' indicator with three green circles. The 'Mobile IP Address' field displays '166 . 130 . 103 . 197'. The 'Link' LED and the IP address field are circled in red. At the bottom, there are 'OK', 'Cancel', and 'Apply' buttons.

Section	Field	Value
Device Status	Status	Connected (COM13)
	Refresh	Refresh
Device Information	Product	ConnectPort X3R
	Firmware Version	Version 2.0.4.10
Mobile Information	Serial Number (IMEI)	356021012916835
	Phone Number	16128451724
	ICCID	89014103212310584315
	IMSI	310410231058431
	Modem Type	WAVECOM WIRELESS CPU
	Modem Revision	B7.42.0.201001280843.WMP100 2131488 012810 08:43
Mobile Connection	Link	Green LED
	Signal Strength	Three Green Circles
	Mobile IP Address	166 . 130 . 103 . 197

- Click **OK** to exit the Digi X3 Dashboard program.

Once the cellular connection has been established, and the iDigi configuration is in place, your ConnectPort X3 gateway is properly configured.

6. Verify the ConnectPort X3 gateway's connection to iDigi by opening the Device Page within iDigi Manager Pro, and ensuring that the status column shows **Connected** for the device's status.

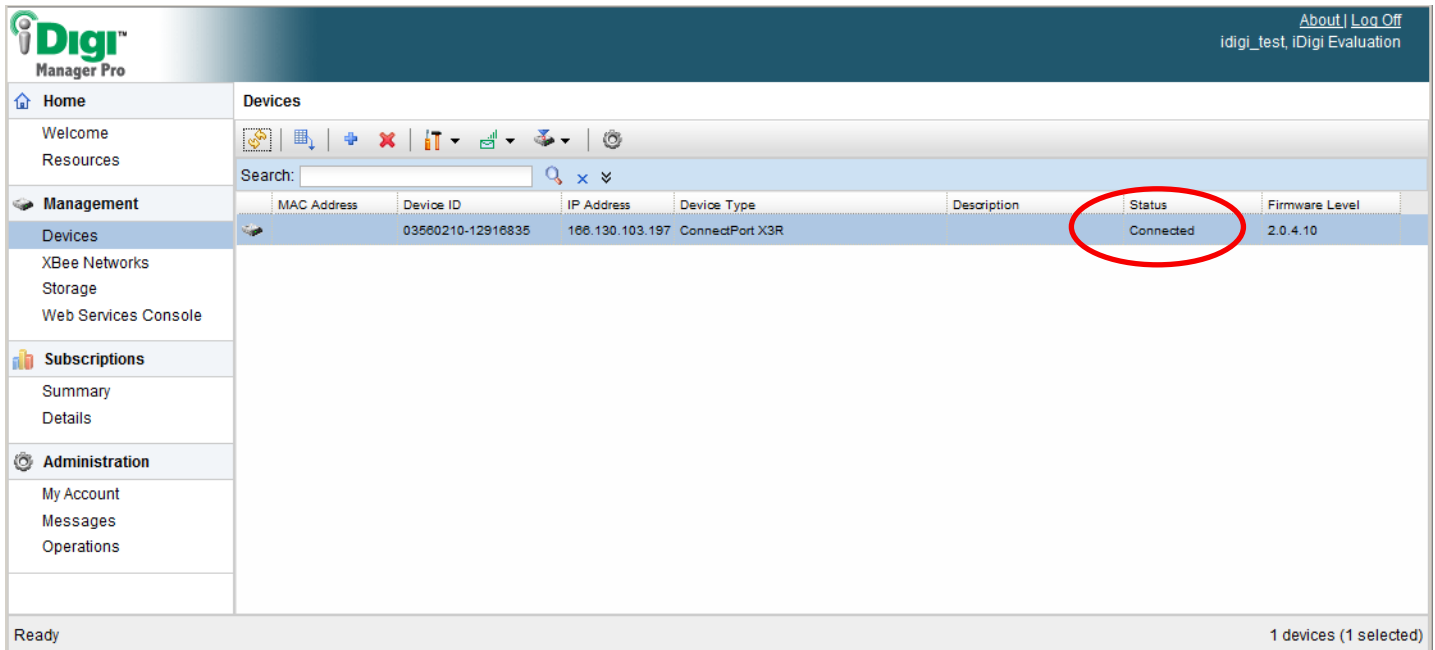

The screenshot displays the iDigi Manager Pro web interface. The top navigation bar includes the iDigi logo and links for 'About' and 'Log Off'. The main content area is titled 'Devices' and features a search bar and a table of device information. The table has columns for MAC Address, Device ID, IP Address, Device Type, Description, Status, and Firmware Level. A single device is listed with the status 'Connected', which is highlighted with a red circle. The bottom status bar indicates 'Ready' and '1 devices (1 selected)'.

MAC Address	Device ID	IP Address	Device Type	Description	Status	Firmware Level
	03560210-12916835	106.130.103.197	ConnectPort X3R		Connected	2.0.4.10

For more information about the configuration settings for your ConnectPort X3 gateway, see the **ConnectPort X3 Family User's Guide**, available at <http://www.digi.com/connectportx3>.

5 Using Digi ESP™ for Python

The Digi ESP for Python IDE provides sample Python programs that can easily be downloaded to your ConnectPort X3 gateway. This section will guide you through the steps required to run your first sample project.

1. If it is not already open, launch Digi ESP for Python (**Start > Digi > iDigi > Digi ESP**).
2. Open the Digi ESP for Python Workbench (second image shown below) by clicking on the Workbench icon (as indicated in the image below).

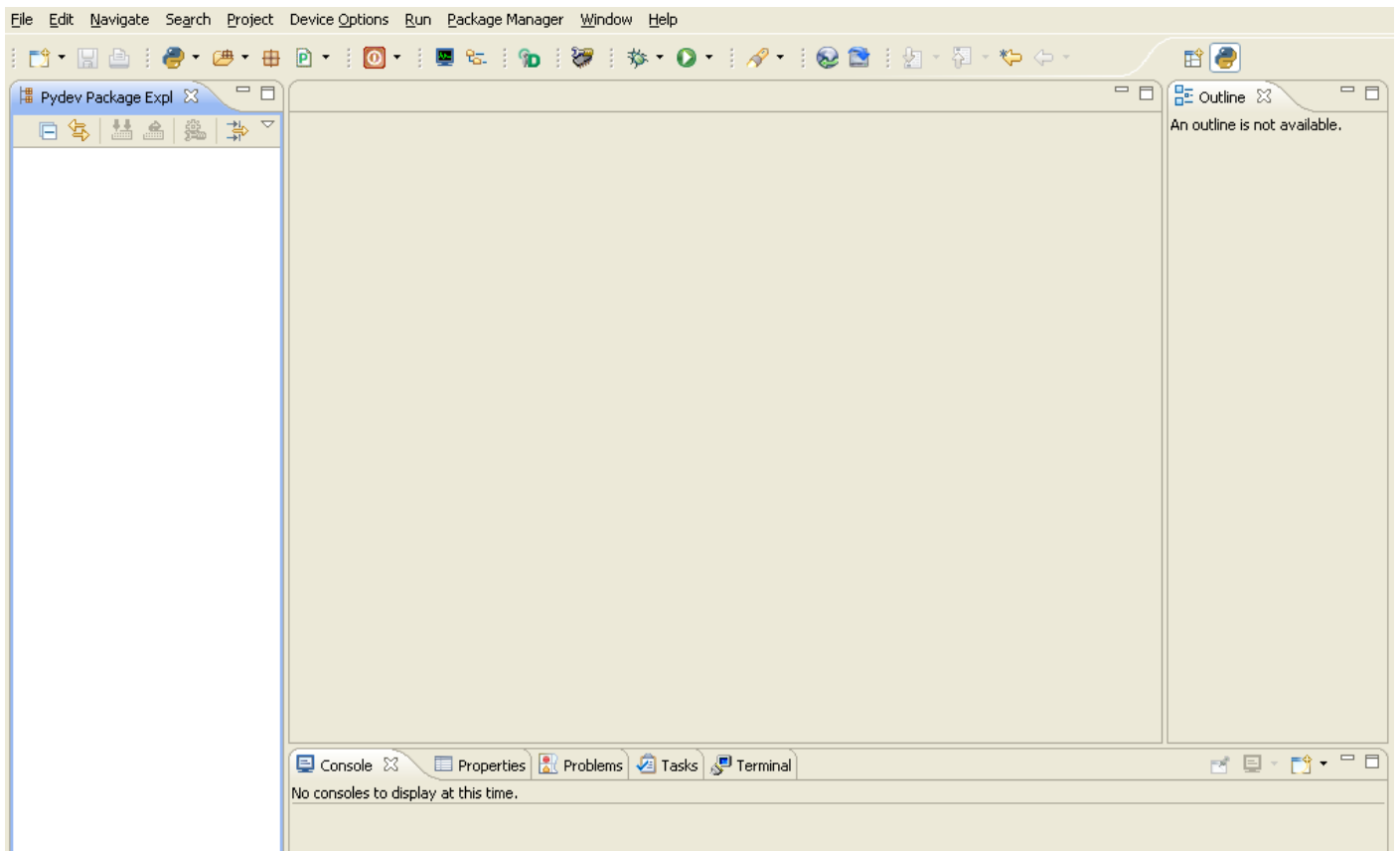
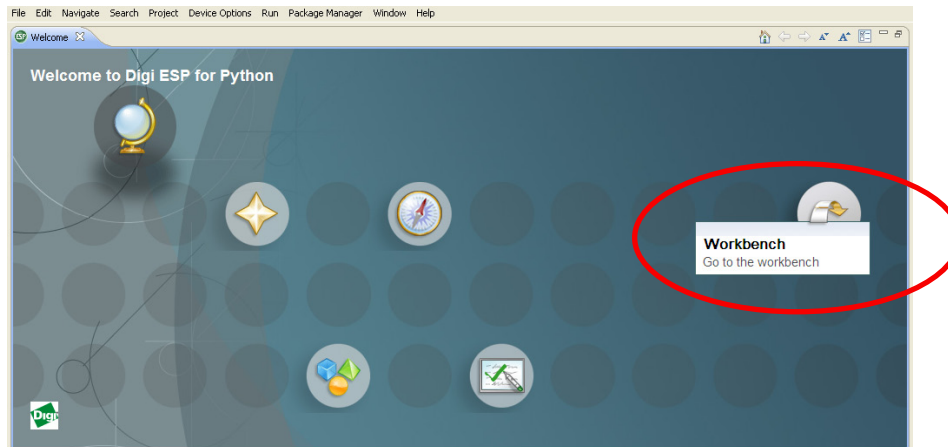

Note: If at any point you close Digi ESP for Python, it can be reopened by double-clicking on the Digi ESP for Python icon from your computer's desktop, or by navigating to **Start > Digi > iDigi > Digi ESP**.

Note: The Package Manager screen (shown below) will be displayed every time you run Digi ESP for Python (except the very first time, or until you de-select the “open this dialog at startup” checkbox).



- From the Workbench's main menu select **File > New > Digi Python Application Sample Project** to open the Digi Python Application Sample Project Wizard. The Sample Selection wizard page will be displayed (as shown below).

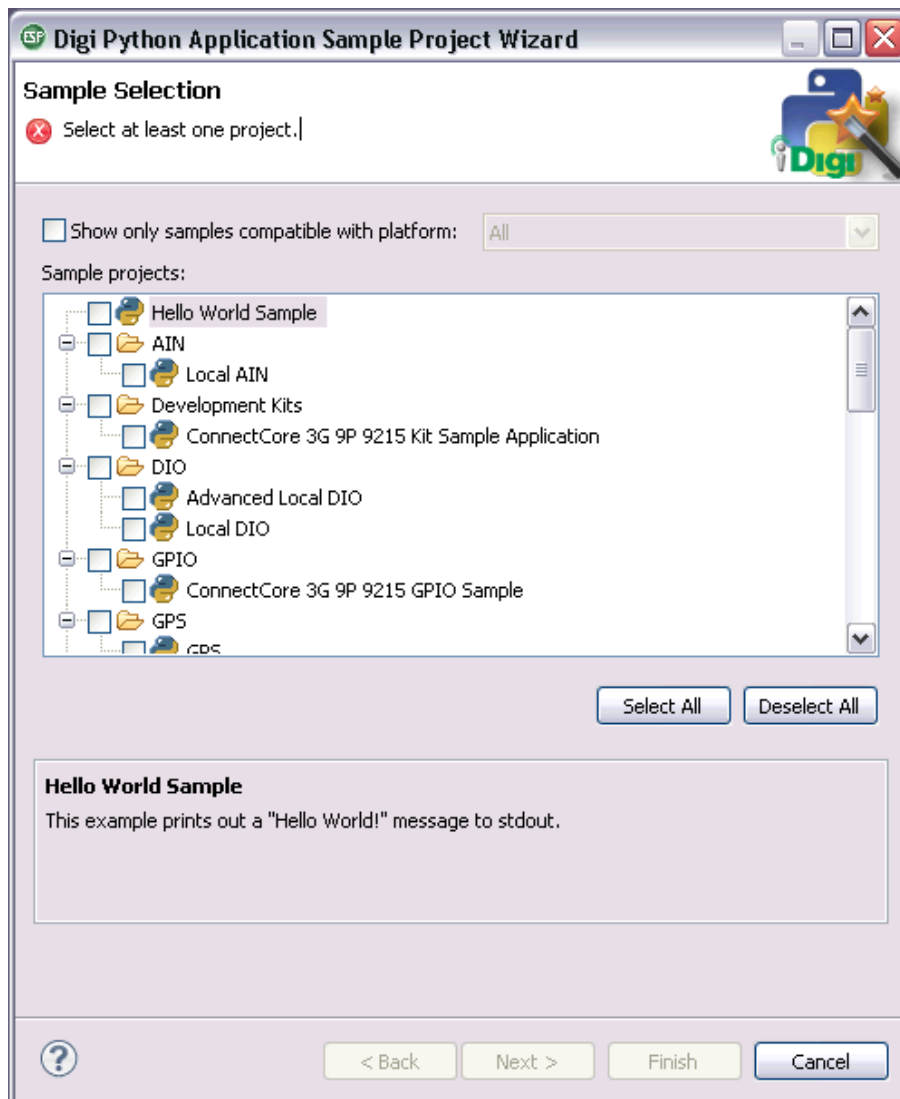

- Click to enable the 'Show only samples compatible with platform:' checkbox, then select your ConnectPort X3 gateway from the drop-down menu. For the example used in this guide, the **ConnectPort X3 R** gateway is selected.
- Locate **iDigi GPS Sample** within the sample projects list, then click its checkbox to enable the sample project. Click **Next** when finished.

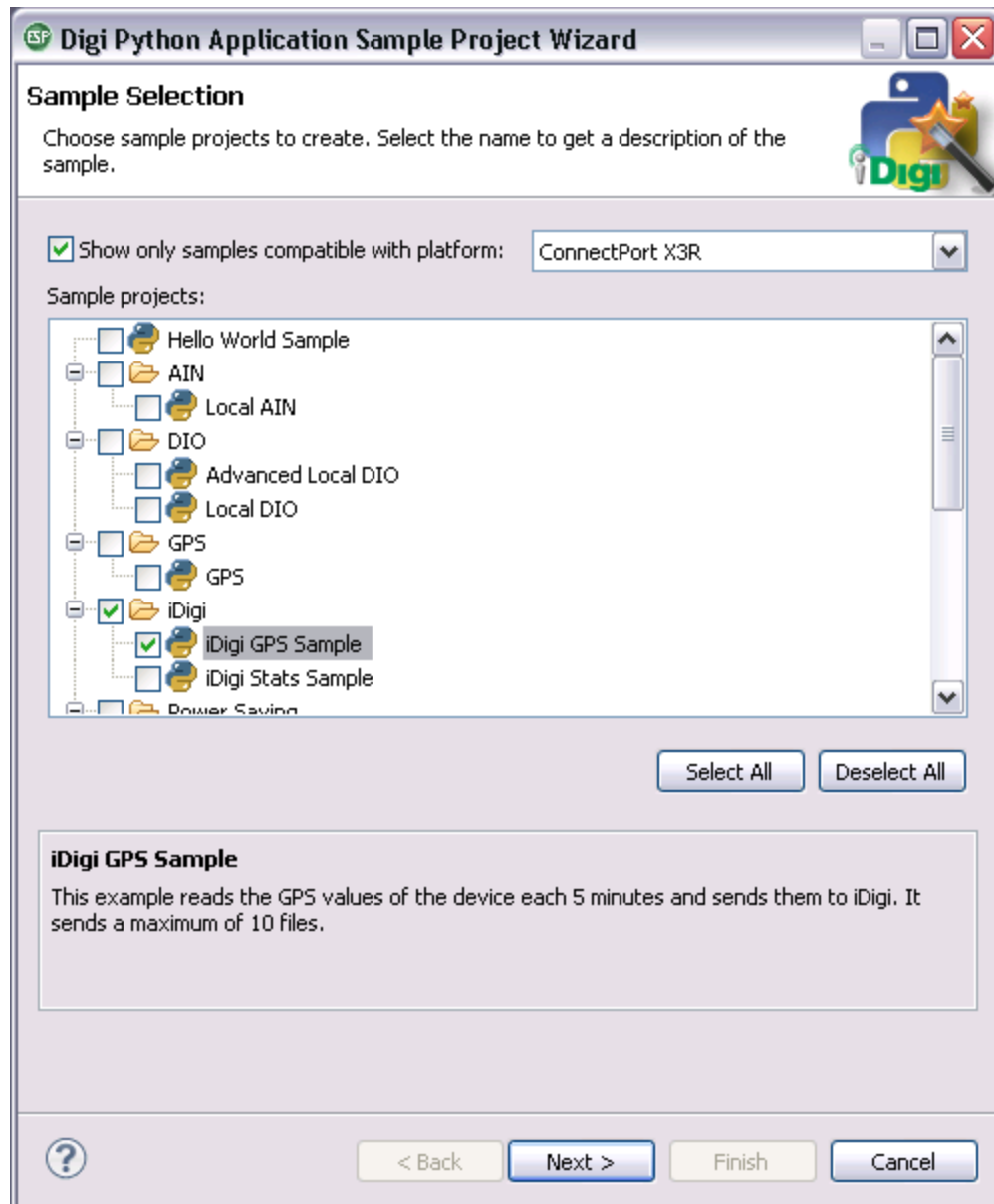

6. Within the Remote Device Selection wizard page, ensure that **Use Current Remote Configuration** is selected and then click the **New...** button to create a new remote configuration.

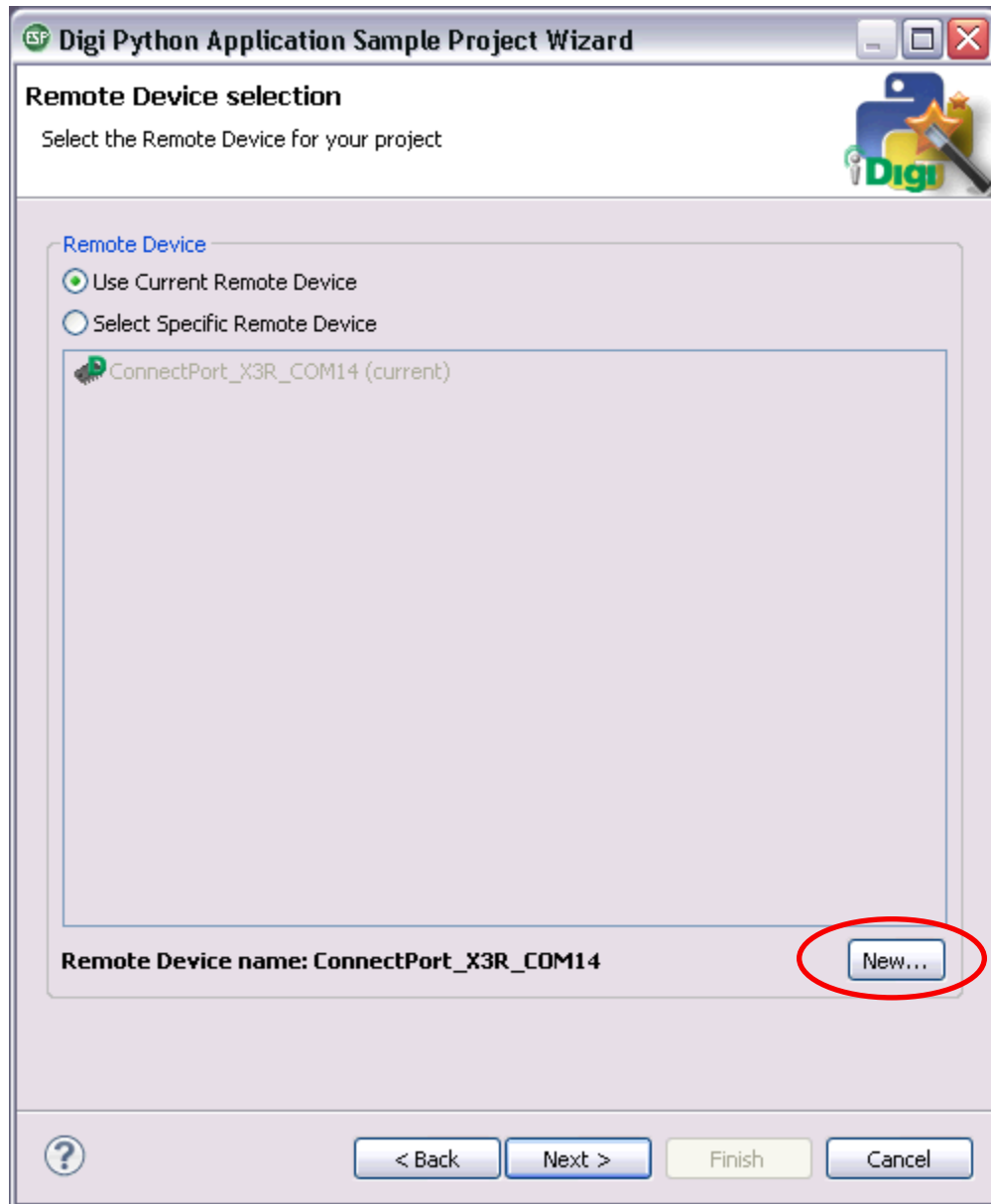

- a. After clicking the New... button, the Device Manager wizard dialog will open. Click on the **Device Discovery** button.

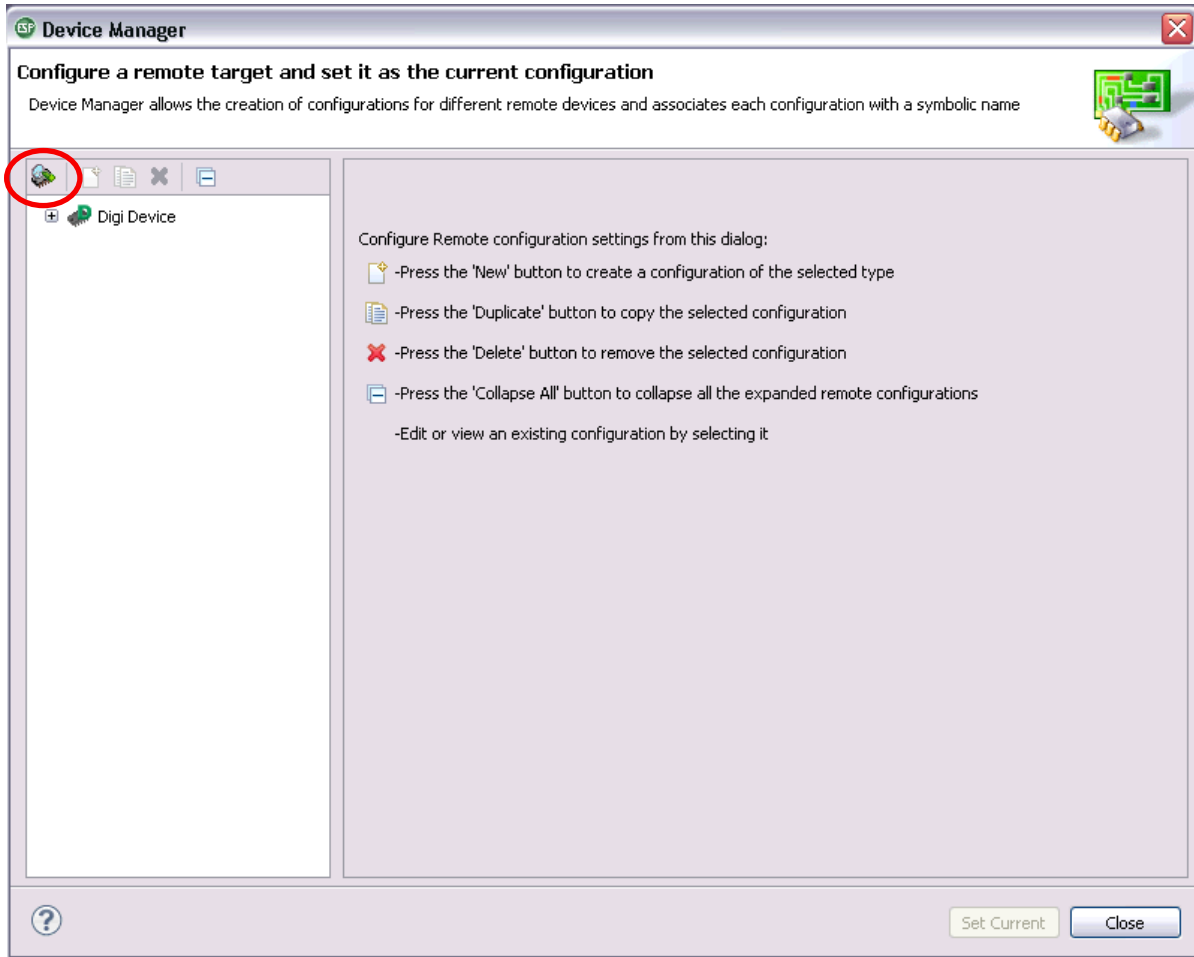

- b. A dialog will ask you to identify a location where the Digi ESP for Python framework should look for devices. Select **Local area network / USB / UART devices**. Click **OK** when finished.

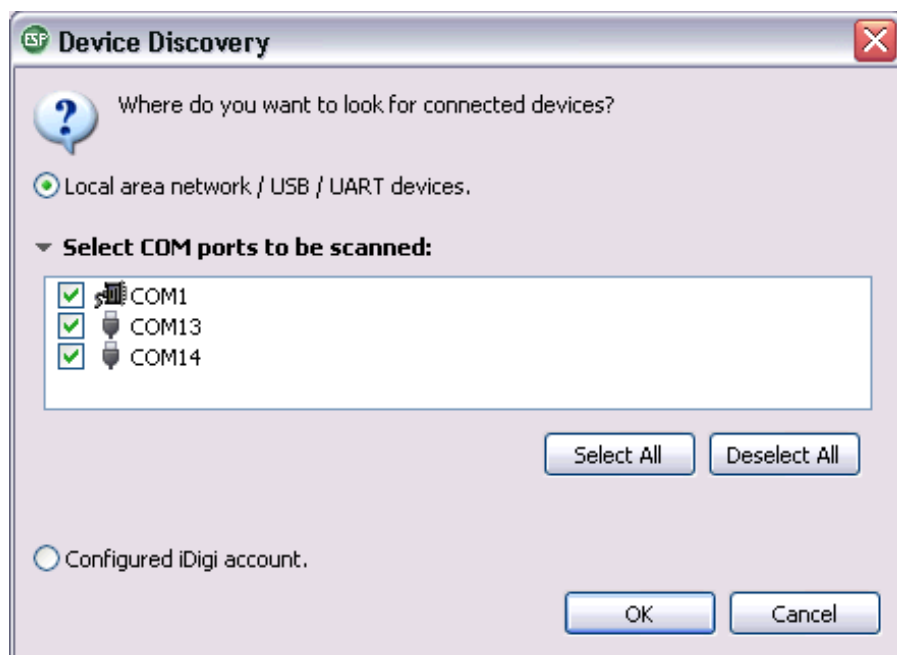

- c. A progress dialog is displayed, indicating that the Digi Device Discovery utility is searching for devices. When the search is finished the **Digi Device Discovery** dialog is displayed listing all the Digi devices discovered on your local network.

Note: The image below is for reference purposes. You will have fewer (possibly only one) devices in your device list.

- d. Click on your device to select it from the list, and then click the **Create Configuration** button.

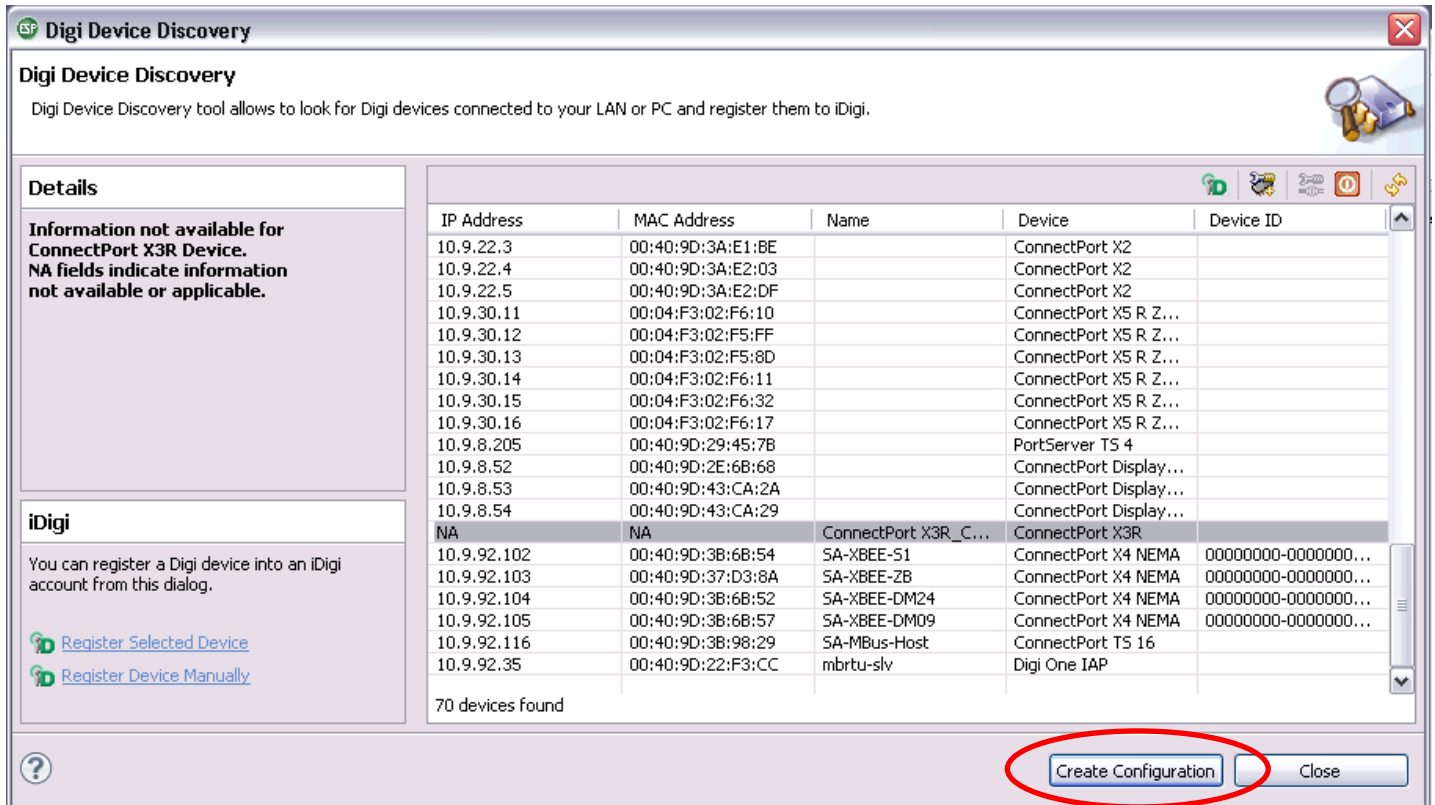

- e. Ensure that your ConnectPort X3 gateway is displayed in the 'Select the connected device type from the list:' drop-down menu. For the example used in this guide, the **ConnectPort X3 R** gateway should be displayed.

Note: The name of your ConnectPort X3 gateway should be automatically populated in this drop-down list. Only change the 'Select the connected device type from the list:' value if your specific ConnectPort X3 gateway is not displayed.

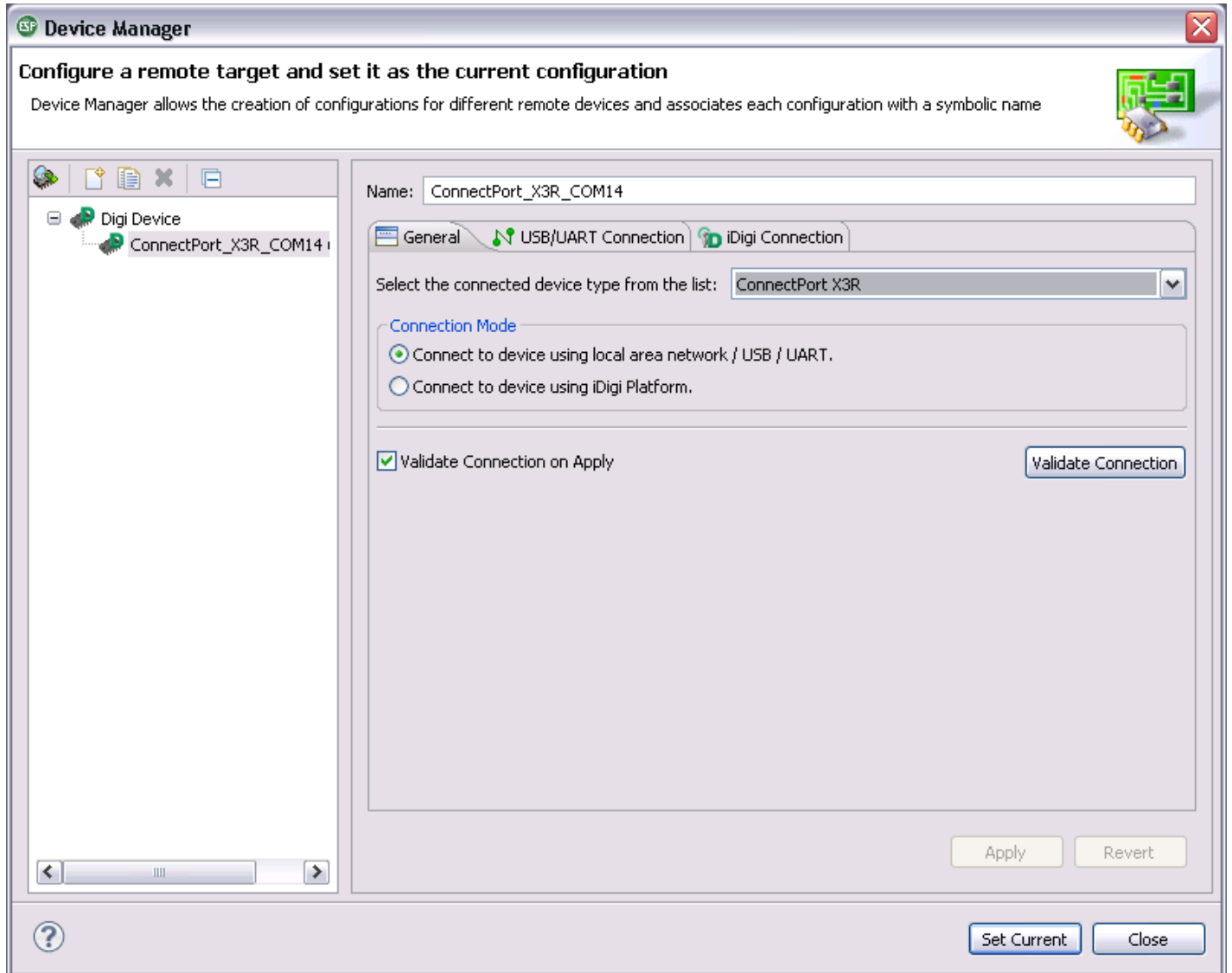

- f. Click on the **USB/UART Connection** tab. Verify that your COM port is selected from the 'Select the COM Port connected to the device' drop-down menu, then change the 'Reboot TimeOut (seconds)' field to **60** seconds.

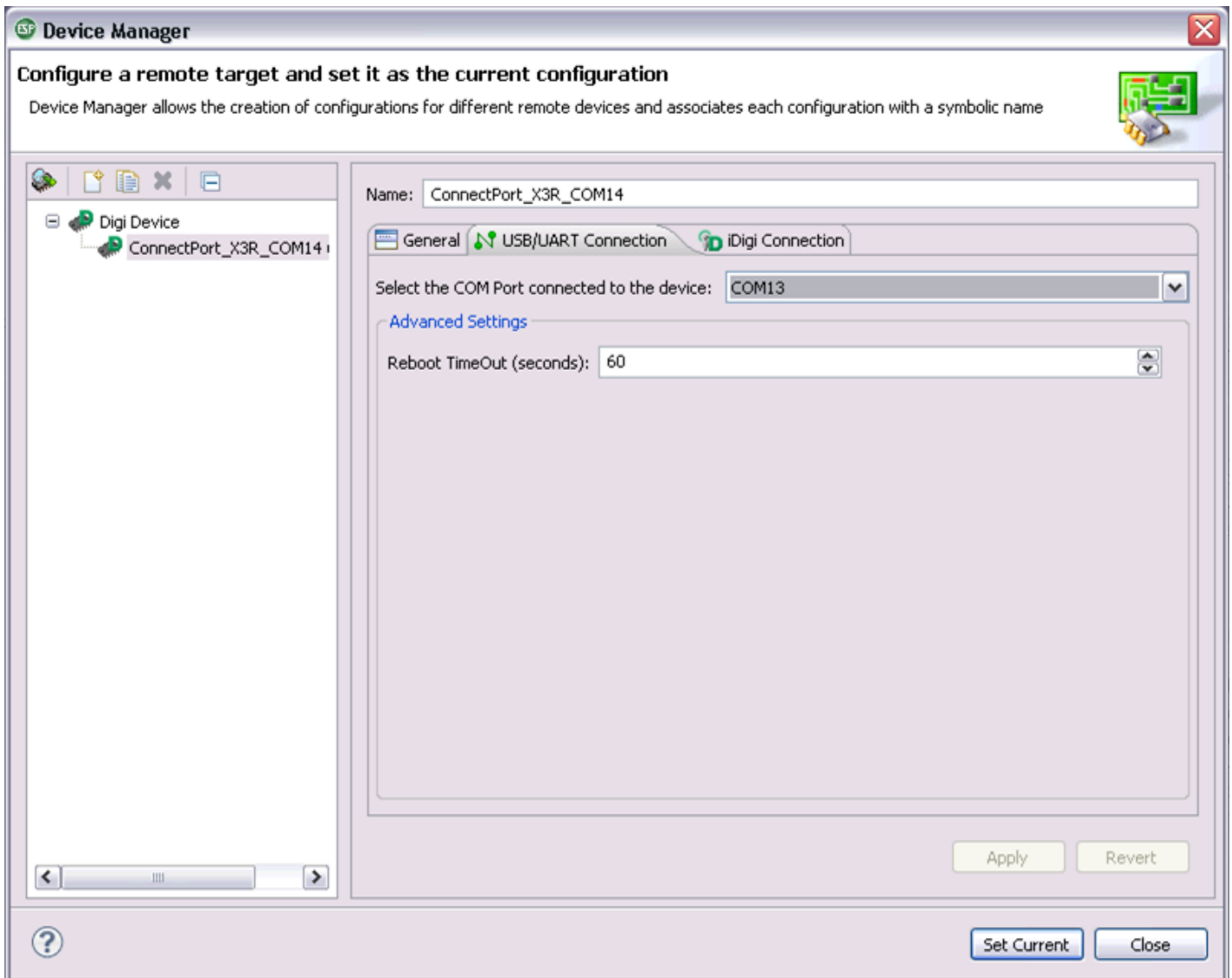

- g. Click on the **iDigi Connection** tab. Enter the Device ID of your ConnectPort X3 gateway into the 'Device ID' field. This can be done using two methods:
- Locate the Modem Serial Number (IMEI or MEID) of the device (found on the side label of the device) and enter this number into the 'Device ID' field.
 - Open the Digi X3 Dashboard (**Start > Digi > Digi X3 Dashboard > Digi X3 Dashboard**). Ensure that the Device Information tab is displayed. Copy and paste the number listed in the 'Serial Number ([IMEI])' field into the 'Device ID' field of the Digi Device Manager.

Next, enter your iDigi developer account user name and password into the 'User name' and 'Password' fields. Ensure that `developer.idigi.com` is typed into the 'Host Name' field, then click **Apply**.

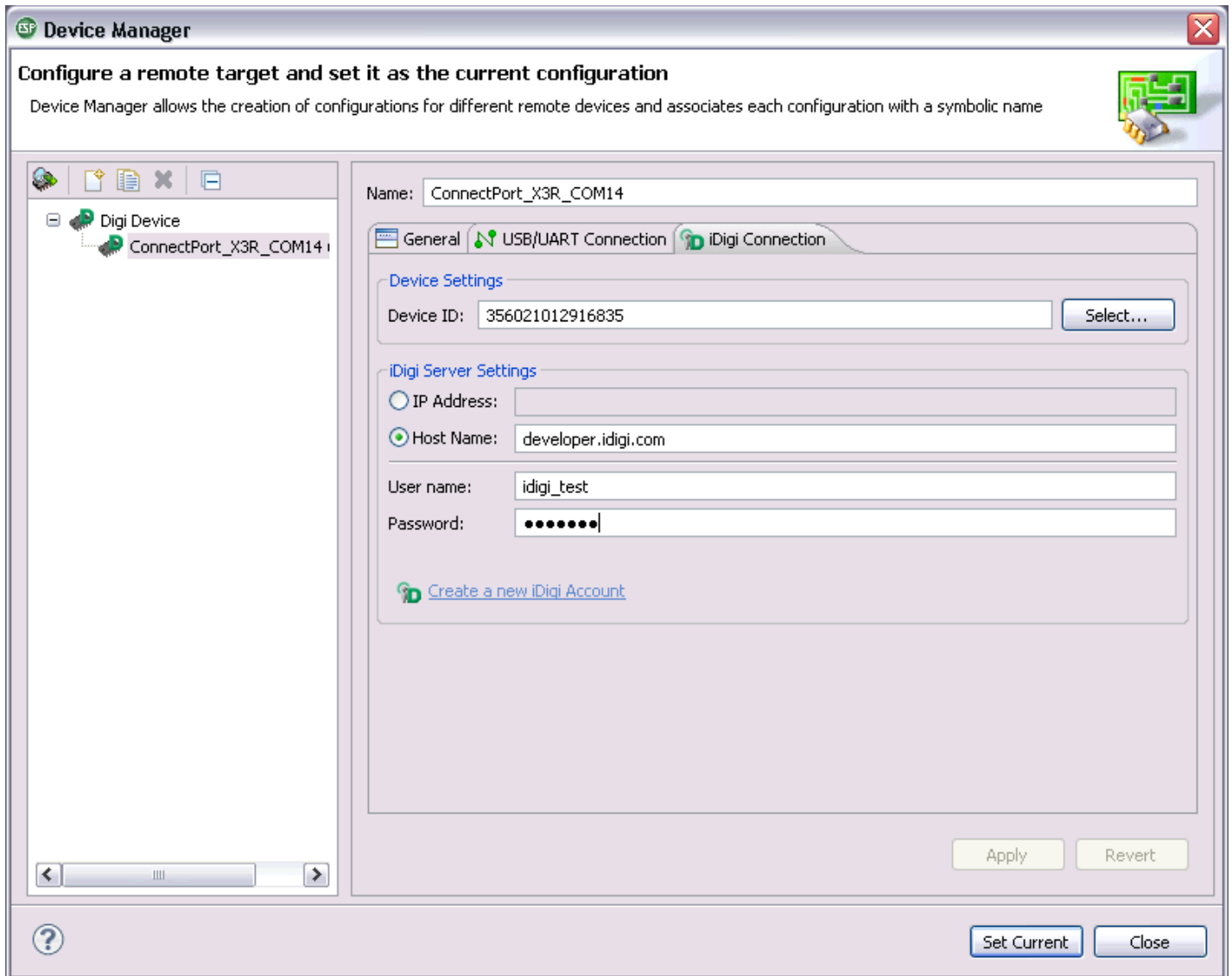

- h. Click the **Set Current** button to make this configuration the current one, which means that the Digi ESP for Python framework will use it to perform several operations that require interaction with the remote device (reboot, transfer files, etc.).
7. After clicking the Set Current button you will be redirected back to the Digi Python Application Sample Project Wizard. Make sure that **Use Current Remote Device** is selected, and click **Next**.

- When the Remote Device's Information wizard page is displayed, click **Next**.

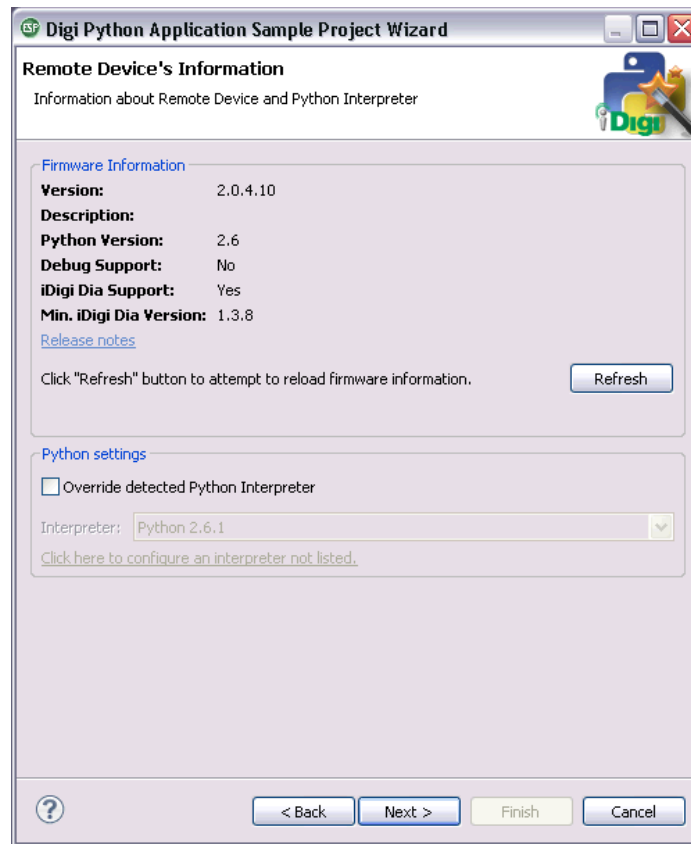

- When the Review wizard page is displayed, click **Finish**.

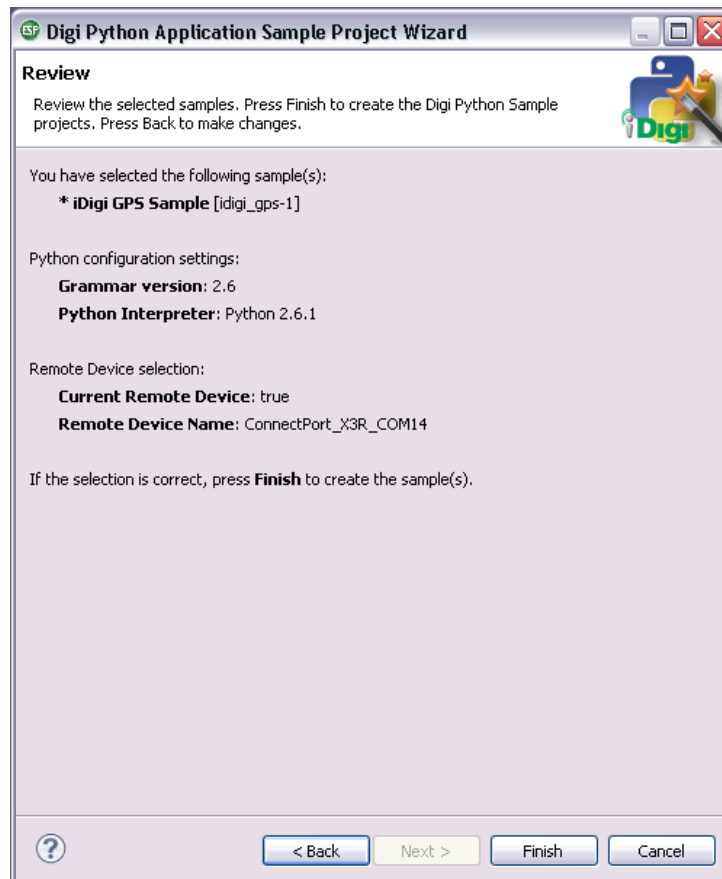

Once the wizard closes your selected project, **idigi_gps**, will be displayed in your Digi ESP for Python workbench's workspace.

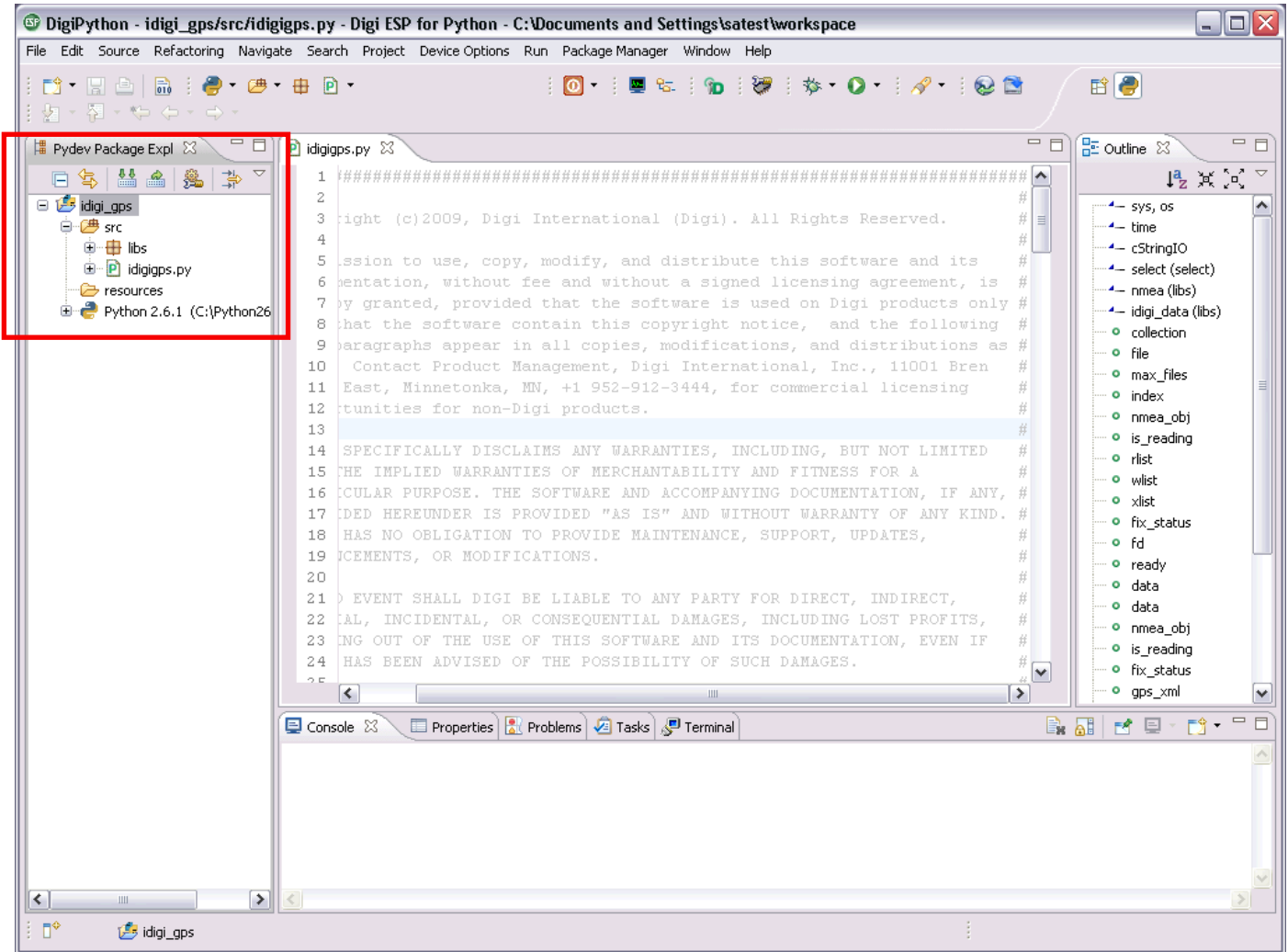

10. You are now ready to run your sample project. Using the **Run As** button's drop-down menu (shown below) go to **Run As > Remote iDigi Python Application**.

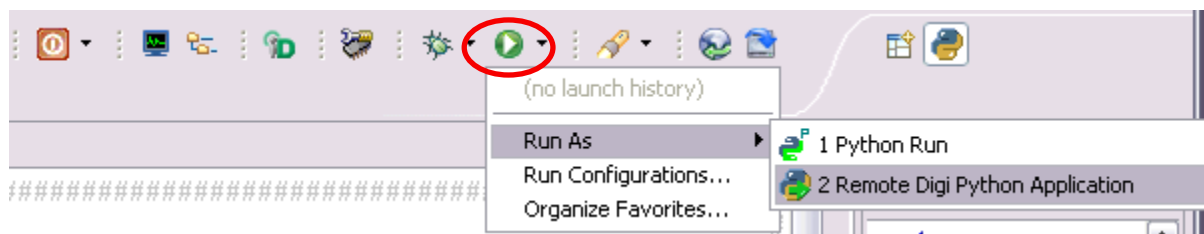

The Source View region of the Workbench screen (highlighted below) will display status messages as the project builds, downloads files to your ConnectPort X3 gateway, reboots your ConnectPort X3 gateway (in order to start the application), and finally starts sending GPS application data to your ConnectPort X3 gateway.

A total of 10 GPS data messages will be sent, one every 5 minutes for a total of 50 minutes. You will view this GPS data in the next section of this document.

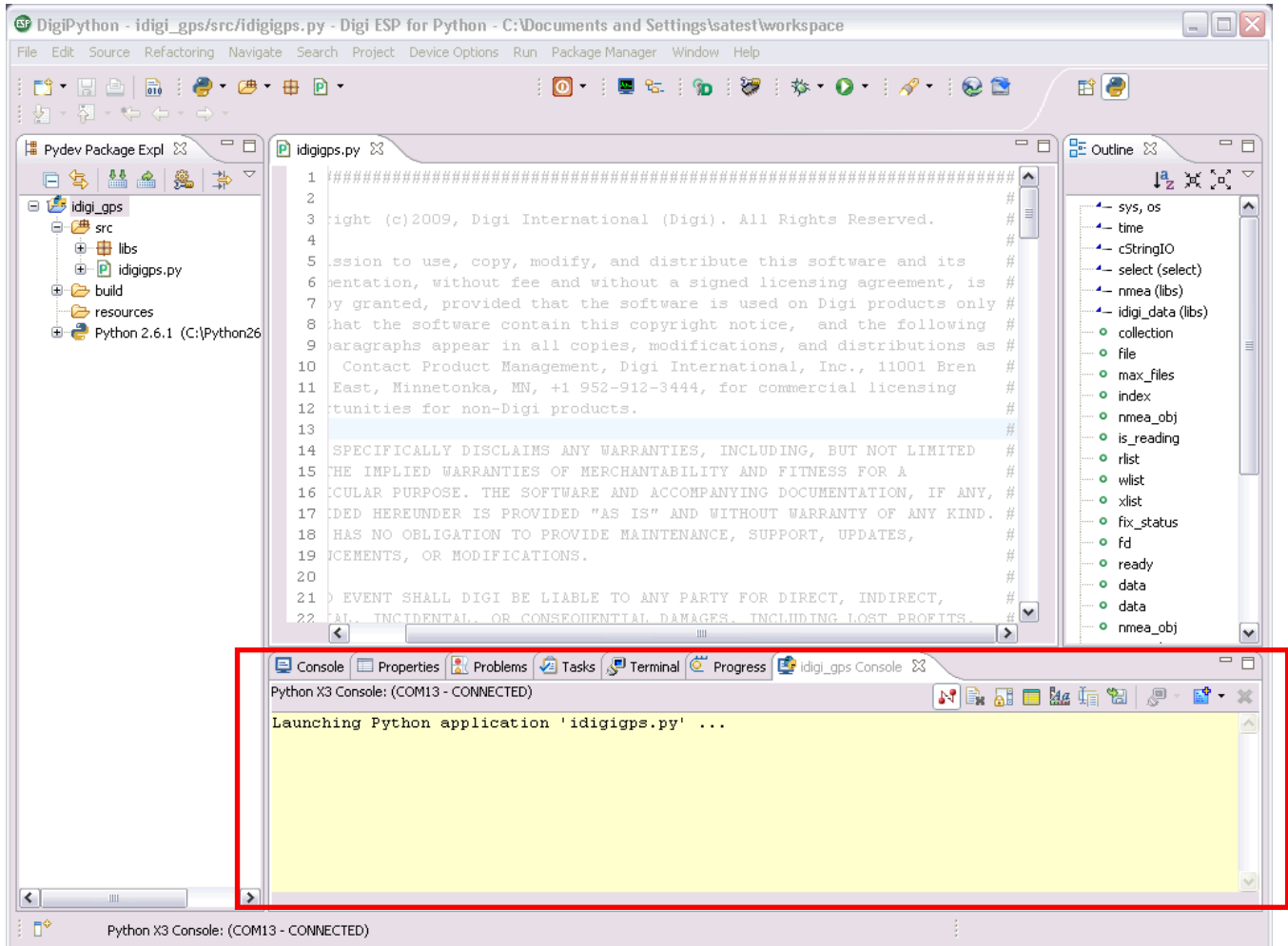

6 Viewing Uploaded Data on iDigi®

Each of the 10 data messages sent from your ConnectPort X3 gateway to the iDigi Developer Cloud can be viewed in their entirety using iDigi Manager Pro. This section will guide you through the steps required to view your uploaded GPS data.

1. Log into iDigi Manager Pro using your iDigi developer account credentials.
2. Click on **Storage** from within the left navigation panel.

The screenshot shows the iDigi Manager Pro interface. The top navigation bar includes the iDigi Manager Pro logo and links for 'About' and 'Log Off'. The user is logged in as 'idigi_test, iDigi Evaluation'. The left navigation panel is expanded to show the 'Storage' section. The main content area, titled 'Data files and folders', displays a table with one data folder.

Name	Last Modified Date	Size
00010000-00000000-03560210-12916835	4/19/11 9:43 AM	

At the bottom of the interface, the status bar shows 'Ready' on the left and '1 items' on the right.

A data folder containing your GPS data will be displayed. The name of the folder is the full iDigi Device ID of your ConnectPort X3 gateway.

3. Double-click on the data file to open it, then double-click on the **device_gps** data file to open its individual data messages.

- 10 data entries are displayed, indicating that your sample program ran for an entire 50 minute session.

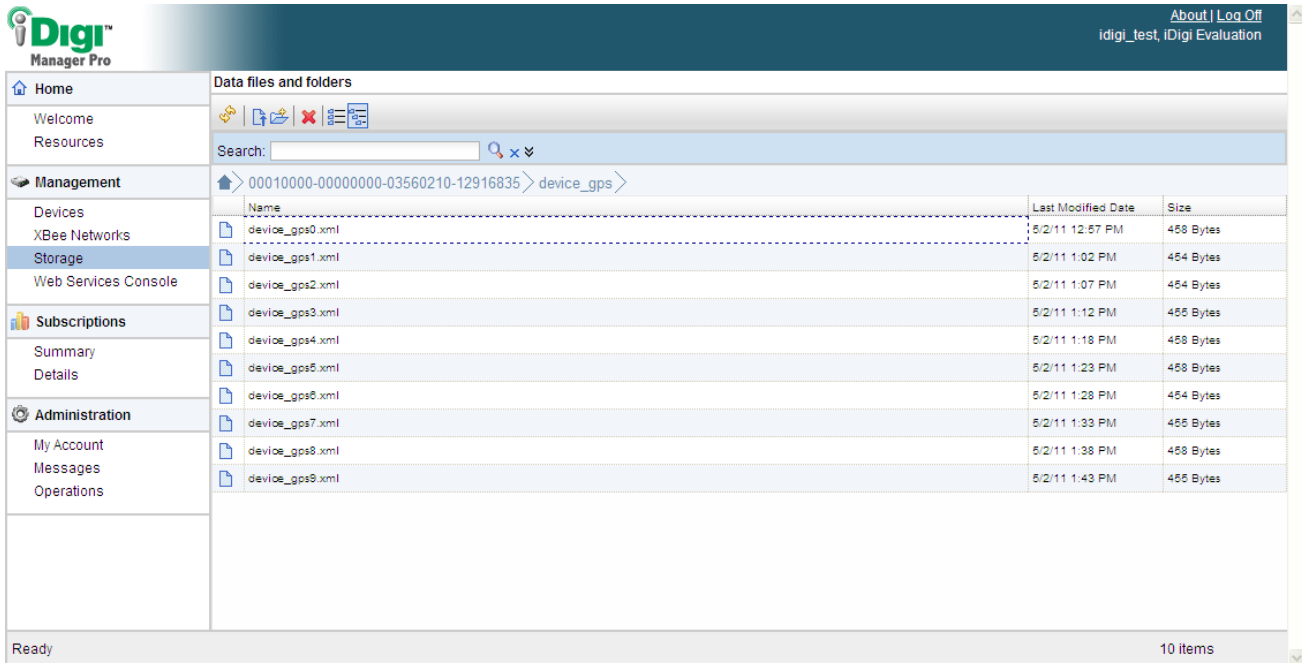

- Double-click on one of the files to display its contents; for example the GPS positioning information from the ConnectPort X3 gateway.

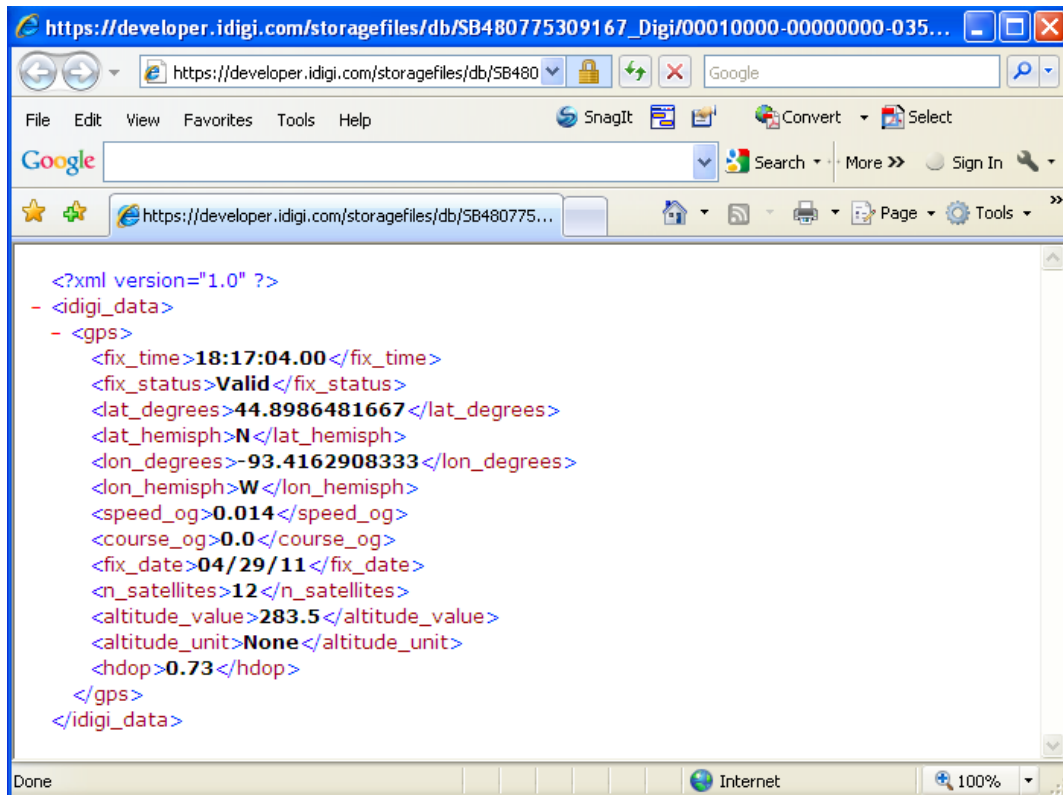

This is the end of the Digi ESP for Python Application Sample Project demonstration.

You can rerun the sample program at any time by repeating Step 10 of Chapter 5, and its subsequent steps. To stop a running a Python Program, simply click the  **Reboot Target** button.

Copyright

© 2011 Digi International Inc.
All rights reserved.

Digi, Digi International, the Digi logo, a Digi International Company, the Digi web site, iDigi, iDigi Dia, iDigi Manager Pro, iDigi Device Cloud, iDigi Developer Cloud, Digi Connect, ConnectPort X, XBee, and Digi ESP are trademarks or registered trademarks of Digi International, Inc. in the United States and other countries worldwide.

All other trademarks are the property of their respective owners.

Information in this document is subject to change without notice and does not represent a commitment on the part of Digi International.

Digi provides this document “as is,” without warranty of any kind, either expressed or implied, including, but not limited to, the implied warranties of fitness or merchantability for a particular purpose. Digi may make improvements and/or changes in this manual or in the product(s) and/or the program(s) described in this manual at any time.

This product could include technical inaccuracies or typographical errors. Changes are periodically made to the information herein; these changes may be incorporated in new editions of the publication.

No part of this document covered by copyright may be reproduced or copied in any form or by any means graphic, electronic, or mechanical, including photocopying, recording, taping, or information and retrieval systems without written permission of Digi International.



Digi International

11001 Bren Road East

Minnetonka, MN 55343

952-912-3444 or 877-912-3444