

SECTION A-A  
SCALE 5:1

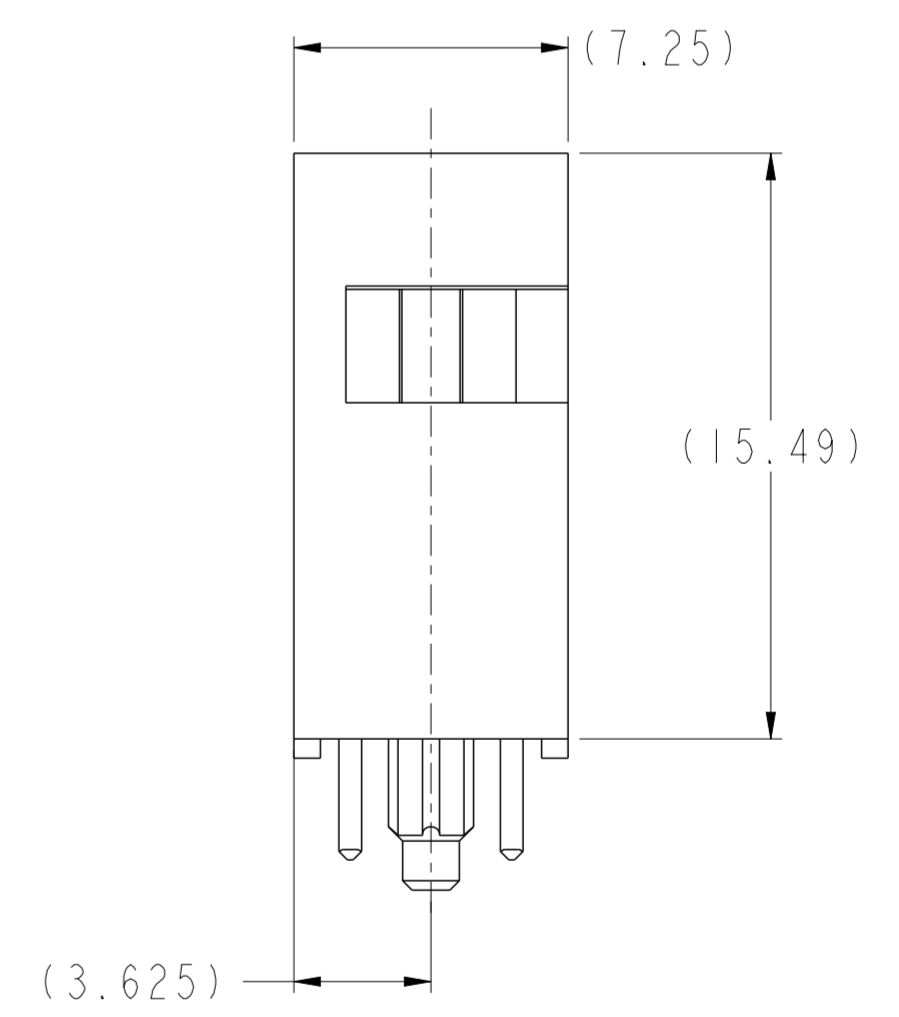
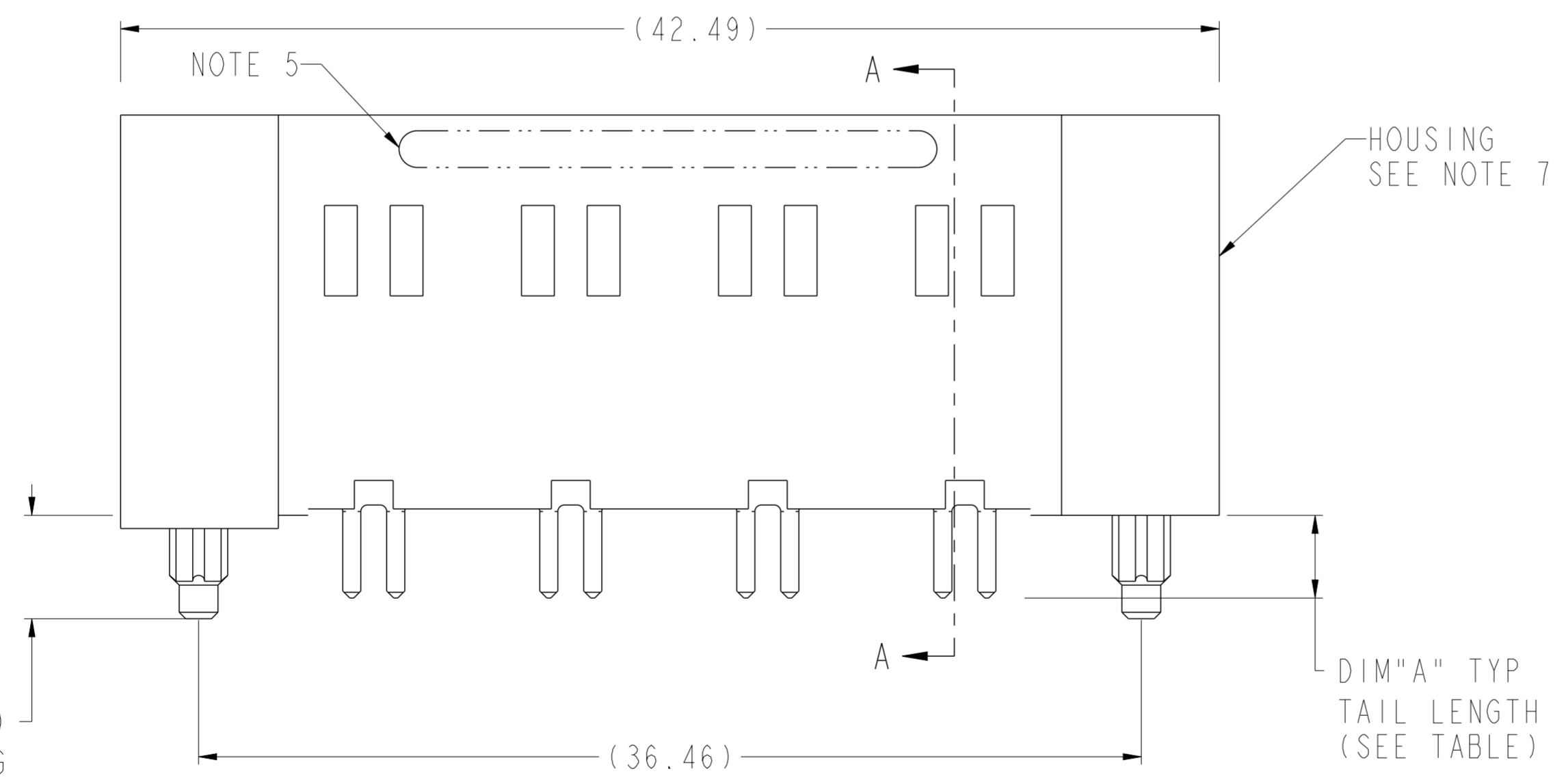

Copyright FCI.

spec ref	-	dr	Liu Jenson	2013/09/26	projection	mm	size	A2	scale	5:1	
tolerance std	ASME Y14.5	eng	Liu Jenson	2014/04/22			ecn no	ELX-DG-17541-1			
TOLERANCES UNLESS OTHERWISE SPECIFIED		chr	Jon Qin	2014/04/25			rel level	Released			
surface	ASME Y14.5	appr	Collins Lu	2014/04/25			product family	-			
linear	0.X ±0.3 0.XX ±0.10 0.XXX ±0.050			title	VERTICAL HEADER 16P(HP) HPCE CTB VERTICAL - HEADER		dwg no	10127417		rev	B
angular	0° ±2°	www.fci.com		cat. no.	-		Product - Customer Drw	sheet 1 of 3			

PDS: Rev :B

STATUS:Released

Printed: Apr 25, 2014

CONTACT TYPE	TOP LAYER DESCRIPTION	TABLE 1 (HPCE / SOLDER TAILS) PLATED THROUGH-HOLE REQUIREMENTS				
		DRILLED HOLE DIAMETER	COPPER THICKNESS	TIN-LEAD THICKNESS	TIN THICKNESS	FINISHED HOLE DIAMETER
POWER & SIGNAL	TIN-LEAD	1.10-1.16 (1.15 DRILL)	0.025 - 0.050	0.005 - 0.015	--	0.94 - 1.10
	IMMERSION TIN	1.10-1.16 (1.15 DRILL)	0.025 - 0.050	--	0.9 - 1.5um	0.94 - 1.10
	COPPER (SEE NOTE 8)	1.10-1.16 (1.15 DRILL)	0.025 - 0.050	--	--	0.94 - 1.10

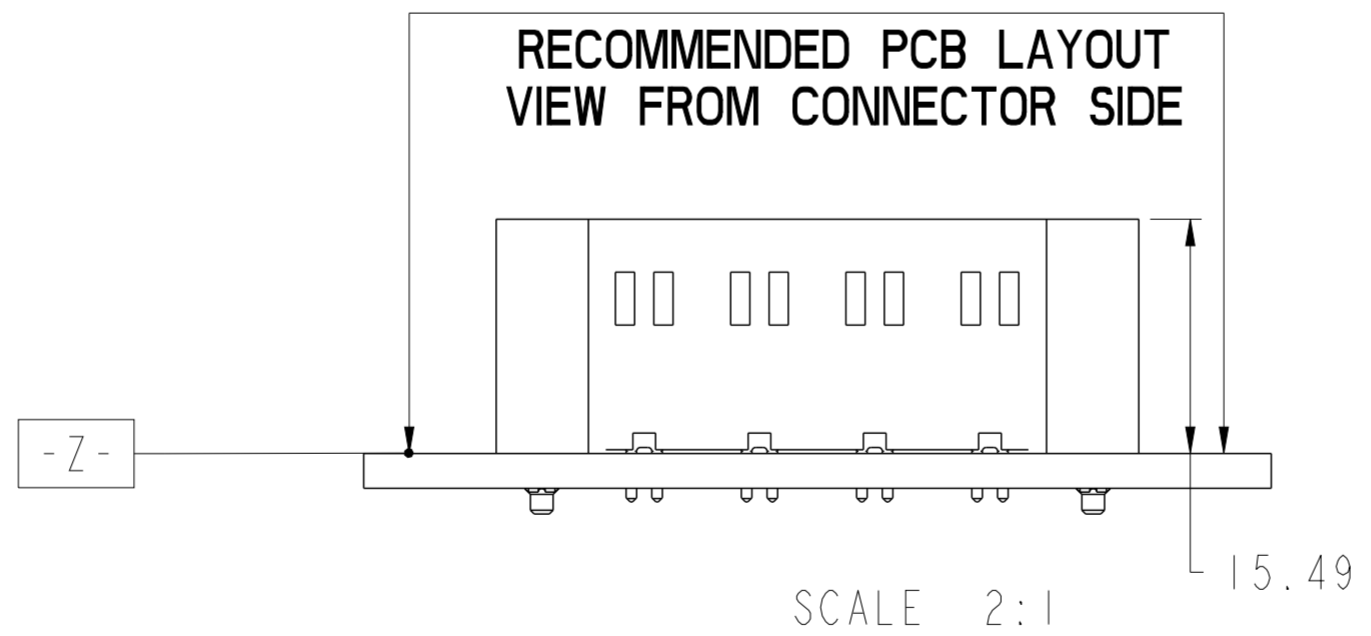
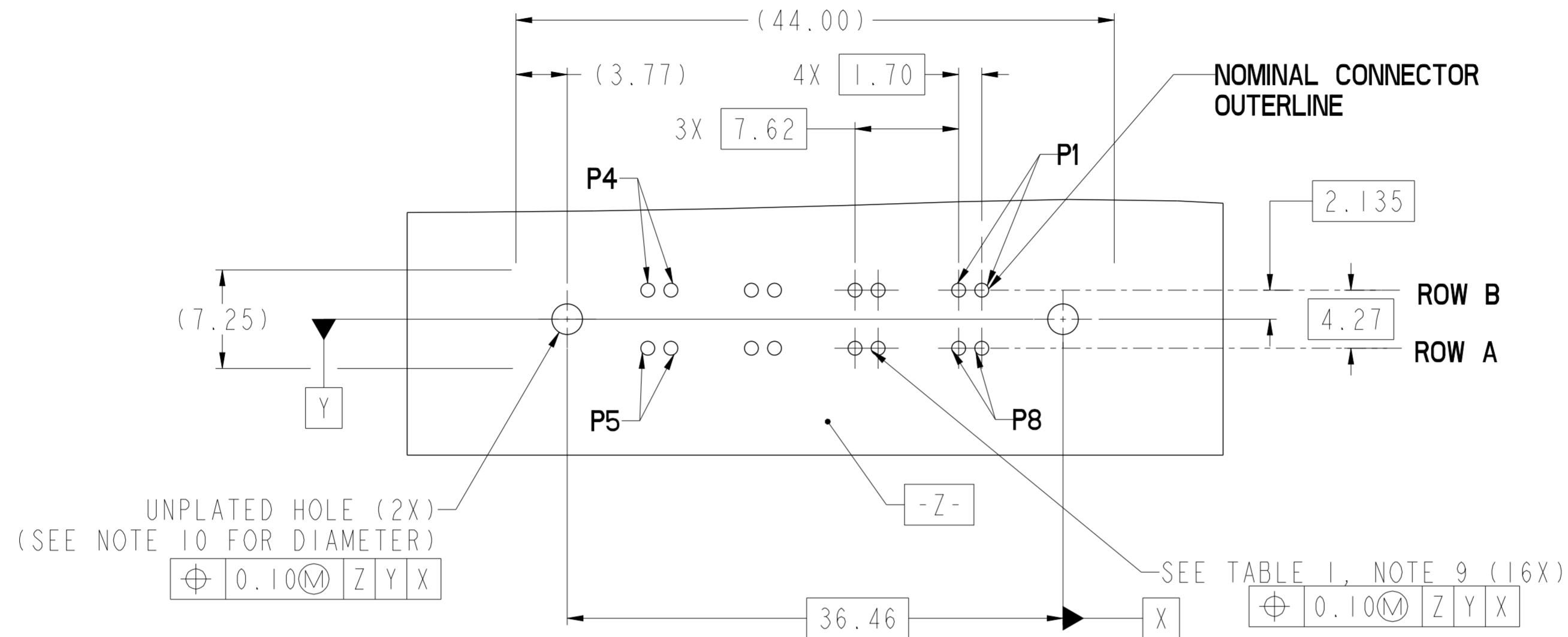

spec ref	-	dr	Liu Jenson	2013/09/26	projection	mm	size	A2	scale	3:1
tolerance std	ASME Y14.5 ISO 1101	eng	Liu Jenson	2014/04/22		mm	ecn no	ELX-DG-17541-1	rel level	Released
TOLERANCES UNLESS OTHERWISE SPECIFIED		chr	Jon Qin	2014/04/25						
surface		appr	Collins Lu	2014/04/25						
linear	0.X ±0.3 0.XX ±0.10 0.XXX ±0.050			product family	VERTICAL HEADER 16P(HP)	cat. no.	10127417	rev	B	
angular	0° ±2°	www.fci.com		Product - Customer Drw	sheet 2 of 3					

PRODUCT PART NUMBER

10127417-□□□□□LF

BASE PART NUMBER

CONTACT AREA PLATING  
 UNDERPLATED 50u"(1.27um) MIN. NICKEL  
 1: 100u"(2.5um) MIN. Ag  
 2: 30u"(0.760um) MIN. GXT

FIRST MATE LAST BREAK PIN POSITION  
 000: ALL PINS ARE LONG PINS SEE TABLE

DIM "A", TAIL LENGTH  
 1: 2.60±0.25mm (PCB THK 1.57±0.13mm)  
 2: 3.25±0.25mm (PCB THK 2.36±0.13mm)

000	END MODULE	POWER CONTACT					END MODULE
		4	3	2	1		
		P3	P3	P3	P3	ROW A	
		P3	P3	P3	P3	ROW B	

POWER CONTACT	ROW#	P#	DIM "C"±0.25	DIM "A"±0.25
ROW A		P1	8.86	3.25
		P2	7.59	3.25
		P3	8.86	2.60
		P4	7.59	2.60
		P9	8.86	3.25
		P10	7.59	3.25
ROW B		P1	8.86	3.25
		P2	8.86	3.25
		P3	7.59	2.60
		P4	7.59	2.60
		P9	8.86	3.25
		P10	7.59	3.25

NOTES:

1. CONNECTOR MATERIALS:

HOUSING: HIGH TEMPERATURE THERMAL PLASTIC, BLACK UL 94V-0 COMPLIANT

CONTACTS: HIGH PERFORMANCE COPPER ALLOY.

2. CONTACT FINISH REF. GS-12-1031 SECTION 5.2

3. PRODUCT SPECIFICATION: GS-12-1031

4. APPLICATION SPECIFICATION: GS-20-0369

⑤ PRODUCT MARKING (FCI PART NUMBER & DATE CODE) ON HOUSING IN AREA SHOWN.

6. PACKAGING MEETS FCI SPECIFICATION GS-14-2272 



⑦ HOUSING COMPONENT WILL WITHSTAND EXPOSURE TO 260°C PEAK TEMPERATURE FOR 60 SECONDS IN A CONVECTION, INFRA-RED, OR VAPOR PHASE REFLOW OVEN.

⑧ COPPER PLATING THICKNESS IN CENTER OF VIA-HOLE CAN BE NO MORE THAN 0.003 LESS THAN OTHER AREAS.

⑨ ALL HOLE SIZES ARE FINISHED HOLE SIZES.

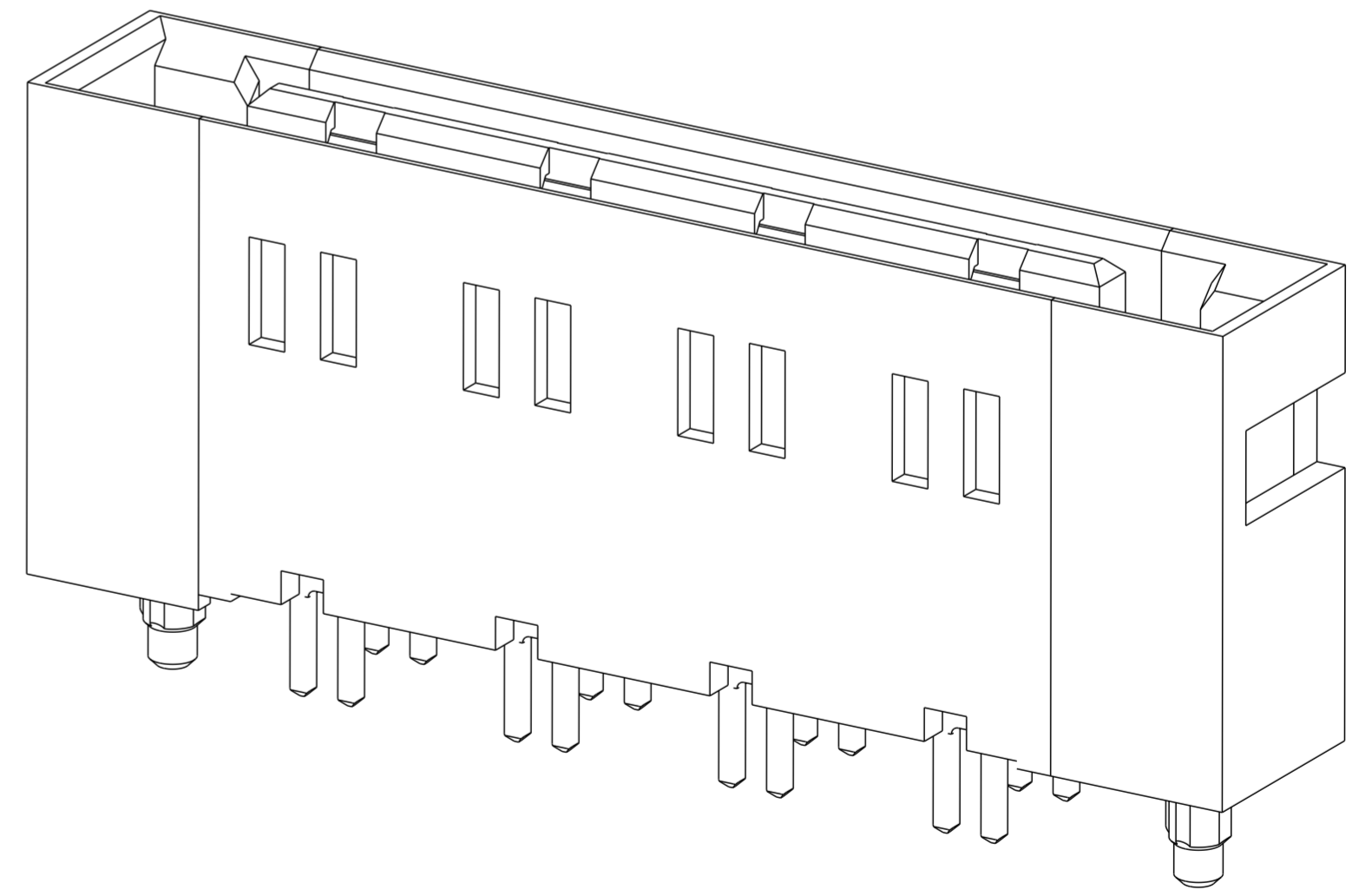
⑩ MOUNTING HOLES ARE UNPLATED  
 Ø 2.25±0.05 FOR SOLDER TAILS



spec ref	-	dr	Liu Jenson	2013/09/26	projection	mm	size	A2	scale	5:1
tolerance std	ASME Y14.5 ISO 1101	eng	Liu Jenson	2014/04/22		mm	ecn no	ELX-DG-17541-1	rel level	Released
TOLERANCES UNLESS OTHERWISE SPECIFIED		chr	Jon Qin	2014/04/25						
		appr	Collins Lu	2014/04/25						
surface	linear	0.X	±0.3		product family	-	-	-	-	-
		0.XX	±0.10							
		0.XXX	±0.050							
ASME Y14.5	angular	0°	±2°	www.fci.com	cat. no.	-	Product - Customer Drw	sheet 3 of 3		
					title	VERTICAL HEADER 16P(HP)		dwg no	10127417	
					HPCE CTB VERTICAL - HEADER			rev	B	