

PPA PRODUCTS

Datasheet & User Manual

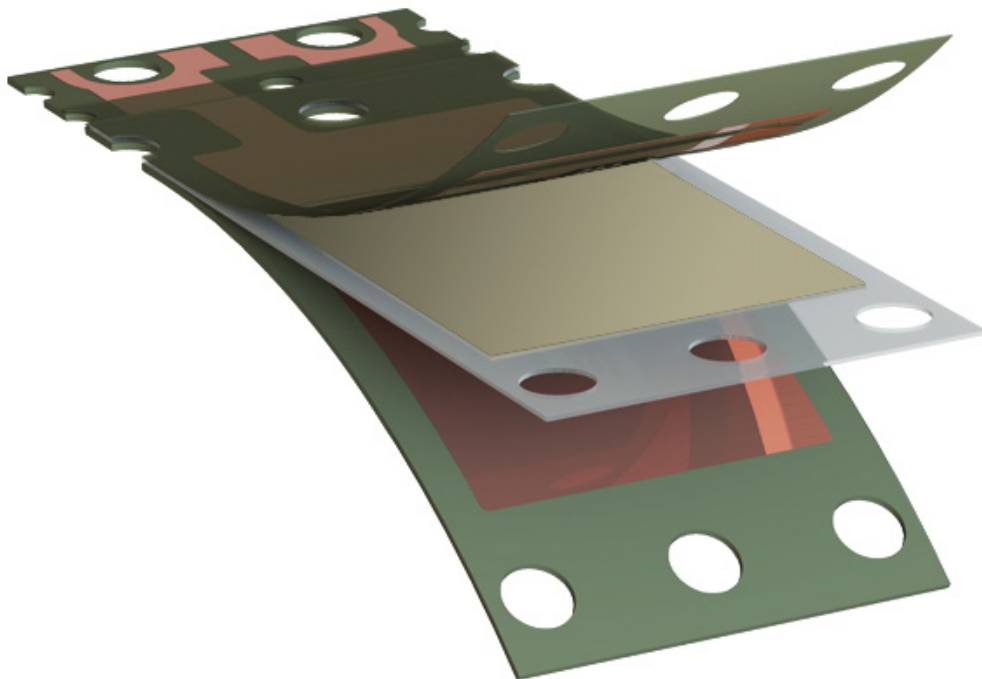

Table of Contents

0.0 General Information	4
0.1 Copyright	4
0.2 Warranty.....	4
0.3 Safety Precautions.....	4
0.4 Introduction.....	4
1.0 Product Summary	5
1.1 Overview.....	5
1.2 Volume Pricing.....	6
1.3.1 Vibration Energy Harvesting.....	7
1.3.2 Actuation	8
1.3.3. Sensing	8
1.3.4. Vibration Dampening.....	9
2.0 Product Data	10
2.1 Product: PPA-1001	10
2.2 Product: PPA-1011	14
2.3 Product: PPA-1012.....	18
2.4 Product: PPA-1013.....	22
2.5 Product: PPA-1014.....	23
2.6 Product: PPA-1021	27
2.7 Product: PPA-1022.....	31
2.8 Product: PPA-2011	35
2.9 Product: PPA-2014.....	39
2.10 Product: PPA-4011	43
3.0 Electrical Connection.....	47
3.1 Piezo Polarity & Connecting Multiple Piezos.....	47
3.2 Solder	47
3.3 PPA-7001 Ring Terminal Cable	48
3.4 Conductive Hardware Directly to PCB	48
3.5 Spring Loaded Contacts (Pogo Pins)	48
3.6 IC Hook and Alligator Clips	49
3.7 Connectors.....	49
4.0 Clamping/Mounting.....	50
4.1 PPA-9001 Clamp Kit	50
4.1.1. List of Contents.....	50
4.1.2. Clamp Location.....	51
4.1.3. Clamping Instructions.....	52
4.1.4. Example Configurations	52
4.2 PPA-9004 Clamp Enclosure Kit.....	53

4.2.1. List of Contents.....	53
4.2.2. Clamp Locations	55
4.2.3. Clamping Instructions.....	56
4.2.4. Example Configurations.....	57
4.2.5. PPA-5003 Tip Mass Accessory.....	57
4.3 PPA-5004/5/6/7 Clamp Plates.....	58
4.4 Tuning.....	60
4.4.1. Calculating the Required Tip Mass	60
4.4.2. Adding Tip Mass	60
4.4.3. Determining the Characteristics of the Vibration Source.....	61
4.4.4. Determining Resonance of the Piezo Beam.....	61
4.5 Bonding.....	61
5.0 Material Properties.....	62
5.1 Piezoelectric Properties.....	62
5.2 Packaging Materials	63
6.0 Testing Methods	64
6.1 Energy Harvesting.....	64
6.2 Static Deflection/Block Force.....	64
6.3 Frequency Sweep	65
6.4 Sensitivity/Power Bandwidth	65
7.0 Custom Solutions.....	66
8.0 Troubleshooting	67
8.1 Frequently Asked Questions.....	67
8.2 Product Support	70

0.1 COPYRIGHT

This datasheet and the design data which it describes are copyright with all rights reserved. None of the data may be copied without the express written consent of Midé Technology Corporation. Refer to Midé Technology Corporation's full Copyright Policy at http://www.mide.com/legal/legal_copyright.php for the full legal terms in regard to this copyright.

0.2 WARRANTY

Midé Technology Corporation warrants that the PPA standard products will be free from defects in workmanship and materials in normal use and operation within 3 months from date of shipment. This warranty only applies when the products are installed, maintained, and repaired in accordance with all of the directions, instructions, diagrams, safety warnings, cautions, and other notices set forth in this document, and if not damaged by persons, actions, or inactions unrelated to Midé. In the event of any such defect of which Midé is informed in writing within such 3 month period, Midé's sole responsibility is, at Midé's option, to provide a replacement at no cost to the Buyer upon the return of the defective product. Requests for compliance with this express, limited warranty shall be honored only when made by the Buyer. Refer to the Terms and Conditions at http://www.mide.com/legal/legal_terms.php#4 for the full legal terms in regard to this warranty.

0.3 SAFETY PRECAUTIONS

A number of warnings and cautions appear in the text of this technical manual. They are intended to safeguard personnel and equipment from potential hazards or damage during equipment installation, operation, and maintenance. These warnings and cautions will be presented in the following manner.

WARNING: This represents an operating procedure, practice condition, statement, etc., which if not strictly observed, could result in injury to personnel or long term health hazards.

CAUTION: This represents an operating procedure, practice condition, statement, etc., which if not strictly observed, could result in damage to, or destruction of, equipment or a reduction in performance.

In addition to the specific warnings and cautions included in this manual, Midé recommends that all customers install, operate, and maintain the products in accordance with general safety guidelines included in standards published by OSHA.

0.4 INTRODUCTION

Midé's piezo standard products utilize its Piezo Protection Advantage (PPA) to protect the piezo ceramic wafers. Midé's packaging also enables cost effective system integration with mounting features and electrical connection incorporated into the piezoelectric package. Midé has been manufacturing packaged piezos with its patented process for over 15 years; it typically produces between 25,000 and 50,000 units annually. In addition to the manufacturing experience Midé has gained over the years, it has engineered many custom electromechanical solutions that integrate its packaged piezos to solve a wide range of engineering problems.

The PPA standard product line are a range of rectangular piezoelectric packages designed for cantilever, bonded, or fixed beam configurations. Applications for these products include vibration energy harvesting, vibration dampening, precise actuation (especially useful for haptic and valve applications), vibration & strain sensing, as well as many others. Although this product line focuses on rectangular piezos, Midé can design and manufacture a wide range of shapes and sizes. Please refer to Section 7 if a custom design is required.

This datasheet provides comprehensive data for all products. Section 1 provides performance summary information for the main applications of these products and also higher volume pricing for comparison. Section 2 provides more in depth information by product. Section 3 details how electrical connection to the piezos can be achieved. Section 4 explains how these products should be mounted when in the cantilever position and includes detailed information on the PPA-9001 clamp kit. This kit is recommended for all products when they are being evaluated in the cantilever configuration. This kit includes all the necessary hardware to mount and clamp the products, tip masses to tune the beams to resonance, necessary tools for the hardware and electrical tape for insulation. Also included in this section is the recommended epoxy for direct bonding applications. Section 5 provides the material properties for modeling and simulation. Section 6 details the test procedures used to gather all data presented in this datasheet.

1.1 OVERVIEW

Figure 1: Provides an overview of these products as well as to scale drawing for size comparison.

Products	PPA-1001	PPA-1011 PPA-2011 PPA-4011	PPA-1012	PPA-1013	PPA-1014 PPA-2014	PPA-1021	PPA-1022
Length (mm) [mils]	(54.4) [2.14]	(71.0) [2.80]	(71.0) [2.80]	(71.0) [2.80]	(53.0) [2.09]	(71.0) [2.80]	(53.0) [2.09]
Width (mm) [mils]	(22.4) [0.88]	(25.4) [1.00]	(41.5) [1.63]	(41.5) [1.63]	(20.8) [0.82]	(10.3) [0.41]	(10.3) [0.41]
Thickness (mm) [mils]	(0.46) [18.0]	(0.71) [28.0] (0.76) [30.0] (1.32) [52.0]	(0.75) [29.5] (0.80) [31.5]	(1.94) [76.5]	(0.74) [29.0] (0.83) [32.5]	(0.74) [29.0] (0.86) [34.0]	(0.70) [27.4] (0.70) [27.4]
Piezo Length (mm) [mils]	(46.0) [1.81]	(46.0) [1.81]	(46.0) [1.81]	(46.0) [1.81]	(27.8) [1.09]	(46.0) [1.81]	(21.6) [0.85]
Piezo Width (mm) [mils]	(20.8) [0.82]	(20.8) [0.82]	(38.4) [1.51]	(33.4) [1.31]	(18.0) [0.71]	(06.4) [0.25]	(03.7) [0.15]
Piezo Thickness (mm) [mils]	(0.18) [06.0]	(0.18) [06.0]	(0.25) [10.0]	(1.47) [58.0]	(0.19) [07.5]	(0.25) [10.0]	(0.18) [07.0]
Number of Piezo Layers	1	1 2 4	1	1	1 2	1	1
Piezo Materials	PZT-5H	PZT-5H	PZT-5H	PZT-5H	PZT-5H	PZT-5H	PZT-5H
Capacitance (nF)	100	97 190 415	120	24	41 94	22	7
Mass (grams)	2.8	3.0 4.0 7.6	6.0	21.5	2.0 2.9	1.4	0.8

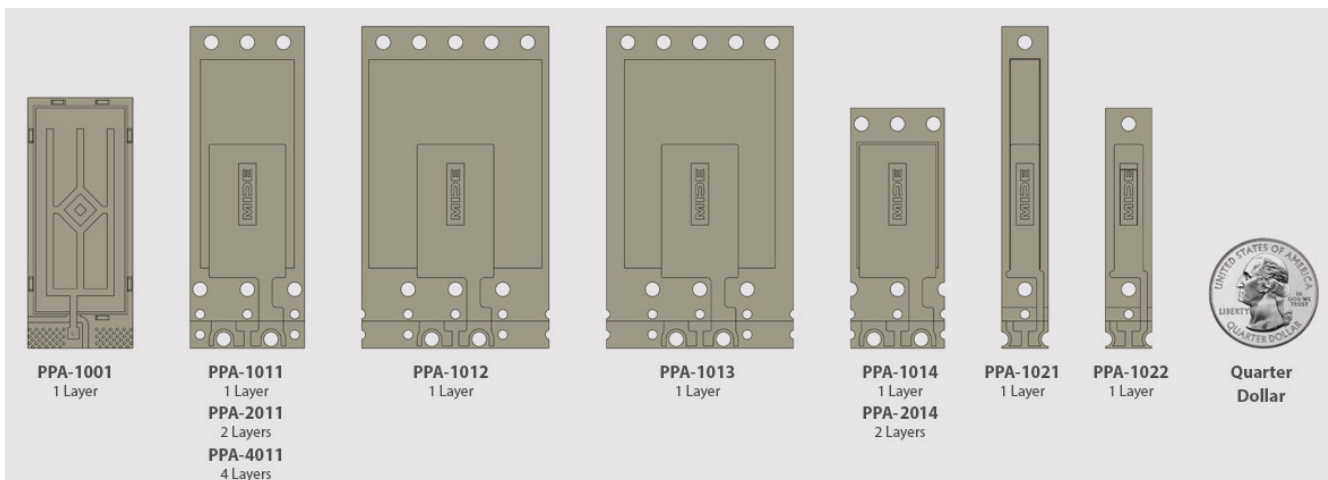

Figure 1: The PPA standard product range is shown to scale, with a United States quarter included as a reference scale.

These products come in 8 product sets, grouped by form factor. Within each set, the first numerical digit in the product part number designates the number of piezo layers. These PPA products come as unimorph (single layer), bimorph (two active piezo layers) and quad-morphs (four active layers). One product set, PPA-103X, is differentiated by piezoelectric material. PMN-PT, PZT-5H, and PZT-5A material choices are available. See Section 5.1 for more information on piezoelectric material properties.

1.2 VOLUME PRICING

Midé's PPA product line offers cost effective piezoelectric packages to customers, these costs and sale prices drop dramatically with increased volumes as shown in Table 1. These prices are subject to change at any time and are only available when buying directly through Midé. Distributors offer these products at low quantities. Midé typically keeps about 100 units of each product in stock at all times. Orders of over 100 units will have a lead time of 4 to 6 weeks. If an order of 1,000 or more units is desired, please contact Midé for a more accurate lead time estimation. For even larger volume orders, please [contact](#) midé for quotation.

Table 1: Volume Pricing of PPA Standard Product Line

Quantity	PPA-1001	PPA-1011	PPA-2011	PPA-4011	PPA-1012	PPA-1013	PPA-1014	PPA-2014	PPA-1021	PPA-1022
1	\$36.00	\$200.00	\$238.00	\$300.00	\$210.00	\$334.00	\$194.00	\$228.00	\$184.00	\$176.00
2	\$27.00	\$150.00	\$179.00	\$225.00	\$158.00	\$251.00	\$146.00	171.00	\$138.00	\$132.00
5	\$22.00	\$120.00	\$143.00	\$180.00	\$126.00	\$201.00	\$117.00	\$137.00	\$111.00	\$106.00
10	\$18.00	\$100.00	\$119.00	\$150.00	\$105.00	\$167.00	\$97.00	\$114.00	\$92.00	\$88.00
100	\$12.36	\$45.04	\$69.75	\$107.63	\$47.13	\$104.59	\$43.54	\$67.19	\$31.09	\$28.43
1,000	\$8.15	\$21.16	\$31.93	\$51.27	\$27.28	\$55.86	\$20.43	\$30.69	\$18.15	\$16.85
10,000	\$5.85	\$13.55	\$20.03	\$30.15	\$18.25	\$34.18	\$13.16	\$19.36	\$10.86	\$10.16

Note: PPA-1001 product is sold in packs of 5

1.3.1 VIBRATION ENERGY HARVESTING

Midé’s PPA standard products utilize the piezoelectric effect to convert mechanical energy in the form of vibration or shock into electrical energy. These provide optimal power output when they are properly clamped per the instructions in Section 4 and have a resonant frequency that matches the dominate frequency of the system it is harvesting energy from. All of the PPA products can be tuned to a wide range of frequencies. Adding tip mass greatly reduces the resonant frequency and further adjustment can be made by changing the clamp location. To increase the resonant frequency the piezo beams can be clamped on both ends and/or bonded to a stiffer beam.

The power output of all of the recommended energy harvesting products are compared when tuned to a 60 Hz resonance. Figure 2 shows the comparison between these products for four different acceleration amplitudes: 0.25g, 0.50g, 1.0g, and 2.0g. Figure 3 compares the power output for each product when there is no tip mass added; this represents the upper limit of the products frequency range if the clamping configuration is not changed. Figure 4 compares the power output for each product when there is the maximum tip mass added; this represents the lower limit of the products frequency range if the clamping configuration is not changed. These tests were all with beams clamped in the middle clamp location.

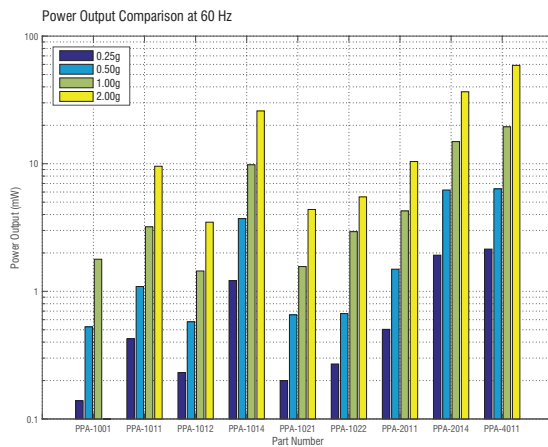

Figure 2: The power output of each product when tuned to 60 Hz is shown for four different acceleration amplitudes: 0.25g, 0.50g, 1.0g, and 2.0g. Please refer to the product’s specific section to determine how much tip mass was added to achieve a 60 Hz resonance.

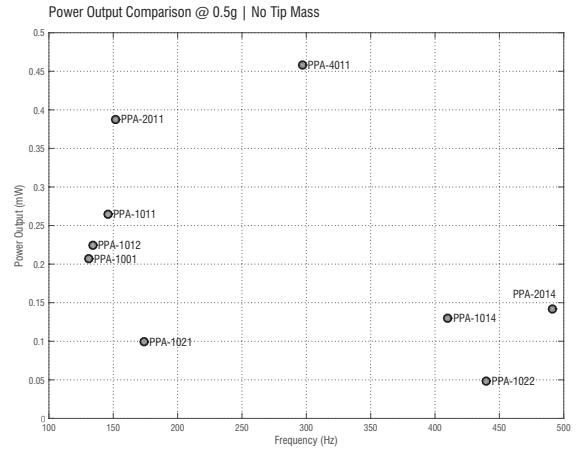

Figure 3: The power output at each product’s resonant frequency is compared. These were excited with a 0.5g amplitude sinewave at the respective resonant frequency. No tip mass was added, these frequencies represent the upper end of each products frequency range without adjusting the clamp configuration.

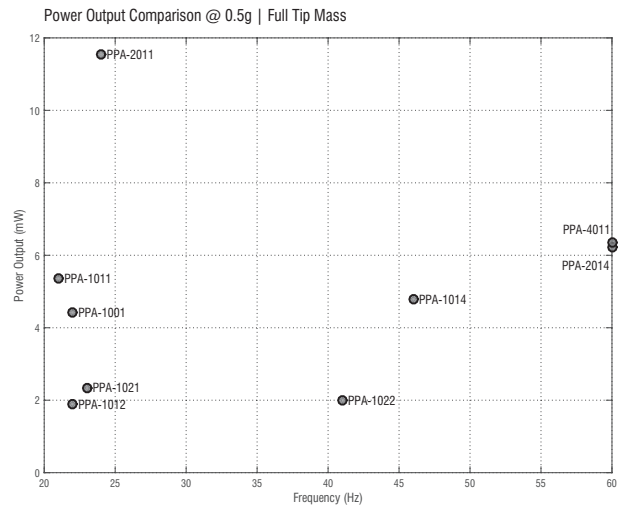

Figure 4: The power output at each product’s resonant frequency is compared when the maximum recommended tip mass is added. These were excited with a 0.5g amplitude sinewave at the respective resonant frequency. These frequencies represent the lower end of each products frequency range without adjusting the clamp configuration. Please refer to the product’s specific section for the tip mass used.

Please refer to Section 2 for product specific information at a range of frequencies, and acceleration amplitudes.

1.3.2 ACTUATION

The PPA products can also be driven as an actuator by applying an electric voltage to them. These are often used in valves where fast and controlled actuation is needed. To compare the relative performance of these range of products a plot of block force and maximum tip displacement is provided Figure 5. Adjusting the clamp location changes this displacement/force relationship; this data is listed for each product in Section 2.

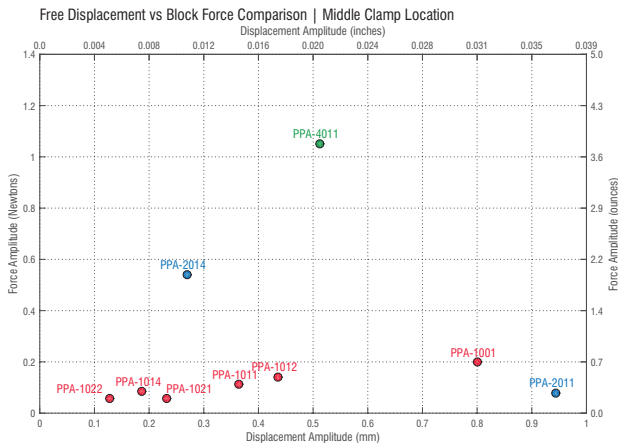

Figure 5: The block force is plotted compared to the maximum, unloaded tip displacement for static, or near static, actuation.

When driven at resonance the peak displacement will be much greater than when driven at static or quasi static speeds. Figure 6 provides a comparison between these products when driven at resonance and a 100 volt amplitude sine wave. The PPA-4011 was only driven with a 50 volt amplitude to prevent damaging the product. Figure 7 provides this frequency and tip displacement comparison when tip masses were added. These tests were all with the products clamped at the middle clamp location.

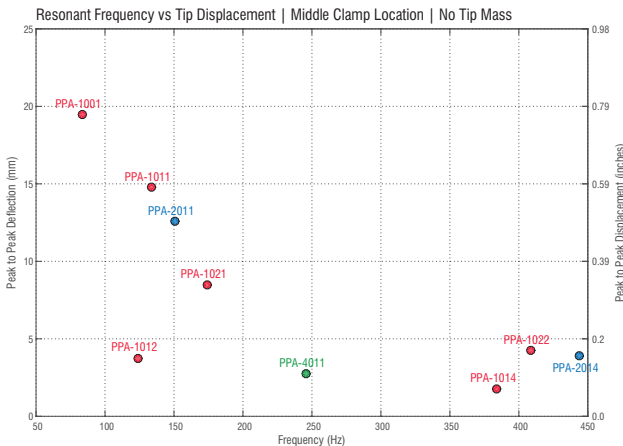

Figure 6: The peak to peak displacement when driven at resonance is shown for all products. They were driven with a 100 volt amplitude sine wave for each product except the PPA-4011 which was only driven with 50 volts.

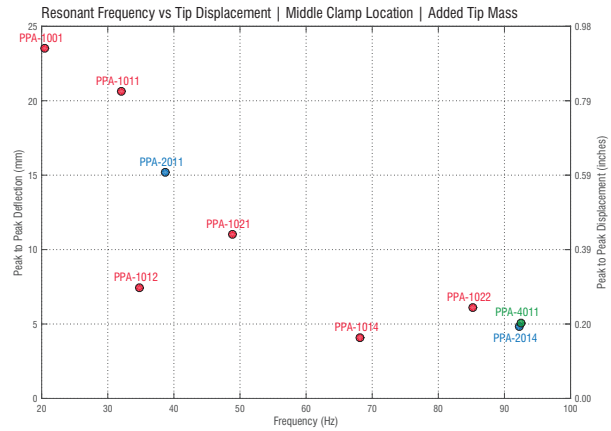

Figure 7: Adding tip mass reduces the resonant frequency and can also increase tip displacement. The PPA-1021 and PPA-1022 had a 3.1 gram tip mass; the rest, excluding PPA-1012 which had a 15.5 gram tip mass, had tip masses of 9.3 grams.

Strain actuation test data is coming soon. Please Contact Us to be placed on a mailing list to receive notification when this information is available.

1.3.3. SENSING

Piezos provide an electrical output when strained and therefore they are often used as sensors. What's unique about Midé's PPA products is that their size results in a very large output for a given mechanical input. This results in the ability to use piezos as unpowered sensors. This is very useful for applications that require a very long lifetime and/or where batteries may not be an option. Figure 8 provides a plot comparing the sensitivity of each product to the upper limit of the usable frequency range. This frequency range is defined as when the deviation is within ± 3 dB of the sensitivity. Adding tip mass will increase the sensitivity but it will also greatly reduce the bandwidth of the sensor. These tests were with the piezo clamped in the middle clamp location. The -6mm clamp location wouldn't be very useful in this application because it will reduce the bandwidth and the sensitivity because it is not clamped on the piezo. Clamping at the +6mm location will increase the bandwidth but decrease the sensitivity; this may be useful for some applications.

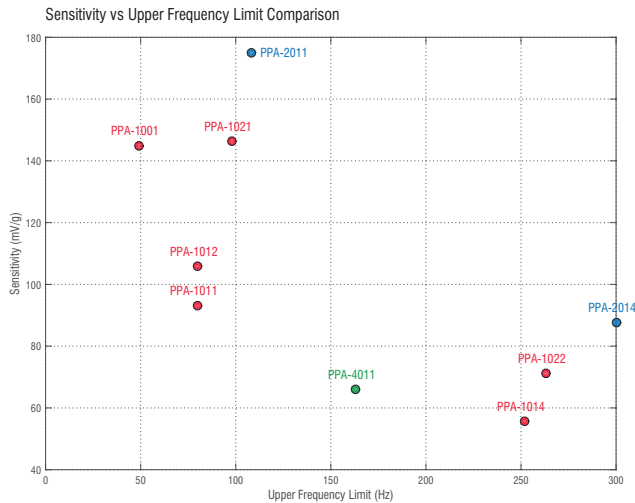

Figure 8: The sensitivity of each product is plotted against the upper limit of the usable frequency range. This frequency range is defined as when the deviation is within ± 3 dB of the sensitivity.

Strain sensing test data is coming soon. Please Contact Us to be placed on a mailing list to receive notification when this information is available.

1.3.4. VIBRATION DAMPENING

Midé’s vibration energy harvesters convert mechanical energy into electrical energy. Because of this piezoelectric effect, Midé’s piezo products are taking mechanical energy out of the system and providing electrical power to a sensing system. Thus Midé’s energy harvesters can not only harvest otherwise unused energy, it can also prolong the life of the mechanical system the energy is harvested from by dampening vibrations. If vibration dampening is all that is desired from the piezo, a shunt circuit can be utilized to dissipate the harvested mechanical energy into heat and/or a magnetic field. Thus, through the use of the piezoelectric, the mechanical energy in the system is passively dampened. Vibration dampening test data is coming soon. Please Contact Us to be placed on a mailing list to receive notification when this information is available.

2.1 PRODUCT: PPA-1001

The PPA-1001 is a single layer product recommended for energy harvesting and sensing applications. It also exhibits good performance as a resonant actuator. It is not recommended for applications requiring high force output. This product does not have mounting and alignment holes like the other products; but it is the most cost effective option Midé has.

SPECIFICATIONS

Overview		
Capacitance (nF)	100	
Mass (g)	2.8	
Full Scale Voltage Range (V)	±120	
Layer Material ¹	Thickness (mils)	Thickness (mm)
Polyester	2.0	0.05
Copper	1.4	0.03
PZT 5H	6.0	0.15
Stainless Steel 304	6.0	0.15
Polyimide	1.0	0.03
Total	18.0	0.46

¹Information on material properties is provided in Section 5.

²The layer thicknesses do not perfectly add up to the actual thickness of the product due to the epoxy layers. These epoxy layers can be ignored for finite element analysis however.

Stiffness			
Parameter	Clamp -6	Clamp 0	Clamp 6
Effective Stiffness (N/m)	N/A	452.15	275.52
Effective Mass (g) Max Peak to Peak	N/A	0.918	0.714
Deflection (mm)	N/A	24.0	20.0

See Section 4.3 for more information on how to use this data to tune your piezo.

DESCRIPTION

Performance data for the PPA-1001 is summarized in the following tables and plots. Refer to Section 6 for information on how this data was gathered. Please note that this data is to be used only as reference and that there is some variability from unit to unit. Temperature, clamp conditions, drive quality, all can contribute to additional variability. All test data was gathered at room temperature and with the PPA-9001 clamp kit hardware.

DIMENSIONS

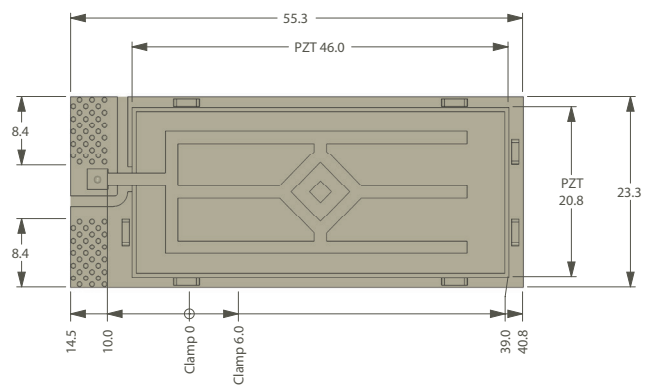

Figure 9: The overall dimensions (mm) for the PPA-1001 are shown. The total thickness is 0.46 mm (18 mils).

SPECIFICATIONS

Energy Harvesting Data for Middle Clamp Location									
Acceleration Amplitude (g)	Frequency (Hz)	Tip Mass (gram)	RMS Power (mW)	RMS Voltage (V)	RMS Current (mA)	Resistance (kΩ)	RMS Open Circuit	Peak to Peak Displacement (mm)	Peak to Peak Displacement (in)
0.25	132.0	0.0	0.1	1.1	0.1	17.9	2.1	1.1	0.04
0.50	131.0	0.0	0.2	1.9	0.1	18.3	3.6	1.4	0.05
1.00	131.0	0.0	0.7	3.4	0.2	15.7	6.0	1.6	0.06
2.00	129.0	0.0	2.2	5.4	0.4	13.0	9.9	2.2	0.09
0.25	60.0	1.9	0.1	2.9	0.0	61.0	3.8	1.2	0.05
0.50	60.0	1.8	0.5	3.3	0.2	20.8	6.7	2.1	0.08
1.00	60.0	1.7	1.8	7.1	0.3	28.6	12.2	3.9	0.15
0.25	22.0	22.8	1.4	9.0	0.1	60.4	16.4	5.2	0.21
0.50	22.0	22.8	4.4	17.3	0.3	67.6	26.6	9.3	0.37

Block Force and Static Displacement, 100 volt signal			
Parameter	Clamp -6	Clamp 0	Clamp 6
Block Force Amplitude (N)	N/A	0.20	0.23
Displacement Amplitude (mm)	N/A	0.80	0.74

Dynamic displacement, no added tip mass, +/- 100 volt signal			
Parameter	Clamp -6	Clamp 0	Clamp 6
Resonant Frequency (Hz)	N/A	83.3	98.9
Half Power Bandwidth (Hz)	N/A	5.6	7.8
Q Factor	N/A	14.9	12.7
Peak to Peak Deflection at Resonance (mm)	N/A	19.5	15.9
Quasi Static Peak to Peak Deflection (mm)	N/A	1.4	1.1

Dynamic Displacement, 9.3 tip mass, +/- 100 volt signal			
Parameter	Clamp -6	Clamp 0	Clamp 6
Resonant Frequency (Hz)	N/A	20.5	26.4
Half Power Bandwidth (Hz)	N/A	1.4	1.8
Q Factor	N/A	14.6	14.7
Peak to Peak Deflection at Resonance (mm)	N/A	23.5	19.8
Quasi Static Peak to Peak Deflection (mm)	N/A	1.8	1.8

Sensitivity, middle clamp, no added tip mass	
Sensitivity (mV/g)	145
Upper Frequency Limit (Hz)	49.0
Resonance (Hz)	135.0
Sensitivity at Resonance (V/g)	6.6

PLOTS

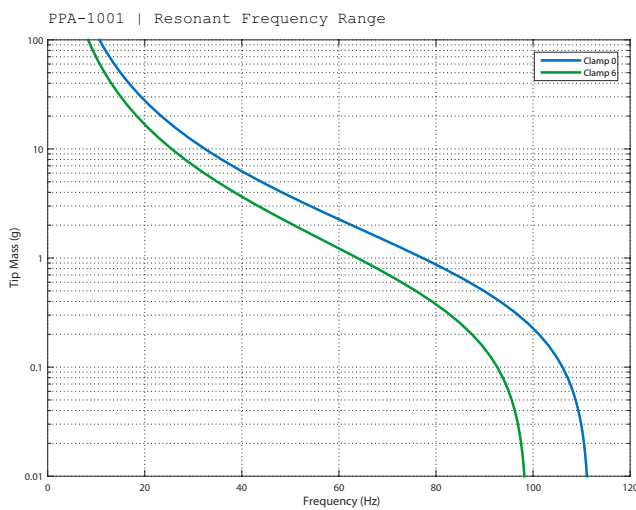

Figure 10: Refer to Section 4.3 for more information on tuning your piezo.

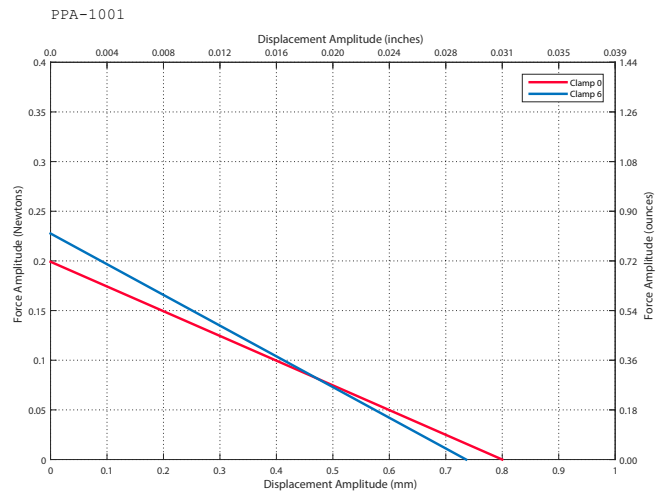

Figure 11: Static displacement and block force are compared for the three different clamp locations. The piezo was driven with 100 volts to generate this data..

PLOTS

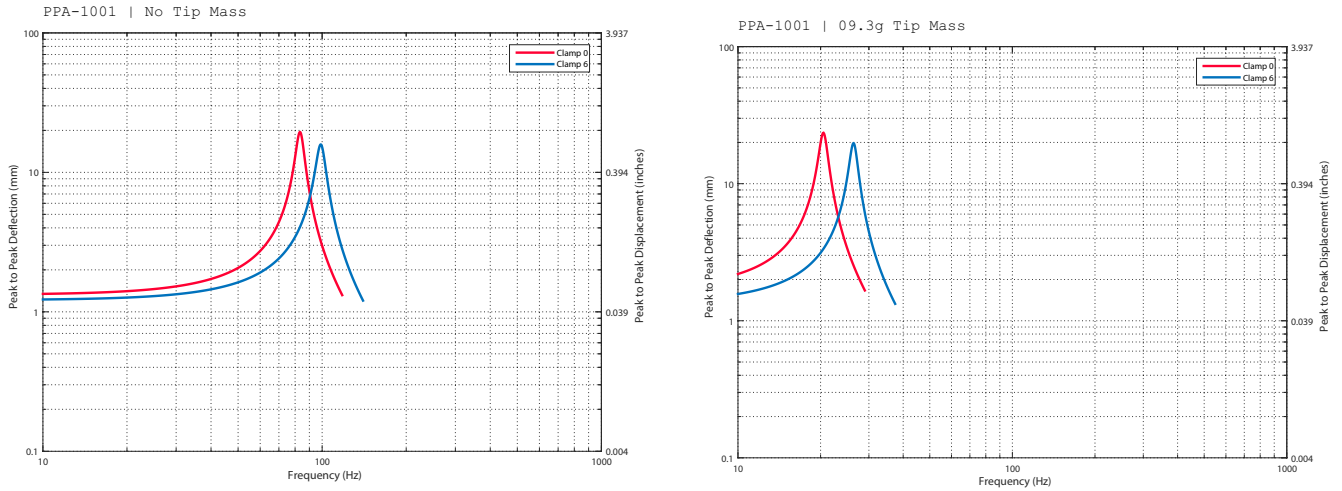

Figure 12: The peak to peak tip displacement is provided for when the piezo is driven with a ± 100 volt signal.

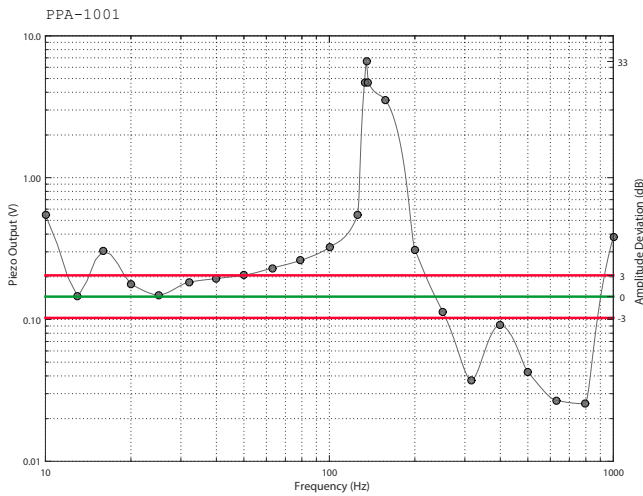

Figure 13: The frequency response of the accelerometer is provided with ± 3 dB error bands to highlight the frequency range where accurate measurement can be expected.

2.2 PRODUCT: PPA-1011

The PPA-1011 is recommended for energy harvesting and sensing applications. It also exhibits good performance as a resonant actuator.

SPECIFICATIONS

Overview	
Capacitance (nF)	100
Mass (g)	3.0
Full Scale Voltage Range (V)	± 120

Layer Material ¹	Thickness (mils)	Thickness (mm)
FR4	3.0	0.08
Copper	1.4	0.03
PZT 5H	6.0	0.15
Copper	1.4	0.03
FR4	14.0	0.36
Total²	28.0	0.71

¹Information on material properties is provided in Section 5.

²The layer thicknesses do not perfectly add up to the actual thickness of the product due to the epoxy layers. These epoxy layers can be ignored for finite element analysis however.

Stiffness			
Parameter	Clamp -6	Clamp 0	Clamp 6
Effective Stiffness (N/m)	267.45	446.28	591.81
Effective Mass (g) Max Peak to Peak	0.645	0.614	0.506
Deflection (mm)	21.0	20.5	17.0

See Section 4.3 for more information on how to use this data to tune your piezo.

OVERVIEW

Performance data for the PPA-1011 is summarized in the following tables and plots. Refer to Section 6 for information on how this data was gathered. Please note that this data is to be used only as reference and that there is some variability from unit to unit. Temperature, clamp conditions, drive quality, all can contribute to additional variability. All test data was gathered at room temperature and with the PPA-9001 clamp kit hardware.

DIMENSIONS

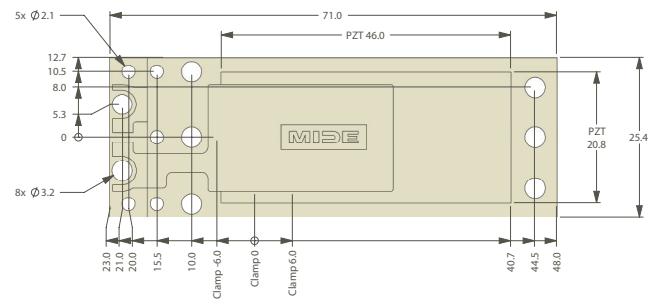

Figure 14: The overall dimensions (mm) for the PPA-1011 are shown. The total thickness is 0.71 mm (28 mils).

SPECIFICATIONS

Energy Harvesting Data for Middle Clamp Location									
Acceleration Amplitude (g)	Frequency (Hz)	Tip Mass (gram)	RMS Power (mW)	RMS Voltage (V)	RMS Current (mA)	Resistance (kΩ)	RMS Open Circuit	Peak to Peak Displacement (mm)	Peak to Peak Displacement (in)
0.25	147.0	0.0	0.1	1.1	0.1	12.1	1.7	0.9	0.04
0.50	146.0	0.0	0.3	1.8	0.1	12.6	2.8	1.4	0.06
1.00	146.0	0.0	0.7	2.7	0.3	10.2	4.3	2.2	0.09
2.00	145.0	0.0	2.1	4.6	0.5	10.1	7.3	3.7	0.15
0.25	60.0	2.7	0.4	3.3	0.1	25.0	5.7	2.7	0.11
0.50	60.0	2.6	1.1	4.2	0.3	15.8	0.6	3.5	0.14
1.00	60.0	2.6	3.2	7.9	0.4	19.5	13.8	7.0	0.28
2.00	60.0	2.6	9.6	12.8	0.7	17.3	20.7	10.1	0.40
0.25	20.8	25.3	2.5	13.8	0.2	76.6	20.2	9.7	0.38
0.50	21.0	25.3	5.4	14.9	0.4	41.2	26.9	12.9	0.51
1.00	21.0	25.3	16.0	23.2	0.7	33.7	39.7	34.1	1.34

Block Force and Static Displacement, 100 volt signal			
Parameter	Clamp -6	Clamp 0	Clamp 6
Block Force Amplitude (N)	0.09	0.11	0.11
Displacement Amplitude (mm)	0.40	0.36	0.34

Dynamic displacement, no added tip mass, +/- 100 volt signal			
Parameter	Clamp -6	Clamp 0	Clamp 6
Resonant Frequency (Hz)	102.5	133.7	172.2
Half Power Bandwidth (Hz)	5.0	7.6	10.4
Q Factor	20.5	17.6	16.6
Peak to Peak Deflection at Resonance (mm)	15.4	14.8	12.5
Quasi Static Peak to Peak Deflection (mm)	0.8	0.9	0.8

Dynamic Displacement, 9.3 tip mass, +/- 100 volt signal			
Parameter	Clamp -6	Clamp 0	Clamp 6
Resonant Frequency (Hz)	26.1	32.1	39.1
Half Power Bandwidth (Hz)	0.8	1.2	1.8
Q Factor	32.6	26.8	21.7
Peak to Peak Deflection at Resonance (mm)	20.4	20.6	16.7
Quasi Static Peak to Peak Deflection (mm)	0.8	1.0	0.8

Sensitivity, middle clamp, no added tip mass	
Sensitivity (mV/g)	93.11
Upper Frequency Limit (Hz)	80.0
Resonance (Hz)	135.0
Sensitivity at Resonance (V/g)	4.3

PLOTS

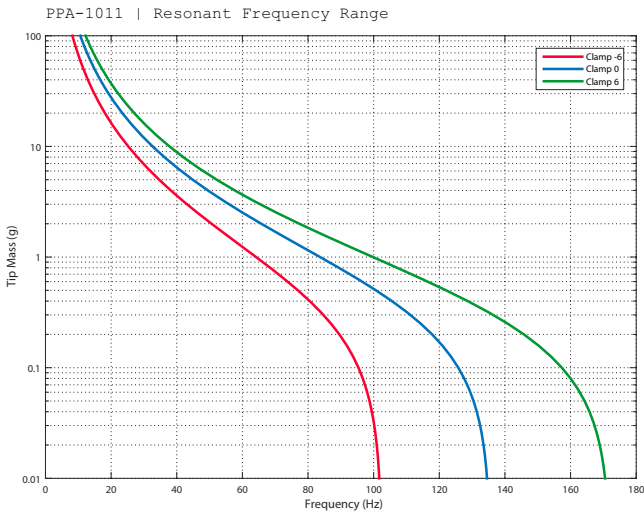

Figure 15: Refer to Section 4.3 for more information on tuning your piezo.

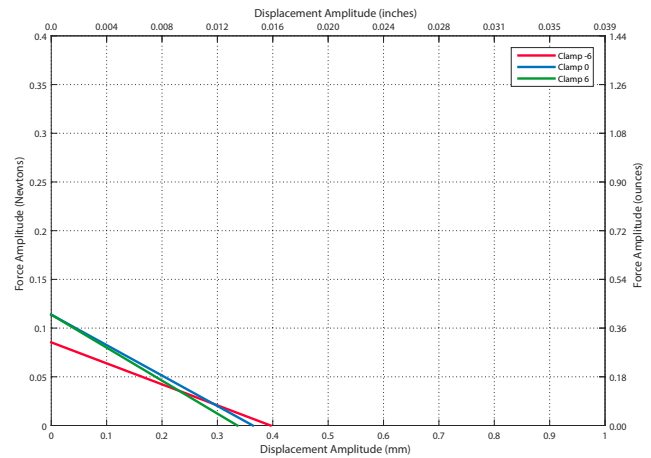

Figure 16: Static displacement and block force are compared for the three different clamp locations. The piezo was driven with 100 volts to generate this data.

PLOTS

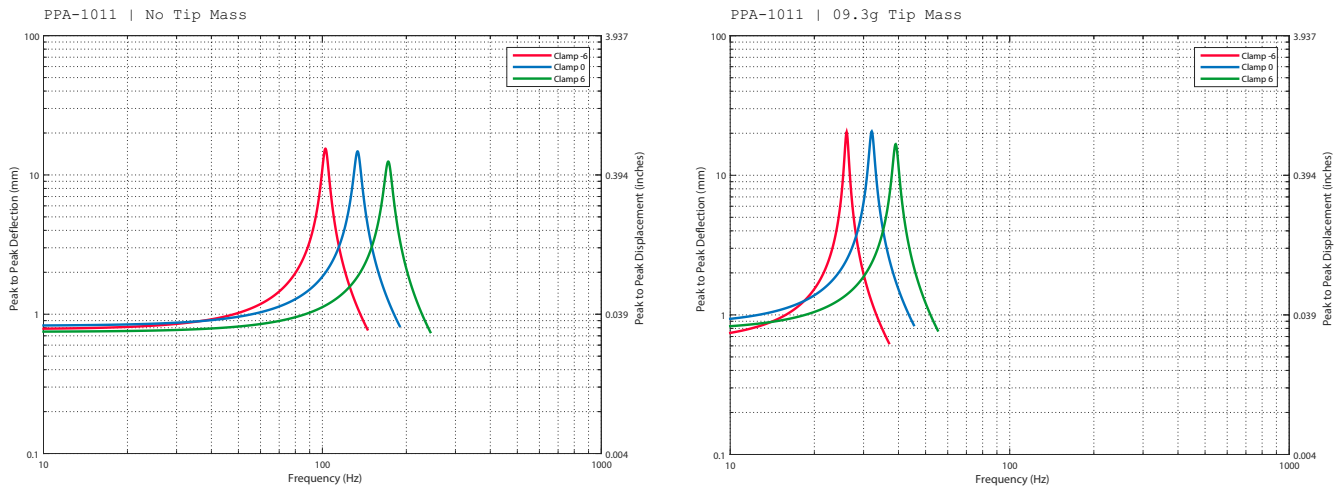

Figure 17: The peak to peak tip displacement is provided for when the piezo is driven with a ± 100 volt signal.

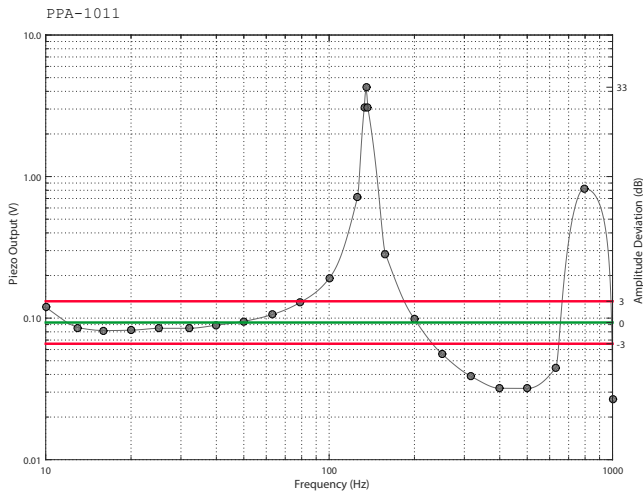

Figure 18: The frequency response of the accelerometer is provided with ± 3 dB error bands to highlight the frequency range where accurate measurement can be expected.

2.3 PRODUCT: PPA-1012

The PPA-1012 is single layer piezo product that offers decent performance as a bender. It's much wider than the other products which enable more tip mass to be added easily with is useful in some applications. This product is also recommended for bonded applications.

SPECIFICATIONS

Overview	
Capacitance (nF)	120
Mass (g)	6.0
Full Scale Voltage Range (V)	±200

Layer Material	Thickness (mils)	Thickness (mm)
FR4	3.0	0.08
Copper	1.4	0.03
PZT 5H	10.0	0.25
Copper	1.4	0.03
FR4	14.0	0.36
Total	30.0	0.76

1Information on material properties is provided in Section 5.

2The layer thicknesses do not perfectly add up to the actual thickness of the product due to the epoxy layers. These epoxy layers can be ignored for finite element analysis however.

Stiffness			
Parameter	Clamp -6	Clamp 0	Clamp 6
Effective Stiffness (N/m)	497.59	769.74	1207.05
Effective Mass (g)	1.289	1.077	1.036
Max Tip Deflection (mm)	2.0	8.0	8.0

See Section 4.3 for more information on how to use this data to tune your piezo.

DESCRIPTION

Performance data for the PPA-1012 is summarized in the following tables and plots. Refer to Section 6 for information on how this data was gathered. Please note that this data is to be used only as reference and that there is some variability from unit to unit. Temperature, clamp conditions, drive quality, all can contribute to additional variability. All test data was gathered at room temperature and with the PPA-9001 clamp kit hardware.

DIMENSIONS

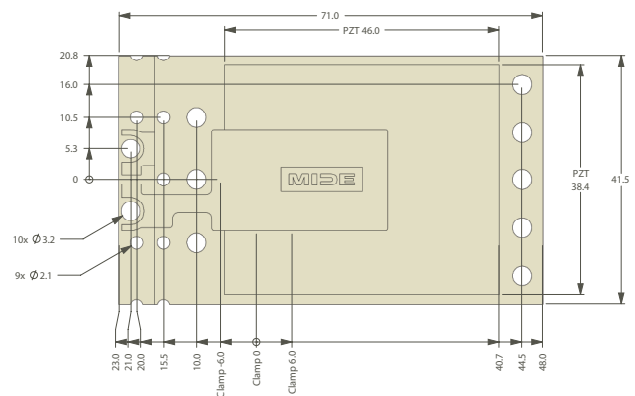

Figure 29: The overall dimensions (mm) for the PPA-1012 are shown. The total thickness is 0.76 mm (30 mils).

SPECIFICATIONS

Energy Harvesting Data for Middle Clamp Location									
Acceleration Amplitude (g)	Frequency (Hz)	Tip Mass (gram)	RMS Power (mW)	RMS Voltage (V)	RMS Current (mA)	Resistance (kΩ)	RMS Open Circuit	Peak to Peak Displacement (mm)	Peak to Peak Displacement (in)
0.25	135.0	0.0	0.1	0.7	0.1	7.2	1.3	0.7	0.03
0.50	134.0	0.0	0.2	1.3	0.2	7.6	2.1	1.2	0.05
1.00	133.0	0.0	0.6	2.1	0.3	7.2	3.4	1.9	0.08
2.00	132.0	0.0	1.5	3.7	0.4	9.1	5.3	3.2	0.12
0.25	60.0	5.4	0.2	2.0	0.1	16.8	3.3	1.6	0.06
0.50	60.0	5.4	0.6	3.5	0.2	21.5	5.1	2.6	0.10
1.00	60.0	4.9	1.4	6.3	0.2	27.4	7.9	4.1	0.16
2.00	60.0	4.4	3.5	7.7	0.5	16.8	11.6	6.7	0.25
0.25	22.0	38.0	0.4	4.1	0.1	40.3	6.5	3.6	0.13
0.50	22.0	38.0	1.9	8.7	0.2	40.5	12.7	7.8	0.29
1.00	23.0	38.0	7.1	16.2	0.4	36.7	22.7	12.6	0.46

Block Force and Static Displacement, 100 volt signal			
Parameter	Clamp -6	Clamp 0	Clamp 6
Block Force Amplitude (N)	0.11	0.14	0.17
Displacement Amplitude (mm)	0.30	0.44	0.29

Dynamic displacement, no added tip mass, +/- 100 volt signal			
Parameter	Clamp -6	Clamp 0	Clamp 6
Resonant Frequency (Hz)	98.9	124.0	171.8
Half Power Bandwidth (Hz)	6.4	10.2	13.4
Q Factor	15.5	12.2	12.8
Peak to Peak Deflection at Resonance (mm)	4.5	3.8	4.0
Quasi Static Peak to Peak Deflection (mm)	0.4	0.3	0.3

Dynamic Displacement, 9.3 tip mass, +/- 100 volt signal			
Parameter	Clamp -6	Clamp 0	Clamp 6
Resonant Frequency (Hz)	27.4	34.8	43.0
Half Power Bandwidth (Hz)	5.8	1.4	1.8
Q Factor	4.7	24.9	23.9
Peak to Peak Deflection at Resonance (mm)	1.5	7.5	7.6
Quasi Static Peak to Peak Deflection (mm)	0.3	0.4	0.5

Sensitivity, middle clamp, no added tip mass	
Sensitivity (mV/g)	106
Upper Frequency Limit (Hz)	80.0
Resonance (Hz)	133.0
Sensitivity at Resonance (V/g)	3.6

PLOTS

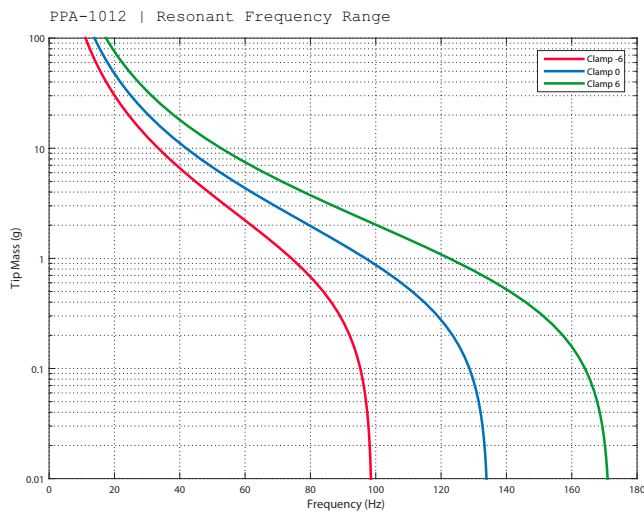

Figure 30: Refer to Section 4.3 for more information on tuning your piezo.

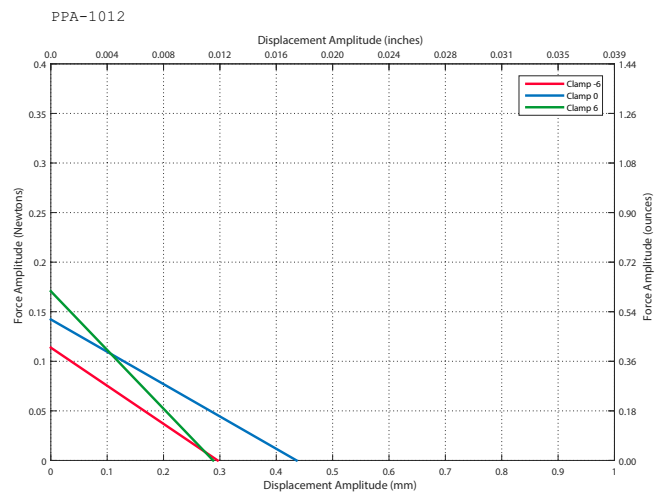

Figure 31: Static displacement and block force are compared for the three different clamp locations. The piezo was driven with 100 volts to generate this data

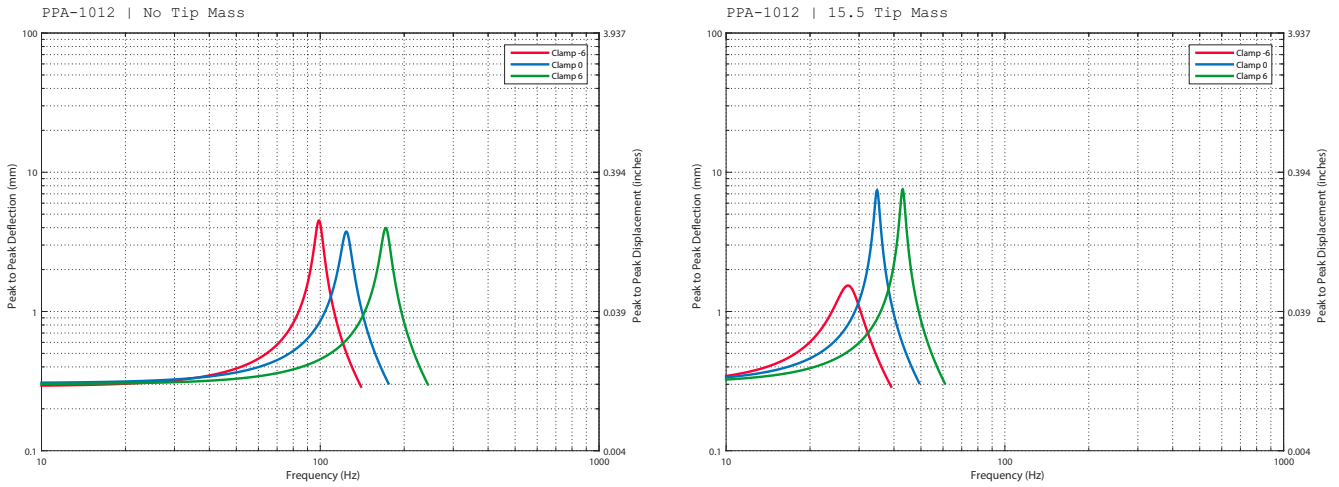

Figure 32: The peak to peak tip displacement is provided for when the piezo is driven with a ± 100 volt signal.

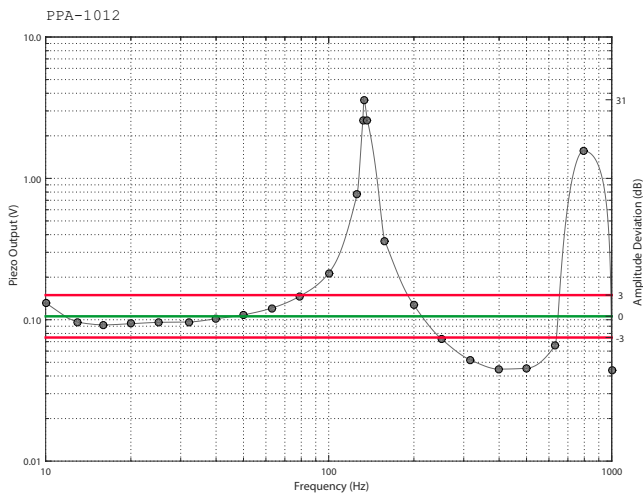

Figure 33: The frequency response of the accelerometer is provided with ± 3 dB error bands to highlight the frequency range where accurate measurement can be expected.

2.4 PRODUCT: PPA-1013

The PPA-1013 is single layer piezo product with a very thick piezo making it optimal in bonded configurations. Its thickness makes it ineffective as a bender.

SPECIFICATIONS

Overview	
Capacitance (nF)	24
Mass (g)	21.5
Full Scale Voltage Range (V)	±500

Layer Material	Thickness (mils)	Thickness (mm)
FR4	3.0	0.08
Copper	1.4	0.03
PZT 5H	58.5	1.49
Copper	1.4	0.03
FR4	14.0	0.36
Total	78.0	1.98

1 Information on material properties is provided in Section 5.

2 The layer thicknesses do not perfectly add up to the actual thickness of the product due to the epoxy layers. These epoxy layers can be ignored for finite element analysis however.

DIMENSIONS

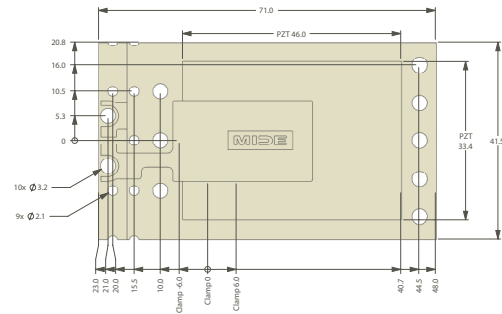

Figure 34: The overall dimensions (mm) for the PPA-1013 are shown. The total thickness is 1.98mm (78 mils).

2.5 PRODUCT: PPA-1014

The PPA-1014 is a single layer product recommended for energy harvesting and sensing applications. It also exhibits good performance as a resonant actuator. It is not recommended for applications requiring high force output. This product has a relatively high natural frequency compared to the other products which is beneficial for some applications. Due to its smaller size and good performance this is a popular product for many applications.

DESCRIPTION

Performance data for the PPA-1014 is summarized in the following tables and plots. Refer to Section 6 for information on how this data was gathered. Please note that this data is to be used only as reference and that there is some variability from unit to unit. Temperature, clamp conditions, drive quality, all can contribute to additional variability. All test data was gathered at room temperature and with the PPA-9001 clamp kit hardware.

SPECIFICATIONS

Overview	
Capacitance (nF)	40
Mass (g)	2.0
Full Scale Voltage Range (V)	±150

Layer Material	Thickness (mils)	Thickness (mm)
FR4	3.0	0.08
Copper	1.4	0.03
PZT 5H	7.5	0.19
Copper	1.4	0.03
FR4	14.0	0.36
Total	28.0	0.71

1 Information on material properties is provided in Section 5.

2 The layer thicknesses do not perfectly add up to the actual thickness of the product due to the epoxy layers. These epoxy layers can be ignored for finite element analysis however.

Stiffness			
Parameter	Clamp -6	Clamp 0	Clamp 6
Effective Stiffness (N/m)	898.54	2187.85	4167.91
Effective Mass (g)	0.336	0.339	0.240
Max Peak to Peak Deflection (mm)	6.0	5.0	5.0

See Section 4.3 for more information on how to use this data to tune your piezo.

DIMENSIONS

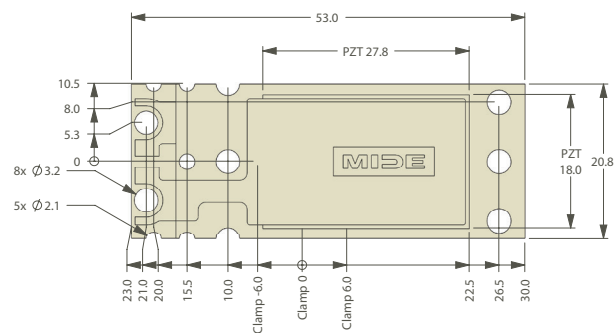

Figure 35: The overall dimensions (mm) for the PPA-1014 are shown. The total thickness is 0.71 mm (28 mils).

SPECIFICATIONS

Energy Harvesting Data for Middle Clamp Location									
Acceleration Amplitude (g)	Frequency (Hz)	Tip Mass (gram)	RMS Power (mW)	RMS Voltage (V)	RMS Current (mA)	Resistance (kΩ)	RMS Open Circuit	Peak to Peak Displacement (mm)	Peak to Peak Displacement (in)
0.25	413.0	0.0	0.0	0.6	0.1	9.0	1.2	0.3	0.01
0.50	410.0	0.0	0.1	1.3	0.1	13.6	2.2	0.5	0.02
1.00	404.0	0.0	0.4	2.0	0.2	11.1	3.3	0.7	0.03
2.00	400.0	0.0	1.1	3.2	0.4	8.9	5.7	0.8	0.03
0.25	60.0	15.1	1.2	10.8	0.1	95.7	14.4	2.4	0.09
0.50	60.0	15.1	3.7	13.9	0.3	52.1	25.8	3.3	0.13
1.00	60.0	14.9	9.8	19.5	0.5	38.8	30.5	4.0	0.15
2.00	60.0	14.9	25.9	27.3	0.9	28.8	36.1	5.0	0.19
0.25	47.0	25.3	2.0	14.1	0.1	100.0	17.0	3.1	0.12
0.50	46.0	25.3	4.8	17.2	0.3	61.9	24.8	4.6	0.18

Block Force and Static Displacement, 100 volt signal			
Parameter	Clamp -6	Clamp 0	Clamp 6
Block Force Amplitude (N)	0.09	0.09	0.23
Displacement Amplitude (mm)	0.15	0.19	0.09

Dynamic displacement, no added tip mass, +/- 100 volt signal			
Parameter	Clamp -6	Clamp 0	Clamp 6
Resonant Frequency (Hz)	260.2	384.2	663.9
Half Power Bandwidth (Hz)	9.6	72.4	54.4
Q Factor	27.1	5.3	12.2
Peak to Peak Deflection at Resonance (mm)	5.4	1.8	1.6
Quasi Static Peak to Peak Deflection (mm)	0.2	0.3	0.2

Dynamic Displacement, 9.3 tip mass, +/- 100 volt signal			
Parameter	Clamp -6	Clamp 0	Clamp 6
Resonant Frequency (Hz)	48.6	68.2	105.2
Half Power Bandwidth (Hz)	8.6	14.4	7.2
Q Factor	5.7	4.7	14.6
Peak to Peak Deflection at Resonance (mm)	6.1	4.1	9.0
Quasi Static Peak to Peak Deflection (mm)	0.9	0.8	0.5

Sensitivity, middle clamp, no added tip mass	
Sensitivity (mV/g)	56
Upper Frequency Limit (Hz)	252.0
Resonance (Hz)	417.0
Sensitivity at Resonance (V/g)	4.0

PLOTS

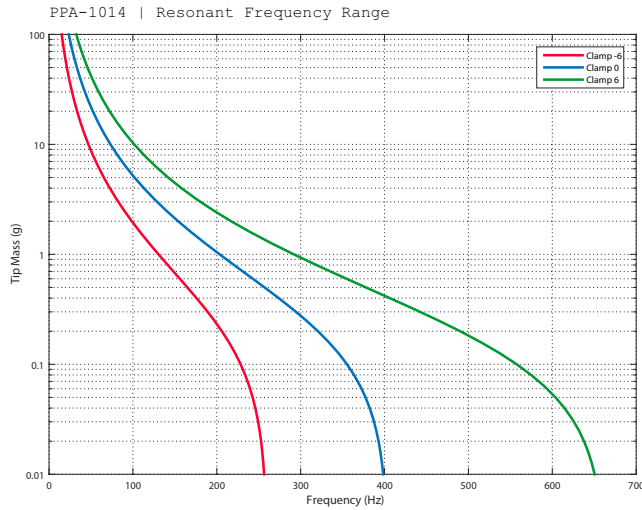

Figure 36: Refer to Section 4.3 for more information on tuning your piezo.

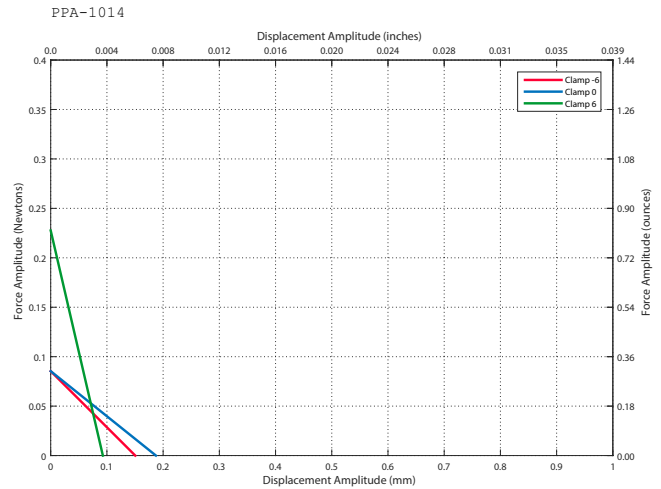

Figure 37: Static displacement and block force are compared for the three different clamp locations. The piezo was driven with 100 volts to generate this data.

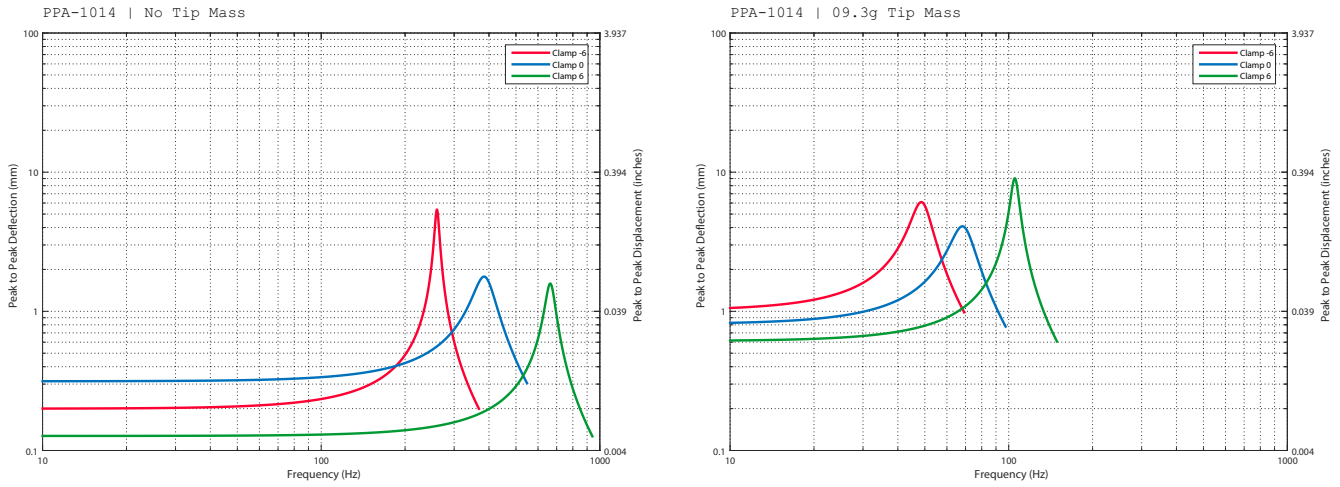

Figure 38: The peak to peak tip displacement is provided for when the piezo is driven with a ± 100 volt signal.

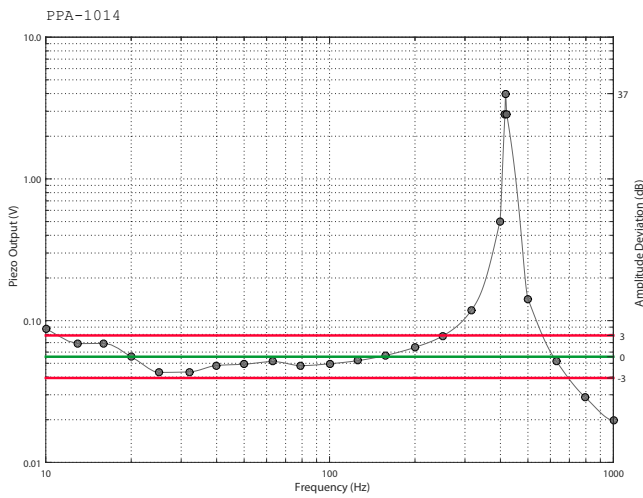

Figure 39: The frequency response of the accelerometer is provided with ± 3 dB error bands to highlight the frequency range where accurate measurement can be expected.

2.6 PRODUCT: PPA-1021

The PPA-1021 is a single layer product recommended for energy harvesting and sensing applications. It also exhibits good performance as a resonant actuator. It is not recommended for applications requiring high force output. This is a good cost effective alternative over some of the other products.

SPECIFICATIONS

Overview		
Capacitance (nF)	22	
Mass (g)	1.4	
Full Scale Voltage Range (V)	±200	
Layer Material	Thickness (mils)	Thickness (mm)
FR4	3.0	0.08
Copper	1.4	0.03
PZT 5H	10.0	0.25
Copper	1.4	0.03
FR4	14.0	0.36
Total	29.0	0.74

1Information on material properties is provided in Section 5.

2The layer thicknesses do not perfectly add up to the actual thickness of the product due to the epoxy layers. These epoxy layers can be ignored for finite element analysis however.

Stiffness			
Parameter	Clamp -6	Clamp 0	Clamp 6
Effective Stiffness (N/m)	211.60	261.21	442.60
Effective Mass (g)	0.301	0.156	0.233
Max Peak to Peak Deflection (mm)	12.0	11.0	9.0

See Section 4.3 for more information on how to use this data to tune your piezo.

DESCRIPTION

Performance data for the PPA-1021 is summarized in the following tables and plots. Refer to Section 6 for information on how this data was gathered. Please note that this data is to be used only as reference and that there is some variability from unit to unit. Temperature, clamp conditions, drive quality, all can contribute to additional variability. All test data was gathered at room temperature and with the PPA-9001 clamp kit hardware.

DIMENSIONS

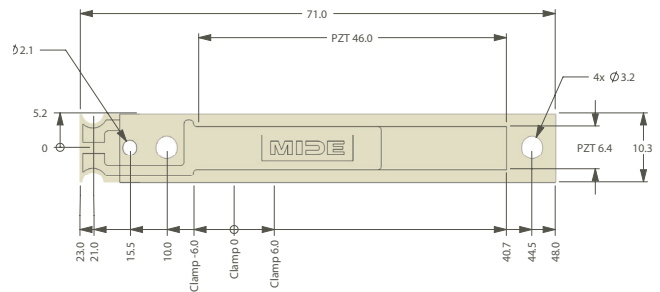

Figure 45: The overall dimensions (mm) for the PPA-1021 are shown. The total thickness is 0.74 mm (29 mils).

SPECIFICATIONS

Energy Harvesting Data for Middle Clamp Location									
Acceleration Amplitude (g)	Frequency (Hz)	Tip Mass (gram)	RMS Power (mW)	RMS Voltage (V)	RMS Current (mA)	Resistance (kΩ)	RMS Open Circuit	Peak to Peak Displacement (mm)	Peak to Peak Displacement (in)
0.25	175.0	0.0	0.0	1.2	0.0	47.3	2.1	0.6	0.02
0.50	174.0	0.0	0.1	2.3	0.0	51.9	3.5	0.9	0.04
1.00	173.0	0.0	0.3	3.6	0.1	44.5	5.9	1.5	0.06
2.00	171.0	0.0	0.9	5.6	0.2	35.1	9.8	2.5	0.10
0.25	60.0	1.8	0.2	4.1	0.0	82.5	7.2	1.5	0.06
0.50	60.0	1.7	0.7	8.6	0.1	113.9	14.3	2.9	0.11
1.00	60.0	1.7	1.6	14.0	0.1	125.1	20.5	5.4	0.21
2.00	60.0	1.7	4.4	23.2	0.2	122.9	32.2	8.9	0.34
0.25	23.0	12.7	1.3	17.8	0.1	250.6	27.3	6.5	0.25
0.50	23.0	12.7	2.3	23.3	0.1	232.5	35.5	8.8	0.33
1.00	22.0	12.7	4.5	28.2	0.2	174.9	46.8	16.1	0.59

Block Force and Static Displacement, 100 volt signal			
Parameter	Clamp -6	Clamp 0	Clamp 6
Block Force Amplitude (N)	0.06	0.06	0.09
Displacement Amplitude (mm)	0.24	0.23	0.20

Dynamic displacement, no added tip mass, +/- 100 volt signal			
Parameter	Clamp -6	Clamp 0	Clamp 6
Resonant Frequency (Hz)	133.5	174.3	219.5
Half Power Bandwidth (Hz)	4.0	6.8	19.6
Q Factor	33.4	25.6	11.2
Peak to Peak Deflection at Resonance (mm)	9.8	8.5	4.5
Quasi Static Peak to Peak Deflection (mm)	0.5	0.4	0.3

Dynamic Displacement, 9.3 tip mass, +/- 100 volt signal			
Parameter	Clamp -6	Clamp 0	Clamp 6
Resonant Frequency (Hz)	39.7	48.8	58.0
Half Power Bandwidth (Hz)	1.8	1.6	3.0
Q Factor	22.1	30.5	19.3
Peak to Peak Deflection at Resonance (mm)	11.5	11.0	8.3
Quasi Static Peak to Peak Deflection (mm)	0.5	0.4	0.5

Sensitivity, middle clamp, no added tip mass	
Sensitivity (mV/g)	146
Upper Frequency Limit (Hz)	98.0
Resonance (Hz)	182.0
Sensitivity at Resonance (V/g)	7.4

PLOTS

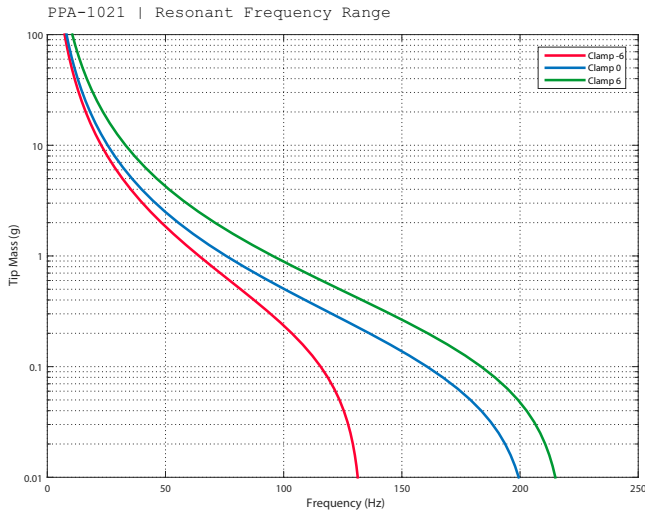

Figure 46: Refer to Section 4.3 for more information on tuning your piezo.

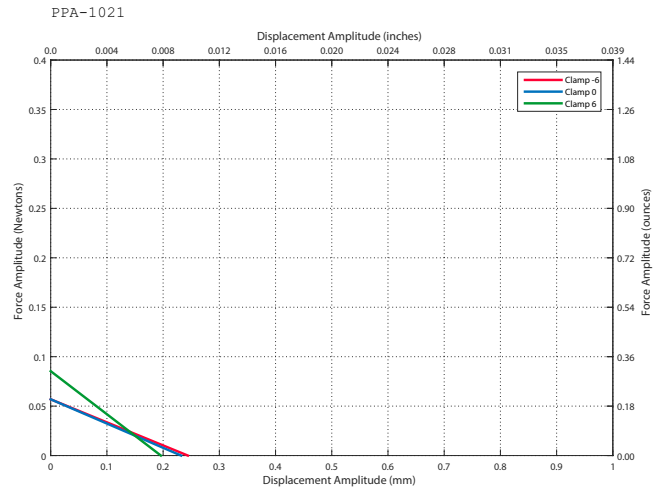

Figure 47: Static displacement and block force are compared for the three different clamp locations. The piezo was driven with 100 volts to generate this data.

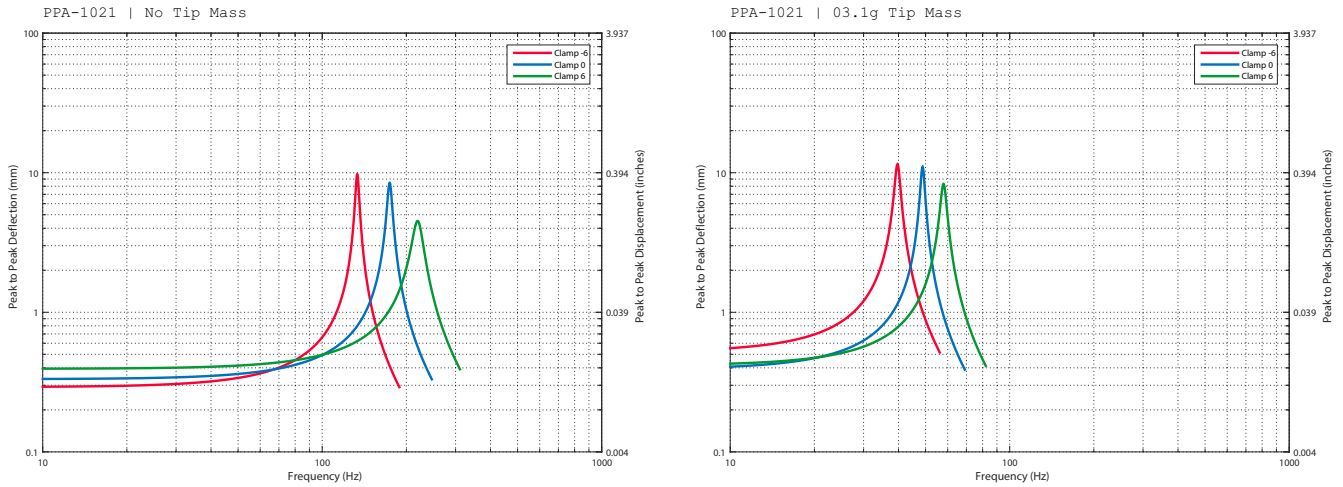

Figure 48: The peak to peak tip displacement is provided for when the piezo is driven with a ± 100 volt signal.

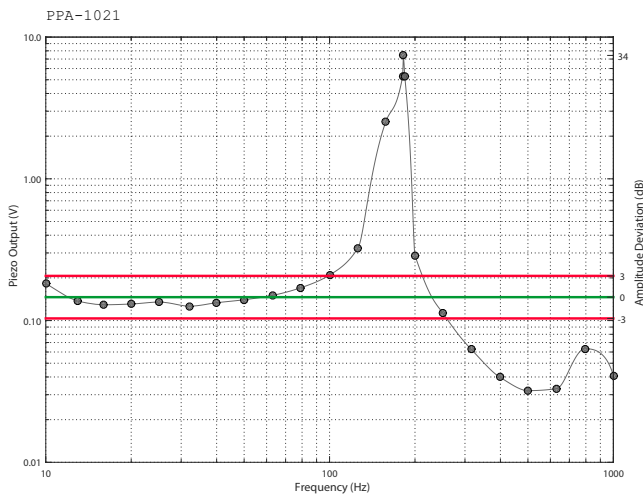

Figure 49: The frequency response of the accelerometer is provided with ± 3 dB error bands to highlight the frequency range where accurate measurement can be expected.

2.7 PRODUCT: PPA-1022

The PPA-1022 is a single layer product recommended for all applications where the most important requirement is size. Due to its smaller size it has inferior performance compared to the other products but its small size also results in lower costs.

SPECIFICATIONS

Overview	
Capacitance (nF)	7
Mass (g)	1.4
Full Scale Voltage Range (V)	±200

Layer Material	Thickness (mils)	Thickness (mm)
FR4	3.0	0.08
Copper	1.4	0.03
PZT 5H	7.0	0.18
Copper	1.4	0.03
FR4	14.0	0.36
Total	27.4	0.70

1Information on material properties is provided in Section 5.

2The layer thicknesses do not perfectly add up to the actual thickness of the product due to the epoxy layers. These epoxy layers can be ignored for finite element analysis however.

Stiffness			
Parameter	Clamp -6	Clamp 0	Clamp 6
Effective Stiffness (N/m)	517.88	853.91	1722.18
Effective Mass (g)	0.205	0.088	0.103
Max Peak to Peak Deflection (mm)	8.0	7.0	5.0

See Section 4.3 for more information on how to use this data to tune your piezo.

DESCRIPTION

Performance data for the PPA-1022 is summarized in the following tables and plots. Refer to Section 6 for information on how this data was gathered. Please note that this data is to be used only as reference and that there is some variability from unit to unit. Temperature, clamp conditions, drive quality, all can contribute to additional variability. All test data was gathered at room temperature and with the PPA-9001 clamp kit hardware.

DIMENSIONS

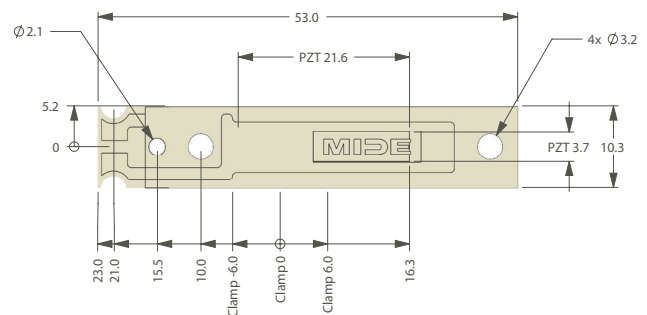

Figure 50: The overall dimensions (mm) for the PPA-1022 are shown. The total thickness is 0.74 mm (29 mils).

SPECIFICATIONS

Energy Harvesting Data for Middle Clamp Location									
Acceleration Amplitude (g)	Frequency (Hz)	Tip Mass (gram)	RMS Power (mW)	RMS Voltage (V)	RMS Current (mA)	Resistance (kΩ)	RMS Open Circuit	Peak to Peak Displacement (mm)	Peak to Peak Displacement (in)
0.25	441.0	0.0	0.0	1.1	0.0	89.9	2.0	0.1	0.005
0.50	440.0	0.0	0.0	2.0	0.0	87.1	3.4	0.2	0.009
1.00	438.0	0.0	0.2	2.6	0.1	43.1	5.6	0.4	0.015
2.00	437.0	0.0	0.5	5.1	0.1	54.3	9.3	0.6	0.023
0.25	60.0	4.8	0.3	9.0	0.0	297.7	14.5	1.6	0.062
0.50	60.0	4.8	0.7	13.9	0.0	288.2	25.3	2.9	0.112
1.00	60.0	4.8	2.9	26.2	0.1	234.0	40.4	5.0	0.192
2.00	60.0	4.8	5.5	33.0	0.2	198.0	52.3	6.7	0.254
0.25	41.5	12.6	1.1	18.1	0.1	309.2	31.7	2.6	0.100
0.50	41.0	12.6	2.0	23.7	0.1	281.7	36.9	3.2	0.118

Block Force and Static Displacement, 100 volt signal			
Parameter	Clamp -6	Clamp 0	Clamp 6
Block Force Amplitude (N)	0.03	0.06	0.09
Displacement Amplitude (mm)	0.16	0.13	0.07

Dynamic displacement, no added tip mass, +/- 100 volt signal			
Parameter	Clamp -6	Clamp 0	Clamp 6
Resonant Frequency (Hz)	252.9	408.4	650.3
Half Power Bandwidth (Hz)	10.6	10.8	15.4
Q Factor	23.9	37.8	42.2
Peak to Peak Deflection at Resonance (mm)	4.5	4.2	2.5
Quasi Static Peak to Peak Deflection (mm)	0.4	0.3	0.4

Dynamic Displacement, 9.3 tip mass, +/- 100 volt signal			
Parameter	Clamp -6	Clamp 0	Clamp 6
Resonant Frequency (Hz)	63.0	85.2	116.7
Half Power Bandwidth (Hz)	0.8	1.4	2.0
Q Factor	78.8	60.9	58.4
Peak to Peak Deflection at Resonance (mm)	7.6	6.1	4.1
Quasi Static Peak to Peak Deflection (mm)	0.2	0.3	0.2

Sensitivity, middle clamp, no added tip mass	
Sensitivity (mV/g)	71
Upper Frequency Limit (Hz)	263.0
Resonance (Hz)	457.0
Sensitivity at Resonance (V/g)	6.5

PLOTS

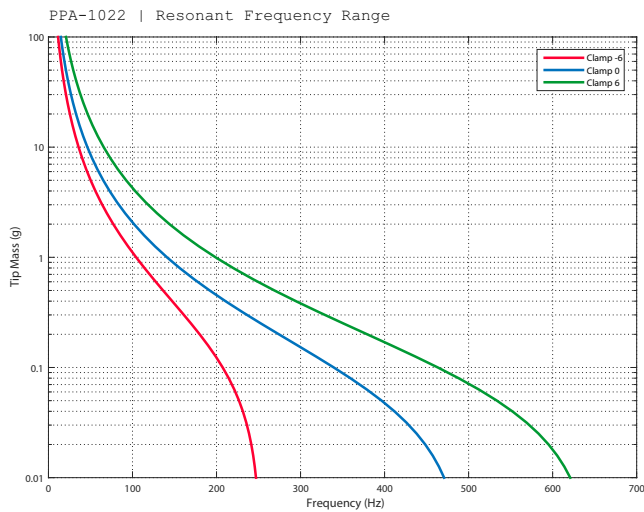

Figure 51: Refer to Section 4.3 for more information on tuning your piezo.

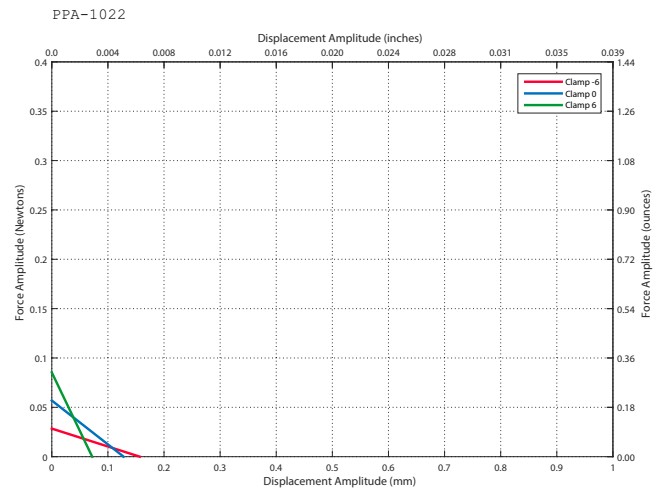

Figure 52: Static displacement and block force are compared for the three different clamp locations. The piezo was driven with 100 volts to generate this data.

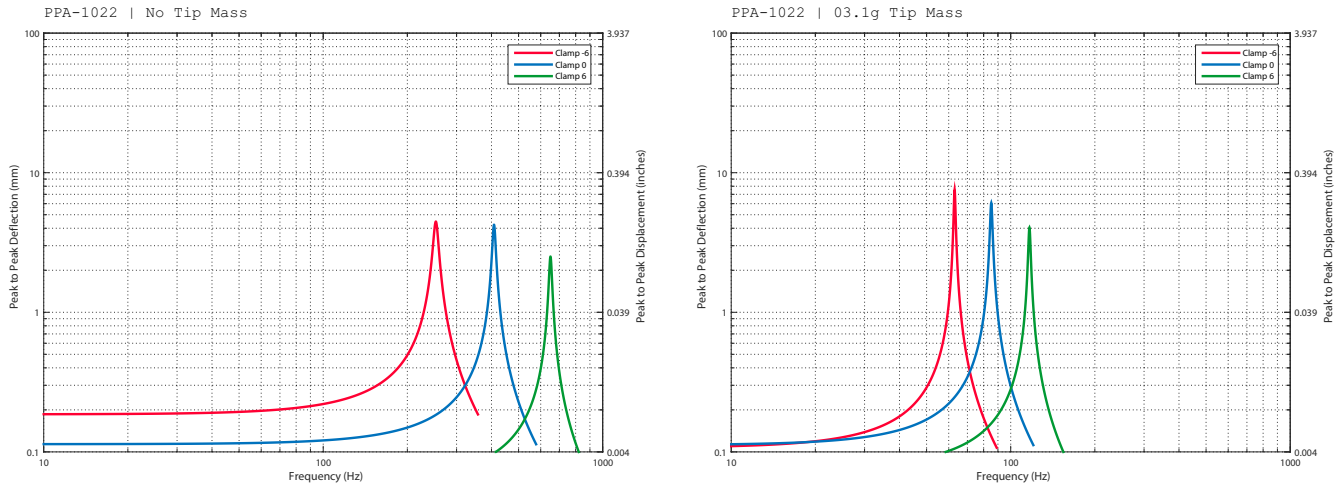

Figure 53: The peak to peak tip displacement is provided for when the piezo is driven with a ± 100 volt signal.

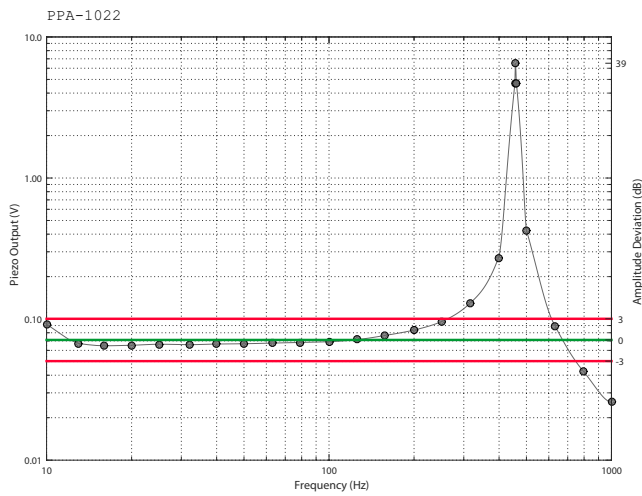

Figure 54: The frequency response of the accelerometer is provided with ± 3 dB error bands to highlight the frequency range where accurate measurement can be expected.

2.8 PRODUCT: PPA-2011

The PPA-2011 is recommended for energy harvesting and sensing applications. It also exhibits good performance as a resonant actuator. With two piezo layers it generally offers improved performance over the PPA-1011 but at a slightly higher cost.

SPECIFICATIONS

Overview	
Capacitance (nF)	190
Mass (g)	4.0
Full Scale Voltage Range (V)	±120

Layer Material ¹	Thickness (mils)	Thickness (mm)
FR4	3.0	0.08
Copper	1.4	0.03
PZT 5H	6.0	0.15
Copper	1.4	0.03
FR4	3.0	0.08
Copper	1.4	0.03
PZT 5H	6.0	0.15
Copper	1.4	0.03
FR4	3.0	0.08
Total	30.0	0.76

¹Information on material properties is provided in Section 5.

²The layer thicknesses do not perfectly add up to the actual thickness of the product due to the epoxy layers. These epoxy layers can be ignored for finite element analysis however.

Stiffness			
Parameter	Clamp -6	Clamp 0	Clamp 6
Effective Stiffness (N/m)	386.08	573.67	861.10
Effective Mass (g)	0.811	0.607	0.495
Max Tip Deflection (mm)	16.0	15.5	13.0

See Section 4.3 for more information on how to use this data to tune your piezo.

DESCRIPTION

Performance data for the PPA-2011 is summarized in the following tables and plots. Refer to Section 6 for information on how this data was gathered. Please note that this data is to be used only as reference and that there is some variability from unit to unit. Temperature, clamp conditions, drive quality, all can contribute to additional variability. All test data was gathered at room temperature and with the PPA-9001 clamp kit hardware.

DIMENSIONS

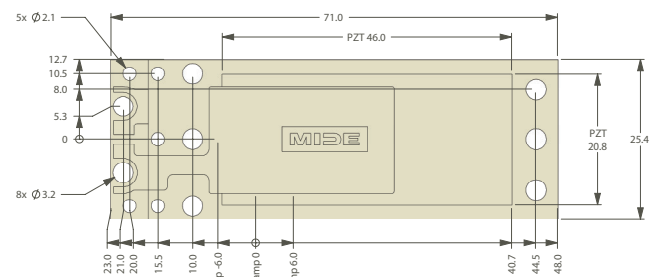

Figure 19: The overall dimensions (mm) for the PPA-2011 are shown. The total thickness is 0.76 mm (30 mils).

SPECIFICATIONS

Energy Harvesting Data for Middle Clamp Location									
Acceleration Amplitude (g)	Frequency (Hz)	Tip Mass (gram)	RMS Power (mW)	RMS Voltage (V)	RMS Current (mA)	Resistance (kΩ)	RMS Open Circuit	Peak to Peak Displacement (mm)	Peak to Peak Displacement (in)
0.25	154.0	0.0	0.1	0.9	0.1	7.0	2.3	0.6	0.03
0.50	152.0	0.0	0.4	1.2	0.3	4.0	3.7	1.0	0.04
1.00	149.0	0.0	1.2	2.0	0.6	3.3	6.0	1.6	0.06
2.00	147.0	0.0	4.0	4.5	0.9	5.1	9.2	2.6	0.10
0.25	60.0	3.5	0.5	2.3	0.2	10.5	6.3	1.6	0.06
0.50	60.0	3.4	1.5	3.7	0.4	9.0	9.1	2.3	0.09
1.00	60.0	3.3	4.3	7.9	0.5	14.7	14.8	4.3	0.17
2.00	60.0	3.4	10.4	13.7	0.8	18.2	23.3	6.9	0.27
0.25	24.0	25.3	4.1	9.9	0.4	24.0	23.3	4.8	0.19
0.50	24.0	25.3	11.5	21.3	0.5	39.4	35.9	7.9	0.31
1.00	23.8	25.3	31.0	31.0	1.0	30.9	49.6	12.0	0.47
2.00	23.0	25.3	34.0	34.0	2.0	17.2	61.5	18.5	0.73

Block Force and Static Displacement, 100 volt signal			
Parameter	Clamp -6	Clamp 0	Clamp 6
Block Force Amplitude (N)	0.06	0.80	0.12
Displacement Amplitude (mm)	0.94	0.94	0.83

Dynamic displacement, no added tip mass, +/- 100 volt signal			
Parameter	Clamp -6	Clamp 0	Clamp 6
Resonant Frequency (Hz)	109.8	150.7	210.5
Half Power Bandwidth (Hz)	7.4	10.0	15.2
Q Factor	14.8	15.1	13.8
Peak to Peak Deflection at Resonance (mm)	12.5	12.6	9.6
Quasi Static Peak to Peak Deflection (mm)	0.8	0.8	0.6

Dynamic Displacement, 9.3 tip mass, +/- 100 volt signal			
Parameter	Clamp -6	Clamp 0	Clamp 6
Resonant Frequency (Hz)	31.1	38.7	47.3
Half Power Bandwidth (Hz)	2.0	2.2	2.6
Q Factor	15.6	17.6	18.2
Peak to Peak Deflection at Resonance (mm)	15.9	15.2	12.6
Quasi Static Peak to Peak Deflection (mm)	1.0	0.9	0.6

Sensitivity, middle clamp, no added tip mass	
Sensitivity (mV/g)	175.13
Upper Frequency Limit (Hz)	108.0
Resonance (Hz)	178.0
Sensitivity at Resonance (V/g)	7.0

PLOTS

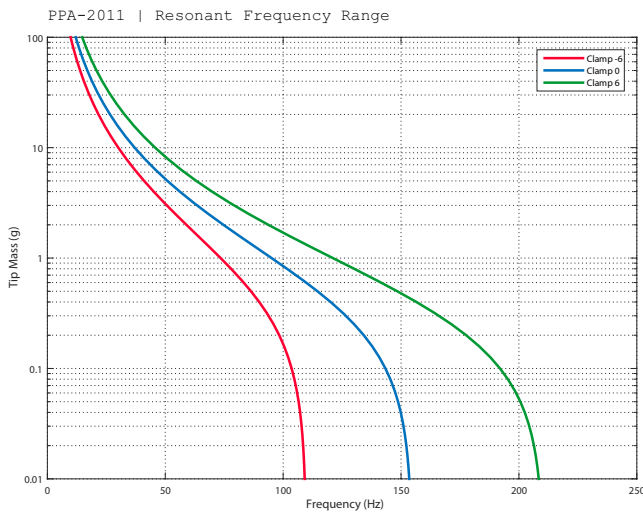

Figure 20: Refer to Section 4.3 for more information on tuning your piezo.

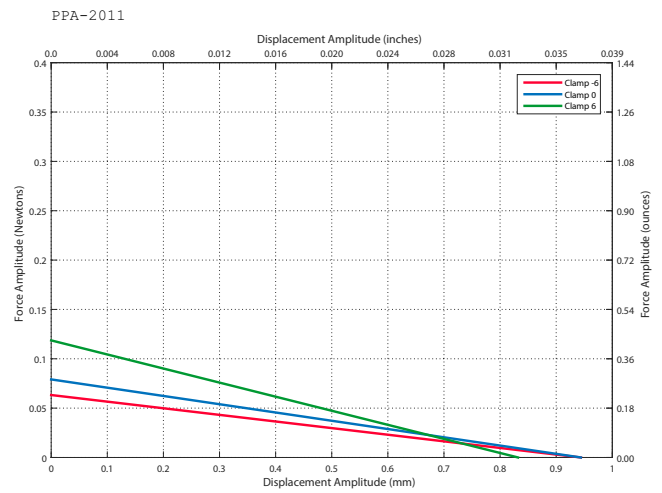

Figure 21: Static displacement and block force are compared for the three different clamp locations. The piezo was driven with 100 volts to generate this data.

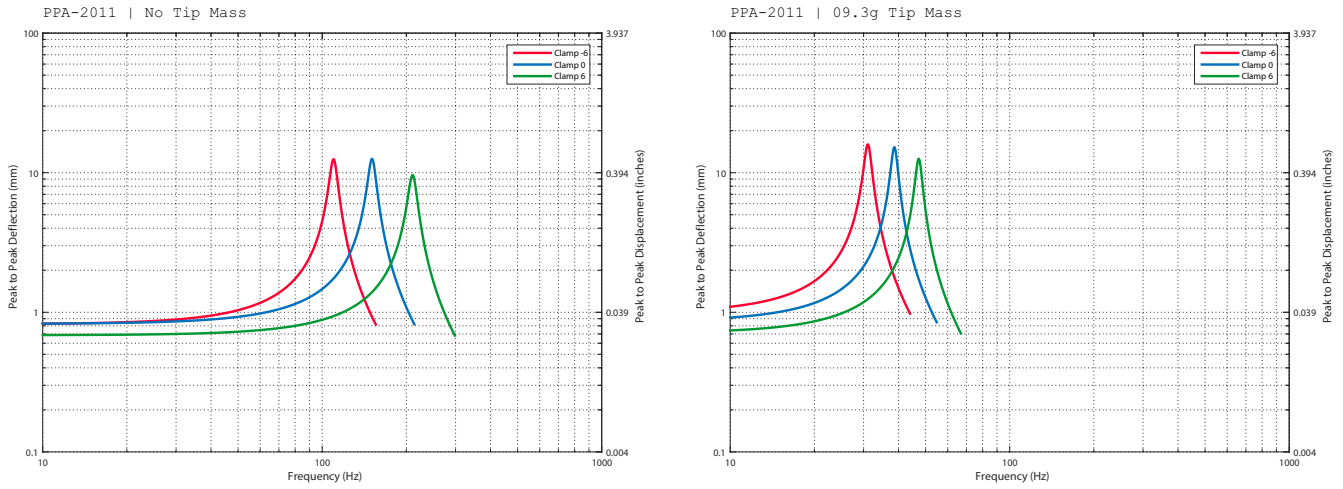

Figure 22: The peak to peak tip displacement is provided for when the piezo is driven with a ± 100 volt signal.

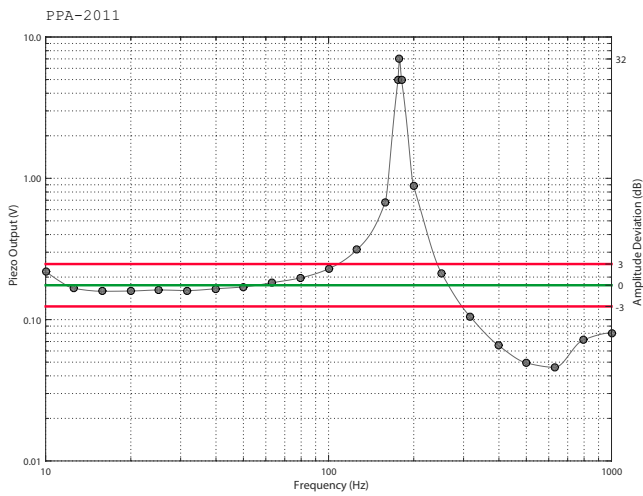

Figure 23: The frequency response of the accelerometer is provided with ± 3 dB error bands to highlight the frequency range where accurate measurement can be expected.

2.9 PRODUCT: PPA-2014

The PPA-2014 is a double layer product recommended for all applications including energy harvesting, sensing applications, resonant actuation and force/deflection actuation. This product has a relatively high natural frequency compared to the other products which is beneficial for some applications. With two piezo layers it generally offers improved performance over the PPA-2014 but at a slightly higher cost. Due to its smaller size and good performance this is a popular product for many applications.

SPECIFICATIONS

Overview	
Capacitance (nF)	95
Mass (g)	2.9
Full Scale Voltage Range (V)	± 150

Layer Material	Thickness (mils)	Thickness (mm)
FR4	3.0	0.08
Copper	1.4	0.03
PZT 5H	7.5	0.19
Copper	1.4	0.03
FR4	3.0	0.08
Copper	1.4	0.03
PZT 5H	7.5	0.19
Copper	1.4	0.03
FR4	3.0	0.08
Total	32.5	0.83

1 Information on material properties is provided in Section 5.

2 The layer thicknesses do not perfectly add up to the actual thickness of the product due to the epoxy layers. These epoxy layers can be ignored for finite element analysis however.

Stiffness			
Parameter	Clamp -6	Clamp 0	Clamp 6
Effective Stiffness (N/m)	1187.09	3882.41	6230.78
Effective Mass (g)	0.427	0.588	0.318
Max Peak to Peak Deflection (mm)	7.0	5.0	3.0

See Section 4.3 for more information on how to use this data to tune your piezo.

DESCRIPTION

Performance data for the PPA-2014 is summarized in the following tables and plots. Refer to Section 6 for information on how this data was gathered. Please note that this data is to be used only as reference and that there is some variability from unit to unit. Temperature, clamp conditions, drive quality, all can contribute to additional variability. All test data was gathered at room temperature and with the PPA-9001 clamp kit hardware.

DIMENSIONS

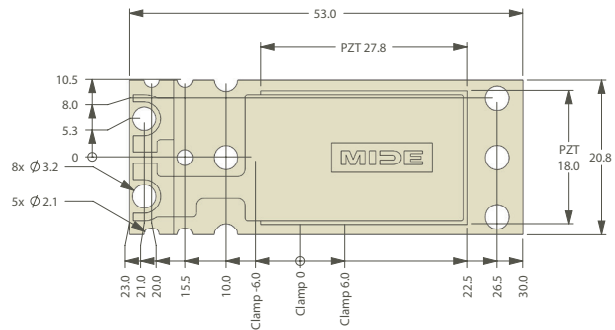

Figure 40: The overall dimensions (mm) for the PPA-2014 are shown. The total thickness is 0.83 mm (32.5 mils).

SPECIFICATIONS

Energy Harvesting Data for Middle Clamp Location									
Acceleration Amplitude (g)	Frequency (Hz)	Tip Mass (gram)	RMS Power (mW)	RMS Voltage (V)	RMS Current (mA)	Resistance (kΩ)	RMS Open Circuit	Peak to Peak Displacement (mm)	Peak to Peak Displacement (in)
0.25	493.0	0.0	0.0	0.7	0.1	10.5	1.4	0.1	0.004
0.50	491.0	0.0	0.1	1.2	0.1	9.5	2.4	0.2	0.006
1.00	488.0	0.0	0.5	1.8	0.3	6.9	3.7	0.2	0.008
2.00	483.0	0.0	1.4	2.5	0.6	4.3	5.8	0.3	0.014
0.25	63.0	25.3	1.8	9.7	0.2	51.3	17.6	0.8	0.032
0.50	62.0	25.3	5.9	15.5	0.4	41.0	28.6	1.4	0.051
1.00	62.0	25.3	15.2	23.5	0.6	36.4	36.7	1.9	0.069
2.00	64.0	25.3	36.1	27.6	1.3	21.1	41.0	2.4	0.083
0.25	60.0	26.0	1.9	7.4	0.3	28.5	19.1	0.9	0.034
0.50	60.0	25.6	6.2	16.8	0.4	45.2	30.8	1.3	0.048
1.00	60.0	25.9	14.9	24.2	0.6	39.4	39.7	1.8	0.066
2.00	60.0	26.5	36.6	29.7	1.2	24.1	43.1	2.3	0.081

Block Force and Static Displacement, 100 volt signal			
Parameter	Clamp -6	Clamp 0	Clamp 6
Block Force Amplitude (N)	0.28	0.54	0.57
Displacement Amplitude (mm)	0.30	0.27	0.22

Dynamic displacement, no added tip mass, +/- 100 volt signal			
Parameter	Clamp -6	Clamp 0	Clamp 6
Resonant Frequency (Hz)	265.4	443.9	704.5
Half Power Bandwidth (Hz)	19.2	46.2	117.4
Q Factor	13.8	9.6	6.0
Peak to Peak Deflection at Resonance (mm)	5.5	3.9	1.7
Quasi Static Peak to Peak Deflection (mm)	0.4	0.3	0.3

Dynamic Displacement, 9.3 tip mass, +/- 100 volt signal			
Parameter	Clamp -6	Clamp 0	Clamp 6
Resonant Frequency (Hz)	55.6	92.2	128.1
Half Power Bandwidth (Hz)	5.4	10.4	19.0
Q Factor	10.3	8.9	6.7
Peak to Peak Deflection at Resonance (mm)	6.8	4.8	2.9
Quasi Static Peak to Peak Deflection (mm)	0.6	0.5	0.4

Sensitivity, middle clamp, no added tip mass	
Sensitivity (mV/g)	88
Upper Frequency Limit (Hz)	300.0
Resonance (Hz)	506.0
Sensitivity at Resonance (V/g)	4.5

PLOTS

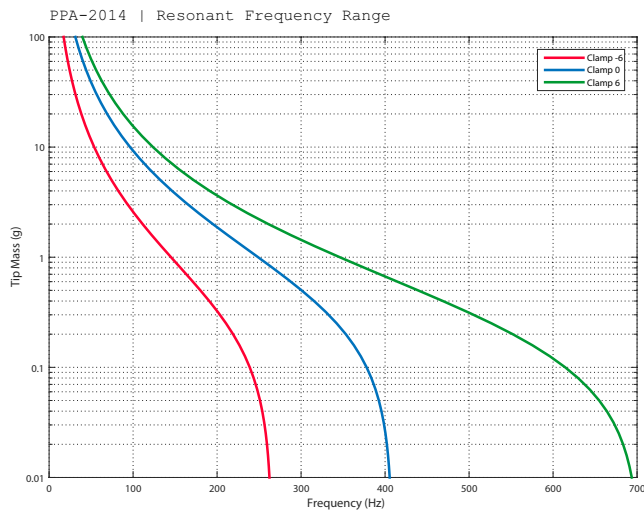

Figure 41: Refer to Section 4.3 for more information on tuning your piezo.

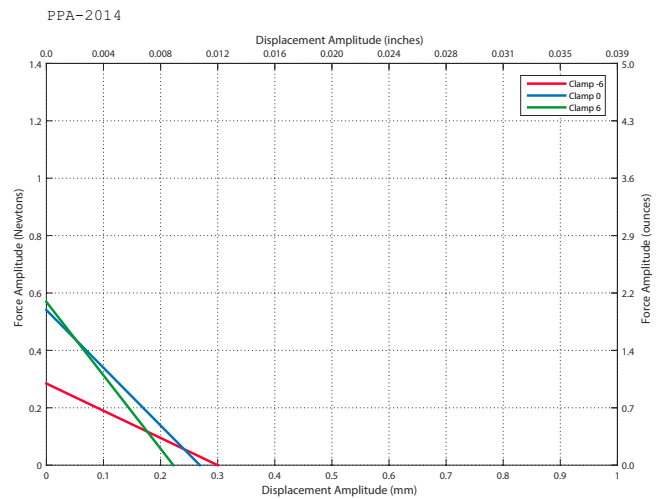

Figure 42: Static displacement and block force are compared for the three different clamp locations. The piezo was driven with 100 volts to generate this data.

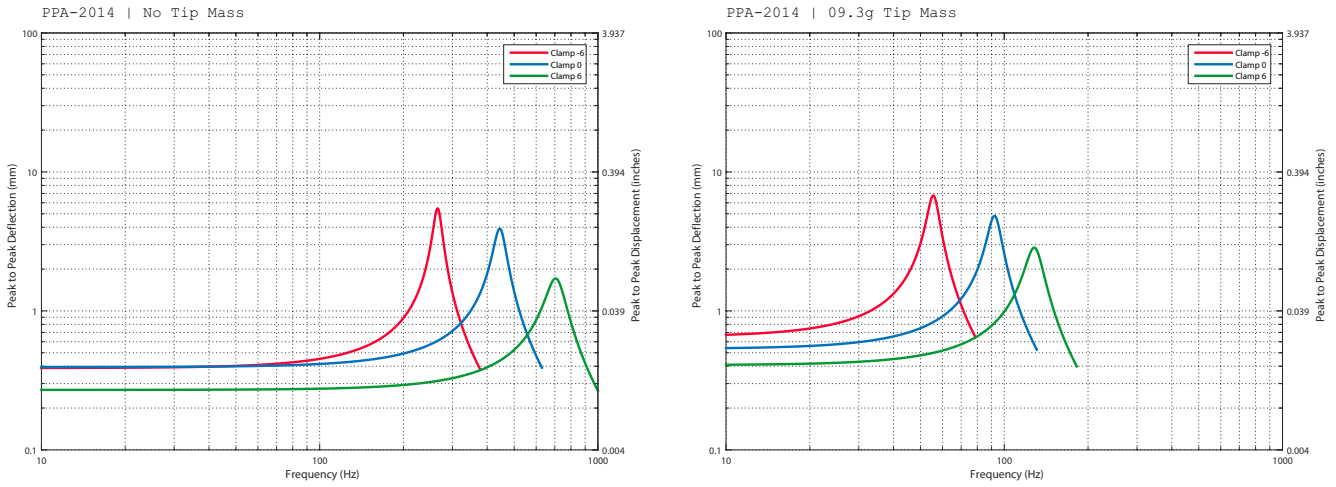

Figure 43: The peak to peak tip displacement is provided for when the piezo is driven with a ± 100 volt signal.

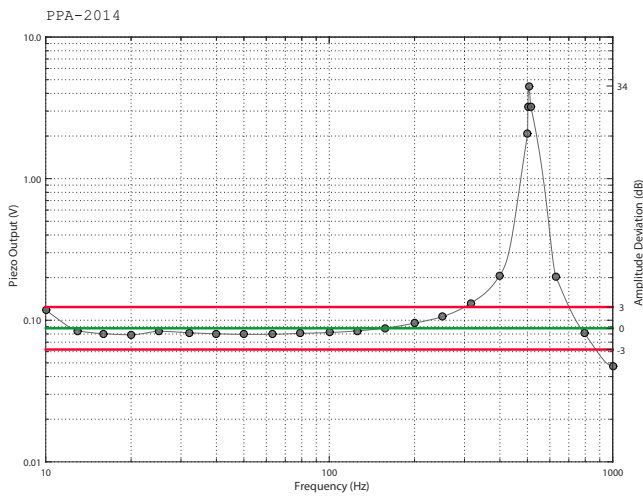

Figure 44: The frequency response of the accelerometer is provided with ± 3 dB error bands to highlight the frequency range where accurate measurement can be expected.

2.10 PRODUCT: PPA-4011

The PPA-4011 is recommended for all applications due its superior performance. This product incorporates four piezo wafers which drives up the cost on the unit compared to other options; but this also results in significant performance improvements.

SPECIFICATIONS

Overview	
Capacitance (nF)	415
Mass (g)	7.6
Full Scale Voltage Range (V)	±120

Layer Material	Thickness (mils)	Thickness (mm)
FR4	3.0	0.08
Copper	1.4	0.03
PZT 5H	6.0	0.15
Copper	1.4	0.03
FR4	3.0	0.08
Copper	1.4	0.03
PZT 5H	6.0	0.15
Copper	1.4	0.03
FR4	3.0	0.08
Copper	1.4	0.03
FR4	6.0	0.15
Copper	1.4	0.03
PZT 5H	3.0	0.08
Copper	1.4	0.03
PZT 5H	6.0	0.15
Copper	1.4	0.03
FR4	30	0.08
Total	52.0	1.32

¹Information on material properties is provided in Section 5.

²The layer thicknesses do not perfectly add up to the actual thickness of the product due to the epoxy layers. These epoxy layers can be ignored for finite element analysis however.

DESCRIPTION

Performance data for the PPA-4011 is summarized in the following tables and plots. Refer to Section 6 for information on how this data was gathered. Please note that this data is to be used only as reference and that there is some variability from unit to unit. Temperature, clamp conditions, drive quality, all can contribute to additional variability. All test data was gathered at room temperature and with the PPA-9001 clamp kit hardware.

DIMENSIONS

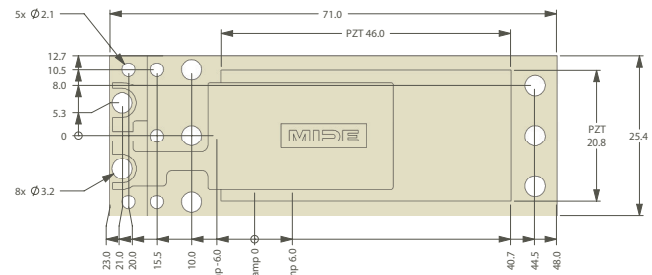

Figure 24: The overall dimensions (mm) for the PPA-4011 are shown. The total thickness is 1.3 mm (52 mils).

Stiffness			
Parameter	Clamp -6	Clamp 0	Clamp 6
Effective Stiffness (N/m)	1934.93	4125.55	5534.45
Effective Mass (g)	1.457	1.480	1.936
Max Tip Deflection (mm)	7.0	5.0	4.5

See Section 4.3 for more information on how to use this data to tune your piezo.

SPECIFICATIONS

Energy Harvesting Data for Middle Clamp Location									
Acceleration Amplitude (g)	Frequency (Hz)	Tip Mass (gram)	RMS Power (mW)	RMS Voltage (V)	RMS Current (mA)	Resistance (kΩ)	RMS Open Circuit	Peak to Peak Displacement (mm)	Peak to Peak Displacement (in)
0.25	298.0	0.0	0.1	0.5	0.3	1.9	1.1	0.2	0.01
0.50	297.0	0.0	0.5	0.8	0.5	1.5	1.9	0.3	0.01
1.00	293.0	0.0	1.4	1.2	1.1	1.1	3.2	0.5	0.02
2.00	289.0	0.0	4.5	2.4	1.9	1.2	5.4	0.8	0.03
0.25	63.0	25.3	1.9	3.9	0.5	8.1	7.3	1.3	0.05
0.50	63.0	25.3	5.6	6.9	0.8	8.5	12.0	1.9	0.07
1.00	62.0	25.3	18.0	10.6	1.7	6.2	19.3	2.7	0.10
2.00	62.0	25.3	52.0	16.2	3.2	5.0	31.1	3.7	0.14
0.25	60.0	28.4	2.1	4.0	0.5	7.5	7.9	1.2	0.05
0.50	60.0	28.4	6.4	7.7	0.8	9.4	12.9	1.8	0.07
1.00	60.0	27.1	19.5	10.2	1.9	5.4	20.2	2.4	0.10
2.00	60.0	26.6	59.0	16.7	3.5	4.7	31.4	4.1	0.16

Block Force and Static Displacement, 100 volt signal			
Parameter	Clamp -6	Clamp 0	Clamp 6
Block Force Amplitude (N)	0.51	1.05	1.28
Displacement Amplitude (mm)	0.60	0.51	0.45

Dynamic displacement, no added tip mass, +/- 100 volt signal			
Parameter	Clamp -6	Clamp 0	Clamp 6
Resonant Frequency (Hz)	183.4	245.8	269.1
Half Power Bandwidth (Hz)	10.8	14.6	70.2
Q Factor	17.0	16.8	3.8
Peak to Peak Deflection at Resonance (mm)	4.70	2.77	0.74
Quasi Static Peak to Peak Deflection (mm)	0.42	0.66	0.35

Dynamic Displacement, 9.3 tip mass, +/- 100 volt signal			
Parameter	Clamp -6	Clamp 0	Clamp 6
Resonant Frequency (Hz)	67.5	92.5	111.7
Half Power Bandwidth (Hz)	3.6	5.4	6.4
Q Factor	18.8	17.1	17.5
Peak to Peak Deflection at Resonance (mm)	6.61	5.07	4.40
Quasi Static Peak to Peak Deflection (mm)	0.37	0.30	0.26

Sensitivity, middle clamp, no added tip mass	
Sensitivity (mV/g)	66.168
Upper Frequency Limit (Hz)	163.0
Resonance (Hz)	285.0
Sensitivity at Resonance (V/g)	3.0

PLOTS

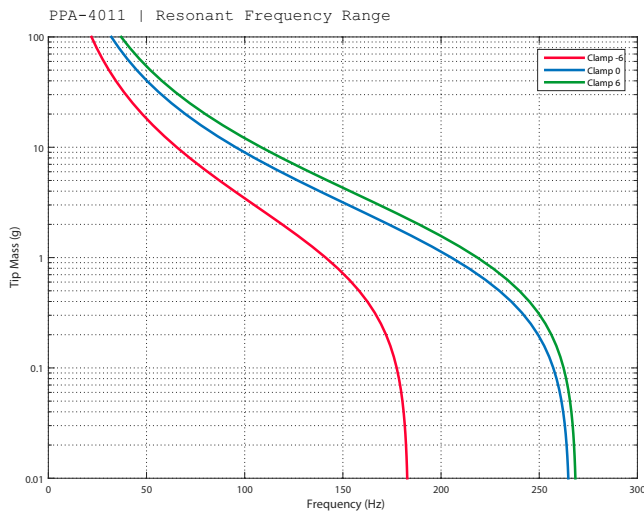

Figure 25: Refer to Section 4.3 for more information on tuning your piezo.

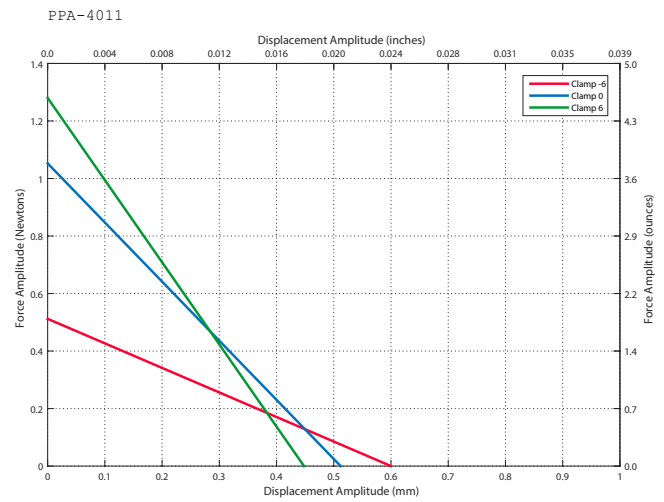

Figure 26: Static displacement and block force are compared for the three different clamp locations. The piezo was driven with 100 volts to generate this data.

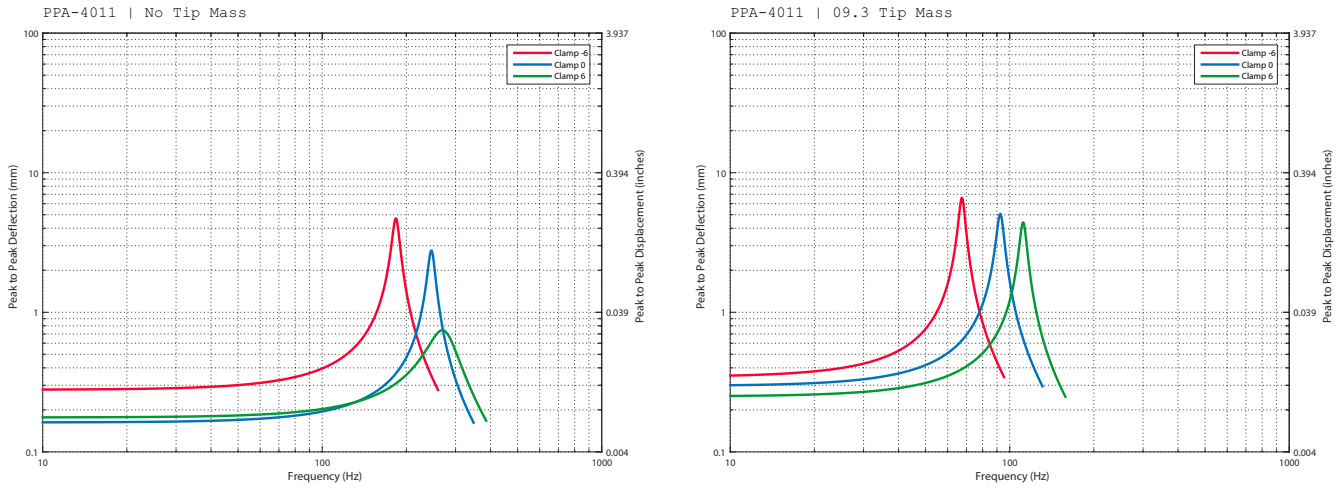

Figure 27: The peak to peak tip displacement is provided for when the piezo is driven with a ± 50 volt signal.

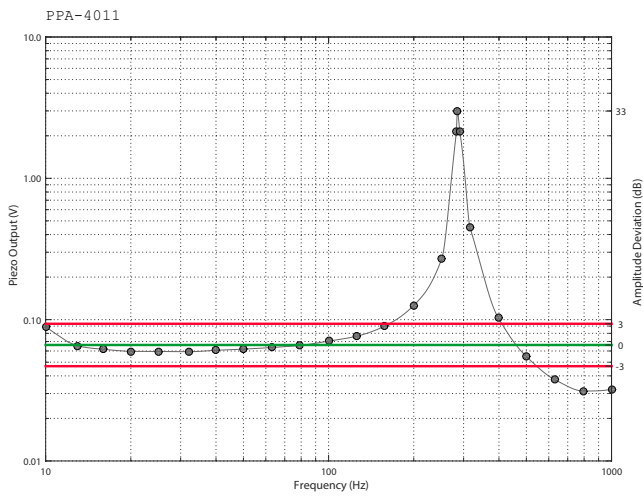

Figure 28: The frequency response of the accelerometer is provided with ± 3 dB error bands to highlight the frequency range where accurate measurement can be expected.

3.1 PIEZO POLARITY & CONNECTING MULTIPLE PIEZOS

Each of the standard PPA products have only two electrical connection points for ease of use as highlighted in Figure 55. Most of these products are poled so that the positive voltage is in the direction of the side with the Midé logo (the side with the copper connection pads). PPA-1012 and PPA-1021 are poled in the opposite direction. If a positive signal is applied to the “Bottom (+)” pad (in line with the poling direction) the piezo wafer will compress in the thickness direction and thus bending upward, toward the side with electrical connection. In applications where the piezo is being used as a sensor or harvester, compressing the piezo through the thickness (bending upward, “out of the page”) will result in a positive voltage to the “Bottom (+)” pad. The opposite is true if applying a negative voltage.

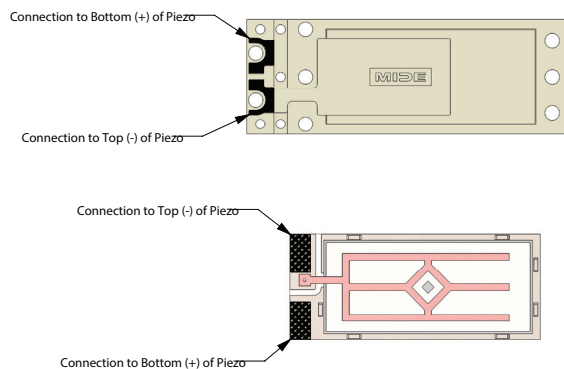

Figure 55: The two copper pads for electrical termination are highlighted. The two steel pads for electrical termination are highlighted on the PPA-1001 product.

For bimorph products the bottom wafer is poled in the opposite direction as the wafer on top, away from the center of the pack. The electrical connections are then made with the two wafers connected in parallel; but in such a way where the two wafers always act in the opposite direction of one another (one compresses, while the other extends). This is the desired configuration for when using these products as benders. The quadmorph wires the four piezos similarly to the bimorphs but as two sets of pairs. The first two wafers act in unison but in the opposite direction as the bottom two wafers which act in unison with one another.

Admittedly, the polarity direction can be confusing. Midé recommends to do a few bench tests upon receipt of these products to gain a better understanding of this directionality.

If you prefer to use the product as a stack where the two (or four) wafers work in unison with one another, Midé requires a minimum order size of 25 units and a lead time of 4 weeks. There will be no additional fee though.

Piezos can be connected to one another in either series or parallel. Series connection will double the open-circuit voltage compared to a single wafer, and the effective capacitance will be 1/2 the single-wafer capacitance (assuming each wafer is the same capacitance). Parallel connection will double the current compared to a single wafer, and the effective capacitance will be double the single-wafer value. For most applications, parallel connection is recommended. Regardless of series or parallel connection, the power generated by the Vulture™ Energy Harvester will be the same.

3.2 SOLDER

The recommended electrical connection method is to solder directly to the two copper pads on the pack for most of these products. Please note that the PPA-1001 has steel pads which are not designed for soldering. Please practice safe soldering techniques and be sure to apply some electrical tape or insulating epoxy over the connections to prevent them from shorting to one another or person.

WARNING: Risk of eye injury; always wear safety goggles when working with hot solder.

WARNING: Risk of lung irritation; avoid direct inhalation of solder fumes. Always solder in well ventilated areas.

WARNING: Risk of severe burns; soldering iron tips become very hot when used. NEVER touch the iron tip.

When connection to the piezo is being made by soldering there are countless forms of cabling to use. Midé typically uses bare cable but here are two options that have worked well: [Header Pin Receptacle to Solder Pins](#), and [BNC Connector to Bare Wire](#).

3.3 PPA-7001 RING TERMINAL CABLE

The PPA products, with the exception of PPA-1001, were designed for using a M3 Ring Terminal connection as shown in Figure 56. Refer to the product drawing and/or 3D model for exact location of these holes; they are spaced 10.5 mm apart.

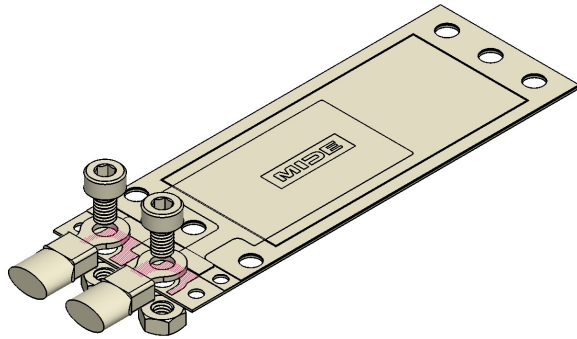

Figure 56: Electrical connection to the PPA products can be made with simple M3 Ring Terminals.

The PPA-7001 offers a clean cable from two bare wires to two M3 ring terminals. The PPA-7001 uses two ring terminals purchased through Digi-Key: [WM9606-ND](#). The cabling is 22 gauge and also purchased through Digi-Key: [E1002S-1000-ND](#). Any M3 nut and bolt will work to secure the terminals to the copper pads; but Midé uses two from McMaster: [90128A187](#) and [90591A121](#). Proper mounting torque of 1 N-m (8.85 in-lb) should be used. Two cables are included as part of the PPA-9001 clamping kit and not offered for individual sale. One cable is approximately 150 mm (6 inches) and the other is approximately 1.8 meters (6 feet). A simple drawing of the cable is provided in Figure 57.

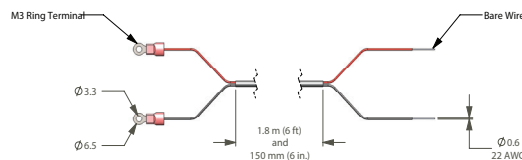

Figure 57: PPA-7001 cable incorporates two M3 ring terminals and either a 1.8 meter or 150 mm cable length. Dimensions are provided in mm.

Be sure to apply some electrical tape or insulating epoxy over the connections to prevent them from shorting to one another or person.

3.4 CONDUCTIVE HARDWARE DIRECTLY TO PCB

Conductive hardware can be used in place of ring terminals when the piezo beam is directly placed on a PCB. Two brass M3 bolts can be used to connect the piezo pack to a PC board if large pre-tinned pads (shown as shaded rings in Figure 58) are on the underside of the board. In this configuration the piezo pack would lay on top of the PCB with the brass bolts bringing connection down through the PCB to the underside of the board where a conductive nut would be used to secure the bolt. This nut would electrically connect to the large pads on the underside of the board. Proper mounting torque of 1 N-m (8.85 in-lb) should be used. When mounting directly to the PCB use the PPA-5004 clamp or similar for accurate clamping and operation.

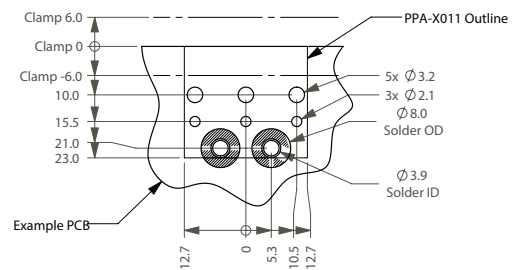

Figure 58: Example PCB configuration for directly mounting and connecting a PPA product to a PCB. Dimensions are shown as millimeters.

Be sure to apply some electrical tape or insulating epoxy over the connections to prevent them from shorting to one another or person.

3.5 SPRING LOADED CONTACTS (POGO PINS)

All of the PPA products can be connected to with spring loaded contacts, or pogo pins. There are a number of products on the market that work well but Midé has had good experience with the products made by [Mill-Max](#). It is recommended to apply some insulating potting compound around the contacts to protect them in long term operation and against shock and vibration.

3.6 IC HOOK AND ALLIGATOR CLIPS

IC hooks can be used for quick connection to all of these products but the hook can become disconnected rather easily. The PPA-1001 product has raised bumps that enables connection with an alligator clip. Alligator clips are difficult to connect with for the other products.



Figure 59: Simple alligator clips and/or IC hooks can be used for quick and simple testing. These are not advisable as long term connection solutions.

3.7 CONNECTORS

Midé can include a connector with each unit but this involves a custom design. Some of Midé's previous QuickPack and Vulture products had connectors similar to these [Flat Flex Cable Connectors](#). Midé has also utilized the flex circuit to design in a flat flex cable to be plugged directly into a ZIF connector. If a built in connector or some other alternative electrical termination method is desired, a custom solution can be designed. There will be an NRE of over \$2K for such a design. See Section 7 for more information and an example photo.

4.1 PPA-9001 CLAMP KIT

Effective clamping is vital for the piezo products to perform properly. If these products are used in a cantilever configuration it is strongly recommended to purchase a PPA-9001 general purpose kit, or PPA-9004 clamp enclosure kit during initial product evaluation.

4.1.1. LIST OF CONTENTS

The PPA-9001 clamp kit includes all the necessary materials and parts to get started with testing and evaluating the piezo product. This kit was designed for initial testing and feasibility analysis; but it can also be incorporated into your end product/system. Midé also offers design services if a modified clamp configuration is required. Figure 60 and Table 2 list and identify the contents of this kit.

Table 2: PPA-9001 Clamp Kit Contents.

Description	Part Number	Quantity	Mass (g)
Nut Driver (5.5 mm)	52965A17	1	
Hex Key (2.5 mm)	5334A32	1	
Orange Electrical Tape (0.75"x 22 yards)	7619A19	1	
Vibra-Title Reusable Threadlocker	75145A68	1	
M3 Bolt, 5mm Long (Ultra Corrosion Resistant Steel)	91274A101	20	0.7
M3 Bolt, 12mm Long (Ultra Corrosion Resistant Steel)	91274A106	20	1.0
M3 Bolt, 20mm Long (Ultra Corrosion Resistant Steel)	91274A109	5	1.4
M3 Nut (Zinc Plated Steel)	90591A121	100	0.4
M3 Washer (Zinc Plated Steel)	91166A210	100	0.2
Magnet w/M3 Through Hole, 8.8 lb of Pull Force	MM-B-16	8	5.7
Clamp Base (Glass Filled Nylon-12)	PPA-5001	1	
Clamp Bar (Aluminum 6061, 1/16" Thick)	PPA-5002	2	
Tip Mass Accessory (Aluminum 6061, 1/16" Thick)	PPA-5003	2	
M3 Ring Terminals to Bare Wire Cable, 1.8 meters (6 feet)	PPA-7001-1800	1	
M3 Ring Terminals to Bare Wire Cable, 150mm (6 in)	PPA-7001-0150	1	

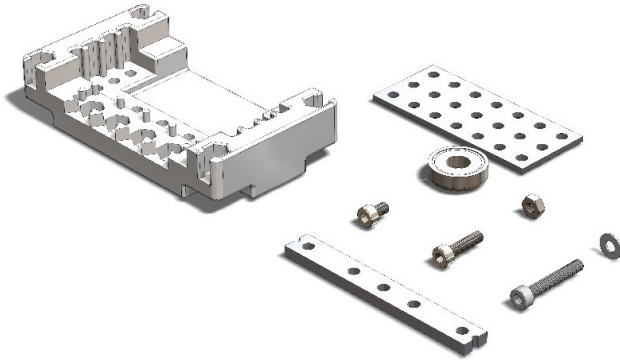

Figure 60: All individual hardware components of the clamp kit are shown.

If additional hardware is desired, all hardware is available through [McMaster-Carr](#) and the part numbers listed in Table 2 are the distributor part numbers. Additional magnets can be purchased through [K&J Magnetics](#). LEDs are purchased through [Digi-Key](#). The bolts, nuts, washers, and magnets can be used as tip masses for tuning your piezo product. Each product has at least one hole at the tip for mounting these components. The PPA-5003 tip mass mounting accessory has a 3x7 grid of holes meant for mating with a PPA product and providing greater customization of where tip masses are located.

The boundary conditions at the clamping line is critical for optimal performance; therefore Midé uses aluminum 6061 for the PPA-5002 clamp bar. In order to ensure vibrations are not dampened through the clamp base, the PPA-5001 base piece is 3D printed from a stiff glass filled nylon material. These are 3D printed with laser sintering to keep costs down. The 3D model of this assembly and components is available to download here. Dimensions for the two parts are provided in Figure 61 and Figure 62.

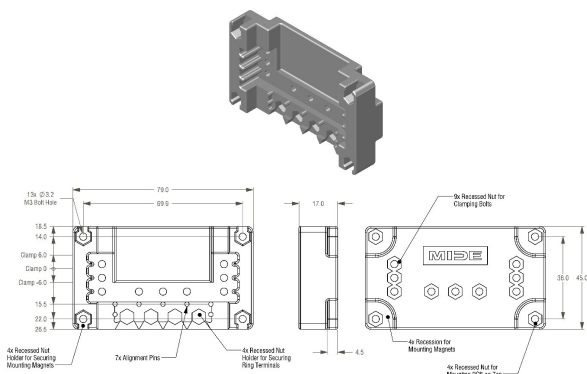

Figure 61: Dimensions (mm) of the PA-5001 clamp base are provided. This base provides interfaces to clamp the piezo products, secure ring terminals, utilize mounting magnets, bolt the base down to another structure, and interfaces to secure a PCB to the top.

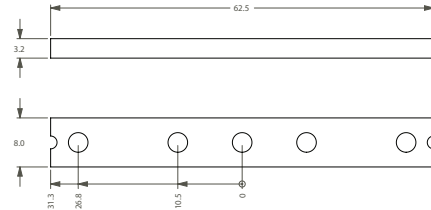

Figure 62: The dimensions (mm) of the PPA-5002 clamp bar are provided.

4.1.2. CLAMP LOCATION

These PPA products were designed for three clamp locations. These clamp lines are detailed on the drawing for each product and shown below with the PPA-9001 clamping kit. The middle clamp location (Clamp 0) is the default position for all products. With this clamp line 5.3 mm (0.21 in) of the piezo wafer is clamped. This ensures adequate strain in the piezo during energy harvesting and sensing. It also provides a secure moment for delivering high force output in actuation. Clamp 6 extends 6mm toward the tip of the piezo pack. This clamp location is useful when trying to increase the resonant frequency of the beam. Clamp -6 extends 6mm away from the tip of the piezo beam. With this clamp configuration the piezo wafer is not directly clamped. This is ideal for applications where displacement performance is paramount. Not clamping on the piezo makes the pack much less stiff, and thus drives down the resonant frequency. Due to the decreased strain delivered to the piezo it also lengthens the lifetime of the pack. This clamp location is not recommended for energy harvesting, sensing, or force delivery applications due to the lack of strain.

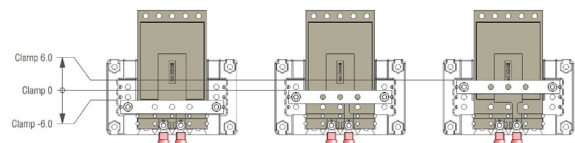

Figure 63: The three clamp locations are shown for the PPA products.

The PPA-1001 does not have the same configuration as the other products and thus only can utilize two of the clamp locations as shown in Figure 64. To mount the PPA product, press the back edge of the beam against the alignment pins so that they are tangent. Midé also recommends that a layer of electrical tape be placed over the contacts pads on the PPA-1001. The PPA-5002 clamp bar is conductive so great care should be made to ensure that it does not short out the two contact pads.

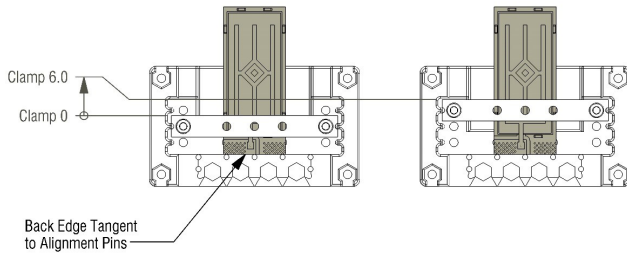

Figure 64: The PPA-1001 only utilizes the Clamp 0 and Clamp 6 locations.

CAUTION: The PPA-1001 cannot be clamped in the Clamp -6 location. Failure to put electric tape over the contact pads of the product can result in the PPA-5002 clamp bar shorting the piezo. This can damage the drive electronics and/or result in no output for energy harvesting or sensing applications.

4.1.3. CLAMPING INSTRUCTIONS

Clamping the products is made easy with the PPA-5001 clamp base and PPA-5002 clamp bars. Select the desirable clamp location and align one clamp bar with the side alignment pins at the desired location. Then place the piezo beam on top of the clamp bar, using the alignment pins at the back of the clamp base. The second clamp bar is then placed on top, using the side alignment pins. Two 12mm M3 bolts can then be screwed down after nuts are placed in the bottom nut recesses. These recessed areas keep the nuts captive so that the bolts can be screwed down. The recommended torque that should be used is 1 N-m (8.85 in-lb). If a torque wrench is not available be sure to just use the provided hex key T handle and hand tighten to ensure the bolts are not over tightened and damage the piezo.

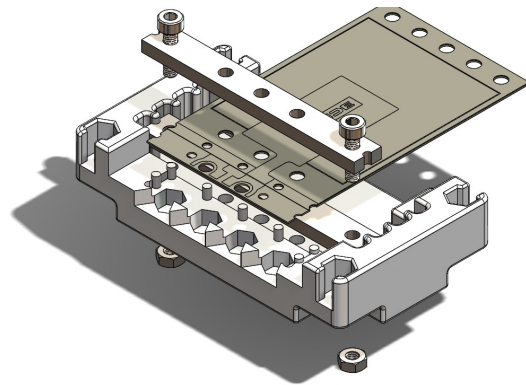

Figure 65: Clamping the piezo products is possible with two recessed nuts, two M3 12mm bolts, two PPA-5002 clamp bars and the PPA-5001 clamp base.

CAUTION: Over tightening the bolts could damage the piezo.

Most applications that require these piezo products will have heavy vibration either from the piezos or environmental vibration that the piezos are sensing/harvesting from. Vibration can often loosen bolts over time which is why threadlocker is included with each kit. This threadlocker is reusable for testing and evaluation; but for long term testing Midé suggests a more permanent threadlocker solution. It is imperative to use some form of threadlocker or the boundary conditions at the clamp or tip mass can change with time which will result in a change of performance over time.

4.1.4. EXAMPLE CONFIGURATIONS

The PPA-9001 clamping kit was designed for evaluation purposes and for Midé's wide range of customers and end applications. Therefore it was designed to be used in a great number of different configurations. Not only are there different clamp lines, there are different methods of mounting the base to your vibrating structure and mounting electronics or other hardware to the clamp base. Figure 66 provides some example mounting methods.

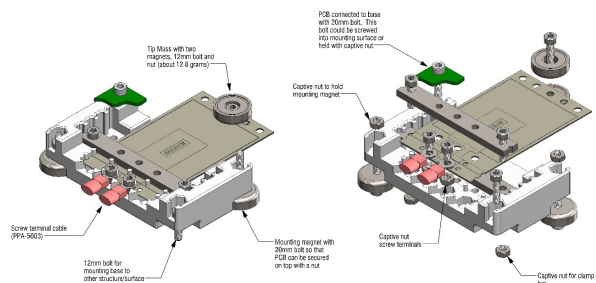

Figure 66: Various methods of securing the clamp base to its intended surface/structure and/or methods of securing a PCB or other hardware to the base are shown.

The clamp base was also designed to hold more than one product at a time. This could be useful if you are looking to expand the frequency bandwidth (have several units tuned to different frequencies) for example. Figure 67 shows how several products can be clamped with one clamp assembly.

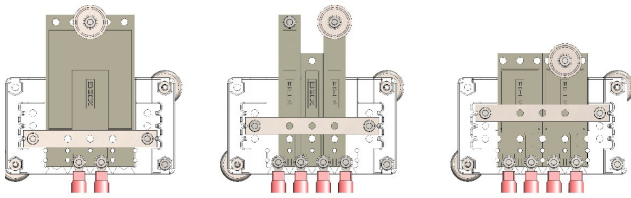

Figure 67: The PPA-5001 clamp base can hold one of the two of the PPA-1014 and PPA-2014 products and three of the PPA-1021 and PPA-1022 products as shown.

There are a host of other configurations that can be used with this clamp kit, including stacking of several bases onto one-another (longer bolts may be required)! Midé encourages you to be creative and would love to hear/see what you created!

Table 3: PPA-9004 Clamp Kit Contents.

Type	Description	Part Number	Quantity
3/32" Ball-end L-keys	Steel	5503A16, McMaster	1
Precise-Control Screwdriver	0.079" Slotted	52985A12, McMaster	1
Electrical Tape	Orange Electrical Tape 3/4" Wide, 22 yds long	7619A19, McMaster	1
M3 Nut	316 Stainless Steel	94150A325, McMaster	20
4-40 Nut	316 Stainless Steel	90257A005, McMaster	10
M3 Bolt, 6mm	316 Stainless Steel	90116A151, McMaster	10
M3 Flat Head Bolt, 10mm	316 Stainless Steel	91801A156, McMaster	10
4-40 7/8" Socket Head Cap Screw	316 Stainless Steel	92185A113, McMaster	10
Enclosure Bottom	PA 850 (Black Nylon-11) SLS	PPA-5008, Midé	2
Enclosure Top	Watershed XC 11122 Normal Res SLA	PPA-5009, Midé	1
Clamp Plate (-6mm)	6061 Aluminum, 1/8" thick	PPA-5005, Midé	2
Clamp Plate (0mm)	6061 Aluminum, 1/8" thick	PPA-5004 or PPA-5006, Midé	2
Tip Mass Accessory	Rubber Button	95495K2, McMaster	2
Tip Mass Accessory	Magnet	MM-B-16, K&J Magnetics	1
Strain Relief	Rubber Cable Strain Relief	1467094, ISC Engineering	2
Cable	2 conductor cable	E1002S-1000-ND, Digkey	2

4.2 PPA-9004 CLAMP ENCLOSURE KIT

Similar to the PPA-9001 kit, the PPA-9004 clamp enclosure kit is a valuable tool in evaluating and using Midé's piezo products. Designed for the PPA-X014 and PPA-X022 devices, the PPA-9004 kit includes a versatile clamp enclosure, which can be used to test the devices in a number of configurations. The PPA-9004, is particularly suited for usage cases which can benefit from having a self-contained device, such as haptic feedback and vibration energy harvesting.

4.2.1 LIST OF CONTENTS

The PPA-9004 clamp enclosure kit includes a collection of components useful in testing the smaller PPA actuators (PPA-1014, 2014, 1022). Similar to the PPA-9001 clamp kit, the PPA-9004 clamp enclosure kit was designed for initial testing and feasibility analysis; but it can also be incorporated into your end product/system. Figure 68, and Table 3 list and identify the contents of this kit.



Figure 68: The hardware components of the clamp enclosure kit are shown. For simplicity the actual wiring, and some of the repeated bolts etc are not shown.

Some of the enclosure kit components are custom Midé parts, but the majority of the hardware is commercially available through [McMaster](#), [K&J Magnetics](#), [ISC Engineering](#), and [Digikey](#). The part numbers listed in Table 3 are the distributor part numbers, or Midé part numbers for the custom pieces. The bolts, nuts, washers, and magnets can be used as tip masses for tuning your piezo product. Also, a rubber bumper is included, which may be useful for tactile/haptic feedback, damper, sealing or other applications.

The non-COTS clamp enclosure kit pieces are the two enclosure “bases” made from 3D printed black SLS material, the clear 3D printed SLA enclosure top, and water-jet cut aluminum 6061 clamp plates (-6mm, and 0mm pairs). The enclosure is designed such that a piezo is fitted between two matching clamp plates and mounted onto one of the “bases”. Depending on the desired configuration, either the clear top or the other base can be fitted on the bottom base to complete an enclosure. The thinner clear top has a small hole, which is designed to be used with the included bumper. This configuration may be useful to evaluate tactile feedback. Alternatively, the other black base can be fitted onto the bottom base, to construct a thicker but more versatile enclosure from a mounting hardware perspective. Although not included in the kit, the enclosure kit can also accept clamp plates for the +6mm clamp position.

The PPA-9004 enclosure assembly is designed primarily for actuators with soldered wires; where-as the PPA-9001 clamp kit is designed primarily for ring terminal connections. That being said, the 9004 kit does have accommodations in the base design for a ring terminal like alternative connection approach (using non-conductive bolts/nuts [for voltage protection] and conductive

terminals and washers), please contact Midé for instructions. For the default soldered wire connection, the enclosure kit comes with wires with rubber strain relief. The strain relief is compression fit into a slot on the side of the base and top.

The 3D models of the assembly and components are available to download [here](#). Dimensions for the parts are provided in Figure 69, Figure 70, and Figure 71.



Figure 69: PPA-5008 clamp enclosure base and PPA-5009 clamp enclosure top are shown above. This base provides interfaces to clamp the piezo products, incorporate the wiring strain relief, utilize mounting magnets, bolt the base down to another structure, and secure the top, the mirrored base or even a PCB to the top.

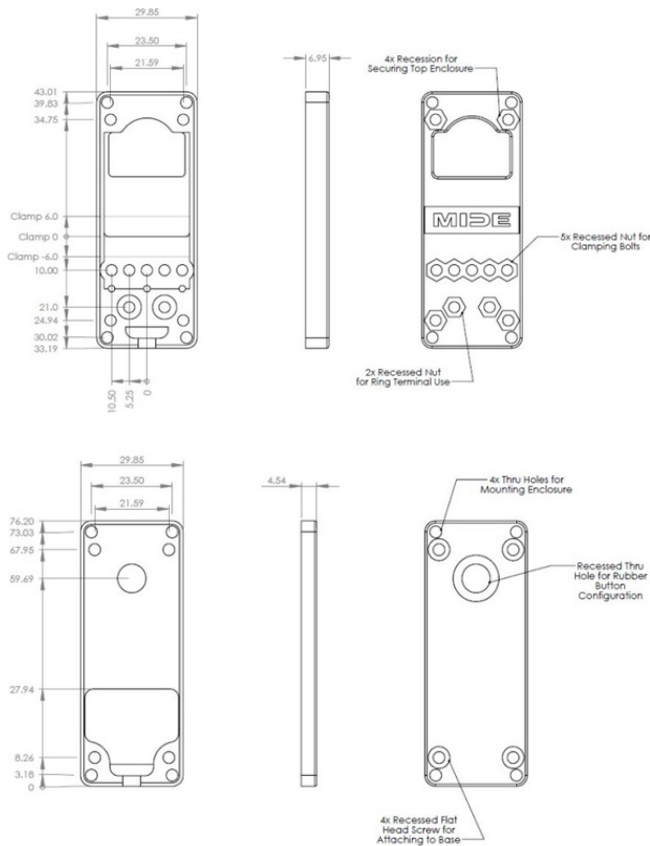

Figure 70: Dimensions (mm) of the PPA-5008 clamp enclosure base and PPA-5009 clamp enclosure top are shown above.

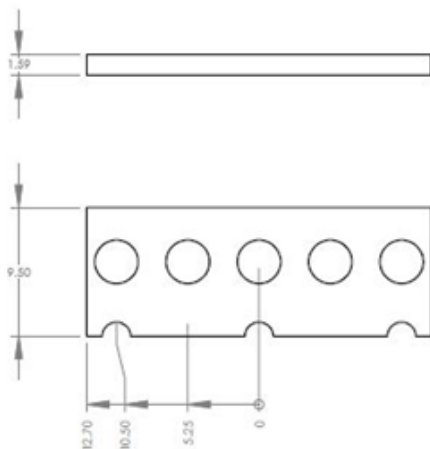

Figure 71: The dimensions (mm) of the PPA-5005 (-6mm) clamp plate, and PPA-5006 (0mm clamp plate). Note, the enclosure kit may be supplied with the PPA-5004 (0mm clamp plate, 3 holes), in place of the PPA-5006 at Mide's discretion.

4.2.2 CLAMP LOCATIONS

The PPA products were designed for three clamp locations. These clamp lines are detailed on the drawing for each product and shown below with the PPA-9004 clamp enclosure kit base. The middle clamp location (Clamp 0) is the default position for all products. With this clamp line 5.3 mm (0.21 in) of the piezo wafer is clamped. This ensures adequate strain in the piezo during energy harvesting and sensing. It also provides a secure moment for delivering high force output in actuation. Clamp +6 extends 6mm toward the tip of the piezo pack. This clamp location is useful when trying to increase the resonant frequency of the beam. Clamp -6 retracts 6mm away from the tip of the piezo beam. With this clamp configuration the piezo wafer is not directly clamped. This is ideal for applications where displacement performance is paramount. Not clamping on the piezo makes the pack much less stiff, and thus drives down the resonant frequency. Due to the decreased strain delivered to the piezo it also lengthens the lifetime of the pack. This clamp location is recommended for actuation requiring larger deflections. For the PPA-9004, two clamp plates are used. The bottom plate offsets the actuator off of the base slightly; the base was designed this way to improve test modularity with other clamp positions.

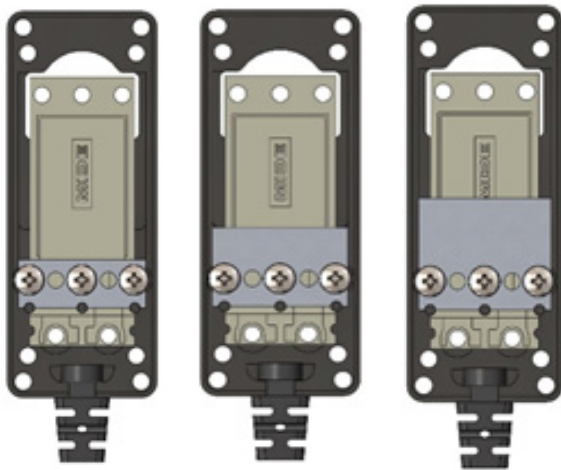

Figure 72: The three clamp locations are shown for the PPA products.

4.2.3 CLAMPING INSTRUCTIONS

The PPA-9004 clamp enclosure kit relies on sets of machined clamp plates, designed to clamp the actuators in the different clamp locations (-6mm, 0mm, +6mm) and onto the base. This differs from the approach with the PPA-9001 kits' movable clamp bar. The clamp plates allow the overall width of the enclosure to be smaller. However, similarly to the PPA-9001 base design, the PPA-5008 base includes alignment dowels to set the actuators and clamp plates onto the base. In setting up the basic configuration, first start with placing the desired clamp plate (the kit includes only the -6mm, and 0mm clamps at this time), into the enclosure base using the alignment pins as guides. Then using the same alignment pins place the chosen actuator onto the base and bottom clamp plate. The second matching clamp plate is then placed on top of the piezo, again using alignment pin dowels. Finally, three 6mm long low profile M3 bolts are used to clamp the clamp plates and actuator to the base via M3 nuts captured in the bottom of the base nut recesses. The recommended torque that should be used is 1 N-m (8.85 in-lb). If a torque wrench is not available be sure to just use the provided hex key T handle and hand tighten to ensure the bolts are not over tightened and damage the piezo.

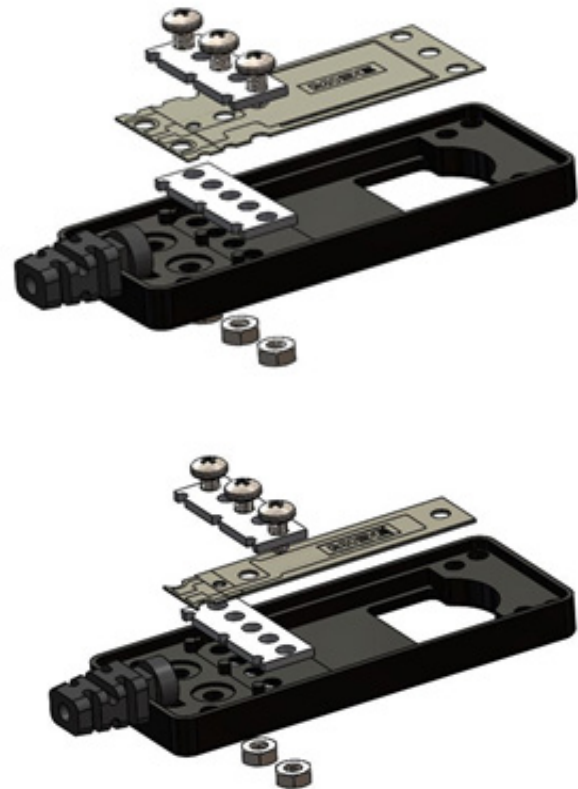

Figure 73: Clamping the piezo products is possible with three recessed nuts, three low profile M3 bolts, two clamp plates (-6mm PPA-5005 shown) and the PPA-5008 clamp enclosure base. Left: PPA-X014. Right: PPA-X022.

CAUTION: Over tightening the bolts could damage the piezo.

Similar to the general purpose clamp kit, Midé has included threadlocker in the enclosure kit, such that vibrations do not loosen the bolts over time. This threadlocker is reusable for testing and evaluation; but for long term testing Midé suggests a more permanent threadlocker solution. It is imperative to use some form of threadlocker or the boundary conditions at the clamp or tip mass can change with time which will result in a change of performance over time.

4.2.4 EXAMPLE CONFIGURATIONS

The PPA-9004 clamp enclosure kit was primarily designed for haptic/tactile feedback and energy harvesting evaluation purposes, but it can support other general purpose usage. The kit comes with two “bases” and one “top”. Effectively, one could make two different enclosures with the kit; one using one of the bases and the clear top, the other with two of the bases. These two primary configurations are shown in Figure 74.



Figure 74: Left: Enclosure clamp base with thinner clear top paired with tactile bumper. Right: Enclosure clamp where two “bases” are used to create an enclosure.

Both configurations are shown with the bumper or mass on top; however, masses could also be added to the bottom of the actuator to manipulate resonance and performance. Make sure to account for actuator/mass/bumper swing when mounting these devices. The enclosures (especially when using the bumper and clear top) are designed to allow the bumper or mass to swing outward and beyond the envelope of the device.

As two clamp plates are used in the enclosure design, one could also forego the base entirely, and create a very simple clamp, with just the actuator, clamp plates, M3 bolts and nuts. See Figure 75 for examples.

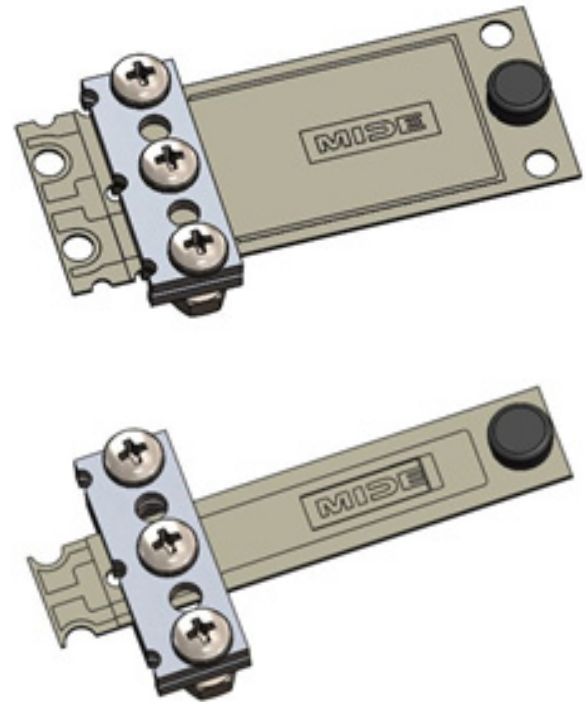

Figure 75: Actuator clamp configuration using only the mounting hardware and -6mm clamp plates. Left: PPA-X014. Right: PPA-X022

CAUTION: To avoid being shocked, make sure that you never touch the electrical pads when energized, and make sure clamping hardware is not shorting in any way to the pads. It is wise to use the orange electrical tape to insulate the pads of the PPA device during use, especially if you choose to try the configuration in Figure 67.

There are many other configurations possible with the clamp enclosure kit. If designing our actuators into your own custom enclosure, you can even incorporate the clamp plates or use them as a mounting template in your design. Interesting side note, Midé designed the enclosure(s) and its mounting holes to match the [Slam Stick data logger](#) sensing products. So it is feasible to mount the devices together!

4.2.5 PPA-5003 TIP MASS ACCESSORY

The PPA-5003 tip mass mounting accessory provides a 3x7 grid of M3 mounting holes for mating to the PPA products and adding tip mass in many different configurations. This plate is water jet cut from aluminum 6061.

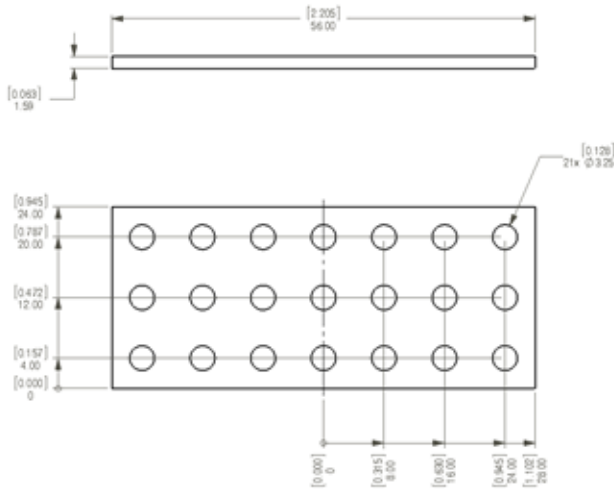

Figure 76: The PPA-5003 tip mass mounting accessory provides a 3x7 grid of M3 mounting holes for mating to the PPA products and adding tip mass in many different configurations. This is water jet cut from aluminum 6061. Dimensions are listed in both millimeters and inches.

This grid can be used to extend the beam length of the piezo which can reduce the resonance dramatically, important for a lot of folks interested in human based vibration. It can also be used to induce a more “rocking” mode shape than strictly a bending one which can create more strain in the piezo. Due to its grid like pattern it can also be used to connect a number of PPA products for very interesting harvesting potential and haptic feedback control. Get creative with this accessory and let Midé know how you used it!

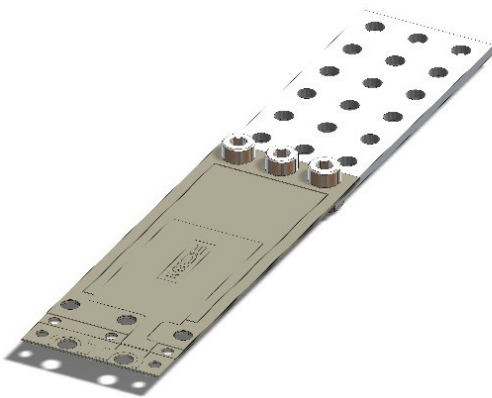

Figure 77: The PPA-5003 is shown here extending the beam of a PPA-1011 product to reduce the resonant frequency.

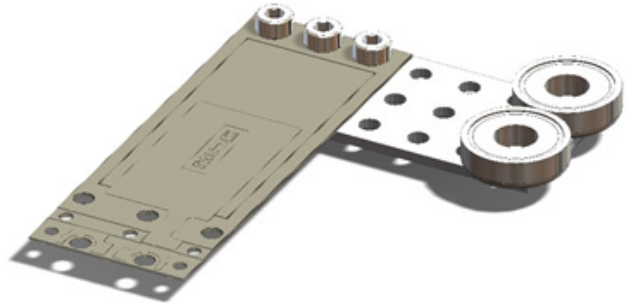

Figure 78: The PPA-5003 is shown here with tip masses mounted next to the PPA-1011 product to induce a shaking/twisting mode instead of the pure bending mode. This will induce more strain in the piezo.

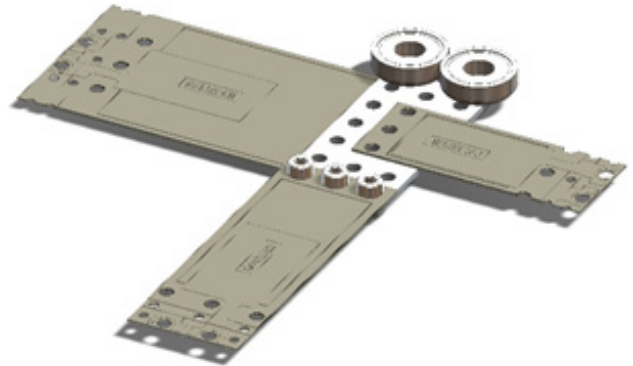

Figure 79: The PPA-5003 is shown with several products all connected to it. This highlights how the accessory can be used to pair different products and potentially expand the bandwidth of harvestable frequencies.

4.3 PPA-5004/5/6/7 CLAMP PLATES

The clamp bars included in the PPA-9001 kit are very versatile from a configuration and trialing perspective. The PPA-9001 kit is even a viable solution for small to medium volume production runs. However, a different clamping solution may be desired for larger production runs or space constrained implementations. Due to this, Midé has designed several sets of clamp plates that provide a narrower clamp solution for the PPA actuators. The PPA-5004, 5005, 5006, and 5007 clamp plates are water jet cut from aluminum 6061 and can be used to clamp the PPA-X011, PPA-X014, and PPA-102X products. M3 bolts or 4-40 bolts can be used for clamping (follow clamp instructions presented

in Section 4.1.3). There are three half circles meant to be used with M2 dowel pins (5/64" can also be be used) to properly align the edge of the clamp with the piezo. Each of the clamp plates clamp the PPA actuators at a specific clamp line, (-6mm PPA-5005, 0mm PPA-5004/6, +6mm PPA-5007). If a different clamp location is needed, contact Midé for more information.

Notes: A set of PPA-5005 (-6mm) and PPA-5004 or 5006 clamp plates are included in the PPA-9004 enclosure kit. The PPA-5004 and PPA-5006 clamp plates are identical, except the PPA-5006 has five holes instead of three. The PPA-5005/6/7 clamp plates have 5 holes to allow more flexibility in possible custom piezo designs.

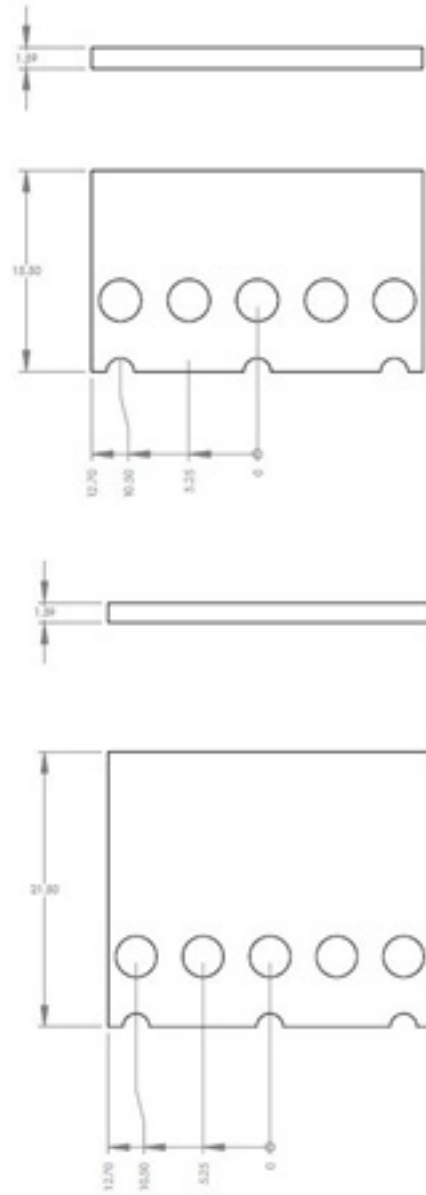
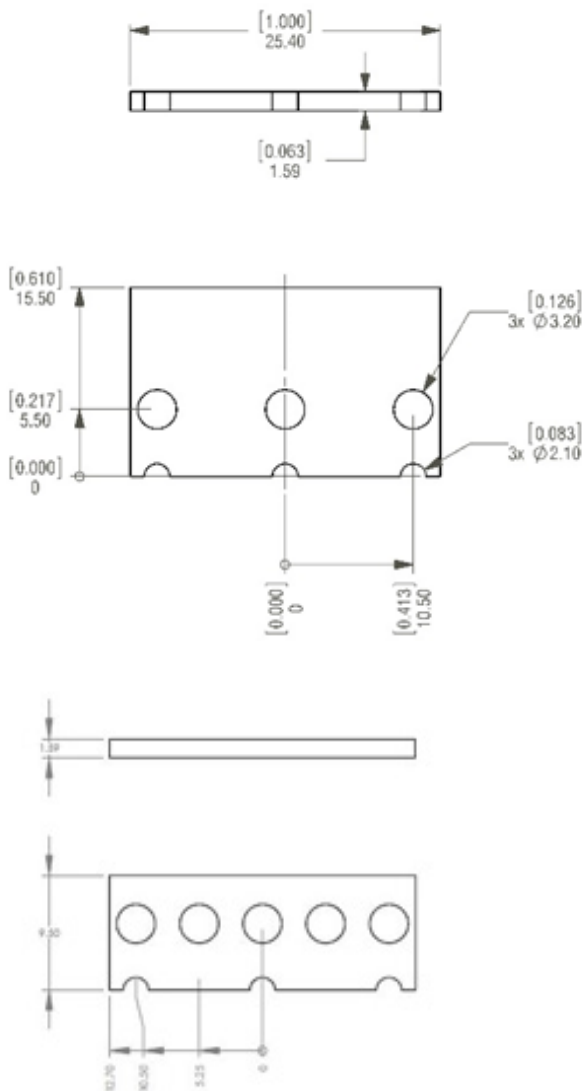

Figure 80: The PPA-5004/5/6/7 clamp plates are low profile clamp solutions for designing directly into an end system. Top: PPA-5004 0mm clamp, Bottom (Left to Right): PPA-5005 [-6mm], PPA-5006 [0mm, 5 holes], PPA-5007 [+6mm].

4.4 TUNING

To ensure the most efficient energy harvesting (or tip deflection) it is essential to tune the piezo beam's natural frequency to match that of the vibrating source (or drive frequency). Tuning is performed in one of two ways: changing the clamp position, or adding/subtracting tip mass. Each of the PPA products include at least one hole at the tip so that tip masses can be adequately secured and in a repeatable location.

4.4.1 CALCULATING THE REQUIRED TIP MASS

In order to determine the appropriate clamp position and required tip mass, Midé conveniently provided the effective stiffness (k) and effective mass (m) of each product in each of the three clamp configurations. The relationship between natural frequency (f) and added tip mass (m_t) is provided in the following two equations depending on what you're solving for. Be sure to convert the tip mass and effective mass to kilograms, not grams.

$$f = \frac{\sqrt{\frac{k}{m + m_t}}}{2\pi}$$

$$m_t = \frac{k}{(2\pi f)^2} - m$$

Let's use an example where we would like to tune the PPA-2011 product to 60 Hz. Referencing the resonant frequency range plot (included again in Figure 81) we can see that each of the three clamp locations can be tuned to 60 Hz. We decide to use the Clamp 0 location because we know Clamp -6 provides little strain in the piezo and the Clamp 6 location requires much more tip mass than Clamp 0. Referencing the effective stiffness and mass from the product's specifications we calculate the required tip mass as shown, which comes to 3.4 grams.

$$m_t = \frac{k}{(2\pi f)^2} - m = \frac{574}{(2\pi 60)^2} - \frac{0.6}{1000} = 0.0034$$

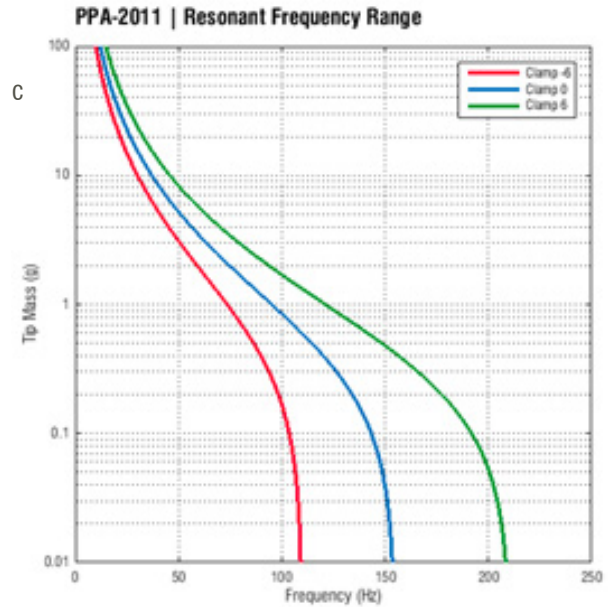

Figure 81: The PPA-2011 frequency range plot is provided as an example.

Please note that the stiffness and effective mass for each product is provided as a guide to estimate the required tip mass. The natural frequency of each product is impacted by temperature, manufacturing tolerances, clamp conditions, even the drive amplitude or vibration amplitude. In energy harvesting applications the resonance can change depending on the load being powered by the harvester. It's important to test each product in the desired operating environment to accurately ensure proper tuning has been achieved.

Also note that these tip mass equations only work when adding tip mass centered over the tip mass holes on each product. If you are using the PPA-5003 tip mass accessory to add mass at other locations, these equations will be invalid. Also note that asymmetric tip mass loading will be invalid for these equations.

4.4.2 ADDING TIP MASS

Each of the PPA products include at least one hole at the tip for mounting tip masses. Included in the PPA-9001 kit are nuts, bolts, washers, and magnets which can be used as tip masses; but virtually anything can be used. Customers can make their own tip mass structures to mate with these mounting holes and provide the perfect amount of mass. It is important to use threadlocker or some other adhesive once the tip mass has been

added so that the mass doesn't come dislodged during operation.

Midé encourages you to get creative with how tip mass is added. Sometimes asymmetric loading can be beneficial because it results in a twisting mode which can induce more strain in the piezo. Use the PPA-5003 tip mass mounting accessory for more customization and control on modal shapes and resonances. Please share your configuration with Midé and other customers!

4.4.3 DETERMINING THE CHARACTERISTICS OF THE VIBRATION SOURCE

Each of the PPA products can be used as a sensor and the easiest way to measure the frequency and amplitude of the vibration source is to connect the output from the piezo to an oscilloscope. The oscilloscope will measure the frequency of the vibration and display a voltage output of the piezo. Referring to each products sensitivity (so long as the frequency is below the specified upper limit) will provide a rough estimate of the amplitude of the vibration.

Alternatively Midé offers a range of vibration data logging products, the Slam Stick suite that incorporates the data acquisition, sensors, and power into one small, easy to use solution. Free analysis software is included so that FFTs can be generated with data gather by the device to determine the relative strength of each frequency. Also check out Midé's [Simple Harmonic Motion calculator](#) to learn more on the relationship between acceleration, displacement, and velocity amplitude with frequency.

4.4.4 DETERMINING RESONANCE OF THE PIEZO BEAM

The resonance of the beam is best determined by capturing what frequency the device "rings out" after being excited by a mechanical impulse. The easiest way to perform this type of tuning is to properly mount and clamp the product to a rigid structure. Next, attach the piezo's output directly to an oscilloscope for monitoring. Add the appropriate tip mass to the end of the cantilevered beam, do not permanently adhere the tip mass yet. Apply an impulse mechanical load by very lightly "flicking" the end of the beam. This will cause the beam to "ring out". The frequency of the decaying wave is the natural frequency that the beam is currently tuned to. Add more mass to reduce the resonance and subtract some to increase the natural frequency.

4.5 BONDING

Midé's recommends the LOCTITE® Hysol® E-120HP™ epoxy for direct bonding of its PPA piezo products to a structure. This two-part, 24-hour cure, high-performance aerospace grade structural epoxy provides excellent adhesion to the piezo polyimide and FR4 exteriors. Midé does not distribute the epoxy but it is available [online](#).

MATERIAL PROPERTIES

5.1 PIEZOELECTRIC PROPERTIES

Property	Symbol	Units	PZT 5 A	PZT 5H	PMN-PT
Dielectric Constant (1KHz)	K'_3		1900	3800	5400
Dielectric Loss Factor (1KHz)	$\tan\delta_e$	%	1.8	2.0	≤ 0.6
Density	ρ	g/cm ³	7.8	7.8	8.0
Curie Point	T_c	°C	350	225	> 142
Mechanical Quality Factor	Q_m		80	30	80
Coercive Field (Measured <1 Hz)	E_c	kV/cm	12.0	8	1.8-3.0
Remanent Polarization	P_r	$\mu\text{Coul/cm}^2$	39.0	39	
Coupling Coefficients	k_p		0.65	0.75	
	k_{33}		0.72	0.75	0.91
	k_{31}		0.36	0.43	0.44
	k_t		0.48	0.55	0.60
	k_{15}		0.59	0.75	0.35
Piezoelectric Charge (Displacement) Coefficient	d_{31}	Coul/N x 10 ⁻¹² (or) m/V x 10 ⁻¹²	-190	-320	-699
	d_{33}		390	650	1540
Piezoelectric Voltage Coefficient	g_{33}	V-m/N x 10 ⁻³	24.0	19.0	32.2
	g_{31}		-11.3	-9.5	-14.6
Elastic Modulus	Y_{11}^E	N/m ² x 10 ¹⁰	6.7	6.3	1.9
	Y_{33}^E		5.3	5.0	1.7
Resonant Thickness	N_{tr}	KHz-cm	211	202	200
Anti-Resonant Thickness	N_{ta}	KHz-cm	236	236	
Thermal Expansion (⊥ to Poling)	α	ppm/°C	3.0	3.5	
Specific Heat	C_p	J/kg-°C	440	420	330
Thermal Conductivity	K_d	W/m-°K	1.2	1.2	1.336
Poisson's Ratio	ν		0.31	0.31	0.37

Midé's standard products typically use PZT 5H due to improved performance over PZT 5A at a comparable price. The performance of PZT 5A is more stable over temperature however. PMN-PT exhibits the best piezoelectric properties but this comes with a much higher cost. Midé offers three products (PPA-1031, PPA-1032, and PPA-1033) that have the same form factor but with these three different piezoelectric materials (PZT 5A, PZT 5H, and PMN-PT) for "apples to apples" comparison between these materials.

piezoelectric information and equations. A good reference Midé typically uses is from [Morgan Advanced Materials](#).

There are a number of online resources that provide additional

5.2 PACKAGING MATERIALS

Properties	Units	FR4	Copper	Polyimide	304 Steel	Polysulfone	Polyester
Young's Modulus	GPa	26	110	4.1	193	5.72	3.65
Poisson's ratio		0.172	0.343	0.34	0.29	0.4	0.48
Density	g/cc	1.9	8.93	1.41	8	1.37	1.38
Ultimate Tensile Strength	MPa	368	210	231	505	87	177
Tensile Yield Strength	MPa	340	33.3	90	215	87.9	92.8
Thermal Expansion Coefficient	$\mu\text{m/m-C}$	15	16.4	34.3	17.3	31	17
Thermal Conductivity	W/m-K	0.4	398	0.26	16.2	0.26	0.15
Specific Heat	J/g-C	0.6	0.385	1.09	0.5	910	1.17
Maximum Operating Temperature	C	130	1083	275	1400	160	220

There are thin layers of epoxy between each material; but for modeling purposes this layer can be ignored (<0.02 mm thick). The operating temperature range for Midé's PPA products is -40 to 120 C due to the epoxy used. Higher temperature, up to 150 C, is available with alternative epoxy (see Midé's Piezo Flo products). See Section 7 for custom solutions.

TESTING METHODS

Detailed explanation on how the experimental data was gathered which was used to generate all presented performance data.

6.1 ENERGY HARVESTING

Energy harvesting calculations were performed for each piezoelectric product using the simple electric power equation $P = VI$, where V is the voltage generated by the piezo and I is the load current through the circuit. In order to measure these electric parameters in a vibration environment, a simple experimental setup using a close-looped electromagnetic shaker, a variable potentiometer and two digital multimeters were used to determine the overall power of each piezo at various acceleration values (0.25, 0.5, 1.0 and 2.0 g).

The piezo is loaded into the product harness with the clamping bars in the middle clamp location. Using a custom interface piece, the product harness was then mounted to the shaker such that the piezo would deflect in the same direction as the shaker vibrates (i.e. vertically towards the ceiling/floor). First and foremost, the piezo terminals were hooked up to a multimeter and RMS open-circuit voltage was measured at each g level tested. The shaker swept through dwells of various frequencies until the resonance frequency of the piezo at each g level was obtained. This frequency was then used for each product. This was repeated for various amounts of tip mass (i.e. none, full, and mass that generated a 60 Hz resonance). After obtaining resonance frequency, the circuit was adjusted to measure RMS current in order to obtain power.

From one of the piezo terminals, a multimeter was connected in series with one leg of the potentiometer in order to measure RMS current. The other leg of the potentiometer was connected to the second piezo terminal by means of another electrical lead. The second multimeter was connected to both legs of the potentiometer to measure the RMS voltage across the potentiometer. The shaker was run again at resonance frequency while current and voltage were measured by the multimeters. The potentiometer resistance was changed while the shaker vibrated in order to determine the load resistance that generated maximum power. The resistance value was then calculated using Ohm's Law. See Figure 82 for an example on how load affects the power output from the piezo.

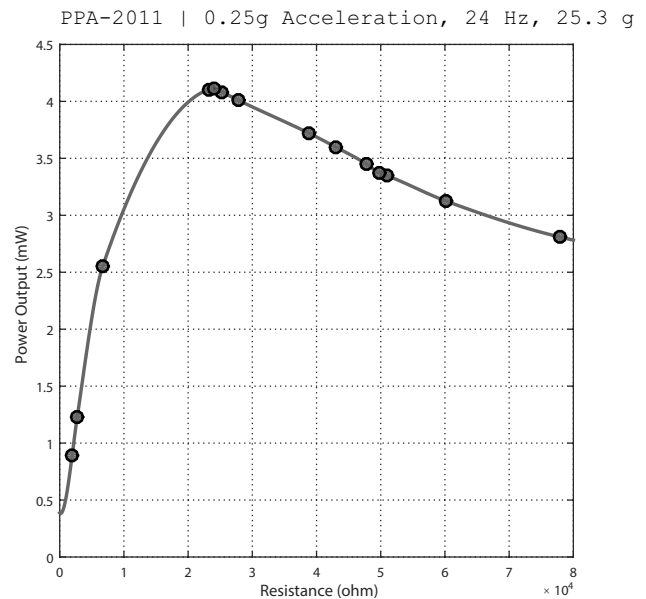

Figure 82: The power output of a piezo energy harvester can be optimized by adjusting the resistance/current/voltage as shown for testing on one of the products. The optimal resistance level is included for each test condition on all products.

This test was performed for all products in the middle clamp location, at 0.25, 0.5, 1, & 2 g accelerations for no tip mass, full tip mass, and a 60 Hz resonance tip mass. The peak to peak displacement of the piezo for each test was also measured by a laser sensor to determine the mechanical displacement experienced at each g level with varying tip masses. This allows for greater insight to the strain experienced by the piezo.

6.2 STATIC DEFLECTION/BLOCK FORCE

At very low frequencies piezo products experience quasi-static deformations that can be used in actuator applications. In order to measure the performance of each piezo as a quasi-static actuator, each piezo was powered at 100V and fed a 0.1 and 1 Hz frequency to measure the block force and quasi-static deflection, respectively, of each piezo. With these measurements a range of static actuator applications applicable to each product can be determined. This test was repeated for all three clamp locations on the piezo mounting harness.

With a function generator hooked up to an amplifier to drive 100 V (rms = 71V) into each piezo, the free tip of each piezo was placed directly over top of a compression load cell operating at

15 V with signal wires connected to a multimeter. With a small frequency (0.1 Hz) applied by the function generator, the piezo would press on the load cell resulting in a voltage readout from the multimeter. This voltage was recorded as the force applied by the piezo and was then converted into mechanical force (N, oz.)

Each product was clamped in a mounting harness and then fixed to an XY table for positioning underneath a displacement measuring laser. The laser focal point was placed on a corner of the free tip on the piezo for maximum deflection measurement. The piezo was driven at 1 Hz at 100 V. An oscilloscope was used to read the deflection as a sinusoidal voltage wave, which was then converted to linear displacement ($8 \times V [V] = d [mm]$).

6.3 FREQUENCY SWEEP

In order to determine the functionality of each product as an actuator, a sweep of electrical signals at various frequencies was applied to each product at 100V (determined as the upper threshold for safe operating voltage). The mechanical deflection and current draws at each frequency were recorded. These recordings identify the performance output and natural frequency of each product. The test was repeated for all three clamp locations with and without the tip mass end loaded.

A function generator was hooked up to an amplifier in order to supply a steady 100V (RMS = 71V), as well as to allow a wide range of frequencies to be signaled through the leads of the piezos. With a multimeter in series, AC draw (mA) from each piezos was measured at frequencies ranging between 10 – 800 Hz.

Each product was clamped in the PPA-5001 Clamp Base (more information in Section 4.1) and then fixed to an XY table for positioning underneath a displacement measuring laser. The laser focal point was placed on a corner of the free tip on the piezo for maximum deflection measurement. An oscilloscope was used to read the deflection as a sinusoidal voltage wave and then be converted to linear displacement.

6.4 SENSITIVITY/POWER BANDWIDTH

The sensitivity testing was run to understand how each piezo would behave when put in a sensor application, such as an accelerometer. Sensitivity (V/g) was determined by exposing each piezo to 2g acceleration at frequencies between 10 & 1000 Hz and had its open-circuit voltage measured at each frequency.

An electromagnetic shaker was programmed to run a frequency sweep at 2g acceleration with 10 second dwells events at each of the frequencies chosen for testing. This allowed a constant acceleration and sweep of frequencies to be applied to each piezo while still being able to measure the output voltage of each product.

Each piezo was clamped and bolted down to a mounting fixture along the axis of vibration of the shaker. The terminals of each piezo were connected to a multimeter for measurement and had voltage measured from it across the sweep, at resonance frequency and at the two frequencies representing the upper and lower bounds of the half power bandwidth. The data from the sweep was analyzed and a range experiencing nearly constant sensitivity was determined (starting at 13 Hz and ending at the frequency that exceeded +3dB from the nominal sensitivity).

CUSTOM SOLUTIONS

Midé prides itself on its ability to solve tough engineering problems in an efficient and cost effective manner. Custom piezo packages can be designed and built by Midé similar to the examples shown below. Midé can use different packaging materials, different piezoelectric materials, different epoxy etc. The form factor can also be modified with varying configurations of mounting holes/features, connectors etc. Please note that custom solutions involve an NRE of between \$2K and \$10K depending on the complexity. Midé recommends a thorough feasibility analysis using the standard products prior to any NRE.

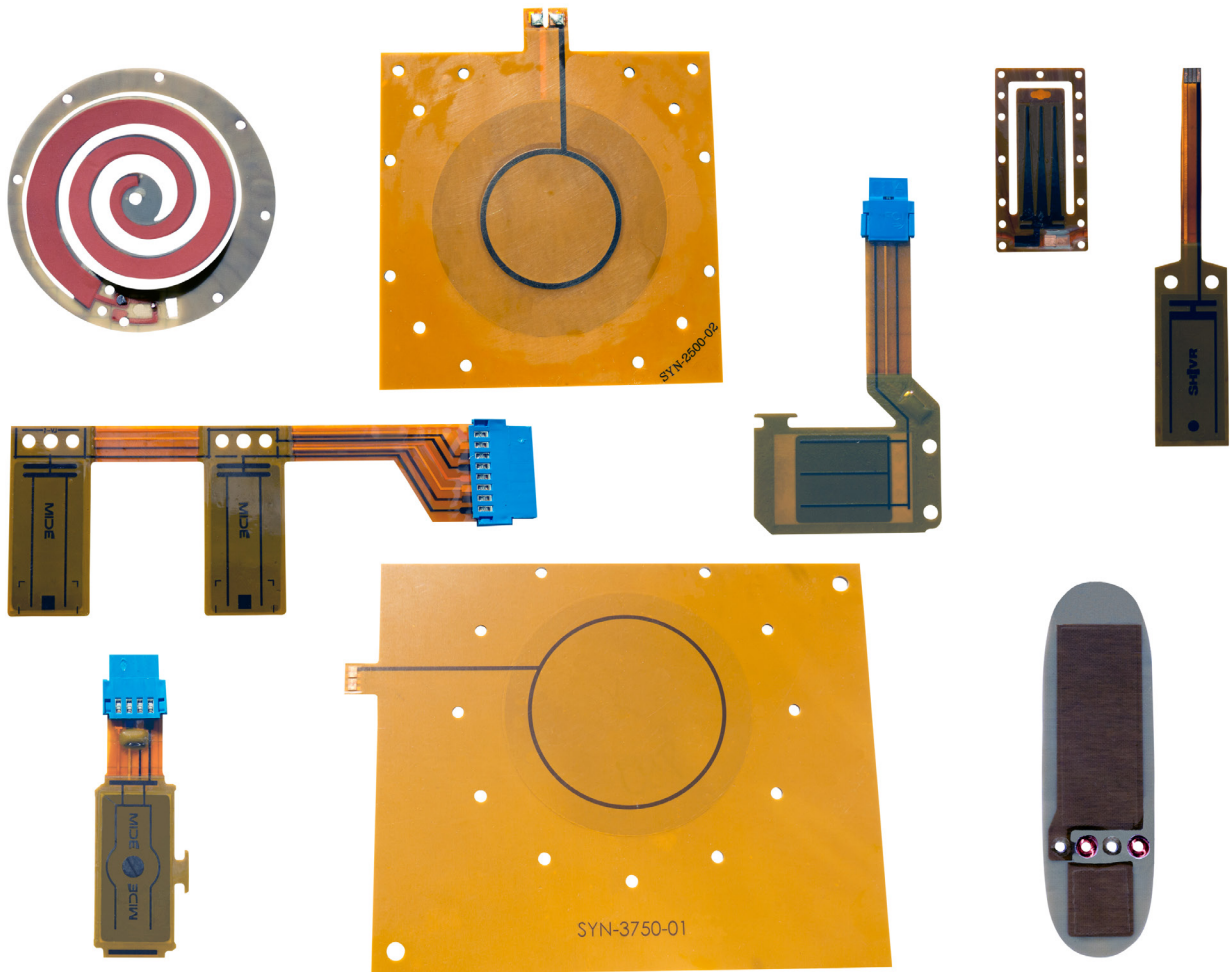

8.0 TROUBLESHOOTING

Problem	Potential Cause	Action
No Power Output or Electric Output for Sensing	The piezo is not properly connected.	Ensure that the two copper pads on the piezo product are properly connected. This is most reliably done if you check the capacitance.
	The piezo is not tuned to the frequency of the vibrating source.	Tune the piezo by changing the clamp location and/or adding tip mass as detailed in Section 4.
	The vibration environment is not sufficient.	Power output will be very low when trying to harvest from shock/impulse events (see FAQs), these products perform better for continued vibration. Measure the amplitude of this vibration with one of Midé's Slam Stick products and use the Volture product selector to ensure that the power output is adequate.
No Motion When Driven	The piezo is not properly connected.	Ensure that the two copper pads on the piezo product are properly connected. This is most reliably done if you check the capacitance.
	The piezo is not tuned to the frequency of the vibrating source.	Tune the piezo by changing the clamp location and/or adding tip mass as detailed in Section 4.
	The drive voltage may be too low	Check the drive voltage to ensure it is properly amplified. Piezos need close to 100 volts to move an adequate amount.

8.1 FREQUENTLY ASKED QUESTIONS

1. How does a piezoelectric actuator create motion and/or create an electric signal?

Some materials exhibit what is called the piezoelectric effect, which literally means that electric charge is generated when the material is pressed (or squeezed or stretched). The reverse is also true: an applied electric field will cause a change in dimensions of the piece of material. For a positive voltage applied in the z-direction, a solid rectangular piece will expand in one direction (z) and contract in the other two (x and y); if the voltage is reversed, the piece will contract in the z-direction and expand in the x- and y-directions. This is somewhat like thermal expansion and contraction, but since electric field is used instead of temperature, a quick reaction is achieved in response to commands easily generated with electronic circuits.

2. How do I tune my piezo?

A "tuned" beam means that the natural frequency of your piezo matches the frequency of the environment its harvesting energy from or the drive signal you are exciting the piezo with. A tuned piezo will drastically outperform an untuned one in both energy

harvesting and actuation applications. Tuning your piezo beam is achieved by adjusting the clamp position and/or the tip mass. Adding tip mass will reduce the resonant frequency. Lengthening the beam by moving the clamp location will also reduce the resonance. The opposite is true for both as well. See Section 4.3 for more information. To test what the resonance of your piezo pack is, simply connect the piezo terminals to an oscilloscope. If the piezo is "flicked" it will vibrate at its resonant/natural frequency.

3. I'd like to model the performance of the piezo in software. How can I do that?

The relevant material properties are included in Section 5 for modeling and simulation of our piezos. Refer to a particular product's specifications to determine the geometry necessary for modeling. Layer thickness is also provided. Simple simulations and calculations can be made in MATLAB or a similar analysis software. More complex 3D analysis will likely need a Finite Element Analysis software package for piezoelectrics such as ANSYS, COMSOL, or others. Midé has used SolidWorks Simulation and NASTRAN to model piezos by manipulating the thermal expansion coefficient of the material. This works well but has its limitations in regard to poling direction.

4. How much current is required to drive a piezo actuator?

For many purposes, the electrical behavior of an actuator can be approximated by that of a simple capacitor. When the actuator is driven with a sinusoidal voltage, the required current can be found from the equation: $I = (2\pi f)CV$ where I is peak current in amperes, C is capacitance in farads, V is peak drive voltage and f is frequency in hertz. The capacitance of each product is listed. Note that at resonance the current draw can be as much as 20% to 50% higher depending on the configuration.

For static/DC actuation the current draw is very low. The current draw can be calculated from the following equation: $I = C \, dV/dt$ where I is peak current in amperes, C is capacitance in farads, dV/dt is rate of change of the voltage (V/s). To hold the position, once actuated, the piezo draws very little current. The only current draw needed is to compensate for the very low leakage currents, even in the case of very high loads. This is true even when suddenly disconnected from the electrical source, the charged piezo will slowly discharge the electrical energy and return to the zero position slowly.

5. What is the frequency range the piezo can operate in?

Each product must be tuned to a specific frequency for optimal energy harvesting and for the most significant displacement and force output during actuation. This resonant frequency can be adjusted by changing the clamp location and/or changing how much tip mass is on the beam. Each of the products have a wide range of resonant frequencies from as low as 20 Hz up to 500 Hz. But all of these will operate at virtually any frequency in actuation. In energy harvesting it will need at least 2 Hz of motion to produce any electrical current; but it is virtually unlimited in regard to higher frequencies.

6. How much power output can I expect?

Midé created an easy to use product selector that, if provided a vibration frequency and amplitude (refer to Section 4.3.3), it calculates the expected power output, tip mass required, open circuit voltage, and peak to peak displacement. These calculated values are meant to only act as a guide in selecting your product and determining feasibility. All of these parameters are impacted by manufacturing tolerances, clamping, temperature, even the load applied to the power output. Once an estimate has been calculated, accurate data can only be confirmed with testing in the desired environment.

7. Can my piezo energy harvester harvest energy from shock/impact events?

Yes, when a piezo beam is excited with a shock or impact event the beam will oscillate at its own resonant frequency but quickly (depends on the resonance but within about 2 seconds) dampen out. Midé recommends directly testing the power output for your given environment and clamp conditions but you can expect as much as 0.5 mJ of energy to be harvested from a single impact event if optimal conditions are met. The following figure provides a typical output from a shock event. One will notice that the initial output is quite large; but it quickly dampens out within a second or two. This dampening coefficient will depend on the harvester, tip mass, and clamp configuration.

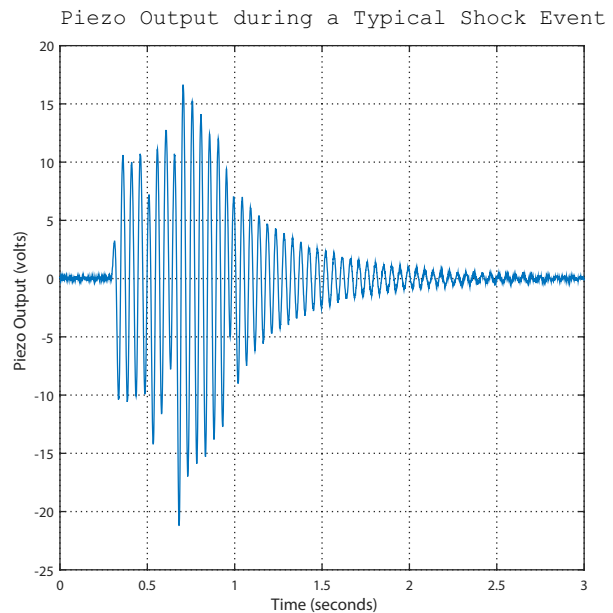

8. Can my piezo energy harvester charge a phone or battery?

Yes, but over a very long period of time. These harvesters will generate at most a few mA of current on the order of 10s of volts. For easy math, we'll assume the harvester generates 5 mA at 20 volts, or 100 mW of continuous power. Most phones have about 2,500 mAh of storage capacity, similar to a AA battery. Assuming the phone or battery is operating at 5 volts, it will take 125 hours (over 5 days) to fully charge the battery or phone. Alternatively, you will need 125 piezo energy harvesters to charge this battery in one hour. Now these numbers used were very aggressive, where most applications only have a few milliwatts of power available. In these applications it will take several thousand hours to charge the device or battery. Piezo energy harvesters are better suited for applications that require very little energy such as periodic measurements in health monitoring applications for example.

They are not well suited for charging large batteries.

9. What is the “Half Power Bandwidth” and the “Q Factor?”

The half power bandwidth defines the frequency range at which the output/displacement is greater than -3 dB or greater than the maximum output/displacement divided by root 2. The Q factor is the ratio of the resonant frequency to the half power bandwidth. The higher the Q factor, the narrower and sharper the peak is.

10. What happened to the older QuickPack and Vulture products?

These first generation products were discontinued and replaced by the new PPA line. The PPA line improved upon performance, cost, and ease of use over the older products. Midé can still manufacture these products but this would involve a custom order as the materials are not stocked any longer. Therefore, the minimum order size would need to be on the order of \$5,000 with a 3 month lead time.

11. How can I drive/power my piezo actuator?

Midé is developing a piezo driver that incorporates the waveform generation and voltage amplifier in one easy-to-use package. Until that product is finalized you must use a signal generator and amplifier. Midé has used amplifiers from <http://piezodrive.com/> in the past before that are easy to use and cost effective.

Also, Texas Instruments offers several COTS piezo driver/boost amplifier chips that can be used for embedded designs. Here is a brief list:

Chip	Application	Evaluation Module
DRV8662	Haptic Piezo Driver (Analog Front End)	http://www.ti.com/tool/drv8662evm
DRV2665	Haptic Piezo Driver (Digital Front End)	NA
DRV2667	Haptic Piezo Driver (Digital Front End, with Waveform storage)	http://www.ti.com/tool/drv2667evm-ct
DRV2700	Industrial, General Purpose Piezo Driver	http://www.ti.com/tool/drv2700evm

LM48560	Piezo Speaker Driver	http://www.ti.com/tool/lm48560tleval
LM48580	Piezo Speaker/ Low Voltage Haptic Piezo Driver	NA

12. What conditioning electronics do I need to use the piezo energy harvester?

The piezo’s output will be a relatively high voltage, low current AC signal that needs to be conditioned for use with most other electronics. Midé has partnered with Linear Technology who offers a number of commercially available chips and demonstration boards for energy harvesting applications. The following solutions are recommended:

- [LTC3588-1](#) – Nanopower Energy Harvesting Power Supply
- [Demo board](#) from Linear Technology
- [Breakout board](#) from Spark Fun
- [DC2042A](#) – Energy Harvesting Multi-Source Demo board
- [LTC3588-2](#) – Nanopower Energy Harvesting Power Supply (higher voltage)
- [LTC3330](#) –Nanopower Buck-Boost DC/DC with Energy Harvesting Battery Life Extender
- [Demo board](#) from Linear Technology
- [LTC3331](#) – Nanopower Buck-Boost DC/DC with Energy Harvesting Battery Charger
- [Demo board](#) from Linear Technology

13. I am using your products for educational purposes, is there any educational discount available?

Midé does not offer an educational discount. The PPA-1001 is the most cost effective product we offer and we recommend this

for those on a tight budget.

13. What do the numbers mean on the PPA products?

These numbers represent serial numbers within a manufacturing lot. They are there for traceability and have no impact on the performance of the product.

8.2 PRODUCT SUPPORT

For technical support, repair, and returns please contact through its online contact form at <http://www.mide.com/mide/contact.php>

Please note that product specifications are subject to change without notice. This often occurs due to Midé's continued effort to improve the features and functionality of this product. For up-to-date documentation and other product information please visit our website at www.mide.com. Midé's sales and technical staff would also be happy to help with any inquires of updated product information.

Midé 200 Boston Avenue, Suite 1000, Medford MA, 02155.

Midé Technology is an ISO 9001:2008 Certified Company.