

CZRW55C2V4-G Thru CZRW55C39-G

Voltage: 2.4 to 39 Volts

Power: 500 mWatts

RoHS Device

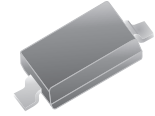

Features

- Planar die construction.
- 500mW power dissipation.
- Ideally suited for automated assembly process.
- Ultra small surface mount package.

Mechanical data

- Case: SOD-123, Molded plastic
- Terminals: Solderable per MIL-STD-202G, method 208
- Polarity: Indicated by cathode band.
- Mounting position: Any

Marking: see table on page2

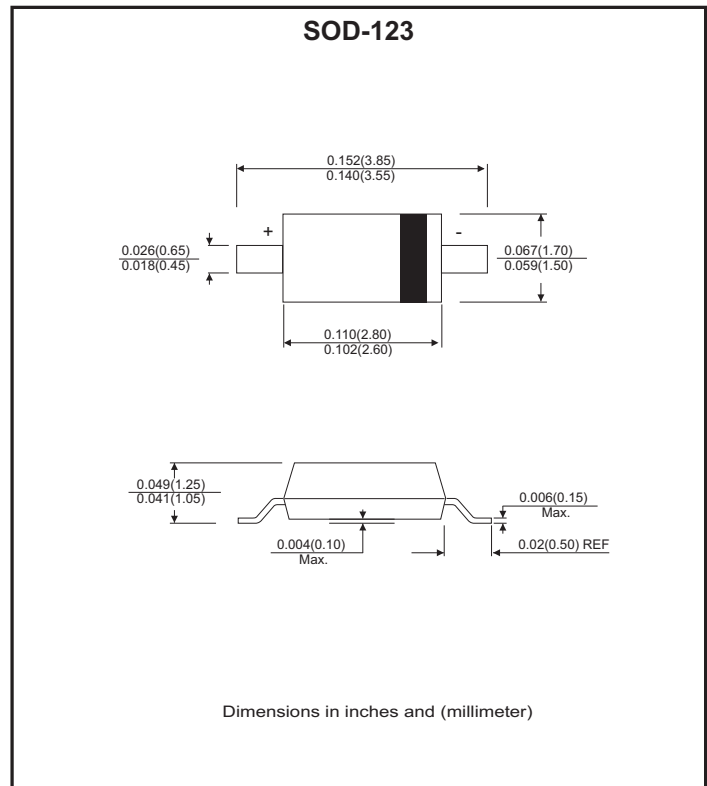

Maximum Ratings (TA=25°C, unless otherwise specified)

| Parameter | Symbol | Value | Unit |
|--|-----------------------------------|-------------|------|
| Forward voltage at IF=10mA (Note 2) | V _F | 0.9 | V |
| Power dissipation (Note 1) | P _D | 500 | mW |
| Thermal resistance, junction to ambient air | R _{θJA} | 250 | °C/W |
| Operating junction and storage temperature range | T _J , T _{STG} | -65 to +150 | °C |

Note:

1. Device mounted on ceramic PCB: 7.6mm×9.4mm×0.87mm with pad area 25mm²
2. Short duration test pulse used to minimize self-heating effect.
3. When provided, otherwise, parts are provided with date code only, and type number identifications appears on reel only.
4. f=1KHz

Electrical Characteristics(Ta = 25°C)

| Part No. | Nom in al Zener Voltage | | | Max. Zener Impedence | | | | Max. Reverse Leakage Current | | Temperature Coefficient of Zener Voltage @IZT=5mA (mV/°C) | | Marking Code |
|--------------|-------------------------|-------|-------|----------------------|-----|-----------|------|------------------------------|------|---|------|--------------|
| | VZ @ IZT | | | ZZT @ IZT | | ZZK @ IZK | | IR @ VR | | Min. | Max. | |
| | Nom. | Min. | Max. | ohm | mA | ohm | mA | uA | V | | | |
| CZRW55C2V4-G | 2.4 | 2.20 | 2.60 | 100 | 5.0 | 600 | 1.00 | 50.0 | 1.0 | -3.5 | 0.0 | WX |
| CZRW55C2V7-G | 2.7 | 2.50 | 2.90 | 100 | 5.0 | 600 | 1.00 | 20.0 | 1.0 | -3.5 | 0.0 | W1 |
| CZRW55C3V0-G | 3.0 | 2.80 | 3.20 | 95 | 5.0 | 600 | 1.00 | 10.0 | 1.0 | -3.5 | 0.0 | W2 |
| CZRW55C3V3-G | 3.3 | 3.10 | 3.50 | 95 | 5.0 | 600 | 1.00 | 5.0 | 1.0 | -3.5 | 0.0 | W3 |
| CZRW55C3V6-G | 3.6 | 3.40 | 3.80 | 90 | 5.0 | 600 | 1.00 | 5.0 | 1.0 | -3.5 | 0.0 | W4 |
| CZRW55C3V9-G | 3.9 | 3.70 | 4.10 | 90 | 5.0 | 600 | 1.00 | 3.0 | 1.0 | -3.5 | 0.0 | W5 |
| CZRW55C4V3-G | 4.3 | 4.00 | 4.60 | 90 | 5.0 | 600 | 1.00 | 3.0 | 1.0 | -3.5 | 0.0 | W6 |
| CZRW55C4V7-G | 4.7 | 4.40 | 5.00 | 80 | 5.0 | 500 | 1.00 | 3.0 | 2.0 | -3.5 | 0.2 | W7 |
| CZRW55C5V1-G | 5.1 | 4.80 | 5.40 | 60 | 5.0 | 480 | 1.00 | 2.0 | 2.0 | -2.7 | 1.2 | W8 |
| CZRW55C5V6-G | 5.6 | 5.20 | 6.00 | 40 | 5.0 | 400 | 1.00 | 1.0 | 2.0 | -2.0 | 2.5 | W9 |
| CZRW55C6V2-G | 6.2 | 5.80 | 6.60 | 10 | 5.0 | 150 | 1.00 | 3.0 | 4.0 | 0.4 | 3.7 | WA |
| CZRW55C6V8-G | 6.8 | 6.40 | 7.20 | 15 | 5.0 | 80 | 1.00 | 2.0 | 4.0 | 1.2 | 4.5 | WB |
| CZRW55C7V5-G | 7.5 | 7.00 | 7.90 | 15 | 5.0 | 80 | 1.00 | 1.0 | 5.0 | 2.5 | 5.3 | WC |
| CZRW55C8V2-G | 8.2 | 7.70 | 8.70 | 15 | 5.0 | 80 | 1.00 | 0.7 | 5.0 | 3.2 | 6.2 | WD |
| CZRW55C9V1-G | 9.1 | 8.50 | 9.60 | 15 | 5.0 | 100 | 1.00 | 0.5 | 6.0 | 3.8 | 7.0 | WE |
| CZRW55C10-G | 10.0 | 9.40 | 10.60 | 20 | 5.0 | 150 | 1.00 | 0.2 | 7.0 | 4.5 | 8.0 | WF |
| CZRW55C11-G | 11.0 | 10.40 | 11.60 | 20 | 5.0 | 150 | 1.00 | 0.1 | 8.0 | 5.4 | 9.0 | WG |
| CZRW55C12-G | 12.0 | 11.40 | 12.70 | 25 | 5.0 | 150 | 1.00 | 0.1 | 8.0 | 6.0 | 10.0 | WH |
| CZRW55C13-G | 13.0 | 12.40 | 14.10 | 30 | 5.0 | 170 | 1.00 | 0.1 | 8.0 | 7.0 | 11.0 | WI |
| CZRW55C15-G | 15.0 | 13.80 | 15.60 | 30 | 5.0 | 200 | 1.00 | 0.1 | 10.5 | 9.2 | 13.0 | WJ |
| CZRW55C16-G | 16.0 | 15.30 | 17.10 | 40 | 5.0 | 200 | 1.00 | 0.1 | 11.2 | 10.4 | 14.0 | WK |
| CZRW55C18-G | 18.0 | 16.80 | 19.10 | 45 | 5.0 | 225 | 1.00 | 0.1 | 12.6 | 12.4 | 16.0 | WL |
| CZRW55C20-G | 20.0 | 18.80 | 21.20 | 55 | 5.0 | 225 | 1.00 | 0.1 | 14.0 | 14.4 | 18.0 | WM |
| CZRW55C22-G | 22.0 | 20.80 | 23.30 | 55 | 5.0 | 250 | 1.00 | 0.1 | 15.4 | 16.4 | 20.0 | WN |
| CZRW55C24-G | 24.0 | 22.80 | 25.60 | 70 | 5.0 | 250 | 1.00 | 0.1 | 16.8 | 18.4 | 22.0 | WO |
| CZRW55C27-G | 27.0 | 25.10 | 28.90 | 80 | 2.0 | 300 | 0.50 | 0.1 | 18.9 | 21.4 | 25.3 | WP |
| CZRW55C30-G | 30.0 | 28.00 | 32.00 | 80 | 2.0 | 300 | 0.50 | 0.1 | 21.0 | 24.4 | 29.4 | WQ |
| CZRW55C33-G | 33.0 | 31.00 | 35.00 | 80 | 2.0 | 325 | 0.50 | 0.1 | 23.1 | 27.4 | 33.4 | WR |
| CZRW55C36-G | 36.0 | 34.00 | 38.00 | 90 | 2.0 | 350 | 0.50 | 0.1 | 25.2 | 30.4 | 37.4 | WS |
| CZRW55C39-G | 39.0 | 37.00 | 41.00 | 130 | 2.0 | 350 | 0.50 | 0.1 | 27.3 | 33.4 | 41.2 | WT |

Ratings and Characteristic Curves(CZRW55C2V4-G Thru. CZRW55C39-G)

Fig.1 Power Dissipation Derating Curve

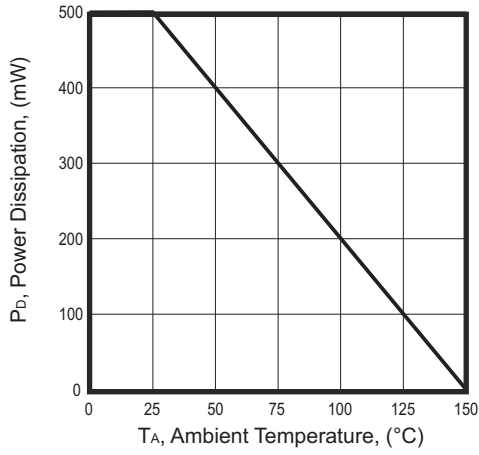

Fig.2 Zener Breakdown Characteristics

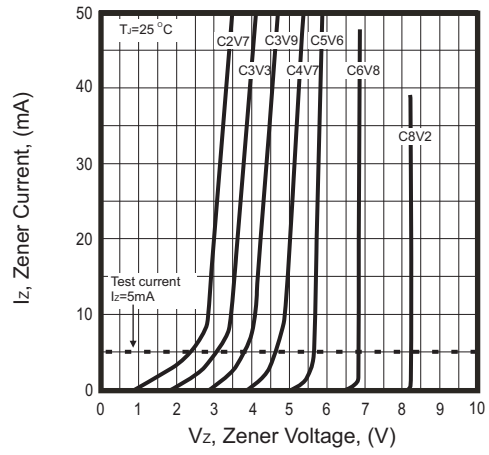

Fig.3 Zener Breakdown Characteristics

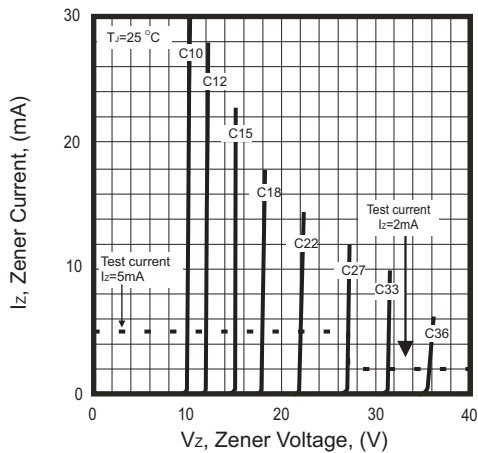

Fig.4 Zener Breakdown Characteristics

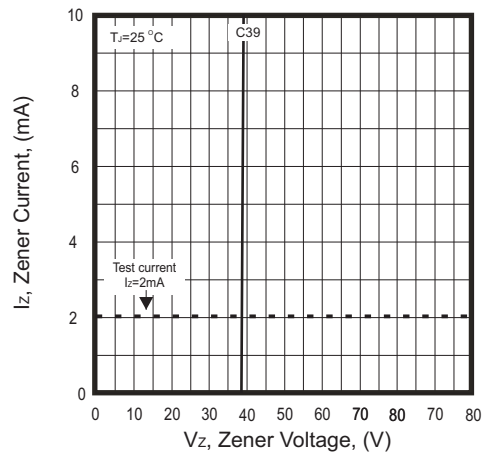
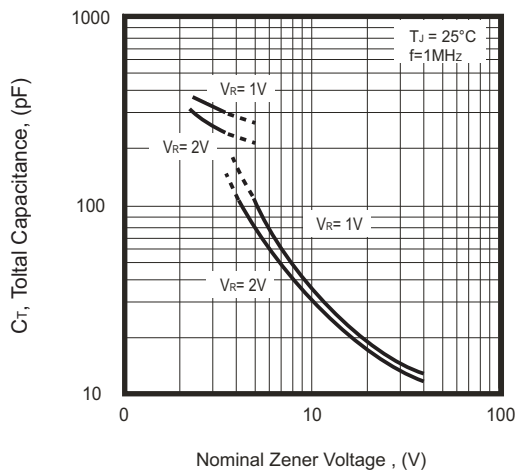
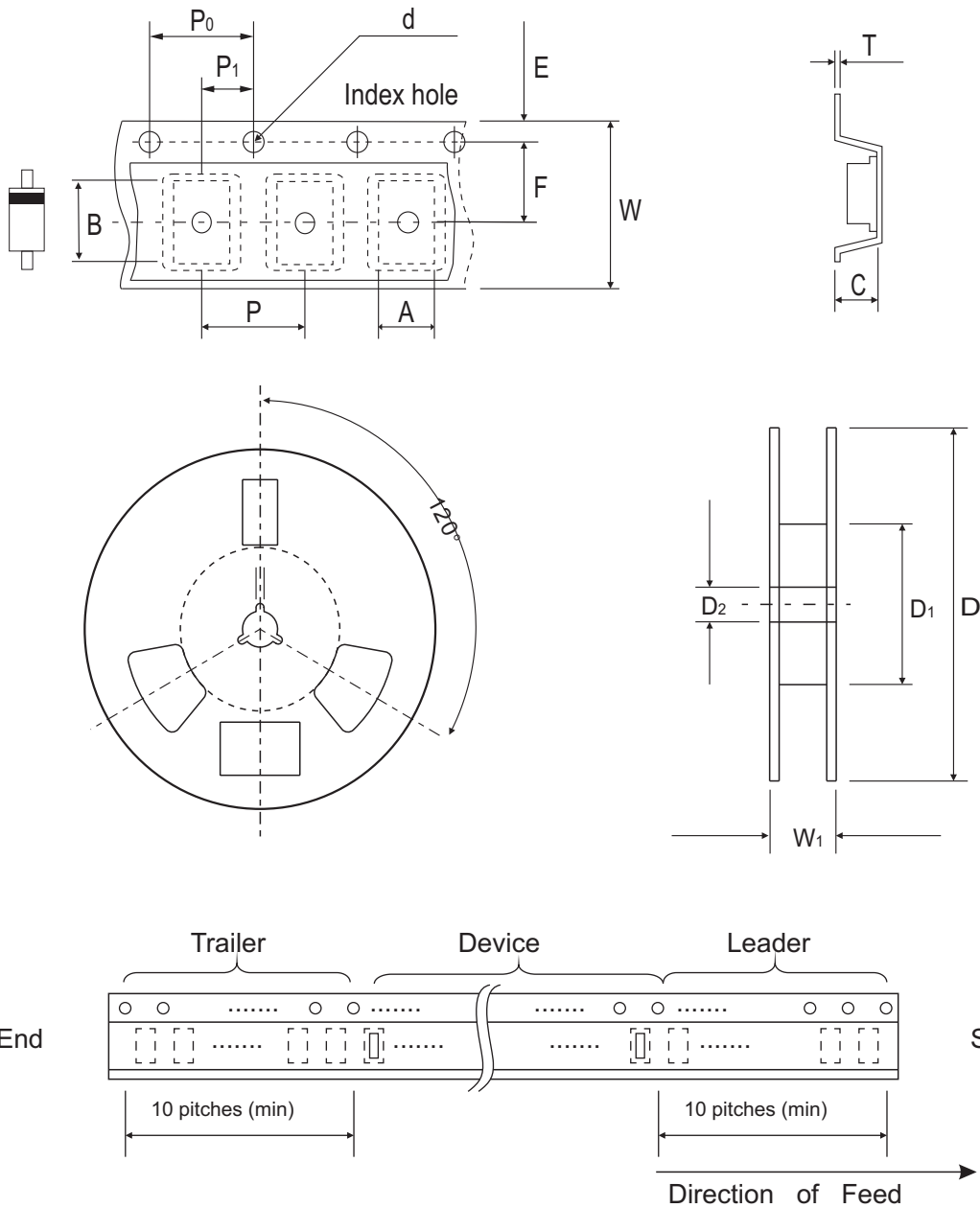

Fig.4- Total Capacitance vs Nominal Zener Voltage



Reel Taping Specification



| SOD-123 | SYMBOL | A | B | C | d | D | D1 | D2 |
|---------|--------|---------------|---------------|---------------|---------------|---------------|---------------|---------------|
| | (mm) | 1.85 ± 0.10 | 3.94 ± 0.10 | 1.57 ± 0.10 | 1.55 ± 0.10 | 178 ± 1.00 | 54.40 ± 0.40 | 13.0 ± 0.20 |
| | (inch) | 0.073 ± 0.004 | 0.155 ± 0.004 | 0.062 ± 0.004 | 0.061 ± 0.004 | 7.008 ± 0.039 | 2.142 ± 0.016 | 0.512 ± 0.008 |

| SOD-123 | SYMBOL | E | F | P | P0 | P1 | W | W1 |
|---------|--------|---------------|---------------|---------------|---------------|---------------|-------------------------|---------------|
| | (mm) | 1.75 ± 0.10 | 3.50 ± 0.05 | 4.00 ± 0.10 | 4.00 ± 0.10 | 2.00 ± 0.10 | 8.00 + 0.30 / - 0.10 | 9.50 ± 1.00 |
| | (inch) | 0.069 ± 0.004 | 0.138 ± 0.002 | 0.158 ± 0.004 | 0.158 ± 0.004 | 0.079 ± 0.004 | 0.315 + 0.011 / - 0.004 | 0.374 ± 0.039 |

Marking Code

| Part Number | Marking Code |
|-------------------------------|--------------|
| CZRW55C2V4-G Thru CZRW55C39-G | XX |



Suggested PAD Layout

| SIZE | SOD-123 | |
|------|---------|--------|
| | (mm) | (inch) |
| A | 3.35 | 0.132 |
| B | 0.80 | 0.032 |
| C | 1.00 | 0.039 |
| D | 4.15 | 0.163 |
| E | 2.55 | 0.100 |

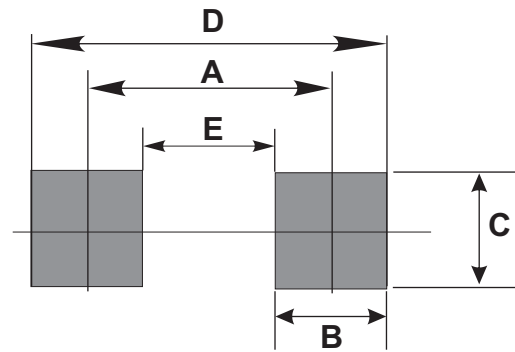

Standard Packaging

| Case Type | REEL PACK | |
|-----------|--------------|------------------|
| | REEL (pcs) | Reel Size (inch) |
| SOD-123 | 3,000 | 7 |