

Middle Power LED Series
2835 1.0W 9V Ra90 Hot bin

LM283B+



Designed for better lm/\$ (Lamps)

Features & Benefits

- 0.9W Class mid power LED
- Standard form factor for design flexibility (2.8 × 3.5 × 0.65mm)



Table of Contents

| | | | |
|-----|-------------------------------------|-------|----|
| 1. | Characteristics | ----- | 3 |
| 2. | Product Code Information | ----- | 6 |
| 3. | Typical Characteristics Graphs | ----- | 16 |
| 4. | Outline Drawing & Dimension | ----- | 19 |
| 5. | Reliability Test Items & Conditions | ----- | 20 |
| 6. | Soldering Conditions | ----- | 21 |
| 7. | Tape & Reel | ----- | 22 |
| 8. | Label Structure | ----- | 25 |
| 9. | Packing Structure | ----- | 26 |
| 10. | Precautions in Handling & Use | ----- | 30 |

1. Characteristics

a) Absolute Maximum Rating

| Item | Symbol | Rating | Unit | Condition |
|---------------------------------|-----------|------------|---------|-----------------------------|
| Ambient / Operating Temperature | T_a | -40 ~ +85 | °C | - |
| Storage Temperature | T_{stg} | -40 ~ +85 | °C | - |
| LED Junction Temperature | T_j | 125 | °C | - |
| Forward Current | I_F | 110 | mA | - |
| Peak Pulsed Forward Current | I_{FP} | 200 | mA | Duty 1/10, pulse width 10ms |
| Assembly Process Temperature | - | 260 <10 | °C s | - |
| ESD (HBM) | - | 2 | kV | - |

Note:

Proper current derating must be observed to maintain junction temperature below the maximum at all time.

b) Electro-optical Characteristics ($I_F = 100 \text{ mA}$, $T_s = 25 \text{ }^\circ\text{C}$)

| Item | Unit | Rank | Bin | Min. | Typ. | Max. |
|--|--------------------|----------------|-----|------|------|------|
| Forward Voltage (VF) | V | SG or SK | GZ | 8.8 | - | 9.1 |
| | | | G1 | 9.1 | - | 9.4 |
| | | | G2 | 9.4 | - | 9.7 |
| | | | G3 | 9.7 | - | 10.0 |
| Color Rendering Index (Ra) | - | 7 | | 90 | - | - |
| Special CRI (R9) | - | - | | 50 | | |
| Thermal Resistance (junction to solder point) | $^\circ\text{C/W}$ | | | - | 15 | - |
| Beam Angle | $^\circ$ | | | - | 120 | - |

Note:

Samsung maintains measurement tolerance of: forward voltage = $\pm 0.1 \text{ V}$, CRI = ± 3 , R9 = ± 6.5

b) Electro-optical Characteristics (I_F = 100 mA, T_s = 25 °C)

| Item | CRI (R _a) Min. | Nominal CCT (K) | Bin | 100mA | |
|---------------------------------|-------------------------------|--------------------|-----|-------|------|
| | | | | Min. | Max. |
| Luminous Flux (Φ _v) | 90 | 2700 | SA | 88 | 94 |
| | | | SB | 94 | 104 |
| | | 3000 | SA | 91 | 98 |
| | | | SB | 98 | 108 |
| | | 3500 | SA | 93 | 100 |
| | | | SB | 100 | 110 |
| | | 4000 | SA | 96 | 103 |
| | | | SB | 103 | 113 |
| | | 5000 | SA | 98 | 105 |
| | | | SB | 105 | 115 |
| | | 5700 | SA | 97 | 104 |
| | | | SB | 104 | 114 |
| | | 6500 | SA | 96 | 103 |
| | | | SB | 103 | 113 |

Note:

Samsung maintains measurement tolerance of: forward voltage = ±0.1V, luminous flux = ±5 %, CRI = ±3

2. Product Code Information

| | | | | | | | | | | | | | | | | | |
|---|---|---|---|---|---|---|---|---|----|----|----|----|----|----|----|----|----|
| 1 | 2 | 3 | 4 | 5 | 6 | 7 | 8 | 9 | 10 | 11 | 12 | 13 | 14 | 15 | 16 | 17 | 18 |
| S | P | M | W | H | 1 | 2 | 2 | 9 | A | Q | 7 | S | G | R | 0 | S | A |

| Digit | PKG Information | Code | Specification | | |
|-------|------------------------------|----------------|--|--|--|
| 1 2 3 | Samsung Package Middle Power | SPM | Middle power | | |
| 4 5 | Color | WH | White | | |
| 6 | Product Version | 1 | 1 st version | | |
| 7 8 9 | Form Factor | 229 | 2.8 x 3.5 x 0.65 mm; 2 pads; 3chip; | | |
| 10 | Sorting Current (mA) | A | 100 mA | | |
| 11 | Chromaticity Coordinates | Q | Hot bin | | |
| 12 | CRI | 7 | Min. 90 | | |
| 13 14 | Forward Voltage (V) | SG or SK | 8.8~10.0 Bin Code | GZ 8.8 ~ 9.1 | |
| | | | | G1 9.1 ~ 9.4 | |
| | | | G2 9.4 ~ 9.7 | | |
| | | | G3 9.7 ~ 10.0 | | |
| | | | SG : 4,000ea per reel ,SK : 12,000ea per reel | | |
| 15 16 | CCT (K) | W☆ | 2700 | W1, W2, W3, W4, W5, W6, W7, W8, W9, WA, WB, WC, WD, WE, WF, WG | |
| | | V☆ | 3000 | V1, V2, V3, V4, V5, V6, V7, V8, V9, VA, VB, VC, VD, VE, VF, VG | |
| | | U☆ | 3500 | U1, U2, U3, U4, U5, U6, U7, U8, U9, UA, UB, UC, UD, UE, UF, UG | |
| | | T☆ | 4000 | Bin Code: | T1, T2, T3, T4, T5, T6, T7, T8, T9, TA, TB, TC, TD, TE, TF, TG |
| | | R☆ | 5000 | | R1, R2, R3, R4, R5, R6, R7, R8, R9,RA,RB,RC,RD,RE,RF,RG |
| | | Q☆ | 5700 | | Q1, Q2, Q3, Q4, Q5, Q6, Q7, Q8, Q9,QA,QB,QC,QD,QE,QF,QG |
| | | P☆ | 6500 | | P1, P2, P3, P4, P5, P6, P7, P8, P9,PA,PB,PC,PD,PE,PF,PG |
| | | | ☆ : "0" (Whole bin) "M" (Quarter bin) or "K" (kitting bin) | | |
| 17 18 | Luminous Flux | SA | | SA | |
| | | SB | Bin Code: | SB | |

a) Luminous Flux Bins ($I_f = 100 \text{ mA}$, $T_s = 25^\circ\text{C}$)

| CRI (R _a) Min. | Nominal CCT (K) | Product Code | Flux Bin | Flux Range (Φ_v , lm) |
|-------------------------------|--------------------|--------------------|----------|--------------------------------|
| 90 | 2700 | SPMWH1229AQ7SGW☆SA | SA | 88 ~ 94 |
| | | SPMWH1229AQ7SGW☆SB | SB | 94 ~ 104 |
| | 3000 | SPMWH1229AQ7SGV☆SA | SA | 91 ~ 98 |
| | | SPMWH1229AQ7SGV☆SB | SB | 98 ~ 108 |
| | 3500 | SPMWH1229AQ7SGU☆SA | SA | 93 ~ 100 |
| | | SPMWH1229AQ7SGU☆SB | SB | 100 ~ 110 |
| | 4000 | SPMWH1229AQ7SGT☆SA | SA | 96 ~ 103 |
| | | SPMWH1229AQ7SGT☆SB | SB | 103 ~ 113 |
| | 5000 | SPMWH1229AQ7SGR☆SA | SA | 98 ~ 105 |
| | | SPMWH1229AQ7SGR☆SB | SB | 105 ~ 115 |
| | 5700 | SPMWH1229AQ7SGQ☆SA | SA | 97 ~ 104 |
| | | SPMWH1229AQ7SGQ☆SB | SB | 104 ~ 114 |
| | 6500 | SPMWH1229AQ7SGP☆SA | SA | 96 ~ 103 |
| | | SPMWH1229AQ7SGP☆SB | SB | 103 ~ 113 |

Note: ☆" can be "0" (Whole bin), "M" (Quarter bin) or "K" (Kitting bin) of the color binning

b) Kitting rule

1) Kitting bin Concept

1. Under agreement between customer and SAMSUNG ELECTRONICS, SAMSUNG can supply kitting bin (VF, Color, Im).
2. A forward voltage (VF) of kitting bin is combined by a pair of same VF rank such as (GZ+GZ), (G1+G1), (G2+G2) or (G3+G3).
3. A Chromaticity Coordinates of kitting bin is mixed by kitting procedure.(below kitting simulation)

[Kitting example]

| | | | |
|---|---|---|---|
| D | E | F | G |
| 9 | A | B | C |
| 5 | 6 | 7 | 8 |
| 1 | 2 | 3 | 4 |

[Binning Information]

| | Bin #1 | Bin #2 |
|-----|----------------|----------------|
| VF | GZ | GZ |
| | G1 | G1 |
| | G2 | G2 |
| | G3 | G3 |
| CIE | 1, 2, 5 bin | C, F, G bin |
| | 6, 7, A, B bin | 6, 7, A, B bin |
| | 3, 4, 8 bin | 9, D, E bin |

c) Color Bins ($I_F = 100 \text{ mA}$, $T_s = 25 \text{ }^\circ\text{C}$)

| CRI (R _a) Min. | Nominal CCT (K) | Product Code | Color Rank | Chromaticity Bins |
|-------------------------------|--------------------|--------------------|------------------|--|
| 90 | 2700 | SPMWH1229AQ7SGW0S★ | W0 (Whole bin) | W1, W2, W3, W4, W5, W6, W7, W8, W9, WA, WB, WC, WD, WE, WF, WG |
| | | SPMWH1229AQ7SGWMS★ | WM (Quarter bin) | W6, W7, WA, WB |
| | | SPMWH1229AQ7SGWKS★ | WK (Kitting bin) | W1, W2, W3, W4, W5, W6, W7, W8, W9, WA, WB, WC, WD, WE, WF, WG |
| | | SPMWH1229AQ7SGV0S★ | V0 (Whole bin) | V1, V2, V3, V4, V5, V6, V7, V8, V9, VA, VB, VC, VD, VE, VF, VG |
| | | SPMWH1229AQ7SGVMS★ | VM (Quarter bin) | V6, V7, VA, VB |
| | | SPMWH1229AQ7SGVKS★ | VK (Kitting bin) | V1, V2, V3, V4, V5, V6, V7, V8, V9, VA, VB, VC, VD, VE, VF, VG |
| | 3000 | SPMWH1229AQ7SGU0S★ | U0 (Whole bin) | U1, U2, U3, U4, U5, U6, U7, U8, U9, UA, UB, UC, UD, UE, UF, UG |
| | | SPMWH1229AQ7SGUMS★ | UM (Quarter bin) | U6, U7, UA, UB |
| | | SPMWH1229AQ7SGUKS★ | UK (Kitting bin) | U1, U2, U3, U4, U5, U6, U7, U8, U9, UA, UB, UC, UD, UE, UF, UG |
| | | SPMWH1229AQ7SGT0S★ | T0 (Whole bin) | T1, T2, T3, T4, T5, T6, T7, T8, T9, TA, TB, TC, TD, TE, TF, TG |
| | | SPMWH1229AQ7SGTMS★ | TM (Quarter bin) | T6, T7, TA, TB |
| | | SPMWH1229AQ7SGTKS★ | TK (Kitting bin) | T1, T2, T3, T4, T5, T6, T7, T8, T9, TA, TB, TC, TD, TE, TF, TG |
| | 5000 | SPMWH1229AQ7SGR0S★ | R0 (Whole bin) | R1, R2, R3, R4, R5, R6, R7, R8, R9, RA, RB, RC, RD, RE, RF, RG |
| | | SPMWH1229AQ7SGRMS★ | RM (Quarter bin) | R6, R7, RA, RB |
| | | SPMWH1229AQ7SGRKS★ | RK (Kitting bin) | R1, R2, R3, R4, R5, R6, R7, R8, R9, RA, RB, RC, RD, RE, RF, RG |
| | | SPMWH1229AQ7SGQ0S★ | Q0 (Whole bin) | Q1, Q2, Q3, Q4, Q5, Q6, Q7, Q8, Q9, QA, QB, QC, QD, QE, QF, QG |
| | | SPMWH1229AQ7SGQMS★ | QM (Quarter bin) | Q6, Q7, QA, QB |
| | | SPMWH1229AQ7SGQKS★ | QK (Kitting bin) | Q1, Q2, Q3, Q4, Q5, Q6, Q7, Q8, Q9, QA, QB, QC, QD, QE, QF, QG |
| | 6500 | SPMWH1229AQ7SGP0S★ | P0 (Whole bin) | P1, P2, P3, P4, P5, P6, P7, P8, P9, PA, PB, PC, PD, PE, PF, PG |
| | | SPMWH1229AQ7SGPMS★ | PM (Quarter bin) | P6, P7, PA, PB |
| | | SPMWH1229AQ7SGPKS★ | PK (Kitting bin) | P1, P2, P3, P4, P5, P6, P7, P8, P9, PA, PB, PC, PD, PE, PF, PG |

Note:

★ can be "SA" or "SB" of luminous flux bin

d) Voltage Bins ($I_F = 100 \text{ mA}$, $T_s = 25 \text{ °C}$)

| CRI (R_a) Min. | Nominal CCT (K) | Product Code | Voltage Rank | Voltage Bin | Voltage Range (V) |
|-----------------------|--------------------|--------------|--------------|-------------|----------------------|
| - | - | - | | GZ | 8.8 ~ 9.1 |
| | | | SG | G1 | 9.1 ~ 9.4 |
| | | | or | | |
| | | | SK | G2 | 9.4 ~ 9.7 |
| | | | | G3 | 9.7 ~ 10.0 |

e) Chromaticity Region & Coordinates ($I_F = 100 \text{ mA}$, $T_s = 25 \text{ }^\circ\text{C}$)

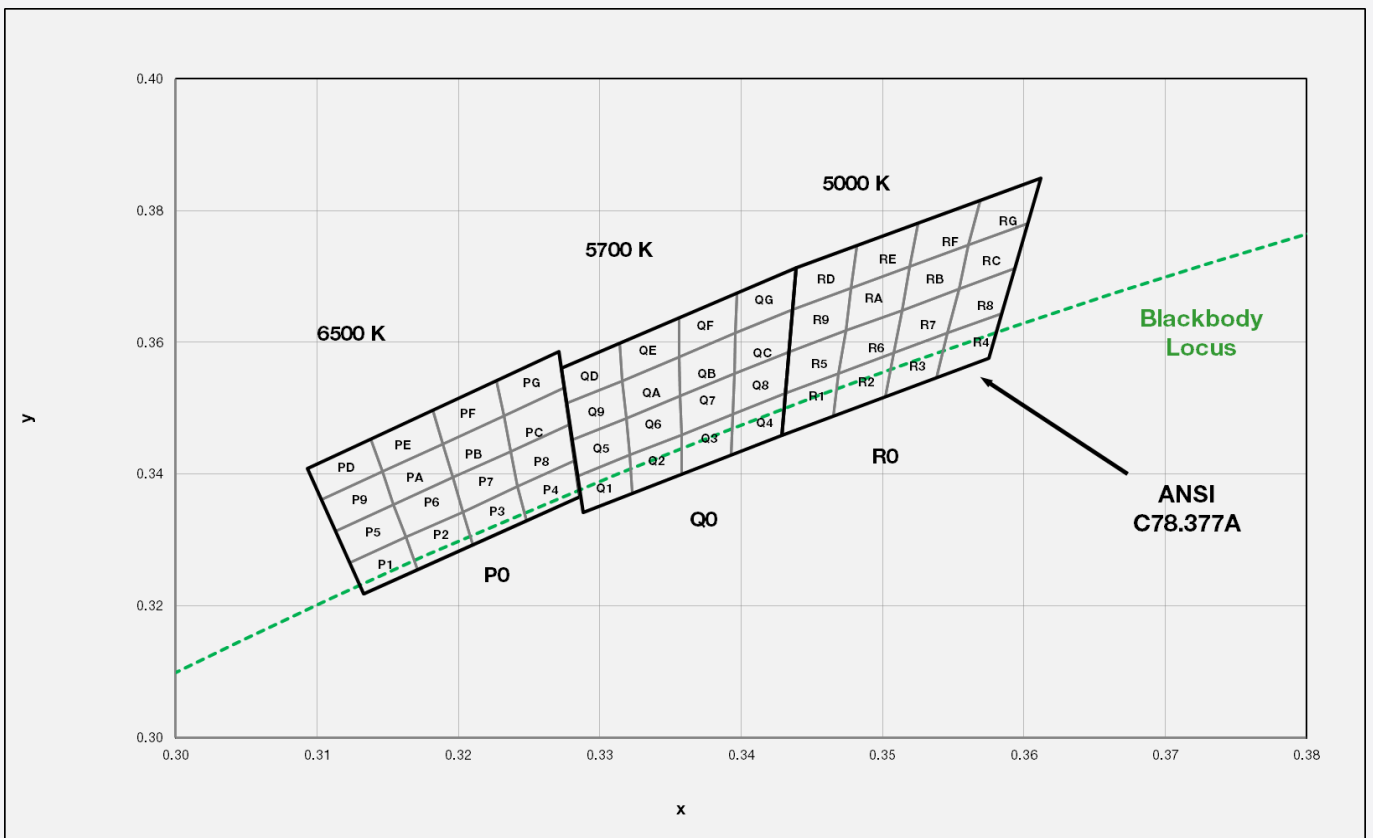
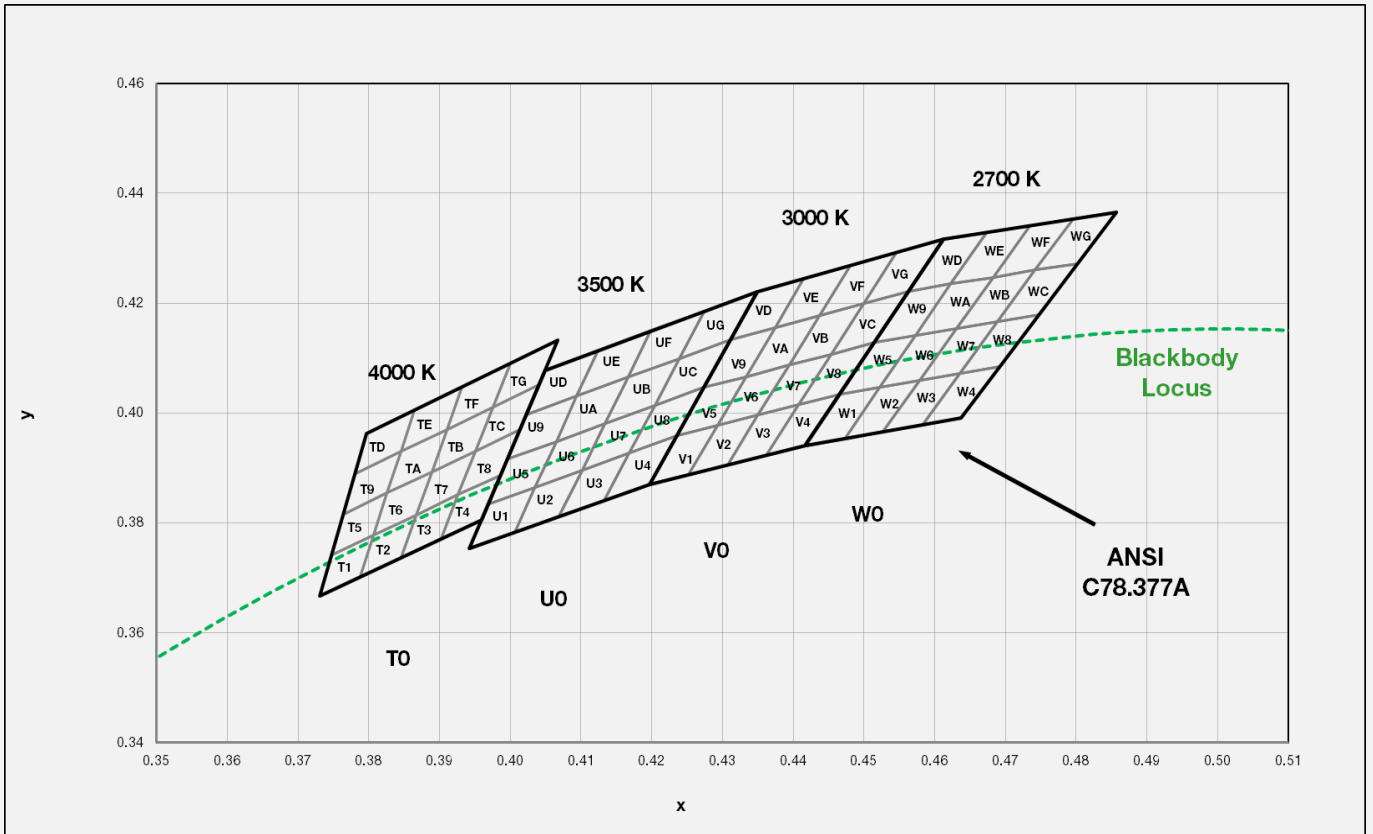

e) Chromaticity Region & Coordinates

| Region | CIE x | CIE y | Region | CIE x | CIE y |
|------------------------|--------|--------|--------|--------|--------|
| W rank (2700 K) | | | | | |
| W1 | 0.4417 | 0.3940 | W9 | 0.4515 | 0.4128 |
| | 0.4472 | 0.3953 | | 0.4573 | 0.4141 |
| | 0.4522 | 0.4047 | | 0.4623 | 0.4235 |
| | 0.4466 | 0.4034 | | 0.4563 | 0.4222 |
| W2 | 0.4472 | 0.3953 | WA | 0.4573 | 0.4141 |
| | 0.4527 | 0.3966 | | 0.4631 | 0.4153 |
| | 0.4579 | 0.4059 | | 0.4683 | 0.4247 |
| | 0.4522 | 0.4047 | | 0.4623 | 0.4235 |
| W3 | 0.4527 | 0.3966 | WB | 0.4631 | 0.4153 |
| | 0.4582 | 0.3978 | | 0.4689 | 0.4166 |
| | 0.4635 | 0.4072 | | 0.4742 | 0.4260 |
| | 0.4579 | 0.4059 | | 0.4683 | 0.4247 |
| W4 | 0.4582 | 0.3978 | WC | 0.4689 | 0.4166 |
| | 0.4637 | 0.3991 | | 0.4747 | 0.4179 |
| | 0.4692 | 0.4085 | | 0.4802 | 0.4272 |
| | 0.4635 | 0.4072 | | 0.4742 | 0.4260 |
| W5 | 0.4466 | 0.4034 | WD | 0.4563 | 0.4222 |
| | 0.4522 | 0.4047 | | 0.4623 | 0.4235 |
| | 0.4573 | 0.4141 | | 0.4673 | 0.4329 |
| | 0.4515 | 0.4128 | | 0.4612 | 0.4316 |
| W6 | 0.4522 | 0.4047 | WE | 0.4623 | 0.4235 |
| | 0.4579 | 0.4059 | | 0.4683 | 0.4247 |
| | 0.4631 | 0.4153 | | 0.4735 | 0.4341 |
| | 0.4573 | 0.4141 | | 0.4673 | 0.4329 |
| W7 | 0.4579 | 0.4059 | WF | 0.4683 | 0.4247 |
| | 0.4635 | 0.4072 | | 0.4742 | 0.4260 |
| | 0.4689 | 0.4166 | | 0.4796 | 0.4354 |
| | 0.4631 | 0.4153 | | 0.4735 | 0.4341 |
| W8 | 0.4635 | 0.4072 | WG | 0.4742 | 0.4260 |
| | 0.4692 | 0.4085 | | 0.4802 | 0.4272 |
| | 0.4747 | 0.4179 | | 0.4857 | 0.4366 |
| | 0.4689 | 0.4166 | | 0.4796 | 0.4354 |

| Region | CIE x | CIE y | Region | CIE x | CIE y |
|------------------------|--------|--------|--------|--------|--------|
| V rank (3000 K) | | | | | |
| V1 | 0.4197 | 0.3870 | V9 | 0.4273 | 0.4046 |
| | 0.4252 | 0.3888 | | 0.4333 | 0.4066 |
| | 0.4293 | 0.3977 | | 0.4374 | 0.4155 |
| | 0.4235 | 0.3958 | | 0.4311 | 0.4133 |
| V2 | 0.4252 | 0.3888 | VA | 0.4333 | 0.4066 |
| | 0.4307 | 0.3905 | | 0.4394 | 0.4087 |
| | 0.4350 | 0.3996 | | 0.4437 | 0.4178 |
| | 0.4293 | 0.3977 | | 0.4374 | 0.4155 |
| V3 | 0.4307 | 0.3905 | VB | 0.4394 | 0.4087 |
| | 0.4362 | 0.3923 | | 0.4454 | 0.4107 |
| | 0.4408 | 0.4015 | | 0.4500 | 0.4200 |
| | 0.4350 | 0.3996 | | 0.4437 | 0.4178 |
| V4 | 0.4362 | 0.3923 | VC | 0.4454 | 0.4107 |
| | 0.4417 | 0.3940 | | 0.4515 | 0.4128 |
| | 0.4466 | 0.4034 | | 0.4563 | 0.4222 |
| | 0.4408 | 0.4015 | | 0.4500 | 0.4200 |
| V5 | 0.4235 | 0.3958 | VD | 0.4311 | 0.4133 |
| | 0.4293 | 0.3977 | | 0.4374 | 0.4155 |
| | 0.4333 | 0.4066 | | 0.4415 | 0.4245 |
| | 0.4273 | 0.4046 | | 0.4349 | 0.4221 |
| V6 | 0.4293 | 0.3977 | VE | 0.4374 | 0.4155 |
| | 0.4350 | 0.3996 | | 0.4437 | 0.4178 |
| | 0.4394 | 0.4087 | | 0.4481 | 0.4269 |
| | 0.4333 | 0.4066 | | 0.4415 | 0.4245 |
| V7 | 0.4350 | 0.3996 | VF | 0.4437 | 0.4178 |
| | 0.4408 | 0.4015 | | 0.4500 | 0.4200 |
| | 0.4454 | 0.4107 | | 0.4546 | 0.4292 |
| | 0.4394 | 0.4087 | | 0.4481 | 0.4269 |
| V8 | 0.4408 | 0.4015 | VG | 0.4500 | 0.4200 |
| | 0.4466 | 0.4034 | | 0.4563 | 0.4222 |
| | 0.4515 | 0.4128 | | 0.4612 | 0.4316 |
| | 0.4454 | 0.4107 | | 0.4546 | 0.4292 |

e) Chromaticity Region & Coordinates

| Region | CIE x | CIE y | Region | CIE x | CIE y |
|------------------------|--------|--------|--------|--------|--------|
| U rank (3500 K) | | | | | |
| U1 | 0.3942 | 0.3753 | U9 | 0.3995 | 0.3916 |
| | 0.4006 | 0.3782 | | 0.4065 | 0.3948 |
| | 0.4035 | 0.3865 | | 0.4094 | 0.4031 |
| | 0.3969 | 0.3834 | | 0.4022 | 0.3997 |
| U2 | 0.4006 | 0.3782 | UA | 0.4065 | 0.3948 |
| | 0.4069 | 0.3812 | | 0.4134 | 0.3981 |
| | 0.4102 | 0.3896 | | 0.4167 | 0.4065 |
| | 0.4035 | 0.3865 | | 0.4094 | 0.4031 |
| U3 | 0.4069 | 0.3812 | UB | 0.4134 | 0.3981 |
| | 0.4133 | 0.3841 | | 0.4204 | 0.4013 |
| | 0.4168 | 0.3927 | | 0.4239 | 0.4099 |
| | 0.4102 | 0.3896 | | 0.4167 | 0.4065 |
| U4 | 0.4133 | 0.3841 | UC | 0.4204 | 0.4013 |
| | 0.4197 | 0.3870 | | 0.4273 | 0.4046 |
| | 0.4235 | 0.3958 | | 0.4311 | 0.4133 |
| | 0.4168 | 0.3927 | | 0.4239 | 0.4099 |
| U5 | 0.3969 | 0.3834 | UD | 0.4022 | 0.3997 |
| | 0.4035 | 0.3865 | | 0.4094 | 0.4031 |
| | 0.4065 | 0.3948 | | 0.4124 | 0.4114 |
| | 0.3995 | 0.3916 | | 0.4049 | 0.4078 |
| U6 | 0.4035 | 0.3865 | UE | 0.4094 | 0.4031 |
| | 0.4102 | 0.3896 | | 0.4167 | 0.4065 |
| | 0.4134 | 0.3981 | | 0.4199 | 0.4150 |
| | 0.4065 | 0.3948 | | 0.4124 | 0.4114 |
| U7 | 0.4102 | 0.3896 | UF | 0.4167 | 0.4065 |
| | 0.4168 | 0.3927 | | 0.4239 | 0.4099 |
| | 0.4204 | 0.4013 | | 0.4274 | 0.4185 |
| | 0.4134 | 0.3981 | | 0.4199 | 0.4150 |
| U8 | 0.4168 | 0.3927 | UG | 0.4239 | 0.4099 |
| | 0.4235 | 0.3958 | | 0.4311 | 0.4133 |
| | 0.4273 | 0.4046 | | 0.4349 | 0.4221 |
| | 0.4204 | 0.4013 | | 0.4274 | 0.4185 |

| Region | CIE x | CIE y | Region | CIE x | CIE y |
|------------------------|--------|--------|--------|--------|--------|
| T rank (4000 K) | | | | | |
| T1 | 0.3731 | 0.3667 | T9 | 0.3764 | 0.3815 |
| | 0.3788 | 0.3702 | | 0.3826 | 0.3854 |
| | 0.3807 | 0.3778 | | 0.3845 | 0.3930 |
| | 0.3748 | 0.3741 | | 0.3781 | 0.3889 |
| T2 | 0.3788 | 0.3702 | TA | 0.3826 | 0.3854 |
| | 0.3845 | 0.3736 | | 0.3889 | 0.3892 |
| | 0.3867 | 0.3814 | | 0.3910 | 0.3970 |
| | 0.3807 | 0.3778 | | 0.3845 | 0.3930 |
| T3 | 0.3845 | 0.3736 | TB | 0.3889 | 0.3892 |
| | 0.3902 | 0.3771 | | 0.3951 | 0.3931 |
| | 0.3926 | 0.3851 | | 0.3975 | 0.4011 |
| | 0.3867 | 0.3814 | | 0.3910 | 0.3970 |
| T4 | 0.3902 | 0.3771 | TC | 0.3951 | 0.3931 |
| | 0.3959 | 0.3805 | | 0.4013 | 0.3969 |
| | 0.3986 | 0.3887 | | 0.4040 | 0.4051 |
| | 0.3926 | 0.3851 | | 0.3975 | 0.4011 |
| T5 | 0.3748 | 0.3741 | TD | 0.3781 | 0.3889 |
| | 0.3807 | 0.3778 | | 0.3845 | 0.3930 |
| | 0.3826 | 0.3854 | | 0.3865 | 0.4006 |
| | 0.3764 | 0.3815 | | 0.3797 | 0.3963 |
| T6 | 0.3807 | 0.3778 | TE | 0.3845 | 0.3930 |
| | 0.3867 | 0.3814 | | 0.3910 | 0.3970 |
| | 0.3889 | 0.3892 | | 0.3932 | 0.4048 |
| | 0.3826 | 0.3854 | | 0.3865 | 0.4006 |
| T7 | 0.3867 | 0.3814 | TF | 0.3910 | 0.3970 |
| | 0.3926 | 0.3851 | | 0.3975 | 0.4011 |
| | 0.3951 | 0.3931 | | 0.4000 | 0.4091 |
| | 0.3889 | 0.3892 | | 0.3932 | 0.4048 |
| T8 | 0.3926 | 0.3851 | TG | 0.3975 | 0.4011 |
| | 0.3986 | 0.3887 | | 0.4040 | 0.4051 |
| | 0.4013 | 0.3969 | | 0.4067 | 0.4133 |
| | 0.3951 | 0.3931 | | 0.4000 | 0.4091 |

e) Chromaticity Region & Coordinates

| Region | CIE x | CIE y | Region | CIE x | CIE y |
|------------------------|--------|--------|--------|--------|--------|
| R rank (5000 K) | | | | | |
| R1 | 0.3429 | 0.3459 | R9 | 0.3434 | 0.3586 |
| | 0.3465 | 0.3489 | | 0.3474 | 0.3618 |
| | 0.3469 | 0.3553 | | 0.3478 | 0.3682 |
| | 0.3431 | 0.3523 | | 0.3436 | 0.3650 |
| R2 | 0.3465 | 0.3489 | RA | 0.3474 | 0.3618 |
| | 0.3502 | 0.3518 | | 0.3514 | 0.3649 |
| | 0.3508 | 0.3584 | | 0.3519 | 0.3715 |
| | 0.3469 | 0.3553 | | 0.3478 | 0.3682 |
| R3 | 0.3502 | 0.3518 | RB | 0.3514 | 0.3649 |
| | 0.3538 | 0.3547 | | 0.3554 | 0.3681 |
| | 0.3546 | 0.3614 | | 0.3561 | 0.3748 |
| | 0.3508 | 0.3584 | | 0.3519 | 0.3715 |
| R4 | 0.3538 | 0.3547 | RC | 0.3554 | 0.3681 |
| | 0.3575 | 0.3576 | | 0.3594 | 0.3713 |
| | 0.3584 | 0.3644 | | 0.3603 | 0.3781 |
| | 0.3546 | 0.3614 | | 0.3561 | 0.3748 |
| R5 | 0.3431 | 0.3523 | RD | 0.3436 | 0.3650 |
| | 0.3469 | 0.3553 | | 0.3478 | 0.3682 |
| | 0.3474 | 0.3618 | | 0.3482 | 0.3747 |
| | 0.3434 | 0.3586 | | 0.3439 | 0.3713 |
| R6 | 0.3469 | 0.3553 | RE | 0.3478 | 0.3682 |
| | 0.3508 | 0.3584 | | 0.3519 | 0.3715 |
| | 0.3514 | 0.3649 | | 0.3525 | 0.3781 |
| | 0.3474 | 0.3618 | | 0.3482 | 0.3747 |
| R7 | 0.3508 | 0.3584 | RF | 0.3519 | 0.3715 |
| | 0.3546 | 0.3614 | | 0.3561 | 0.3748 |
| | 0.3554 | 0.3681 | | 0.3569 | 0.3815 |
| | 0.3514 | 0.3649 | | 0.3525 | 0.3781 |
| R8 | 0.3546 | 0.3614 | RG | 0.3561 | 0.3748 |
| | 0.3584 | 0.3644 | | 0.3603 | 0.3781 |
| | 0.3594 | 0.3713 | | 0.3612 | 0.3849 |
| | 0.3554 | 0.3681 | | 0.3569 | 0.3815 |

| Region | CIE x | CIE y | Region | CIE x | CIE y |
|------------------------|--------|--------|--------|--------|--------|
| Q rank (5700 K) | | | | | |
| Q1 | 0.3288 | 0.3342 | Q9 | 0.3280 | 0.3452 |
| | 0.3323 | 0.3372 | | 0.3319 | 0.3485 |
| | 0.3321 | 0.3429 | | 0.3316 | 0.3542 |
| | 0.3284 | 0.3397 | | 0.3276 | 0.3507 |
| Q2 | 0.3323 | 0.3372 | QA | 0.3319 | 0.3485 |
| | 0.3358 | 0.3401 | | 0.3357 | 0.3519 |
| | 0.3358 | 0.3460 | | 0.3356 | 0.3578 |
| | 0.3321 | 0.3429 | | 0.3316 | 0.3542 |
| Q3 | 0.3358 | 0.3401 | QB | 0.3357 | 0.3519 |
| | 0.3393 | 0.3430 | | 0.3395 | 0.3553 |
| | 0.3394 | 0.3491 | | 0.3396 | 0.3614 |
| | 0.3358 | 0.3460 | | 0.3356 | 0.3578 |
| Q4 | 0.3393 | 0.3430 | QC | 0.3395 | 0.3553 |
| | 0.3429 | 0.3459 | | 0.3434 | 0.3586 |
| | 0.3431 | 0.3523 | | 0.3436 | 0.3650 |
| | 0.3394 | 0.3491 | | 0.3396 | 0.3614 |
| Q5 | 0.3284 | 0.3397 | QD | 0.3276 | 0.3507 |
| | 0.3321 | 0.3429 | | 0.3316 | 0.3542 |
| | 0.3319 | 0.3485 | | 0.3314 | 0.3599 |
| | 0.3280 | 0.3452 | | 0.3273 | 0.3561 |
| Q6 | 0.3321 | 0.3429 | QE | 0.3316 | 0.3542 |
| | 0.3358 | 0.3460 | | 0.3356 | 0.3578 |
| | 0.3357 | 0.3519 | | 0.3356 | 0.3637 |
| | 0.3319 | 0.3485 | | 0.3314 | 0.3599 |
| Q7 | 0.3358 | 0.3460 | QF | 0.3356 | 0.3578 |
| | 0.3394 | 0.3491 | | 0.3396 | 0.3614 |
| | 0.3395 | 0.3553 | | 0.3397 | 0.3675 |
| | 0.3357 | 0.3519 | | 0.3356 | 0.3637 |
| Q8 | 0.3394 | 0.3491 | QG | 0.3396 | 0.3614 |
| | 0.3431 | 0.3523 | | 0.3436 | 0.3650 |
| | 0.3434 | 0.3586 | | 0.3439 | 0.3713 |
| | 0.3395 | 0.3553 | | 0.3397 | 0.3675 |

e) Chromaticity Region & Coordinates

| Region | CIE x | CIE y | Region | CIE x | CIE y |
|------------------------|--------|--------|--------|--------|--------|
| P rank (6500 K) | | | | | |
| P1 | 0.3133 | 0.3218 | P9 | 0.3113 | 0.3314 |
| | 0.3171 | 0.3255 | | 0.3154 | 0.3354 |
| | 0.3163 | 0.3305 | | 0.3146 | 0.3404 |
| | 0.3123 | 0.3266 | | 0.3103 | 0.3361 |
| P2 | 0.3171 | 0.3255 | PA | 0.3154 | 0.3354 |
| | 0.3210 | 0.3292 | | 0.3196 | 0.3395 |
| | 0.3203 | 0.3343 | | 0.3189 | 0.3446 |
| | 0.3163 | 0.3305 | | 0.3146 | 0.3404 |
| P3 | 0.3210 | 0.3292 | PB | 0.3196 | 0.3395 |
| | 0.3248 | 0.3329 | | 0.3237 | 0.3435 |
| | 0.3242 | 0.3382 | | 0.3232 | 0.3489 |
| | 0.3203 | 0.3343 | | 0.3189 | 0.3446 |
| P4 | 0.3248 | 0.3329 | PC | 0.3237 | 0.3435 |
| | 0.3286 | 0.3366 | | 0.3279 | 0.3476 |
| | 0.3282 | 0.3421 | | 0.3275 | 0.3531 |
| | 0.3242 | 0.3382 | | 0.3232 | 0.3489 |
| P5 | 0.3123 | 0.3266 | PD | 0.3103 | 0.3361 |
| | 0.3163 | 0.3305 | | 0.3146 | 0.3404 |
| | 0.3154 | 0.3354 | | 0.3138 | 0.3453 |
| | 0.3113 | 0.3314 | | 0.3093 | 0.3409 |
| P6 | 0.3163 | 0.3305 | PE | 0.3146 | 0.3404 |
| | 0.3203 | 0.3343 | | 0.3189 | 0.3446 |
| | 0.3196 | 0.3395 | | 0.3182 | 0.3498 |
| | 0.3154 | 0.3354 | | 0.3138 | 0.3453 |
| P7 | 0.3203 | 0.3343 | PF | 0.3189 | 0.3446 |
| | 0.3242 | 0.3382 | | 0.3232 | 0.3489 |
| | 0.3237 | 0.3435 | | 0.3227 | 0.3542 |
| | 0.3196 | 0.3395 | | 0.3182 | 0.3498 |
| P8 | 0.3242 | 0.3382 | PG | 0.3232 | 0.3489 |
| | 0.3282 | 0.3421 | | 0.3275 | 0.3531 |
| | 0.3279 | 0.3476 | | 0.3271 | 0.3586 |
| | 0.3237 | 0.3435 | | 0.3227 | 0.3542 |

Note: Samsung maintains measurement tolerance of: Cx, Cy = ±0.005

3. Typical Characteristics Graphs

a) Spectrum Distribution ($I_f = 100 \text{ mA}$, $T_s = 25 \text{ }^\circ\text{C}$)

CCT: 2700 K (90 CRI)

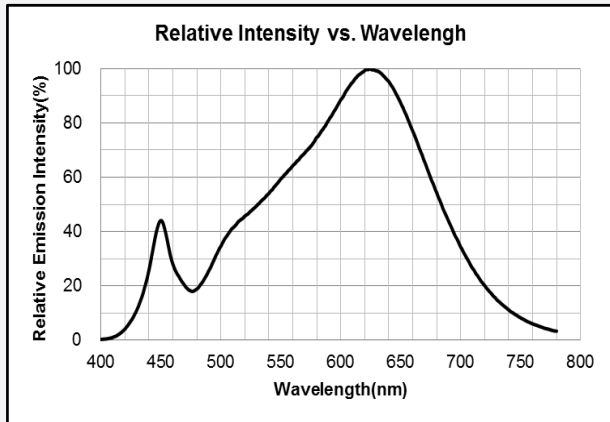

CCT: 3000 K (90 CRI)

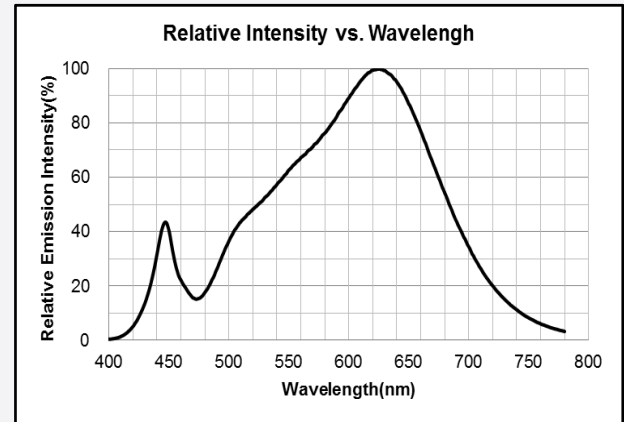

CCT: 3500 K (90 CRI)

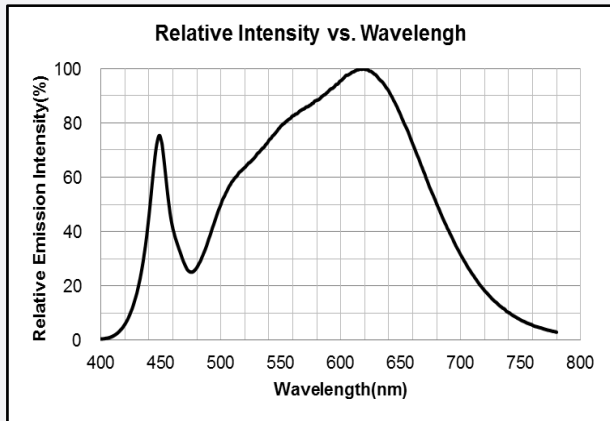

CCT: 4000 K (90 CRI)

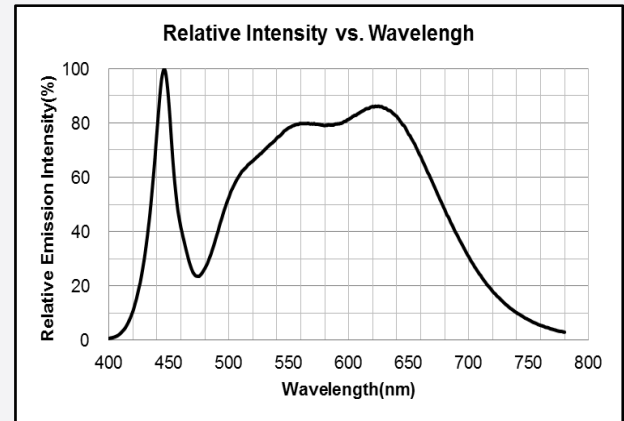

CCT: 5000 K (90 CRI)

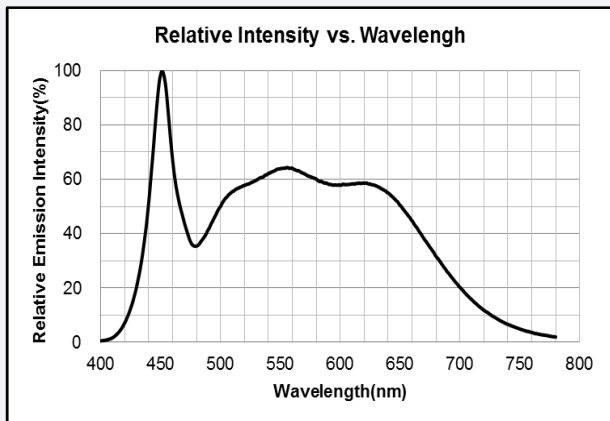

CCT: 5700 K (90 CRI)

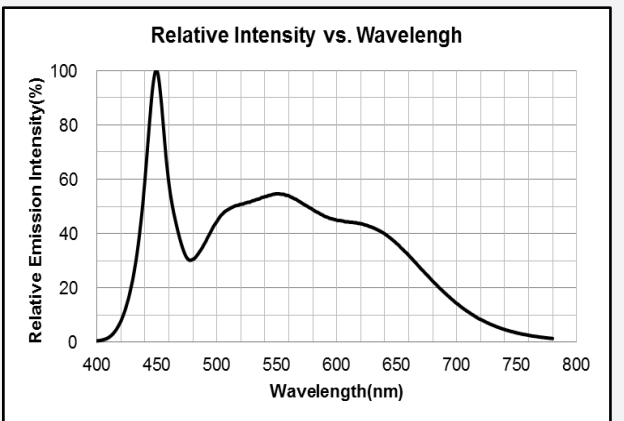

CCT: 6500 K (90 CRI)

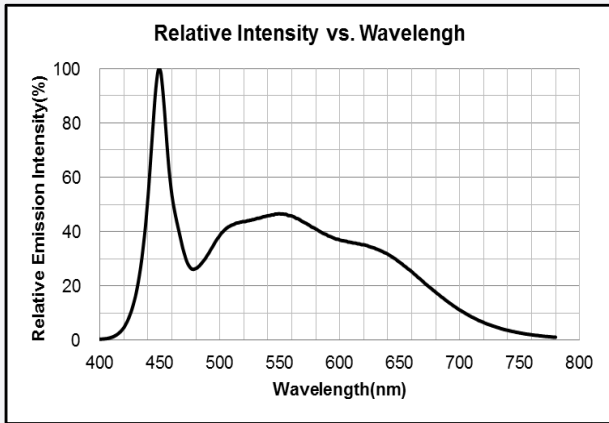

b) Forward Current Characteristics ($T_s = 25\text{ }^\circ\text{C}$)

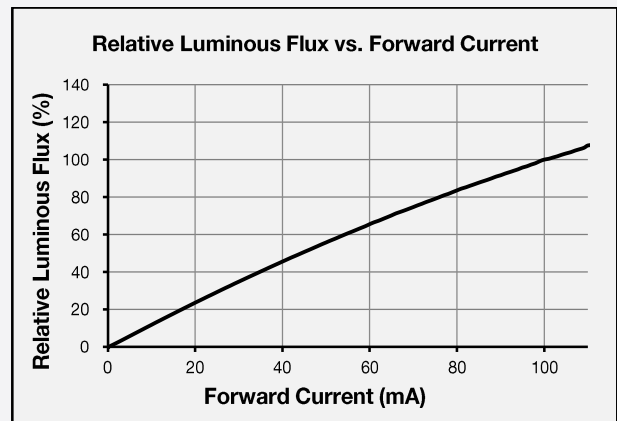
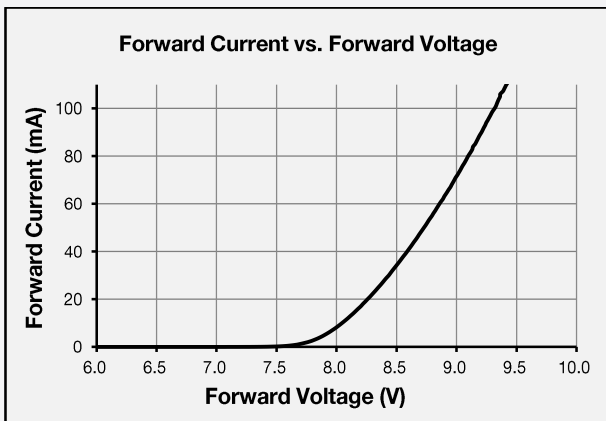

c) Temperature Characteristics ($I_F = 100\text{ mA}$)

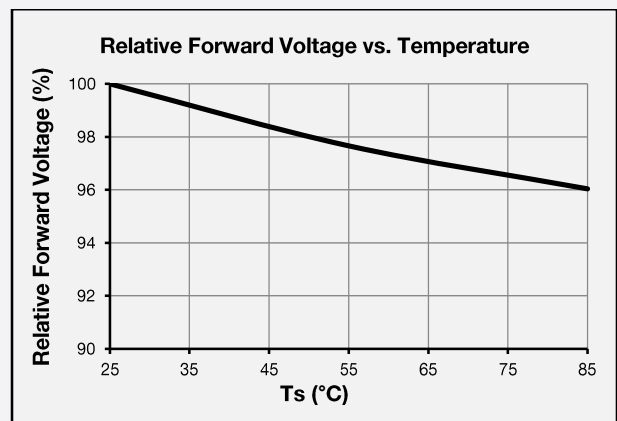
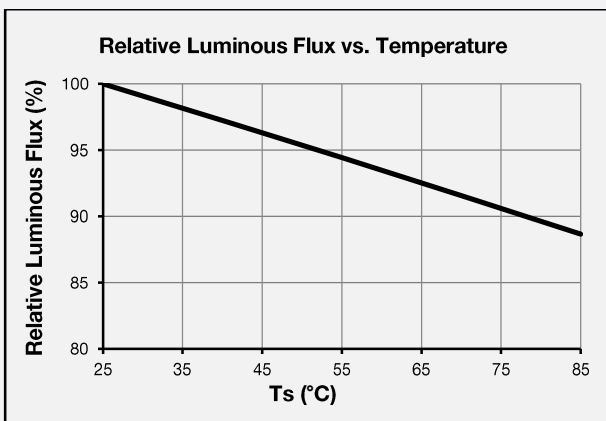

d) Color Shift Characteristics ($I_F = 100 \text{ mA}$, $T_s = 25 \text{ }^\circ\text{C}$)

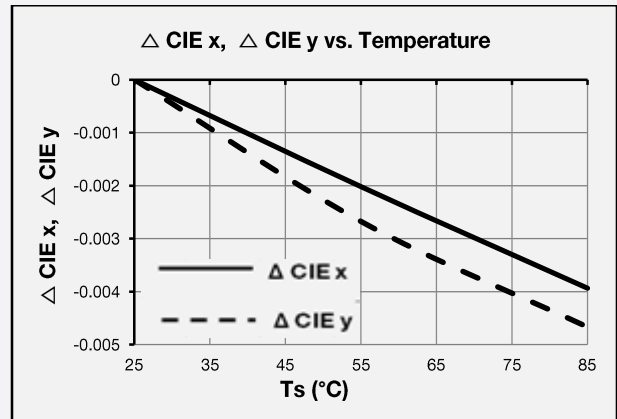
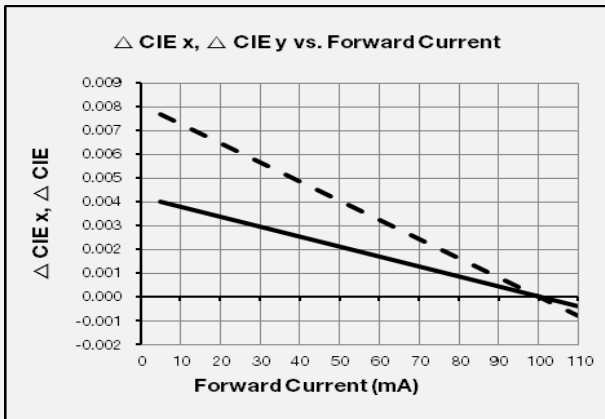

e) Derating Curve

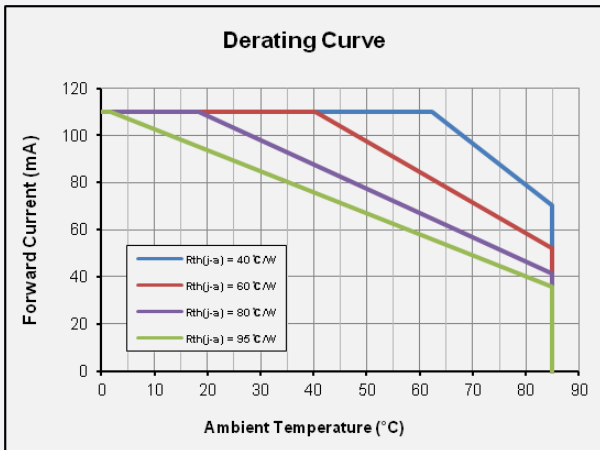

f) Beam Angle Characteristics ($I_F = 100 \text{ mA}$, $T_s = 25 \text{ }^\circ\text{C}$)

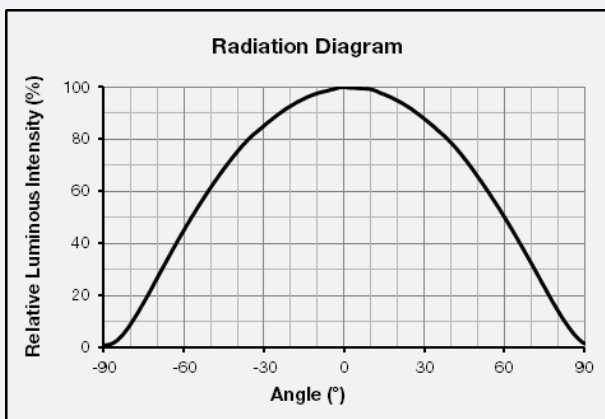

4. Outline Drawing & Dimension

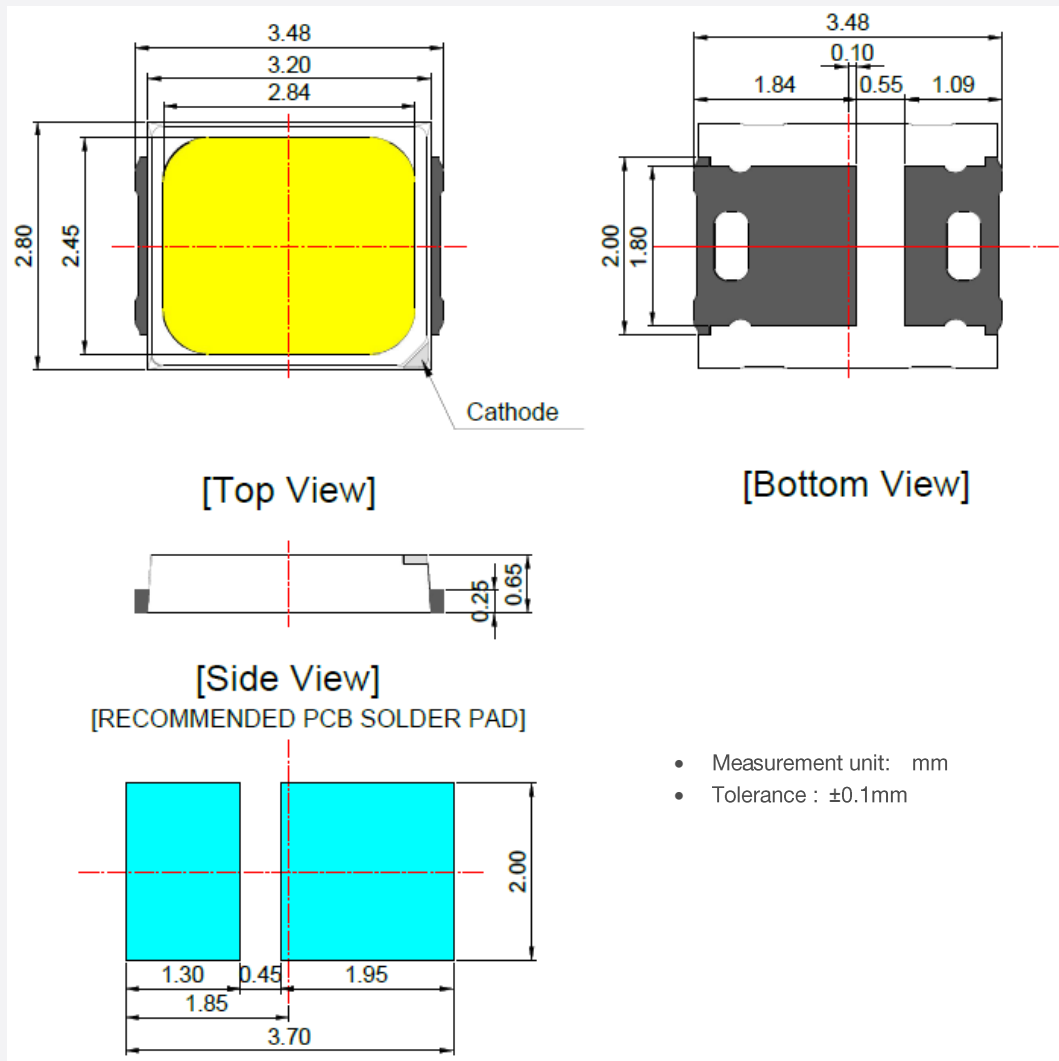

Notes:

- 1) T_s point and measurement method:
 - ① Measure one point at the cathode pad, if necessary remove PSR of PCB to reach T_s point.
 - ② All pads must be soldered to the PCB to dissipate heat properly, otherwise the LED can be damaged.

Precautions:

- 1) Pressure on the LEDs will influence to the reliability of the LEDs. Precautions should be taken to avoid strong pressure on the LEDs. Do not put stress on the LEDs during heating.
- 2) Re-soldering should not be done after the LEDs have been soldered. If re-soldering is unavoidable, LED's characteristics should be carefully checked before and after such repair.
- 3) Do not stack assembled PCBs together. Since materials of LEDs is soft, abrasion between two PCB assembled with LED might cause catastrophic failure of the LEDs.

5. Reliability Test Items & Conditions

a) Test Items

| Test Item | Test Condition | Test Hour / Cycle | Sample No. |
|-------------------------------------|--|-------------------|------------|
| Room Temperature Life Test | 25 °C, DC 110 mA | 1000 h | 22 |
| High Temperature Life Test | 85 °C, DC 110 mA | 1000 h | 22 |
| High Temperature Humidity Life Test | 60 °C, 90 % RH, DC 110 mA | 1000 h | 22 |
| Low Temperature Life Test | -40 °C, DC 110 mA | 1000 h | 22 |
| Powered Temperature Cycle Test | -45 °C ~ 85 °C, each 20 min, on/off 5 min Temp. Change time 100min, DC 110 mA | 100 cycles | 22 |
| Temperature Cycling | -45 °C / 15 min ↔ 125 °C / 15 min | 200 cycles | 100 |
| High Temperature Storage | 85 °C | 1000 h | 11 |
| Low Temperature Storage | -40 °C | 1000 h | 11 |

ESD (HBM)

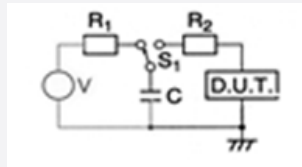

R_1 : 10 M Ω
 R_2 : 1.5 k Ω
 C : 100 pF
 V : ± 2 kV

5 times

30

b) Criteria for Judging the Damage

| Item | Symbol | Test Condition ($T_s = 25^\circ\text{C}$) | Limit | |
|-----------------|----------|--|-------------------|-------------------|
| | | | Min | Max |
| Forward Voltage | V_F | $I_F = 100$ mA | Init. Value * 0.9 | Init. Value * 1.1 |
| Luminous Flux | Φ_v | $I_F = 100$ mA | Init. Value * 0.7 | Init. Value * 1.1 |

6. Soldering Conditions

a) Reflow Conditions (Pb free)

Reflow frequency: 2 times max.

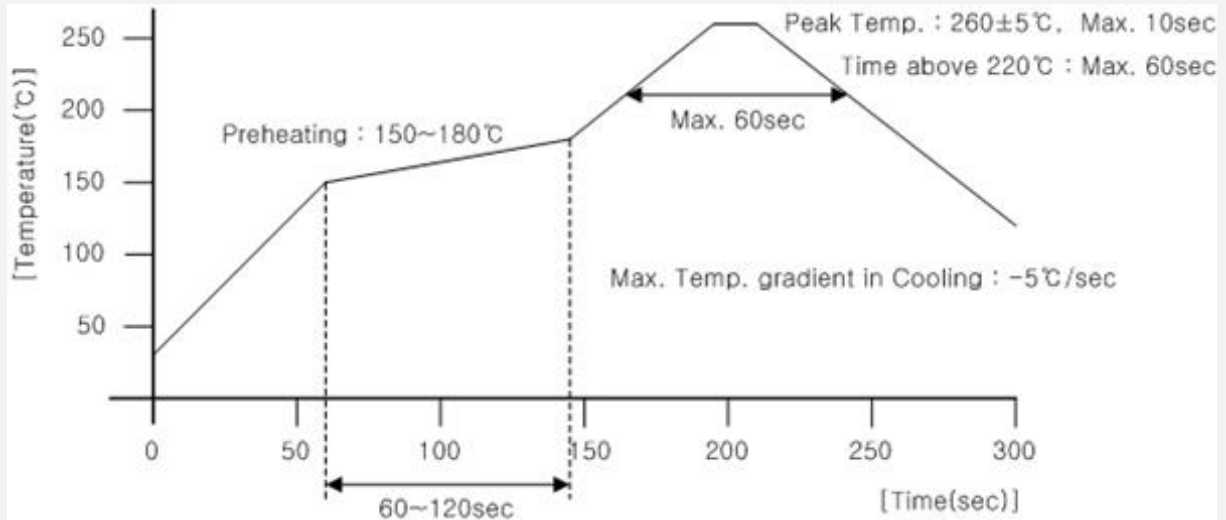

b) Manual Soldering Conditions

Not more than 5 seconds @ max. 300 °C, under soldering iron.

7. Tape & Reel

a) Taping Dimension

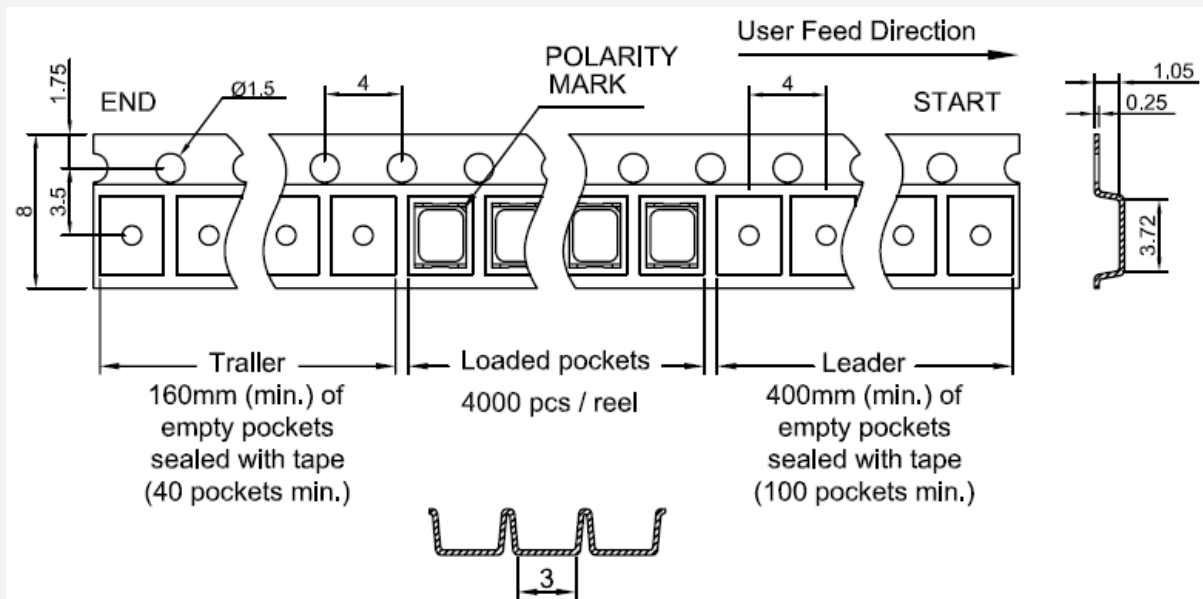

b) Reel Dimension (max 4,000 pcs)

(unit: mm)

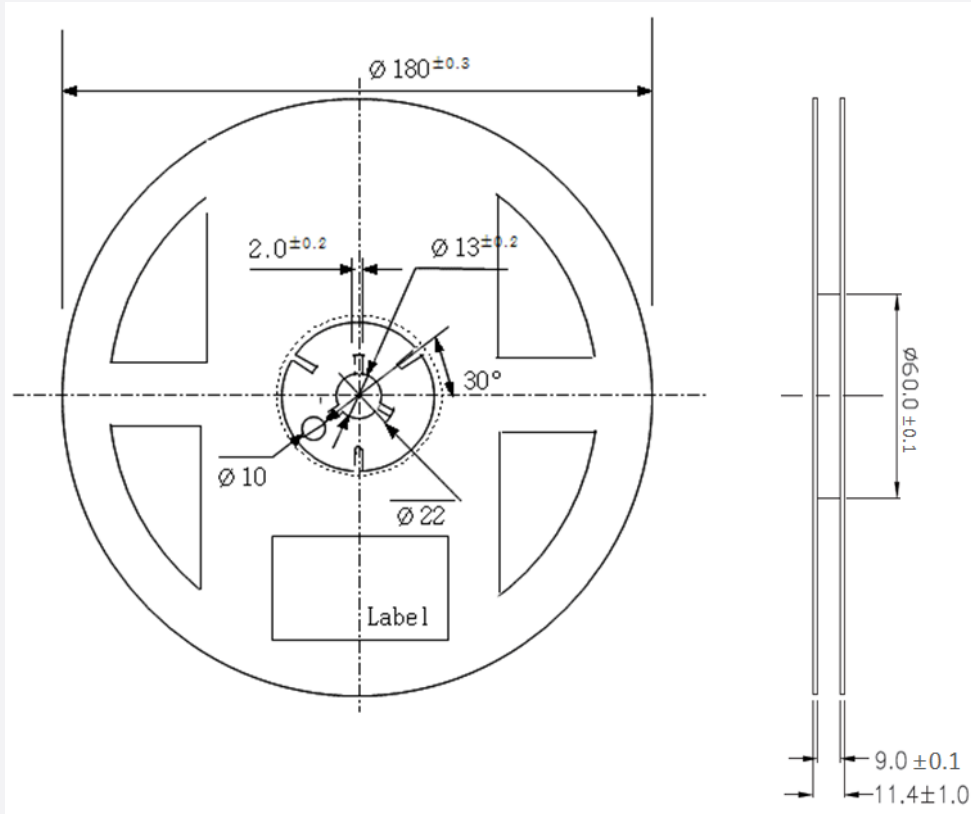
**Notes:**

- 1) Quantity: The quantity/reel is 4,000 pcs
- 2) All dimensions are millimeters (tolerance : ± 0.2 mm)
- 3) Packaging: P/N, Manufacturing data code no. and quantity are indicated on the aluminum packing bag

c) Reel Dimension (max 12,000 pcs)

(unit: mm)

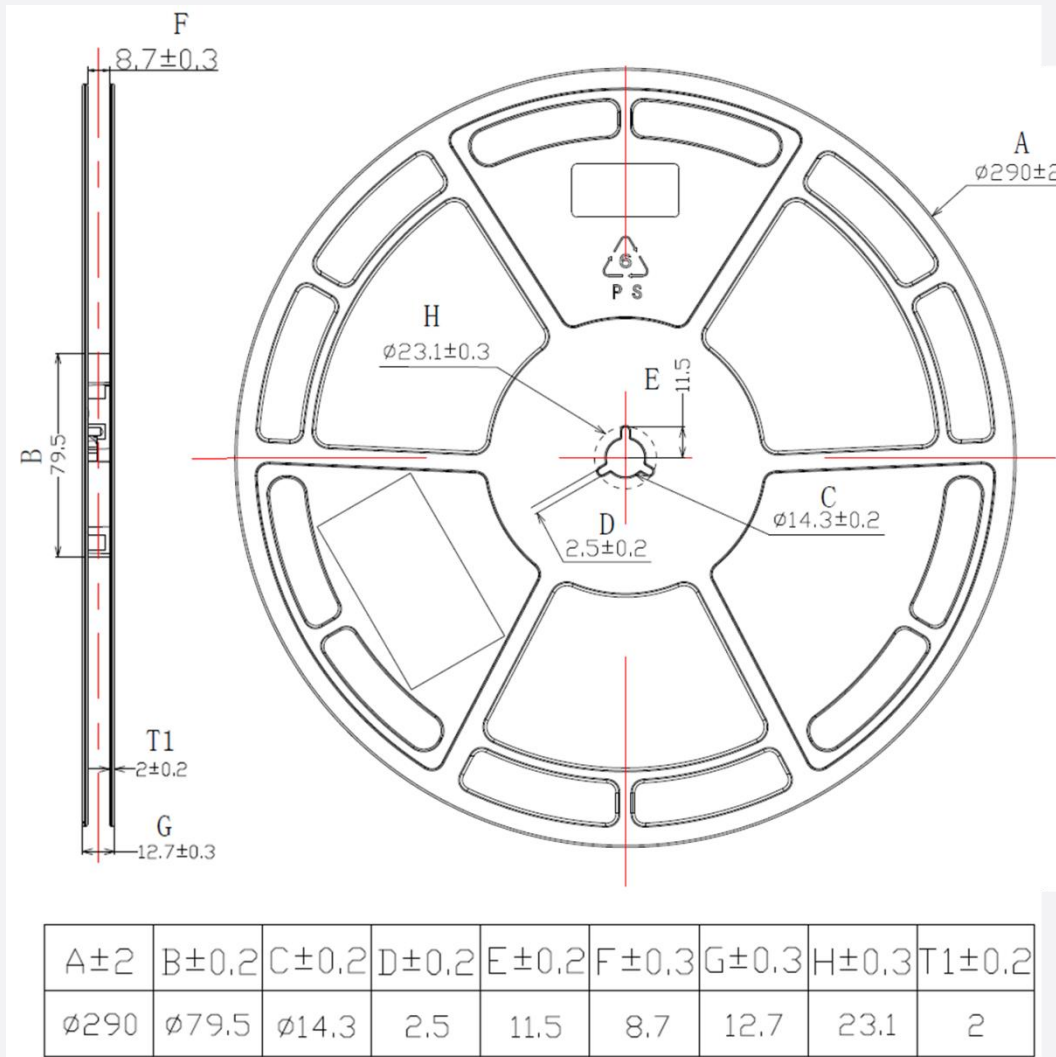

Notes:

- 1) Quantity: The quantity/reel is 12,000 pcs
- 2) All dimensions are millimeters (tolerance : ±0.2mm)
- 3) Packaging: P/N, Manufacturing data code no. and quantity are indicated on the aluminum packing bag

8. Label Structure

a) Label Structure

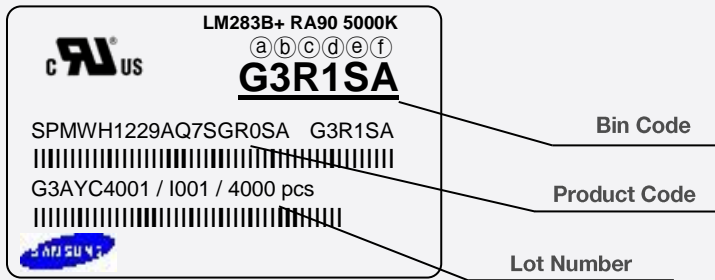

Note: Denoted bin code and product code above is only an example (see description on page 6)

Bin Code:

- ⒶⒷ: Forward Voltage bin (refer to page 10)
- ⒸⒹ: Chromaticity bin (refer to page 8-15)
- ⒺⒻ: Luminous Flux bin (refer to page 7)

b) Lot Number

The lot number is composed of the following characters:



①②③④⑤⑥⑦⑧⑨ / |ⒶⒷⒸ / 4,000 pcs

- ① : Production site (S: Giheung, Korea, G: Tianjin, China)
- ② : 3 (LED)
- ③ : Product state (A: Normal, B: Bulk, C: First Production, R: Reproduction, S: Sample)
- ④ : Year (Z: 2015, A: 2016, B: 2017...)
- ⑤ : Month (1~9, A, B, C)
- ⑥ : Day (1~9, A, B~V)
- ⑦⑧⑨ ⒶⒷⒸ : Product serial number

9. Packing Structure

a) Packing Process (The quantity of PKG on the Reel to be Max 4,000 pcs)

Reel

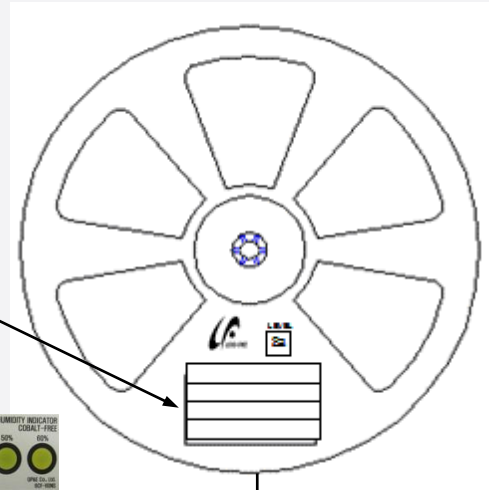
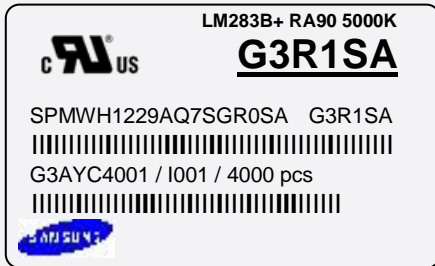

Aluminum Vinyl Packing Bag

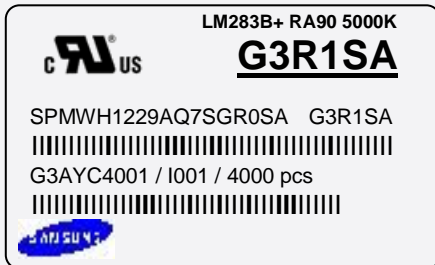

Outer Box

Material: Paper (SW3B(B))

| Type | Size (mm) | | | Note |
|----------|-----------|---------|---------|----------------|
| | L | W | H | |
| 7 inch L | 245 ± 5 | 220 ± 5 | 182 ± 5 | Up to 10 reels |
| 7 inch S | 245 ± 5 | 220 ± 5 | 86 ± 5 | Up to 5 reels |

① Side Label

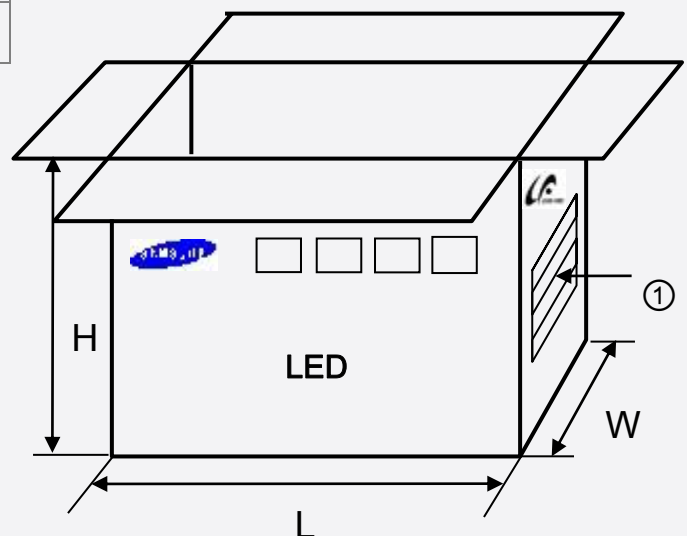
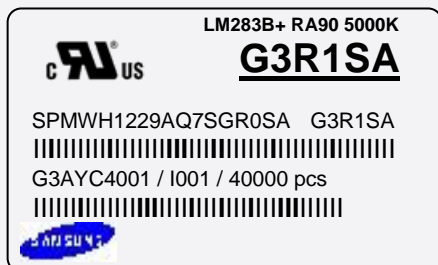

b) Packing Process (The quantity of PKG on the Reel to be Max 12,000 pcs)

Reel

LM283B+ RA90 5000K
G3R1SA
 SPMWH1229AQ7SKR0SA G3R1SA
 G3AYC4001 / IOAA / 12000 pcs
 SAMSUNG

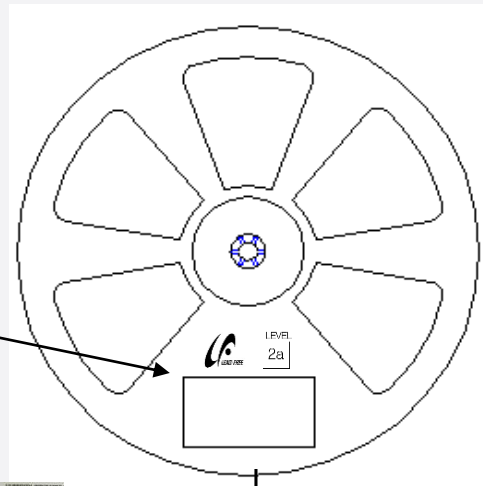

Aluminum Vinyl Packing Bag

LM283B+ RA90 5000K
G3R1SA
 SPMWH1229AQ7SKR0SA G3R1SA
 G3AYC4001 / IOAA / 12000 pcs
 SAMSUNG

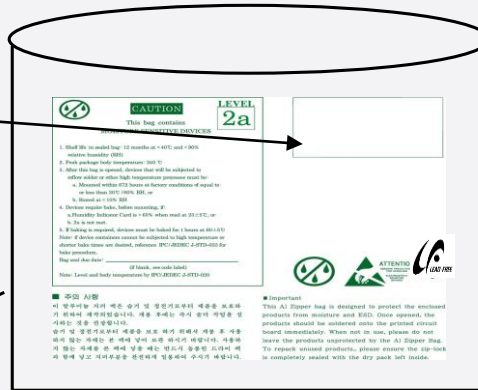

Outer Box

LM283B+ RA90 5000K
G3R1SA
 SPMWH1229AQ7SKR0SA G3R1SA
 G3AYC4001 / IOAA / 360000 pcs
 SAMSUNG

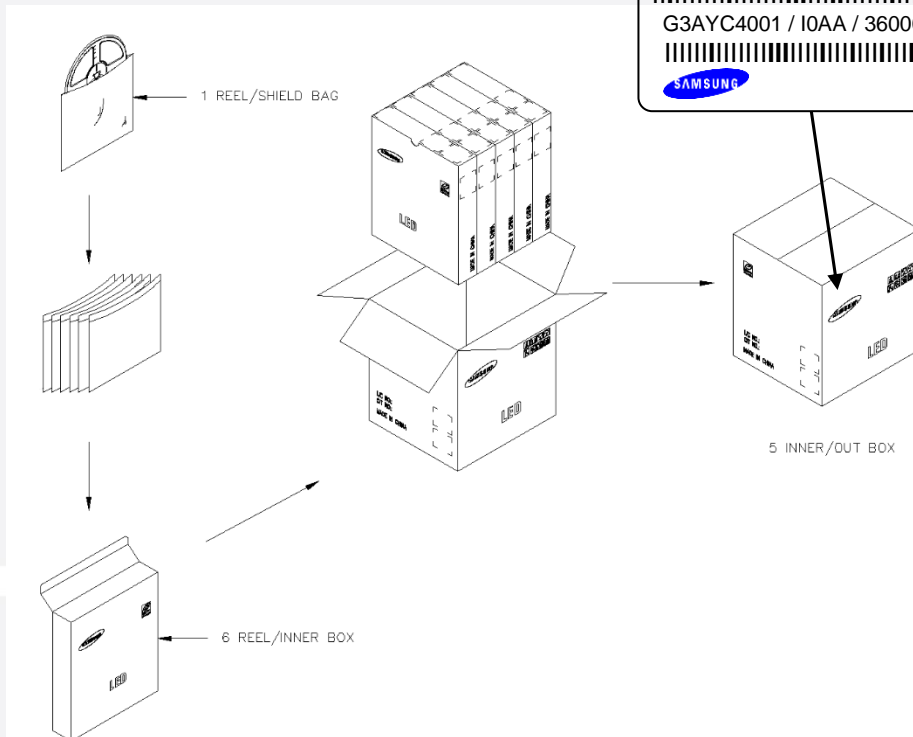

c) Packing Process

Reel

Kitting 'A'

LM283B+ RA90 ★K
G3★1SA
 SPMWH1229AQ7SG★KSA G3★1SA
 G3AW94001 / I0AA / 4000 pcs



Kitting 'B'

LM283B+ RA90 ★K
G3★CSA
 SPMWH1229AQ7SG★KSA G3★CSA
 G3AW94001 / I0AA / 4000 pcs

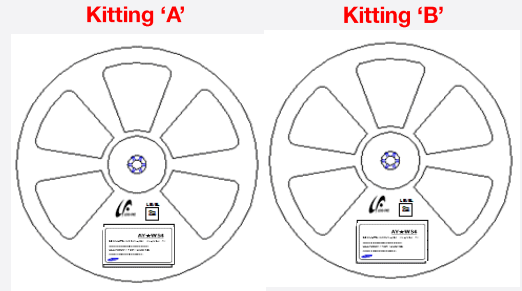
Aluminum Vinyl Packing Bag

Kitting 'A'

LM283B+ RA90 ★K
G3★1SA
 SPMWH1229AQ7SG★KSA G3★1SA
 G3AW94001 / I0AA / 4000 pcs



Kitting 'B'

LM283B+ RA90 ★K
G3★CSA
 SPMWH1229AQ7SG★KSA G3★CSA
 G3AW94001 / I0AA / 4000 pcs

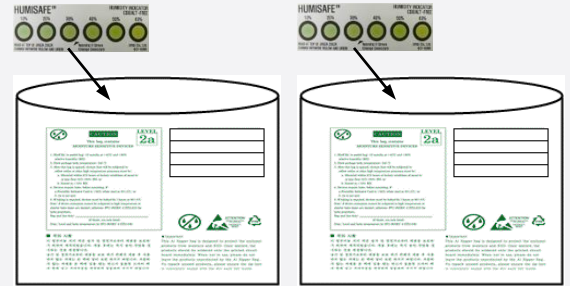
Outer Box

Kitting 'A'

LM283B+ RA90 ★K
G3★1SA
 SPMWH1229AQ7SG★KSA G3★1SA
 G3AW94001 / I0AA / 20000 pcs
 [BOX Label]



Kitting 'B'

LM283B+ RA90 ★K
G3★CSA
 SPMWH1229AQ7SG★KSA G3★CSA
 G3AW94001 / I0AA / 20000 pcs
 [BOX Label]

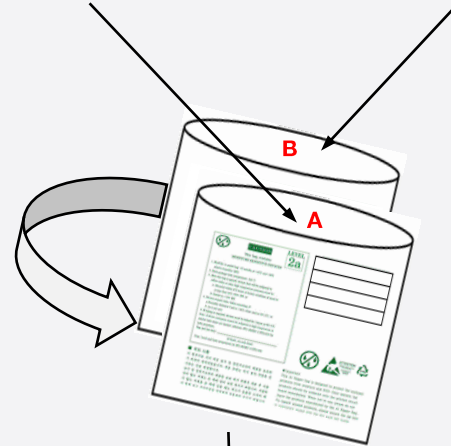

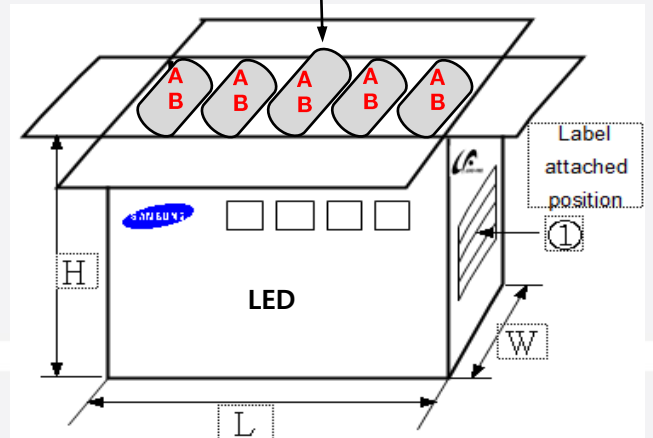

Material: Paper (SW3B(B))

| Type | Size (mm) | | | Note |
|-----------|-----------|---------|---------|----------------|
| | L | W | H | |
| 13 inch L | 345 ± 5 | 378 ± 5 | 405 ± 5 | Up to 10 reels |



c) Aluminum Vinyl Packing Bag



CAUTION

This bag contains
MOISTURE SENSITIVE DEVICE

LEVEL
2a

G2★ZS3

SPMWH1221FD5GB★KS0 G2★ZS3 01

G3AW94001 / 1001 / 4,000 pcs

1. Shelf life in sealed bag: 12 months at 30°C / 60% RH

2. Peak package body temperature: 140°C

3. After this bag is opened, devices that are subjected to reflow solder or other high temperature processes must be:

- a. Mounted within 672 hours at factory conditions of equal to or less than 30°C / 60% RH, or
- b. Stored at < 10% RH

4. Devices require bake, before mounting, if:

- a. Humidity Indicator Card is > 60% when read at 23±5°C, or
- b. 2a is not met.

5. If baking is required, devices must be baked for 10 ~ 24 hours at 60±5°C

Note: If device containers cannot be subjected to high temperature or shorter bake times are desired, reference IPC/JEDEC J-STD-033 for bake procedure.

Bag seal due date: _____
(If blank, see code label)

Note: Level and body temperature by IPC/JEDEC J-STD-020





LM283B+ RA90 5000K

cFL US **G3R1SA**

SPMWH1229AQ7SGR0SA G3R1SA

G3AYC4001 / I001 / 4,000 pcs



■ 주의 사항

이 알루미늄 지퍼 백은 습기 및 정전기로부터 제품을 보호하기 위하여 제작되었습니다. 개봉 후에는 즉시 솔더 작업을 실시하는 것을 권장합니다.

습기 및 정전기로부터 제품을 보호 하기 위해서 개봉 후 사용하지 않는 자재는 본 팩에 넣어 보관 하시기 바랍니다. 사용하지 않는 자재를 본 팩에 넣을 때는 반드시 동봉된 드라이 팩과 함께 넣고 지퍼부분을 완전하게 밀봉하여 주시기 바랍니다.

■ Important

This Al Zipper bag is designed to protect the enclosed products from moisture and ESD. Once opened, the products should be soldered onto the printed circuit board immediately. When not in use, please do not leave the products unprotected by the Al Zipper Bag. To repack unused products., please ensure the zip-lock is completely sealed with the dry pack left inside.

d) Humidity Indicator Card inside Aluminum Vinyl Bag

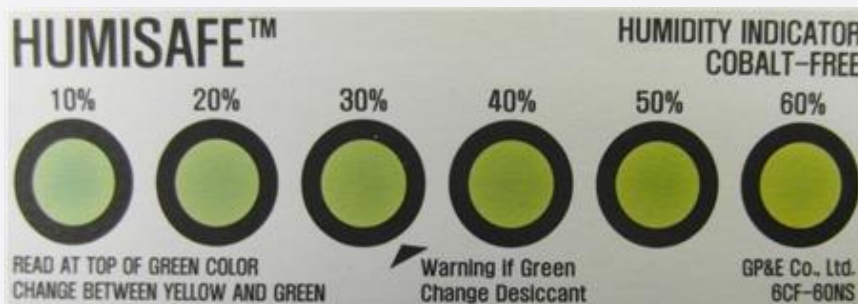

10. Precautions in Handling & Use

- 1) For over-current protection, users are recommended to apply resistors connected in series with the LEDs to mitigate sudden change of the forward current caused by shift of forward voltage.
- 2) This device should not be used in any type of fluid such as water, oil, organic solvent, etc. When cleaning is required, IPA is recommended as the cleaning agent. Some solvent-based cleaning agent may damage the silicone resins used in the device.
- 3) When the device is in operation, the forward current should be carefully determined considering the maximum ambient temperature and corresponding junction temperature.
- 4) LEDs must be stored in a clean environment. If the LEDs are to be stored for three months or more after being shipped from Samsung, they should be packed with a nitrogen-filled container (shelf life of sealed bags is 12 months at temperature 0~40 °C, 0~90 % RH).
- 5) After storage bag is opened, device subjected to soldering, solder reflow, or other high temperature processes must be:
 - a. Mounted within 672 hours (28 days) at an assembly line with a condition of no more than 30 °C / 60 % RH*^{Note 1}, or
 - b. Mounted within 24 hours (1 day) at an assembly line with a condition of more than 30 °C / 70 % RH*^{Note 2}, or
 - c. Stored at <10 % RH.

*Note 1, 2: IPC/JEDEC J-STD-033A, Recommended Equivalent Total Floor Life Table

| Package Type and Body Thickness | Moisture Sensitivity Level | Maximum Percent Relative Humidity | | | | | | Temperature |
|---------------------------------|----------------------------|-----------------------------------|-----|-----|-----|-----|-----|-------------|
| | | 40% | 50% | 60% | 70% | 80% | 90% | |
| Body Thickness <2.1mm | Level 2a | ∞ | ∞ | 28 | 1 | 1 | 1 | 30°C |
| | | ∞ | ∞ | ∞ | 2 | 1 | 1 | 25°C |
| | | ∞ | ∞ | ∞ | 2 | 2 | 1 | 20°C |

- 6) Repack unused devices with anti-moisture packing, fold to close any opening and then store in a dry place.
- 7) Devices require baking before mounting, if humidity card reading is >60 % at 23 ± 5 °C.
- 8) Devices must be baked for 10~24 hours at 60 ± 5 °C, if baking is required.
- 9) The LEDs are sensitive to the static electricity and surge current. It is recommended to use a wrist band or anti-electrostatic glove when handling the LEDs. If voltage exceeding the absolute maximum rating is applied to LEDs, it may cause damage or even destruction to LED devices. Damaged LEDs may show some unusual characteristics such as increase in leakage current, lowered turn-on voltage, or abnormal lighting of LEDs at low current.
- 10) VOCs (Volatile Organic Compounds) can be generated from adhesives, flux, hardener or organic additives used in luminaires (fixtures). Transparent LED silicone encapsulant is permeable to those chemicals and they may lead to a discoloration of encapsulant when they exposed to heat or light. This phenomenon can cause a significant loss of light emitted (output) from the luminaires. In order to prevent these problems, we recommend users to know the physical properties of materials used in luminaires and they must be carefully selected.
- 11) Risk of sulfurization (or tarnishing)

The LED from Samsung uses a silver-plated lead frame and its surface color may change to black (or dark colored) when it is exposed to sulfur (S), chlorine (Cl) or other halogen compound. Sulfurization of lead frame may cause intensity degradation, change of chromaticity coordinates and, in extreme cases, open circuit. It requires caution. Due to possible sulfurization of lead frame, LED should not be used and stored together with oxidizing substances made of materials such as rubber, plain paper, lead solder cream, etc.

Legal and additional information.

[About Samsung Electronics Co., Ltd.](#)

Samsung Electronics Co., Ltd. is a global leader in technology, opening new possibilities for people everywhere. Through relentless innovation and discovery, we are transforming the worlds of TVs, smartphones, tablets, PCs, cameras, home appliances, printers, LTE systems, medical devices, semiconductors and LED solutions. We employ 286,000 people across 80 countries with annual sales of US\$216.7 billion. To discover more, please visit www.samsungled.com.

Copyright © 2018 Samsung Electronics Co., Ltd. All rights reserved.
Samsung is a registered trademark of Samsung Electronics Co., Ltd.
Specifications and designs are subject to change without notice. Non-metric weights and measurements are approximate. All data were deemed correct at time of creation. Samsung is not liable for errors or omissions. All brand, product, service names and logos are trademarks and/or registered trademarks of their respective owners and are hereby recognized and acknowledged.

Samsung Electronics Co., Ltd.
95, Samsung 2-ro
Giheung-gu
Yongin-si, Gyeonggi-do, 446-711
KOREA

www.samsungled.com

