

## DESCRIPTION

The MP2639A is a highly integrated, flexible, switch-mode, battery-charging management device for 2-cell series Li-ion and Li-polymer batteries used in a wide range of portable applications.

The MP2639A is able to charge a 2-cell battery from a 5V adapter or USB input. The MP2639A can work in three modes: charge mode, discharge mode, and sleep mode.

In 2-cell applications, the 5V input charges the 2-cell battery via the MP2639A operating in step-up mode. When the 5V input is absent, the 2-cell battery voltage is discharged to the 5V output via the MP2639A working in step-down mode.

For the charging function, the MP2639A detects the battery voltage automatically and charges the battery in three phases: trickle current, constant current, and constant voltage. Other features include charge termination and auto-recharge.

To guarantee safe operation, the MP2639A limits the die temperature to a preset value of 120°C. Other safety features include input over-voltage protection (OVP), battery over-voltage protection (OVP), thermal shutdown, battery temperature monitoring, and a programmable timer to prevent prolonged charging of a dead battery.

The MP2639A is available in a QFN-26 (4mmx4mm) package.

## FEATURES

- 4.0V to 5.75V Input Voltage Range
- Charge 2-Cell Batteries with 5V Input
- USB-Compliant Charger
- Integrates Input Current-Based and Input Voltage-Based Power Management Functions
- Programmable Input Current and Input Voltage Limit
- Up to 2.5A Programmable Charge Current for 2-Cell Applications
- 8.4V Charge Voltage with 0.5% Accuracy
- Up to 5.0A Programmable Discharge Current
- Negative Temperature Coefficient Pin for Temperature Monitoring
- No Load Shutdown and Push Button Turn-On in Discharge Mode
- Programmable Timer Back-Up Protection
- Discharge Mode Load Trace Compensation
- Thermal Regulation and Thermal Shutdown
- Internal Battery Reverse Leakage Blocking
- Integrated Short-Circuit Protection (SCP) for Both Charge and Discharge Mode
- Four LED Battery Level and Status Indicators
- Available in a QFN-26 (4mmx4mm) Package

## APPLICATIONS

- Power Station Applications
- Power Bank Applications for Smart Phones, Tablets, and Other Portable Devices
- Mobile Internet Devices

All MPS parts are lead-free, halogen-free, and adhere to the RoHS directive. For MPS green status, please visit the MPS website under Quality Assurance. "MPS" and "The Future of Analog IC Technology" are registered trademarks of Monolithic Power Systems, Inc.

## TYPICAL APPLICATION

### 2-Cell Application – Charge Mode

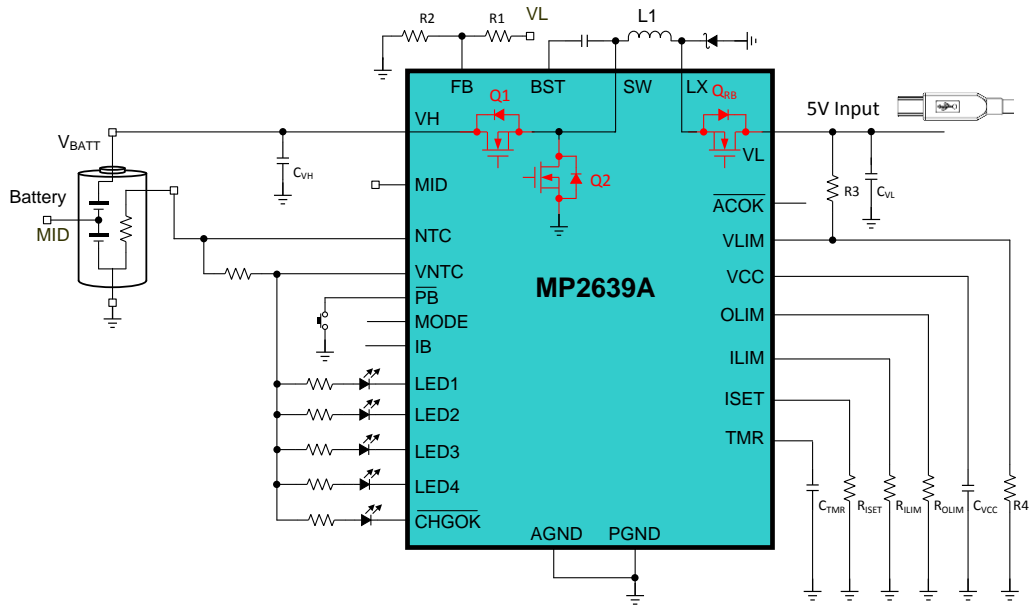

### 2-Cell Application – Discharge Mode

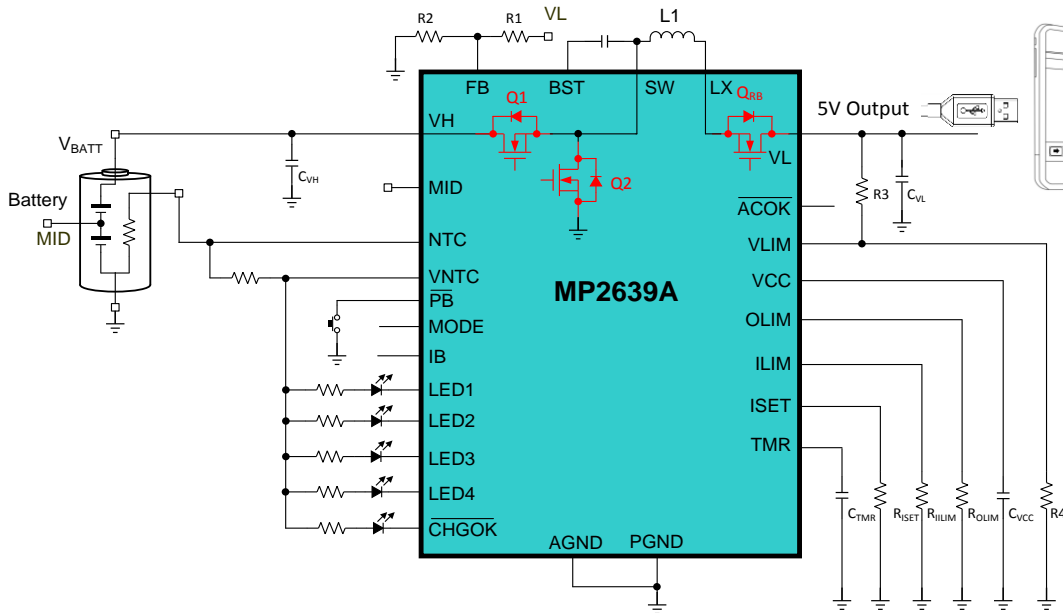

| Adapter Term | BATT Term | MODE | CHG/DSG | Active SW | Topology  |
|--------------|-----------|------|---------|-----------|-----------|
| VL           | VH        | High | DSG     | Q1        | Step-down |
|              |           | Low  | CHG     | Q2        | Step-up   |

### ORDERING INFORMATION

| Part Number* | Package          | Top Marking |
|--------------|------------------|-------------|
| MP2639AGR    | QFN-26 (4mmx4mm) | See Below   |

\* For Tape & Reel, add suffix -Z (e.g. MP2639AGR-Z)

### TOP MARKING

**MPSYWW**  
**M2639A**  
**LLLLLL**

MPS: MPS prefix  
 Y: Year code  
 WW: Week code  
 M2639A: Product code of MP2639AGR  
 LLLLLL: Lot number

### PACKAGE REFERENCE

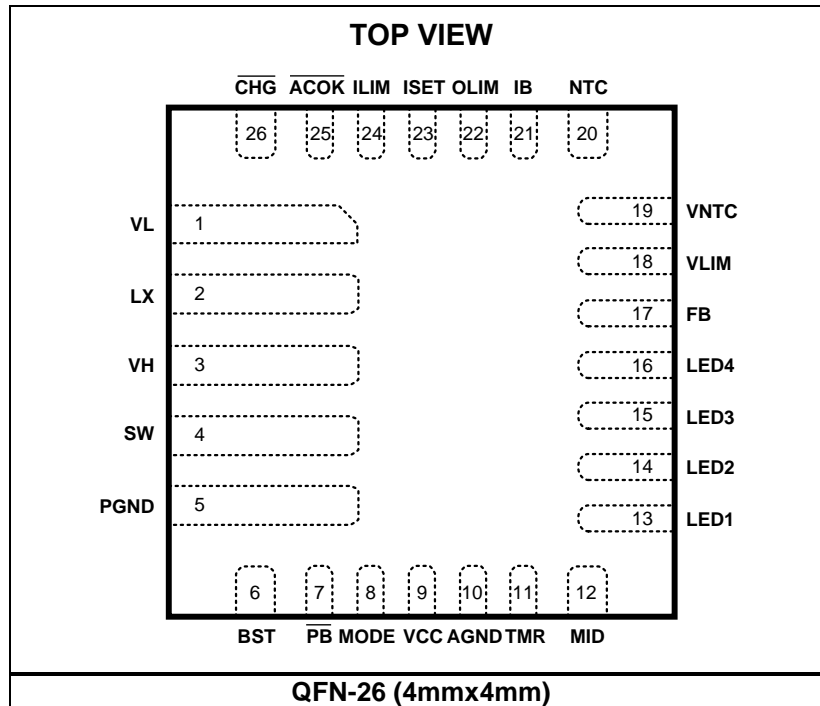

**ABSOLUTE MAXIMUM RATINGS** <sup>(1)</sup>

|  |                              |
|--|------------------------------|
| VH .....   | -0.3V to +20V                |
| SW.....  | -0.3V (-2V for 50ns) to +20V |
| VL.....  | -0.3V to +16V                |
| MID.....   | -0.3V to +12V                |
| BST to SW.....   | -0.3V to +5.5V               |
| All other pins to GND .....  | -0.3V to +5.5V               |
| Continuous power dissipation (T <sub>A</sub> = +25°C) <sup>(2)</sup> | .....2.97W                   |
| Junction temperature .....   | 150°C                        |
| Lead temperature (solder) .....                                      | 260°C                        |
| Storage temperature.....   | -65°C to +150°C              |

**Recommended Operating Conditions** <sup>(3)</sup>

|  |                 |
|--|-----------------|
| VL to GND .....                                | 4V to 5.5V      |
| VH to GND.....                                 | 6V to 8.7V      |
| Operating junction temp. (T <sub>J</sub> ) ... | -40°C to +125°C |

|  |                       |                       |
|--|-----------------------|-----------------------|
| <b>Thermal Resistance</b> <sup>(4)</sup> | <b>θ<sub>JA</sub></b> | <b>θ<sub>JC</sub></b> |
| QFN-26 (4mmx4mm) .....                   | 42.....               | 9 .... °C/W           |

**NOTES:**

- 1) Exceeding these ratings may damage the device.
- 2) The maximum allowable power dissipation is a function of the maximum junction temperature T<sub>J</sub> (MAX), the junction-to-ambient thermal resistance θ<sub>JA</sub>, and the ambient temperature T<sub>A</sub>. The maximum allowable continuous power dissipation at any ambient temperature is calculated by P<sub>D</sub> (MAX) = (T<sub>J</sub> (MAX)-T<sub>A</sub>)/θ<sub>JA</sub>. Exceeding the maximum allowable power dissipation produces an excessive die temperature, causing the regulator to go into thermal shutdown. Internal thermal shutdown circuitry protects the device from permanent damage.
- 3) The device is not guaranteed to function outside of its operating conditions.
- 4) Measured on JESD51-7, 4-layer PCB.

## ELECTRICAL CHARACTERISTICS

$V_{IN} = V_L = 5V$ ,  $T_A = 25^{\circ}C$ , unless otherwise noted.

| Parameter                                       | Symbol           | Condition                               | Min  | Typ   | Max  | Units      |
|---|------------------|---|------|-------|------|------------|
| <b>DC/DC Parameter</b>                          |                  |   |      |       |      |            |
| LV side input over-voltage threshold            | $V_{LOVP}$       | VL rising until the switching is off    |      | 5.75  |      | V          |
| LV side input over-voltage threshold hysteresis |                  |   |      | 200   |      | mV         |
| VCC LDO output                                  | $V_{CC}$         | MODE = high, $V_H = 7.6V$               | 4.4  | 4.5   | 4.6  | V          |
|   |                  | MODE = low, $V_H = 0V$ , $V_L = 5V$     |      | 4.5   |      | V          |
| Input power good threshold                      | $V_{UVLO}$       | VL rising                               |      | 3.9   |      | V          |
|   |                  | VL falling                              |      | 3.6   |      |            |
| High-side NMOS on resistance                    | $Q_{1\_ON}$      | $T_A = 25^{\circ}C$                     |      | 19    |      | m $\Omega$ |
|   |                  | $T_A = -40^{\circ}C$ to $+85^{\circ}C$  |      | 19    | 29   |            |
| Low-side NMOS on resistance                     | $Q_{2\_ON}$      | $T_A = 25^{\circ}C$                     |      | 24    |      | m $\Omega$ |
|   |                  | $T_A = -40^{\circ}C$ to $+85^{\circ}C$  |      | 24    | 36   |            |
| Reverse blocking NMOS on resistance             | $Q_{BR\_ON}$     | $T_A = 25^{\circ}C$                     |      | 10    |      | m $\Omega$ |
|   |                  | $T_A = -40^{\circ}C$ to $+125^{\circ}C$ |      | 10    | 15   |            |
| Peak current limit for high-side NMOS           |                  | Step-down mode                          | 6    | 8     | 10   | A          |
| Peak current limit for low-side NMOS            |                  | Step-up CC mode                         | 7    | 9     |      | A          |
|   |                  | Step-up TC mode                         | 3    | 4     |      | A          |
| Operating frequency                             | $F_{SW}$         |   |      | 1300  |      | kHz        |
| <b>Charging Operation</b>                       |                  |   |      |       |      |            |
| Input quiescent current                         | $I_{IN}$         | Battery float, charging is enabled      |      |       | 2.5  | mA         |
| Trickle charge threshold                        | $V_{BATT\_TC}$   | $V_{BATT}$ rising                       |      | 5.9   |      | V          |
| Trickle charge threshold hysteresis             |                  | $V_{BATT}$ falling                      |      | 240   |      | mV         |
| Trickle input current                           | $I_{TC}$         |   |      | 300   |      | mA         |
| Constant fast charge current                    | $I_{CC}$         | $R_{ISET} = 215k\Omega$                 | 794  | 992   | 1191 | mA         |
|   |                  | $R_{ISET} = 86.6k\Omega$                | 2.2  | 2.46  | 2.7  | A          |
| Termination charge current                      | $I_{BF}$         | As the percentage of $I_{CC}$           | 2.5  | 10    | 17.5 | %          |
|   |                  | If $10\% * I_{CC} < 167mA$              | 38   | 150   |      | mA         |
| Input voltage clamp reference                   | $V_{IN\_CIAMP}$  |   | 1.18 | 1.2   | 1.22 | V          |
| Input current limit                             | $I_{IN\_LMT}$    | $R_{ILIM} = 475k\Omega$                 | 400  | 449   | 500  | mA         |
|   |                  | $R_{ILIM} = 261k\Omega$                 | 720  | 817   | 900  | mA         |
|   |                  | $R_{ILIM} = 78.7k\Omega$                | 2.56 | 2.71  | 3    | A          |
| Termination charge voltage                      | $V_{BATT\_FULL}$ |   | 8.35 | 8.38  | 8.41 | V          |
| Auto-recharge threshold                         |                  |   |      | 8.00  |      | V          |
| Battery over-voltage threshold                  | $V_{BATT\_OV}$   | As the percentage of $V_{BATT\_FULL}$   | 101  | 103.3 | 105  | %          |

**ELECTRICAL CHARACTERISTICS** *(continued)*
 $V_{IN} = V_L = 5V$ ,  $T_A = 25^\circ C$ , unless otherwise noted.

| Parameter                                | Symbol           | Condition  | Min  | Typ  | Max  | Units   |
|--|------------------|--|------|------|------|---------|
| <b>Discharge Operation</b>               |                  |  |      |      |      |         |
| Output voltage range                     |                  | $I_{OUT} = 0A$                                     | 4.5  |      | 5.5  | V       |
| Feedback voltage                         |                  |  | 1.18 | 1.2  | 1.22 | V       |
| Feedback input current                   |                  | $V_{FB} = 1.2V$                                    |      |      | 300  | nA      |
| Output over-voltage threshold            |                  |  | 5.6  | 5.75 | 6.0  | V       |
| Output over-voltage threshold hysteresis |                  |  |      | 160  |      | mV      |
| Shutdown current                         |                  | Discharging is disabled                            |      |      | 20   | $\mu A$ |
| Programmable output current limit        | $I_{OUT\_LIMIT}$ | $R_{OLIM} = 86.6k\Omega$                           | 2.2  | 2.46 | 2.7  | A       |
|  |                  | $R_{OLIM} = 71.5k\Omega$                           | 2.77 | 2.98 | 3.19 |         |
|  |                  | $R_{OLIM} = 44.2k\Omega$                           | 4.49 | 4.83 | 5.17 |         |
| Battery UV threshold                     | $V_{BATTUV}$     | Rising   |      | 6.28 |      | V       |
|  |                  | Falling  |      | 5.75 |      | V       |
| ACOK, CHG output low voltage             |                  | Sinking 1.5mA                                      |      |      | 400  | mV      |
| ACOK, CHG leakage current                |                  | Connected to 5V                                    |      |      | 1    | $\mu A$ |
| LED blinking frequency                   |                  | $C_{TMR} = 0.1\mu F$ , $I_{CHG} = 1A$              |      | 1    |      | Hz      |
| EN, MODE input logic low voltage         |                  |  |      |      | 0.4  | V       |
| EN, MODE input high voltage              |                  |  | 1.4  |      |      | V       |
| IB voltage output                        |                  | $I_{CHG} = 1A$ in charge mode                      |      | 0.38 |      | V       |
|  |                  | $I_{DIS} = 1A$ in discharge mode                   |      | 0.42 |      | V       |
| Trickle charge time                      |                  | $C_{TMR} = 0.1\mu F$ , stay in TC mode, $I_L = 1A$ |      | 30   |      | mins    |
| Total current charge time                |                  | $C_{TMR} = 0.1\mu F$ , $I_L = 1A$                  |      | 5.4  |      | hours   |

**ELECTRICAL CHARACTERISTICS** *(continued)*
 $V_{IN} = V_L = 5V$ ,  $T_A = 25^\circ C$ , unless otherwise noted.

| Parameter                                  | Symbol       | Condition                   | Min  | Typ  | Max  | Units |
|--|--------------|-----------------------------|------|------|------|-------|
| <b>Protection</b>                          |              |                             |      |      |      |       |
| NTC low temp rising threshold              | $V_{COLD}$   | As percentage of $V_{VREF}$ | 69.3 | 69.9 | 70.5 | %     |
| NTC low temp rising threshold hysteresis   |              | As percentage of $V_{VREF}$ |      | 0.8  |      | %     |
| NTC cool temp rising threshold             | $V_{COOL}$   | As percentage of $V_{VREF}$ | 67.2 | 67.8 | 68.4 | %     |
| NTC cool temp rising threshold hysteresis  |              | As percentage of $V_{VREF}$ |      | 1.2  |      | %     |
| NTC warm temp falling threshold            | $V_{WARM}$   | As percentage of $V_{VREF}$ | 54.7 | 55.3 | 55.9 | %     |
| NTC warm temp falling threshold hysteresis |              | As percentage of $V_{VREF}$ |      | 1.5  |      | %     |
| NTC hot temp falling threshold             | $V_{HOT}$    | As percentage of $V_{VREF}$ | 46.9 | 47.4 | 47.9 | %     |
| NTC hot temp falling threshold hysteresis  |              | As percentage of $V_{VREF}$ |      | 1.5  |      | %     |
| No load shutdown delay time                | $t_{NOLOAD}$ |                             |      | 20   |      | s     |
| No load shutdown current threshold         | $I_{NOLOAD}$ |                             |      | 50   |      | mA    |
| Threshold between long and short touch     |              |                             |      | 2.5  |      | s     |
| LED auto-off timer delay                   |              |                             |      | 5    |      | s     |
| <b>Voltage-Based Fuel Gauge</b>            |              |                             |      |      |      |       |
| <b>Charge Mode</b>                         |              |                             |      |      |      |       |
| First level of battery voltage threshold   |              | Battery voltage rising      |      | 7.35 |      | V     |
| Hysteresis                                 |              |                             |      | 400  |      | mV    |
| Second level of battery voltage threshold  |              | Battery voltage rising      |      | 7.75 |      | V     |
| Hysteresis                                 |              |                             |      | 400  |      | mV    |
| Third level of battery voltage threshold   |              | Battery voltage rising      |      | 8.15 |      | V     |
| Hysteresis                                 |              |                             |      | 400  |      | mV    |

**ELECTRICAL CHARACTERISTICS** (continued)

$V_{IN} = V_L = 5V$ ,  $T_A = 25^\circ C$ , unless otherwise noted.

| Parameter                                   | Symbol            | Condition               | Min | Typ | Max | Units    |
|---|-------------------|-------------------------|-----|-----|-----|----------|
| <b>Discharge Mode</b>                       |                   |                         |     |     |     |          |
| Fourth level of battery voltage threshold   |                   | Battery voltage falling |     | 8   |     | V        |
| Hysteresis                                  |                   |                         |     | 400 |     | mV       |
| Third level of battery voltage threshold    |                   | Battery voltage falling |     | 7.6 |     | V        |
| Hysteresis                                  |                   |                         |     | 400 |     | mV       |
| Second level of battery voltage             |                   | Battery voltage falling |     | 7.2 |     | V        |
| Hysteresis                                  |                   |                         |     | 400 |     | mV       |
| First level of battery voltage              |                   | Battery voltage falling |     | 6   |     | V        |
| Hysteresis                                  |                   |                         |     | 400 |     | mV       |
| <b>Cell Balancing</b>                       |                   |                         |     |     |     |          |
| Discharge MOSFET on resistance              | HS                |                         |     | 6   |     | $\Omega$ |
|   | LS                |                         |     | 6   |     |          |
| Cell balance start voltage                  | $V_{CBST}$        |                         | 3.4 | 3.5 | 3.6 | V        |
| Balance threshold                           | $\Delta V_{CELL}$ |                         |     | 65  |     | mV       |
| Balance threshold hysteresis <sup>(5)</sup> |                   |                         |     | 30  |     | mV       |

**NOTE:**

5) Guaranteed by design.



**TYPICAL PERFORMANCE CHARACTERISTICS**

$V_{IN} = V_L = 5V$ ,  $V_{BATT} = V_H = 7.4V$ ,  $C_{VL} = C_{VH} = 22\mu F$ ,  $L1 = 2.2\mu H$ ,  $C_{TMR} = 0.1\mu F$ ,  $R1 = 76.8k\Omega$ ,  $R2 = 24.3k\Omega$ ,  $R3 = 27.4k\Omega$ ,  $R4 = 10k\Omega$ , battery simulator, unless otherwise noted.

**Constant Current Charge Efficiency**

$V_L=5V$ ,  $V_H=6$  to  $8.4V$ ,  $R_{ILIM}=0\Omega$ ,  $R_{ISET}=86.6k\Omega$

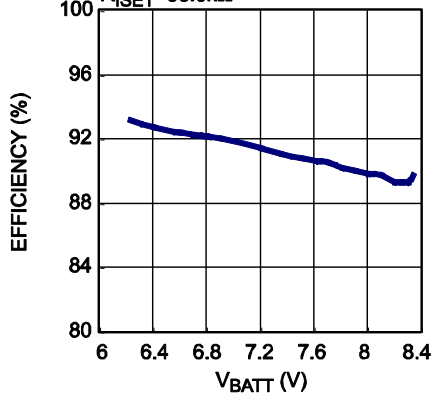

**Constant Voltage Charge Efficiency**

$V_L=5V$ ,  $V_H=8.4V$ ,  $R_{ILIM}=0\Omega$ ,  $R_{ISET}=86.6k\Omega$

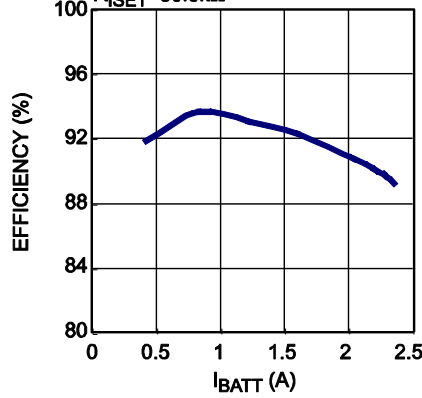

**Efficiency @ Discharge Mode**

$V_L=5V$ ,  $V_H=7.4V$ ,  $R_{OLIM}=0\Omega$ ,  $I_{LOAD}=0-5A$

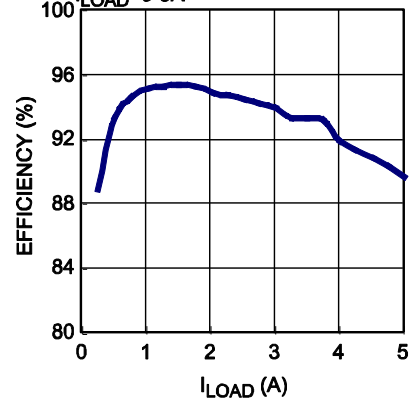

**Programmable Charge Current, Charge Mode**

$V_L=5V$ ,  $V_H=6.6V$

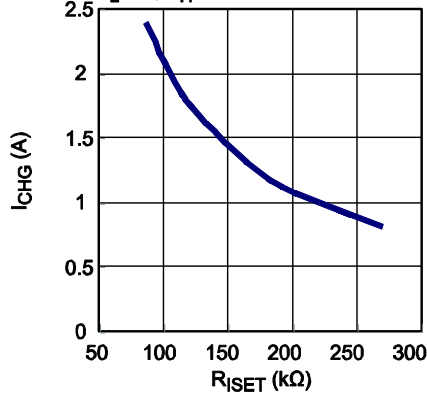

**Programmable Input Current Limit, Charge Mode**

$V_L=5V$ ,  $V_H=8.4V$

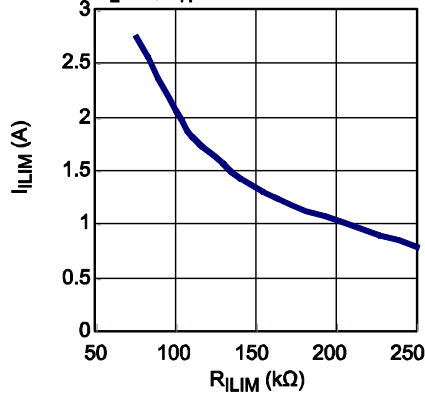

**Programmable Output Current Limit, Discharge Mode**

$V_L=5V$ ,  $V_H=8.4V$

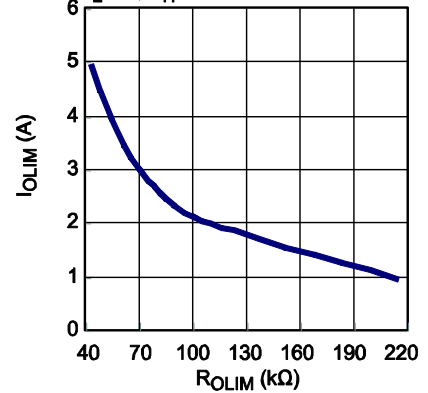

**I<sub>B</sub> Curve, Charge Mode**

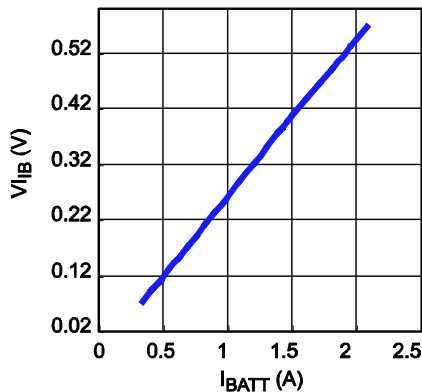

**BATT\_Full Voltage vs. Temperature**

$V_L=5V$ , MODE=LOW

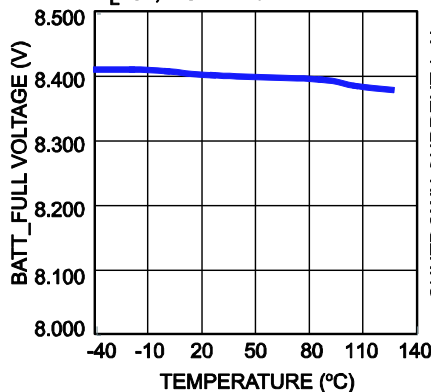

**Shutdown Current vs. Temperature**

MODE= $V_H=8.4V$

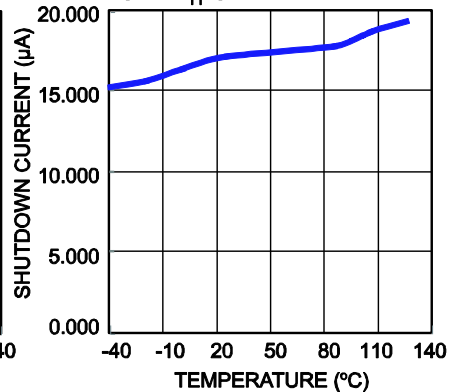

**TYPICAL PERFORMANCE CHARACTERISTICS** (continued)

$V_{IN} = V_L = 5V$ ,  $V_{BATT} = V_H = 7.4V$ ,  $C_{VL} = C_{VH} = 22\mu F$ ,  $L1 = 2.2\mu H$ ,  $C_{TMR} = 0.1\mu F$ ,  $R1 = 76.8k\Omega$ ,  $R2 = 24.3k\Omega$ ,  $R3 = 27.4k\Omega$ ,  $R4 = 10k\Omega$ , battery simulator, unless otherwise noted.

**Battery Charge Curve**

$V_{BATT\_FULL} = 8.4V$ ,  $R_{ILIM} = 0\Omega$ ,  $R_{ISET} = 86.6k\Omega$

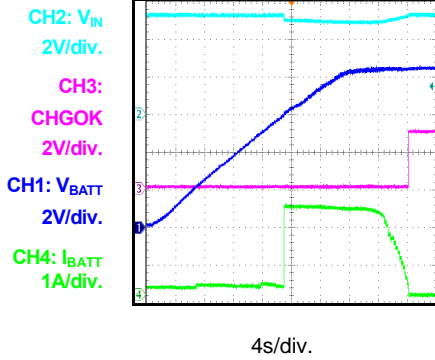

**Auto-Recharge**

$V_{BATT\_FULL} = 8.4V$ ,  $R_{ILIM} = 0\Omega$ ,  $R_{ISET} = 86.6k\Omega$

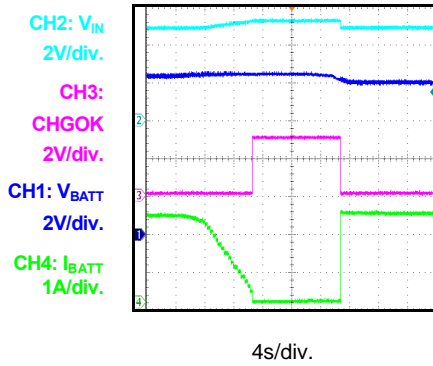

**LED Indication during Charging**

$V_{BATT\_FULL} = 8.4V$ ,  $R_{ILIM} = 0\Omega$ ,  $R_{ISET} = 86.6k\Omega$ ,  $V_{BATT\_OFFSET} = 6V$

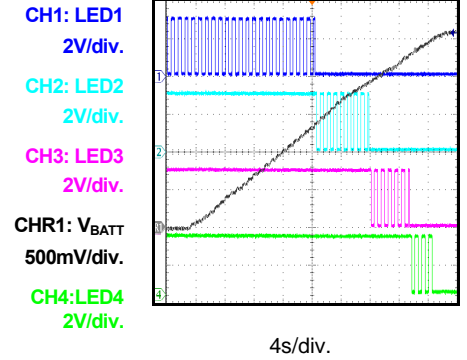

**Battery Charge Curve**

$V_{BATT\_FULL} = 8.4V$ ,  $R_{ILIM} = 73.2k\Omega$ ,  $R_{ISET} = 86.6k\Omega$

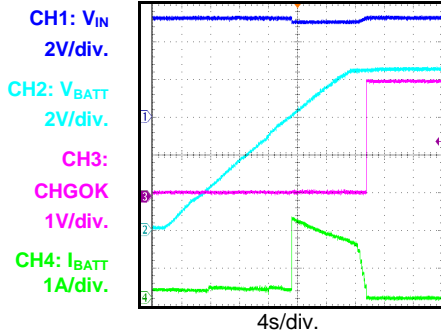

**TC Charge Steady State**

$V_{BATT} = 5.0V$ ,  $R_{ILIM} = 73.2k\Omega$ ,  $R_{ISET} = 86.6k\Omega$

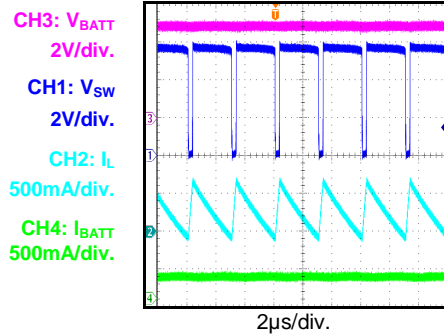

**TC Charge Steady State @  $V_H = V_L - 1V$**

$V_{BATT} = 4.0V$ ,  $R_{ILIM} = 73.2k\Omega$ ,  $R_{ISET} = 86.6k\Omega$

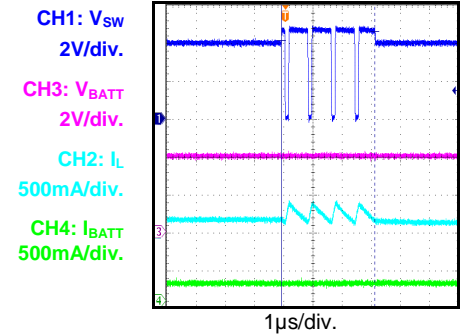

**CC Charge Steady State**

$V_{BATT} = 6.6V$ ,  $R_{ILIM} = 73.2k\Omega$ ,  $R_{ISET} = 86.6k\Omega$

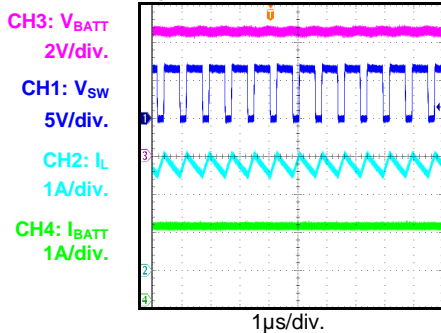

**CV Charge Steady State**

$V_{BATT} = 8.4V$ ,  $R_{ILIM} = 73.2k\Omega$ ,  $R_{ISET} = 86.6k\Omega$

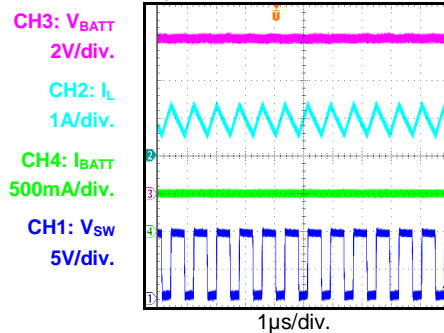

**TYPICAL PERFORMANCE CHARACTERISTICS** (continued)

$V_{IN} = V_L = 5V$ ,  $V_{BATT} = V_H = 7.4V$ ,  $C_{VL} = C_{VH} = 22\mu F$ ,  $L1 = 2.2\mu H$ ,  $C_{TMR} = 0.1\mu F$ ,  $R1 = 76.8k\Omega$ ,  $R2 = 24.3k\Omega$ ,  $R3 = 27.4k\Omega$ ,  $R4 = 10k\Omega$ , battery simulator, unless otherwise noted.

**Power On, TC Charge Mode**

$V_{BATT} = 4.0V$ ,  $R_{LIM} = 73.2k\Omega$ ,  $R_{ISET} = 86.6k\Omega$

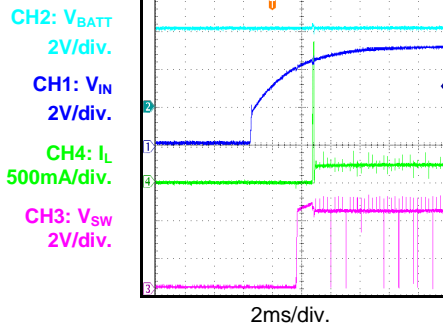

**Power On, CC Charge Mode**

$V_{BATT} = 6.6V$ ,  $R_{LIM} = 73.2k\Omega$ ,  $R_{ISET} = 86.6k\Omega$

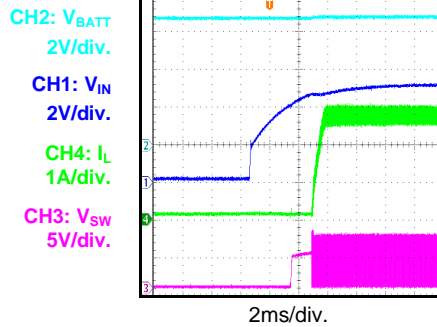

**Power Off, CC Charge Mode**

$V_{BATT} = 6.6V$ ,  $R_{LIM} = 73.2k\Omega$ ,  $R_{ISET} = 86.6k\Omega$

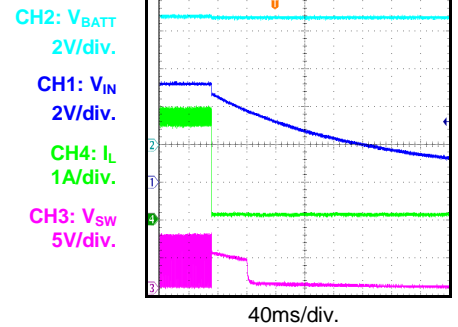

**Input Current Limit**

$V_{IN} = 5.0V$ ,  $R_{LIM} = 75k\Omega$ ,  $R_{ISET} = 100k\Omega$

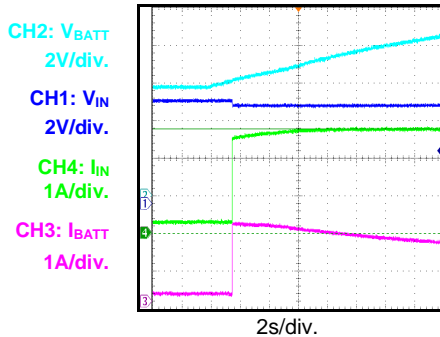

**Input Voltage Regulation**

$V_{IN} = 5.0V/4A$ ,  $V_{IN\_REG} = 4.49V$

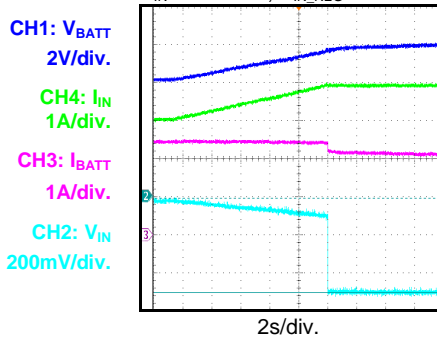

**Mode On, CC Mode**

$V_{BATT} = 6.6V$ ,  $R_{LIM} = 73.2k\Omega$ ,  $R_{ISET} = 86.6k\Omega$

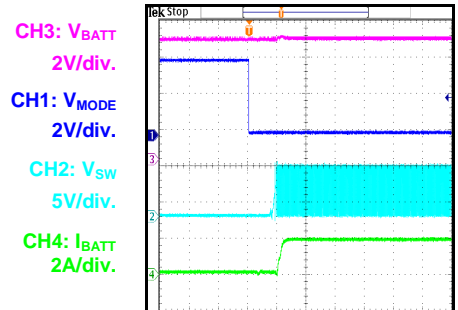

**Mode Off, CC Mode**

$V_{BATT} = 6.6V$ ,  $R_{LIM} = 73.2k\Omega$ ,  $R_{ISET} = 86.6k\Omega$

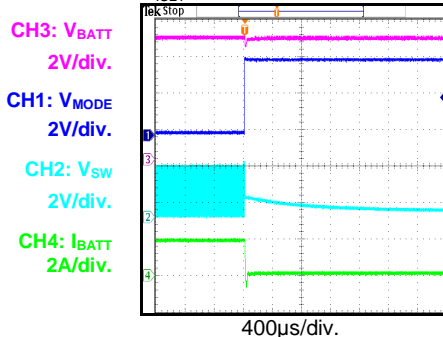

**Mode On, CV Mode**

$V_{BATT} = 8.4V$ ,  $R_{LIM} = 73.2k\Omega$ ,  $R_{ISET} = 86.6k\Omega$

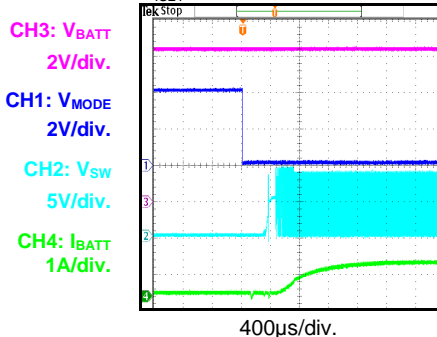

**TYPICAL PERFORMANCE CHARACTERISTICS (continued)**

$V_{IN} = V_L = 5V$ ,  $V_{BATT} = V_H = 7.4V$ ,  $C_{VL} = C_{VH} = 22\mu F$ ,  $L1 = 2.2\mu H$ ,  $C_{TMR} = 0.1\mu F$ ,  $R1 = 76.8k\Omega$ ,  $R2 = 24.3k\Omega$ ,  $R3 = 27.4k\Omega$ ,  $R4 = 10k\Omega$ , battery simulator, unless otherwise noted.

**NTC Protection, TC Mode**

$V_{BATT} = 5.6V$ ,  $R_{ILIM} = 73.2k\Omega$ ,  $R_{ISET} = 86.6k\Omega$

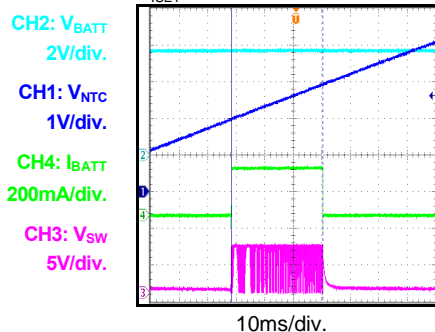

**NTC Protection, CC Mode**

$V_{BATT} = 7.4V$ ,  $R_{ILIM} = 73.2k\Omega$ ,  $R_{ISET} = 86.6k\Omega$

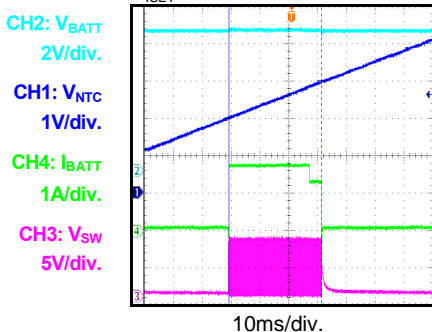

**NTC Protection, CC Mode**

$V_{BATT} = 8.15V$ ,  $R_{ILIM} = 73.2k\Omega$ ,  $R_{ISET} = 86.6k\Omega$

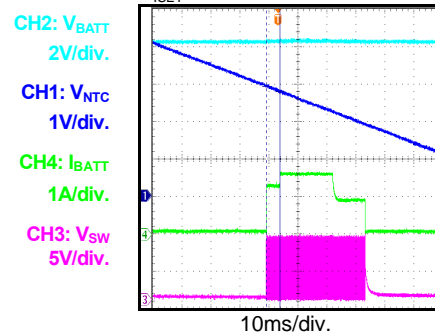

**Timer Out Protection**

$V_{BATT} = 7.4V$ ,  $R_{ILIM} = 73.2k\Omega$ ,  $R_{ISET} = 86.6k\Omega$ ,  $C_{TMR} = 220pF$

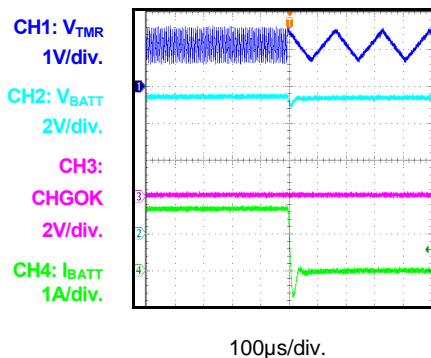

**Recovery from Timer Out**

$V_{BATT} = 7.4V$ ,  $R_{ILIM} = 73.2k\Omega$ ,  $R_{ISET} = 86.6k\Omega$ ,  $C_{TMR} = 220pF$

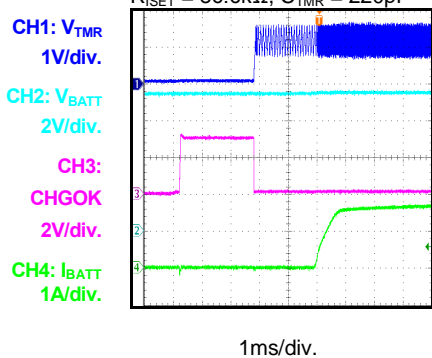

**Timer Period**

$V_{BATT} = 7.4V$ ,  $R_{ILIM} = 73.2k\Omega$ ,  $R_{ISET} = 86.6k\Omega$ ,  $C_{TMR} = 220pF$

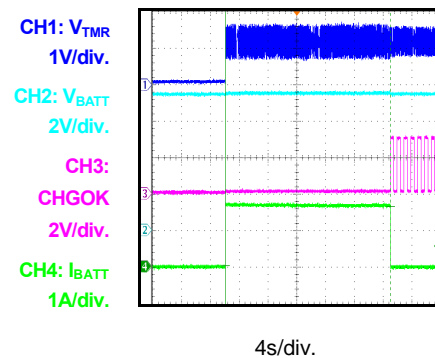

**Indication @ BATT OVP**

$V_{BATT} = 9.0V$ ,  $R_{ILIM} = 73.2k\Omega$ ,  $R_{ISET} = 86.6k\Omega$

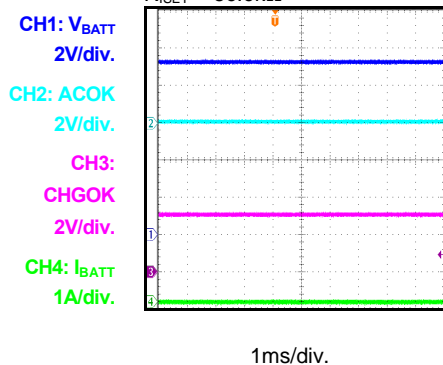

**Indication @ Charge Mode Off**

$V_{BATT} = 7.4V$ ,  $R_{ILIM} = 73.2k\Omega$ ,  $R_{ISET} = 86.6k\Omega$

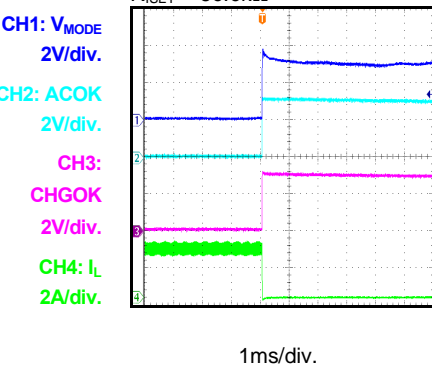

**Indication @ NTC Fault**

$V_{BATT} = 3.7V$ ,  $R_{ILIM} = 14.7k\Omega$ ,  $R_{ISET} = 49.9k\Omega$

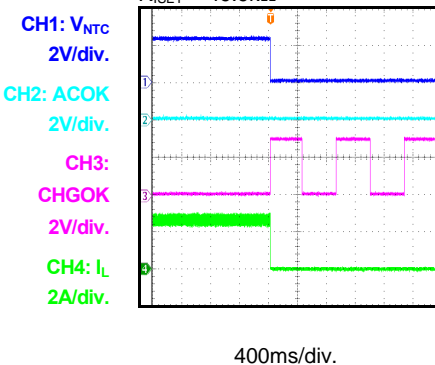

**TYPICAL PERFORMANCE CHARACTERISTICS** (continued)

$V_{IN} = V_L = 5V$ ,  $V_{BATT} = V_H = 7.4V$ ,  $C_{VL} = C_{VH} = 22\mu F$ ,  $L1 = 2.2\mu H$ ,  $C_{TMR} = 0.1\mu F$ ,  $R1 = 76.8k\Omega$ ,  $R2 = 24.3k\Omega$ ,  $R3 = 27.4k\Omega$ ,  $R4 = 10k\Omega$ , battery simulator, unless otherwise noted.

**Discharge Mode  
Steady State**

$V_{BATT} = 7.4V$ ,  $I_{LOAD} = 5A$

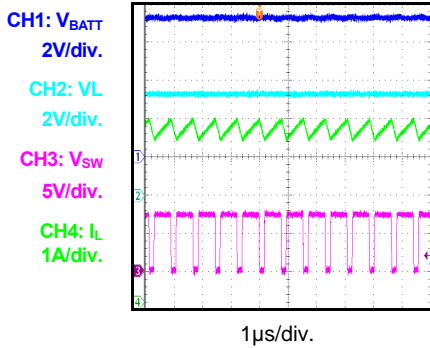

**No Load Shutdown,  
Discharge Mode**

$V_{BATT} = 7.4V$ ,  $I_{LOAD} = 0A$

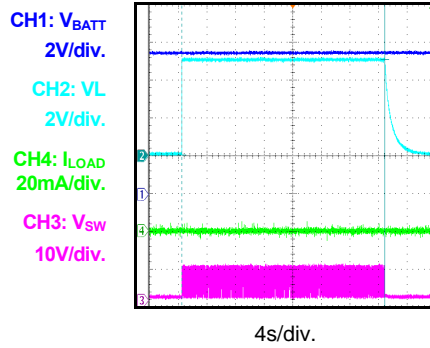

**Weak Battery  
Protection,  
Discharge Mode**

$I_{LOAD} = 1.5A$ ,  $V_{BATT\_OFFSET} = 5V$

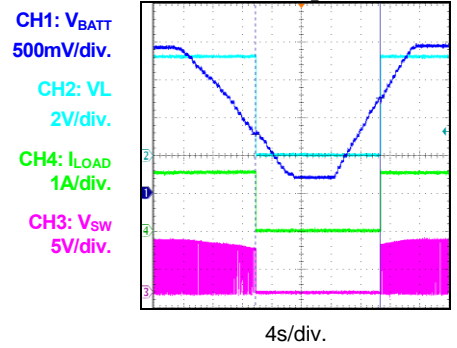

**Discharge Output  
Current Limit**

$V_{BATT} = 6.6V$ ,  $R_{OLIM} = 100k\Omega$

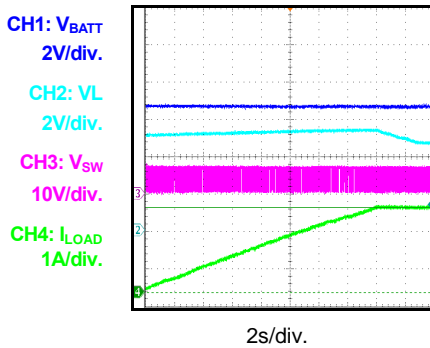

**Load Transient,  
Discharge Mode**

$V_{BATT} = 8.0V$ , load transient from 0.5A to 2.5A

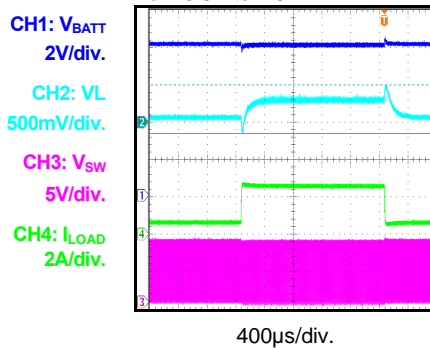

**Power Off by PB,  
Discharge Mode**

$V_{BATT} = 8.0V$ ,  $I_{LOAD} = 5A$

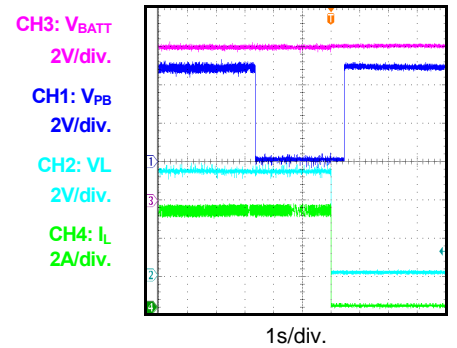

**Short Protection,  
Discharge Mode**

$V_{BATT} = 8.0V$ ,  $I_{LOAD} = 5A$ ,  $V_L$  short to GND

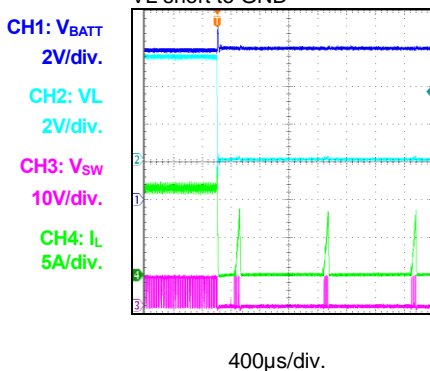

**Short Recovery,  
Discharge Mode**

$V_{BATT} = 8.0V$ ,  $I_{LOAD} = 5A$ ,  $V_L$  short to GND

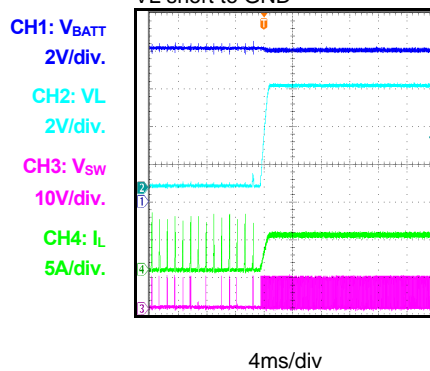

**LED Indication  
Discharge Mode**

$V_{BATT\_OFFSET} = 5V$

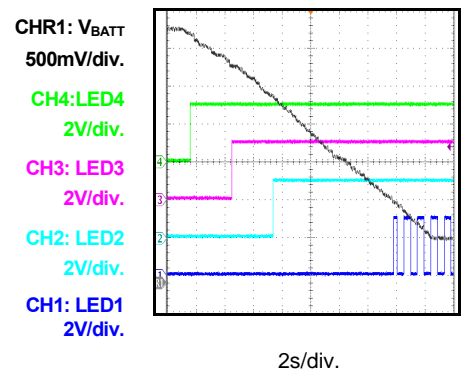

## PIN FUNCTIONS

| Pin # | Name | Type  | Description   |
|-------|------|-------|---|
| 1     | VL   | Power | <b>Low-voltage terminal.</b> Attach a 5V input to VL.   |
| 2     | LX   | Power | <b>Connection node between the induction and internal block switch.</b>   |
| 3     | VH   | Power | <b>High-voltage terminal.</b> Attach a 2-cell battery to VH.  |
| 4     | SW   | Power | <b>Switching node.</b>  |
| 5     | PGND | Power | <b>Power ground.</b> Connect the exposed pad and GND to the same ground plane.  |
| 6     | BST  | Power | <b>Bootstrap.</b> Connect a 100 - 500nF BST capacitor between the BST and SW node.  |
| 7     | PB   | I     | <b>Push button input.</b> Connect a push button from PB to AGND pulled up internally by a resistor. When PB is pushed for less than 2.5s, the discharge function is enabled and latched when MODE is high. If discharging is enabled, push PB for more than 2.5s to disable the discharge. Otherwise, discharging remains, and LED1-4 are enabled for 5s. |
| 8     | MODE | I     | <b>Charge or discharge mode selection.</b> Pull MODE to low logic to make the MP2639A work in charge mode. Pull MODE to logic high to make the MP2639A work in discharge mode.  |
| 9     | VCC  | I/O   | <b>Internal circuit power supply.</b> Bypass VCC to AGND with a 1 $\mu$ F ceramic capacitor. VCC cannot float or carry an external load higher than 50mA.   |
| 10    | AGND | I/O   | <b>Analog ground.</b>   |
| 11    | TMR  | I     | <b>Oscillator period timer.</b> Connect a timing capacitor between TMR and AGND to set the oscillator period. Short TMR to AGND to disable the timer function.  |
| 12    | MID  | I     | <b>Middle point of the 2-cell battery.</b> MID is used to detect the voltage of each cell in a 2-cell application. Connect MID to GND if it is not being used.  |
| 13    | LED1 | O     | <b>Fuel gauge indication.</b> LED1 works with LED2, LED3, and LED4 to achieve the voltage-based fuel gauge.   |
| 14    | LED2 | O     | <b>Fuel gauge indication.</b> LED2 works with LED1, LED3, and LED4 to achieve the voltage-based fuel gauge.   |
| 15    | LED3 | O     | <b>Fuel gauge indication.</b> LED3 works with LED1, LED2, and LED4 to achieve the voltage-based fuel gauge.   |
| 16    | LED4 | O     | <b>Fuel gauge indication.</b> LED4 works with LED1, LED2, and LED3 to achieve the voltage-based fuel gauge.   |
| 17    | FB   | I     | <b>Voltage feedback input in discharge mode.</b>  |
| 18    | VLIM | I     | <b>Input voltage limit setting in charge mode.</b>  |
| 19    | VNTC | O     | <b>Pull-up bias voltage of both the NTC resistive dividers.</b> VNTC is connected to VCC by an internal switch, which is turned on only in charge mode. Do not connect any capacitors to VNTC.  |
| 20    | NTC  | I     | <b>Negative temperature coefficient (NTC) thermistor.</b>   |

**PIN FUNCTIONS** *(continued)*

| Pin # | Name | Type | Description  |
|-------|------|------|--|
| 21    | IB   | O    | <b>Current output for the battery current monitor.</b> IB is proportional to the real battery current. Connect an R-C filter from IB to AGND.            |
| 22    | OLIM | I    | <b>Discharge output current limit setting.</b> Connect an external resistor from OLIM to AGND to program the system current.                             |
| 23    | ISET | I    | <b>Charge current set.</b> Connect an external resistor from ISET to AGND to program the charge current.   |
| 24    | ILIM | I    | <b>Input current limit setting in charge mode.</b>   |
| 25    | ACOK | O    | <b>Valid input supply indicator.</b> ACOK is an open-drain output. ACOK is pulled low when the input voltage is recognized as a good source.             |
| 26    | CHG  | O    | <b>Charging completion indicator.</b> CHG at logic low indicates charge mode. CHG becomes an open drain once the charging has completed or is suspended. |

**BLOCK DIAGRAM**

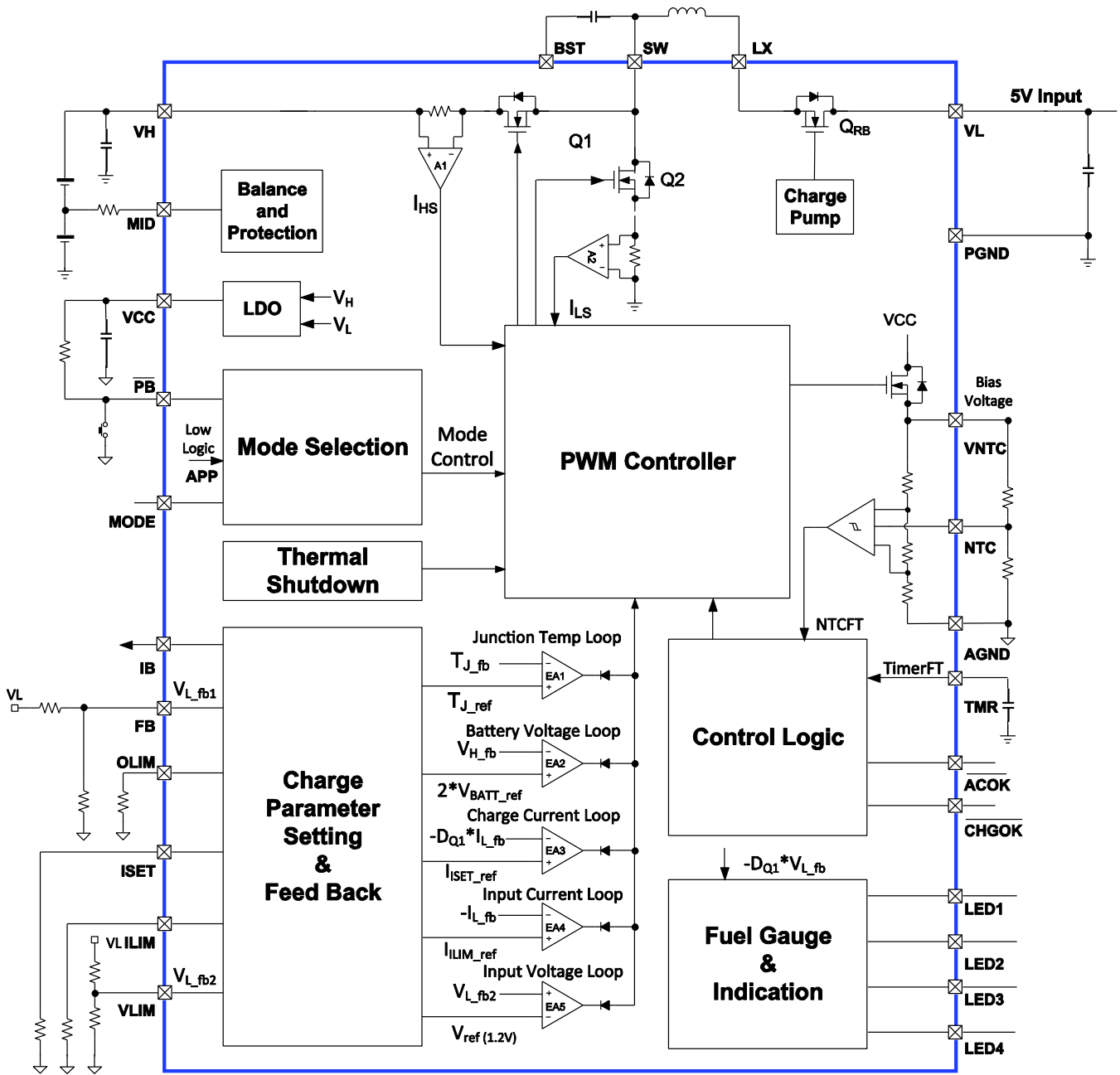

Figure 1: Block Diagram for 2-Cell Charge Mode



**BLOCK DIAGRAM** (continued)

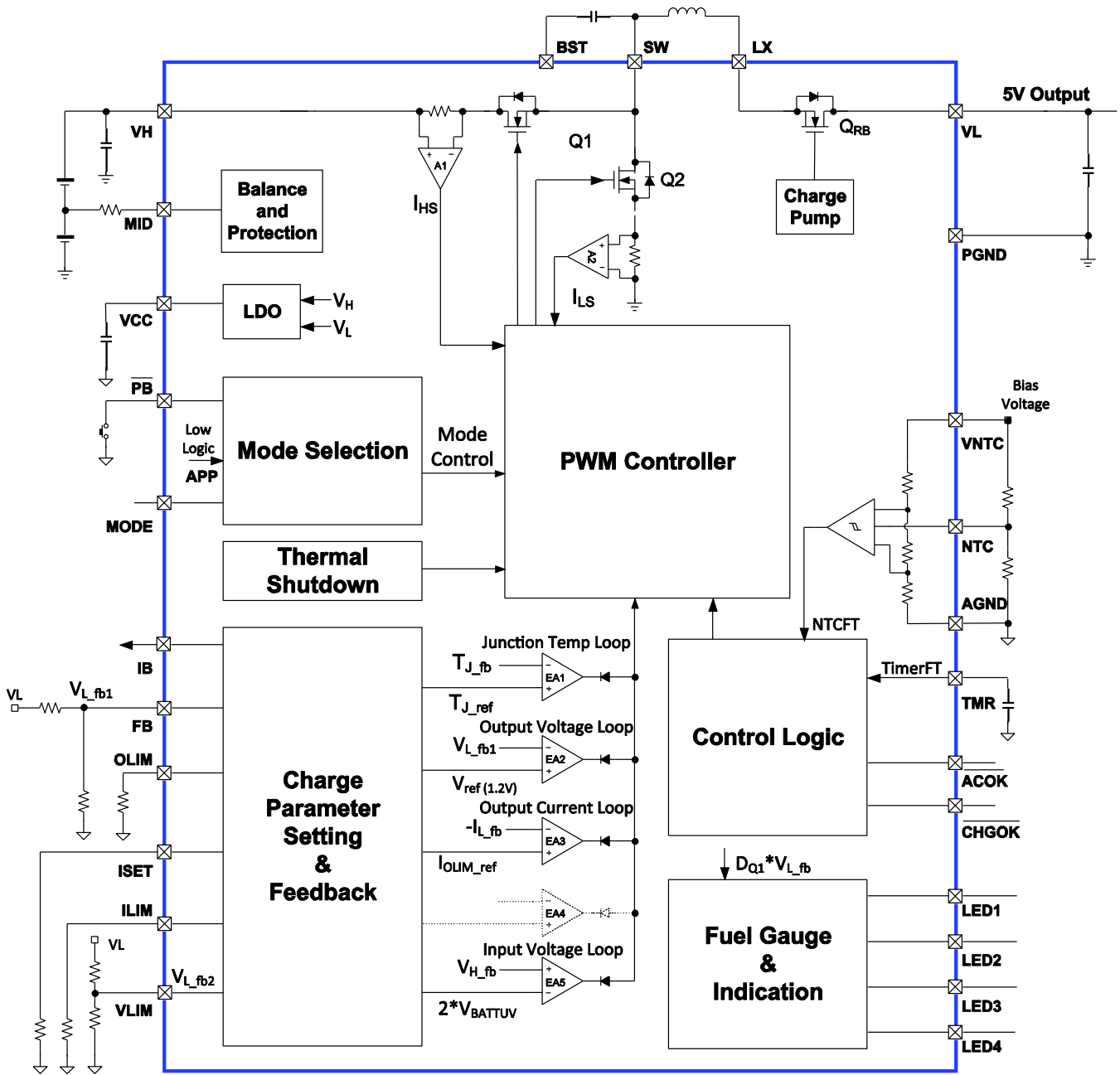

Figure 2: Block Diagram for 2-Cell Discharge Mode

**FLOW CHART**

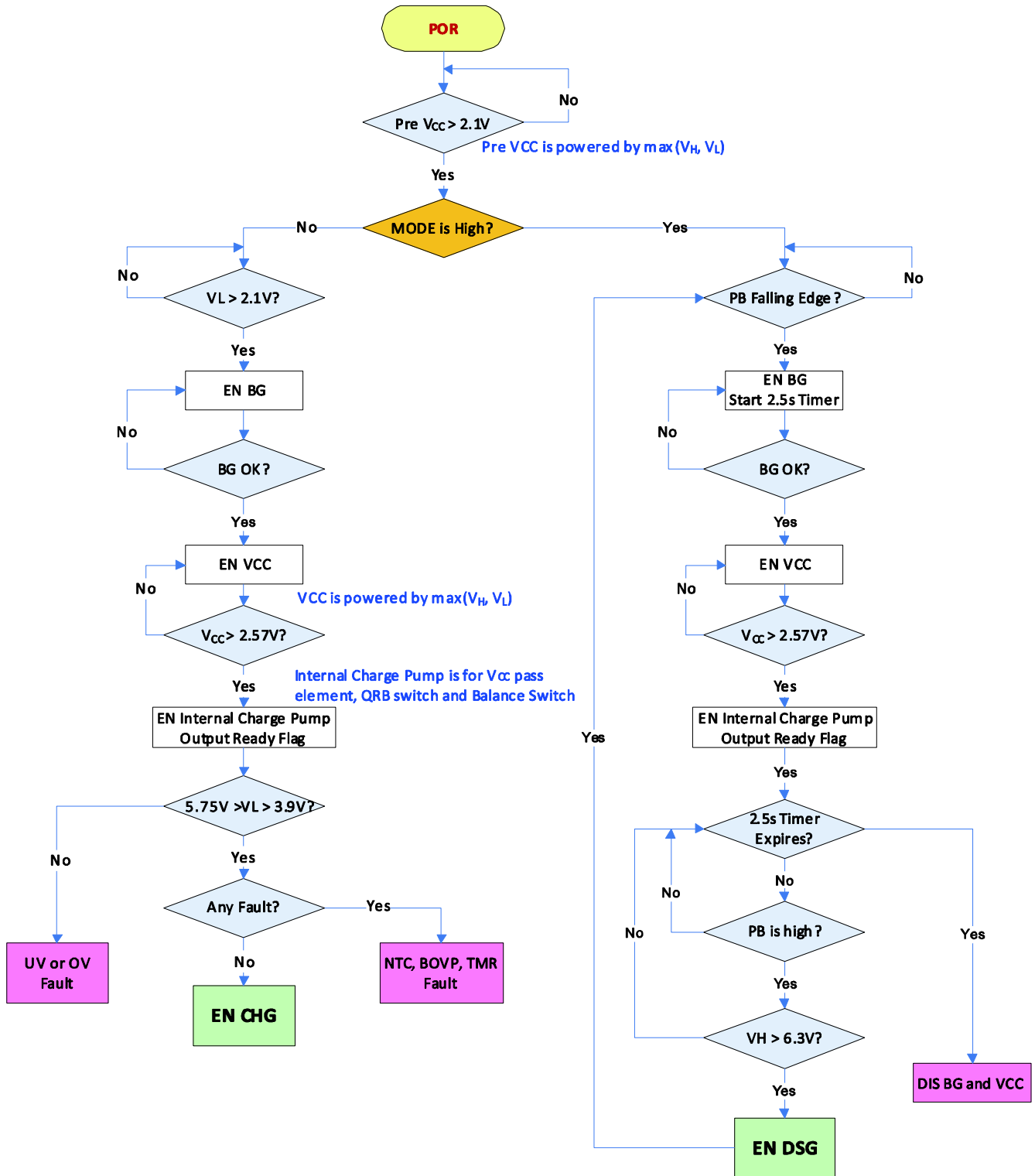
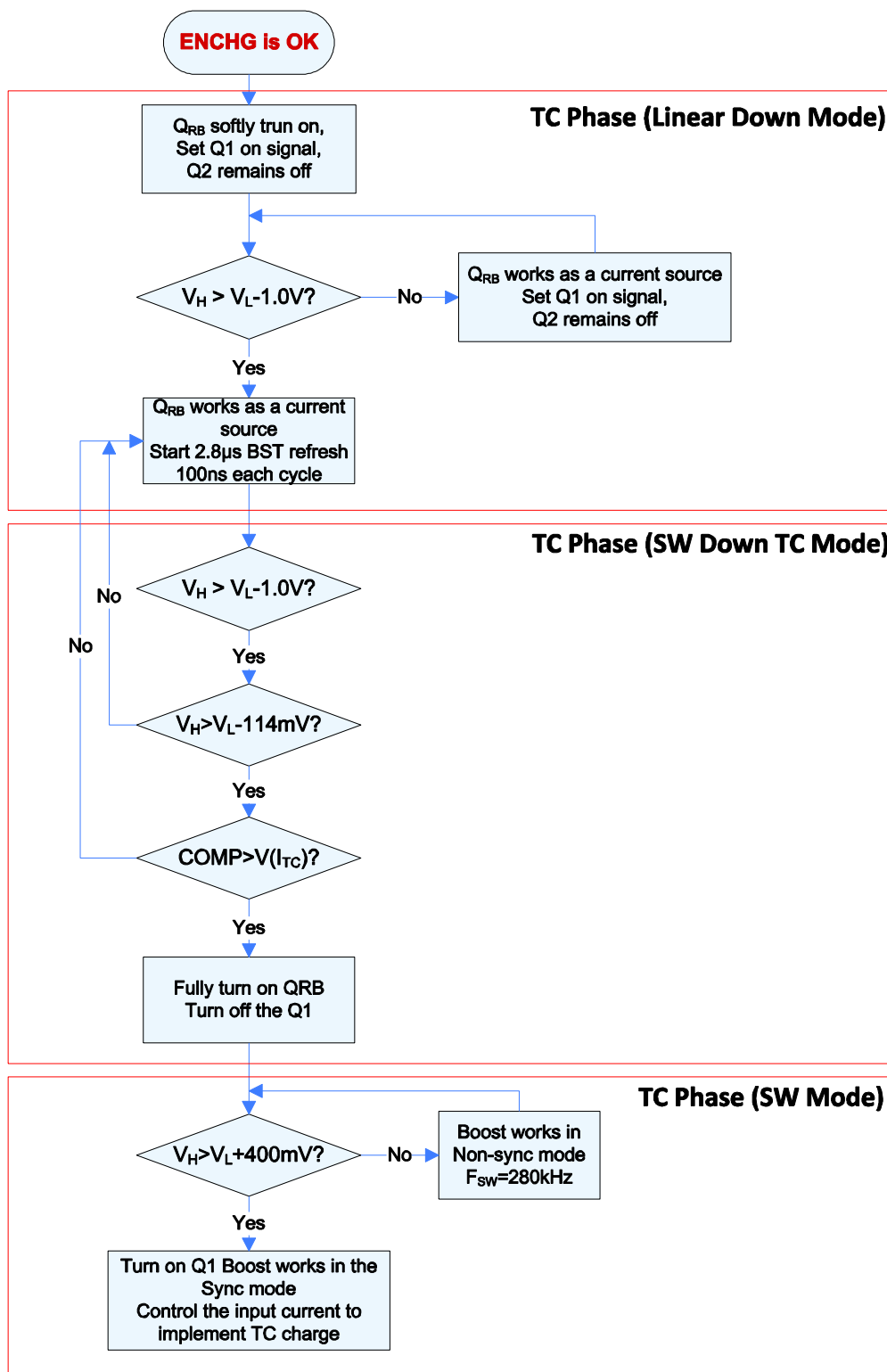

Figure 3: Input Power Start-Up Flow Chart

**FLOW CHART** (continued)



**Figure 4: Three-Phase Trickle Charge**

## OPERATION

The MP2639A is a highly integrated, switch-mode battery charger with a sophisticated control strategy to charge 2-cell series Lithium-ion or Lithium-polymer batteries from a 5V adapter or USB input.

### MODE Control

When MODE is low, the MP2639A works in charging mode to charge a 2-cell series battery from 5V. The MP2639A operates in step-up mode at this time, and Q2 works as the active switch, while Q1 works as the synchronous switch.

When MODE is high, the MP2639A is configured to discharge mode. Once discharge mode is enabled, the MP2639A operates in reverse to achieve a 5V output from a 2-cell battery via step-down mode (see Table 1).

**Table 1: Operation MODE Table**

| Adapter Term | BATT Term | MODE | CHG/DIS | Active SW | Topology  |
|--------------|-----------|------|---------|-----------|-----------|
| VL           | VH        | High | DSG     | Q1        | Step-down |
|              |           | Low  | CHG     | Q2        | Step-up   |

### Internal Power Supply

The VCC output is used to power the internal circuit and the MOSFET driver. This output is supplied by the higher terminal voltage value of VL or VH. After VL is set, the internal reference voltage is set up during charge mode. In discharge mode, VH is always higher than the output voltage, so VCC is always comes from VH when VH is higher than the under-voltage lockout (UVLO).

Connect an external capacitor from VCC to AGND. The VCC output current limit is 50mA. Figure 3 shows the MODE selection and power start-up flow chart in each mode.

### Battery Current Monitor

The MP2639A has an IB pin to represent the real battery current in both charge and discharge mode. The current flowing out from IB is proportional to the real battery current. An external, precise, sense resistor can convert the current signal to a voltage signal. Calculate the IB voltage with Equation (1):

$$V_{IB} = \frac{3 \cdot I_{BATT}}{400k} \cdot R_{IB} \quad (1)$$

The sense gain can be programmed by the external resistor ( $R_{IB}$ ) connected from IB to GND. For example, for a 40kΩ  $R_{IB}$ , a 0.3V  $I_B$  value represents a 1A battery current.

## CHARGE MODE

### Input Power Start-Up

As shown in Figure 3, once VCC exceeds the UVLO threshold, the MP2639A qualifies both the LV side and HV side voltage according to the MODE status.

In charging mode, VL is the input power terminal. Once  $V_{OVLO} > V_{LV} > V_{UVLO}$  and no fault occurs, the MP2639A is ready for charging.

As shown in Figure 4, depending on VH, the MP2639A operates in three different trickle-current charge modes: linear down mode, switch down mode, and switch TC mode (see Table 2).

1. *Linear Down Mode:* When  $V_H < V_L - 1V$ , the  $Q_{RB}$  MOSFET works linearly to charge the battery with the trickle charge current. At this time, the pulse-width modulation (PWM) block delivers the Q2 off signal and Q1 on signal. The BST refresh block is still disabled, so the Q1 MOSFET cannot be on. When  $V_H > V_L - 1V$ , a 2.8μs BST refresh window launches. In this window, the low-side Q2 MOSFET is turned on for 100ns each cycle (1.3MHz). Whenever Q1 is set to be on for 270μs, the 2.8μs BST refresh window is launched again.
2. *Switch Down Mode:* When  $V_H > V_L - 114mV$ ,  $Q_{RB}$  is fully on, Q1 is turned off, Q2 is switching, and  $F_{SW}$  is lowered to 280kHz.
3. *Switch TC Mode:* When  $V_H > V_L + 400mV$ ,  $Q_{RB}$  remains fully on, Q1 is turned off, Q2 is switching, and  $F_{SW}$  recovers to 1.3MHz.

**Table 2: Operation Mode**

|  |   |
|--|---|
| <b>V<sub>BATT</sub> Rising, Quit Linear Down Mode</b><br>(enter switch down mode)    | V <sub>H</sub> > V <sub>L</sub> - 114mV |
| <b>V<sub>BATT</sub> Falling, Enter Linear Down Mode</b><br>(quit switch down mode)   | V <sub>H</sub> < V <sub>L</sub> - 342mV |
| <b>V<sub>BATT</sub> Rising, Quit Switch Down Mode</b><br>(enter normal switch mode)  | V <sub>H</sub> > V <sub>L</sub> + 400mV |
| <b>V<sub>BATT</sub> Falling, Enter Switch Down Mode</b><br>(quit normal switch mode) | V <sub>H</sub> < V <sub>L</sub> + 114mV |

**Battery Charge Profile**

The MP2639A provides three main charging phases: trickle-current, constant-current charge, and constant-voltage charge (see Figure 5).

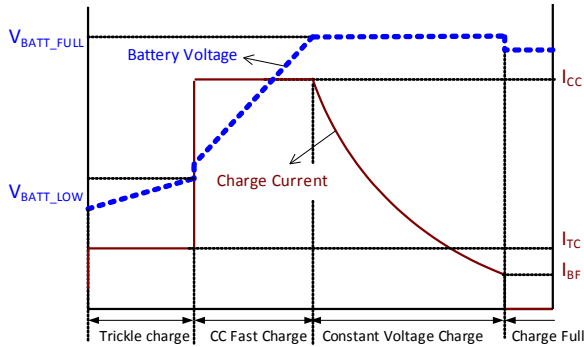

**Figure 5: Battery Charge Profile**

1. Phase 1 (trickle-current charge): When the battery voltage is lower than V<sub>BATT\_LOW</sub>, the MP2639A applies a safe trickle-charge current (I<sub>TC</sub>) to the deeply depleted battery until the battery voltage reaches trickle charge to the fast charge threshold (V<sub>BATT\_LOW</sub>). If V<sub>BATT\_LOW</sub> is not reached before the trickle-charge timer expires, the charge cycle is ceased, and a corresponding timeout fault signal is asserted. See the Safety Timer section on page 21 for more detail.
2. Phase 2 (constant-current charge): When the battery voltage exceeds V<sub>BATT\_LOW</sub>, the MP2639A stops the trickle-current charge phase and enters constant-current charge (fast charge) phase with a soft start. The fast charge current can be programmed via ISET.

3. Phase 3 (constant-voltage charge): When the battery voltage rises to the charge-full voltage (V<sub>BATT\_FULL</sub>), the charge current begins to taper off. The charge cycle is considered complete when the CV loop is dominated, and the charge current reaches the battery-full termination threshold. A 500μs force charge time is designed for each charge cycle. After the 500μs force charge time expires, the charge full signal is allowed to assert.

If I<sub>BF</sub> is not reached before the safety charge timer expires, the charge cycle is ceased, and the corresponding timeout fault signal is asserted. See the Safety Timer section for more detail.

A new charge cycle starts when the following conditions are valid:

- The input power is re-plugged.
- MODE is toggled from high to low.
- No thermistor fault at NTC.
- No safety timer fault.
- No battery over-voltage.

**Automatic Recharge**

When the battery is fully charged and the charging is terminated, the battery may be discharged for system consumption or self-discharge. The MP2639A starts a new charging cycle automatically without requiring a manual restart of a charging cycle.

**Charge Current Setting**

ISET is used to program the charge current. The setting formula is shown in Equation (2):

$$I_{CHG} = \frac{640(k\Omega)}{3 \times R_{ISET}} (A) \tag{2}$$

**Battery Over-Voltage Protection (OVP)**

The MP2639A is designed with a built-in battery over-voltage limit of 103.3% of V<sub>BATT\_FULL</sub>. When a battery over-voltage event occurs, the MP2639A suspends the charging immediately.

**Non-Sync Mode**

When the input current at the VL side is lower than 330mA, the MP2639A turns off Q1 and switches to non-sync operation.

**Safety Timer**

The MP2639A uses an internal timer to terminate the charging. The timer remains active during the charging process. An external capacitor between TMR and AGND programs the charge cycle duration. An internal current source charges and discharges the external capacitor alternatively. When the voltage across C<sub>TMR</sub> is lower than 0.7V, the internal current source charges C<sub>TMR</sub>. Once the voltage exceeds 1.5V, the internal current source begins to discharge C<sub>TMR</sub>. As a result, the voltage across C<sub>TMR</sub> oscillates between 0.7V and 1.5V periodically, like a triangle wave. There are two counter limits for the trickle charge and total charge processes: 45056 for trickle charge and 3407872 for CC and CV charge. Once the counter reaches the corresponding limit, the timer expires, and the charging is suspended (see Figure 6).

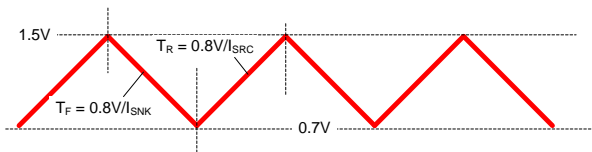

**Figure 6: Voltage Profile of TMR**

In trickle-charge mode, the input trickle-charge current is fixed at 300mA. The trickle-charge time ( $\tau_{TC\_TMR}$ ) is set using Equation (3):

$$\tau_{TRICKLE\_TMR} = 33.7\text{mins} \times \frac{C_{TMR}(\mu\text{F})}{0.1\mu\text{F}} \quad (3)$$

In CC and CV mode, the internal I<sub>OSC</sub> is proportional to the reference of the inductor current and is independent of the input current. The total charge time ( $\tau_{TOTAL\_TMR}$ ) is set using Equation (4):

$$\tau_{TOTAL\_TMR} = 6.05\text{Hours} \times \frac{C_{TMR}(\mu\text{F})}{0.1\mu\text{F}} \times \frac{1\text{A}}{I_L(\text{A}) + 0.08} \quad (4)$$

In the event of an NTC hot and cold fault, the charging timer should be suspended. Once the NTC fault is removed, the timer continues counting from the value before an NTC fault.

**Negative Temperature Coefficient (NTC) Thermistor**

“Thermistor” is the generic name given to thermally sensitive resistors. A negative temperature coefficient thermistor is called a thermistor, typically. Depending on the manufacturing method and the structure, there are many shapes and characteristics available for various purposes. The thermistor resistance values, unless otherwise specified, are classified at a standard temperature of 25°C. The resistance of a temperature is solely a function of its absolute temperature.

The relationship between the resistance and the absolute temperature of a thermistor is shown in Equation (5):

$$R_1 = R_2 \cdot e^{\beta \left( \frac{1}{T_1} - \frac{1}{T_2} \right)} \quad (5)$$

Where R1 is the resistance at absolute temperature T1, R2 is the resistance at absolute temperature T2, and  $\beta$  is a constant that depends on the material of the thermistor.

The MP2639A monitors the battery’s temperature continuously by measuring the voltage at NTC during charge mode. This voltage is determined by the resistor divider, whose ratio is produced by different resistances of the NTC thermistor under different ambient temperatures of the battery.

The MP2639A sets a pre-determined upper and lower bound of the range internally. If the voltage at NTC goes out of this range, then the temperature is outside of the safe operating limit. At this time, charging stops unless the operating temperature returns to the safe range.

To satisfy the JEITA requirement, the MP2639A monitors four temperature thresholds: the cold battery threshold ( $T_{NTC} < 0^\circ\text{C}$ ), the cool battery threshold ( $0^\circ\text{C} < T_{NTC} < 10^\circ\text{C}$ ), the warm battery threshold ( $45^\circ\text{C} < T_{NTC} < 60^\circ\text{C}$ ), and the hot battery threshold ( $T_{NTC} > 60^\circ\text{C}$ ). For a given NTC thermistor, these temperatures correspond to V<sub>COLD</sub>, V<sub>COOL</sub>, V<sub>WARM</sub>, and V<sub>HOT</sub>. When  $V_{NTC} < V_{HOT}$  or  $V_{NTC} > V_{COLD}$ , charging and the timers are suspended. When  $V_{HOT} < V_{NTC} < V_{WARM}$ , the charge-full voltage (V<sub>BATT\_FULL</sub>) is reduced by 140mV from the programmable threshold.

When  $V_{COOL} < V_{NTC} < V_{COLD}$ , the charging current is reduced to half of the programmed charge current (see Figure 7).

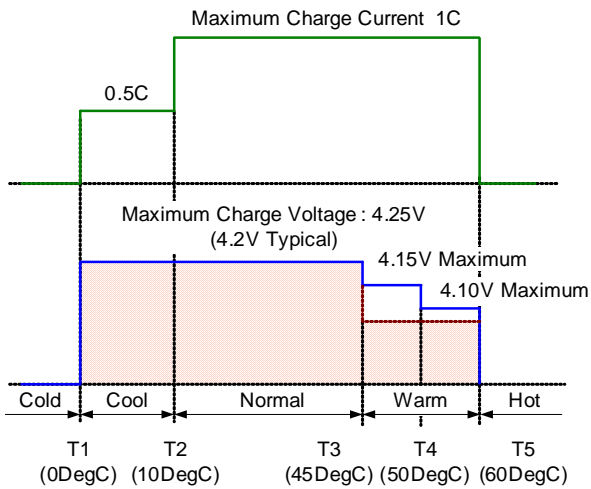

**Figure 7: JEITA-Compatible NTC Window**

**VNTC Output**

VNTC is an input pin used to pull up both the internal and external resistor dividers to the same point (see Figure 8). VNTC is connected to VCC via an internal switch. In charging mode, the switch is turned on, and VNTC is connected to VCC. In discharge mode, the switch is off, and VNTC is bridged off from VCC.

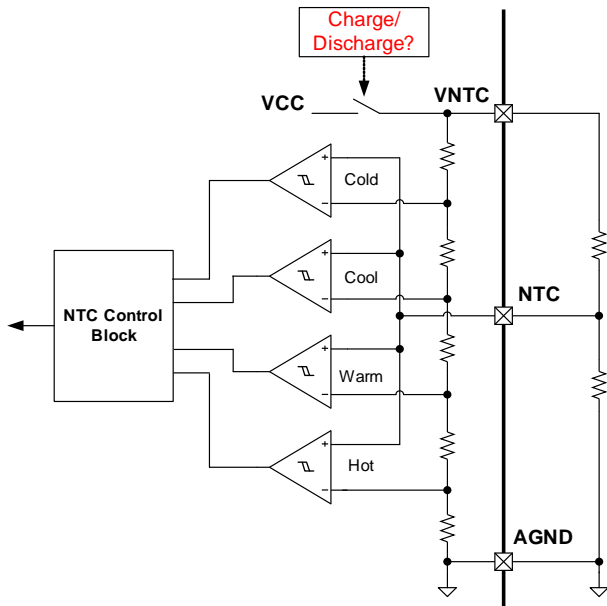

**Figure 8: NTC Protection Circuit**

**Input Voltage-Based and Input Current-Based Power Management**

To meet the USB maximum current limit specification and avoid overloading the adapter, the MP2639A features both input current- and input voltage-based power management by monitoring the input current and input voltage continuously. The total input current limit can be programmed to prevent the input source from overloading. When the input current reaches its limit, the charge current tapers off to keep the input current from increasing further. The input current limit can be calculated with Equation (6):

$$I_{LIM} = \frac{640(k\Omega)}{3 \times R_{LIM}} (A) \tag{6}$$

If the preset input current limit is higher than the rating at the adapter, the back-up input voltage-based power management also works to prevent the input source from being overloaded. When the input voltage falls below the input voltage limit due to an overload, the charge current is reduced to keep the input voltage from dropping further.

The input voltage clamp threshold can be programmed by VLIM. The internal reference of the input voltage loop is 1.2V, so the input voltage clamp limit can be calculated with Equation (7):

$$V_{IN\_REG} = 1.2V \times \frac{R3 + R4}{R4} \tag{7}$$

**Indication**

The MP2639A integrates indicators for the conditions shown in Table 3.

**Table 3: Indication in Difference Cases**

| Charging State |  | ACOK | CHGOK                 |
|----------------|--|------|-----------------------|
| Mode is low    | In Charging  | Low  | Low                   |
|                | Charging complete, sleep mode, charge disable, battery OVP | Low  | High                  |
|                | NTC fault, timer fault,                                    | Low  | Blinking at fixed 1Hz |
| Mode is high   | Discharging  | High | High                  |



**DISCHARGE MODE**

**Discharge Control**

When MODE is configured high, discharge mode is enabled. However, discharging can only be enabled or disabled when the push button pin (PB) is configured properly.

A short push is defined as PB being pulled low for less than 2.5s. A long push is defined as PB being pulled low for longer than 2.5s.

In the MP2639A, discharging is enabled only when MODE is high and a short push is detected. Discharging is disabled once MODE is pulled low or a long push is detected.

Figure 9 shows the steps below.

1) Before t0, MODE is high, and discharging has already been enabled. PBDIS is the enable signal of the discharging. If PBDIS is high, discharging is enabled. If PBDIS is low, discharging is disabled.

- 2) During t0, PB is pulled low, and the 2.5s timer is reset. PB is released to high before the 2.5s timer expires, so a short push is detected. PBDIS remains high, and discharging continues.
- 3) During t1, PB is pulled low again, and the 2.5s timer is reset. PB remains low until the 2.5s timer expires, so a long push is detected. PBDIS is pulled low, and discharging ceases. Then PBDIS rises high once PB goes high.
- 4) At the moment of t2, another long push is detected. Discharging is still disabled.
- 5) At the moment of t3, a short push is detected, and PBDIS remains high. Discharging is enabled.

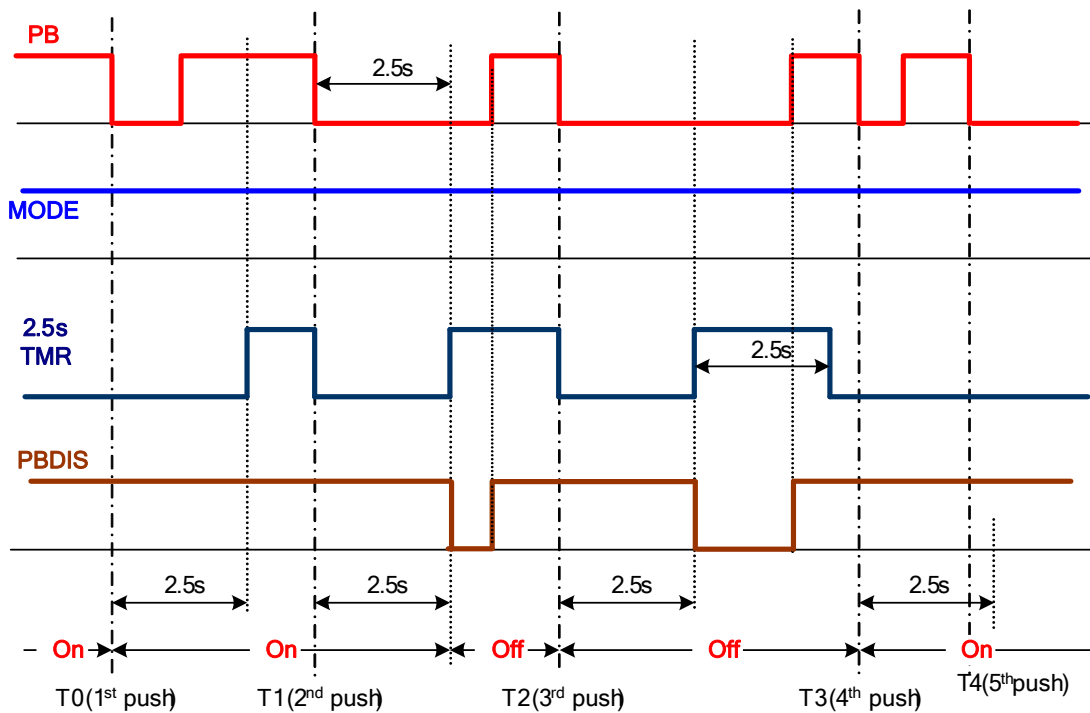

**Figure 9: Push Button Detection Profile**



Since the MP2639A is in sleep mode, if  $\overline{PB}$  is pulled down to AGND for less than 2.5s (short push), the IC enters discharge mode, and the LEDs display the battery capacity. After 5s, the LED pins switch to open drain automatically to minimize the battery quiescent current. For the LED to display the battery capacity, short push  $\overline{PB}$ .

**No-Load Automatic Shutdown**

In discharge mode, the MP2639A monitors the discharge current continuously. When the discharge current ( $I_{BATT}$ ) is lower than 50mA, discharging can be shut down after 20s automatically (see Figure 10).

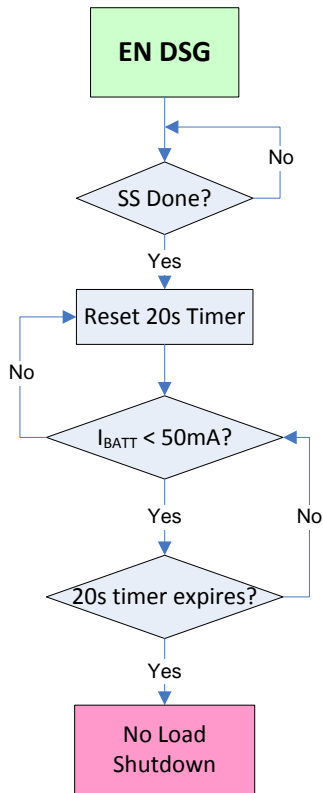

**Figure 10: No-Load Shutdown Detection**

**Output Over-Voltage Protection (OVP)**

The MP2639A has an internal, output, over-voltage protection (OVP). If the voltage at the VL node is higher than 5.75V, and an external, abnormal voltage is added or FB is pulled to GND falsely, then the MP2639A disables the discharge and turns off the  $Q_{RB}$  MOSFET. When the output voltage returns to a safe level, the MP2639A restarts the discharging.

**Output Over-Current Limit (OCL)**

The MP2639A features an output over-current limit (OCL), which can be programmed by the resistor connected from OLIM to AGND. When the output current flowing out from the VL node exceeds the output over-current limit, the MP2639A regulates the duty cycle to maintain the output current at this limit, so the output voltage drops accordingly. The output current limit can be set using Equation (8):

$$I_{OLIM} = \frac{640(k\Omega)}{3 \times R_{OLIM}} (A) \tag{8}$$

**Output Short-Circuit Protection (SCP)**

The MP2639A monitors the VL voltage continuously. If VL drops below 3.9V, an event of the output short circuit is detected. The MP2639A works in hiccup mode with 1.2ms intervals, and the peak current limit of the high-side switch is cut by half (see Figure 11).

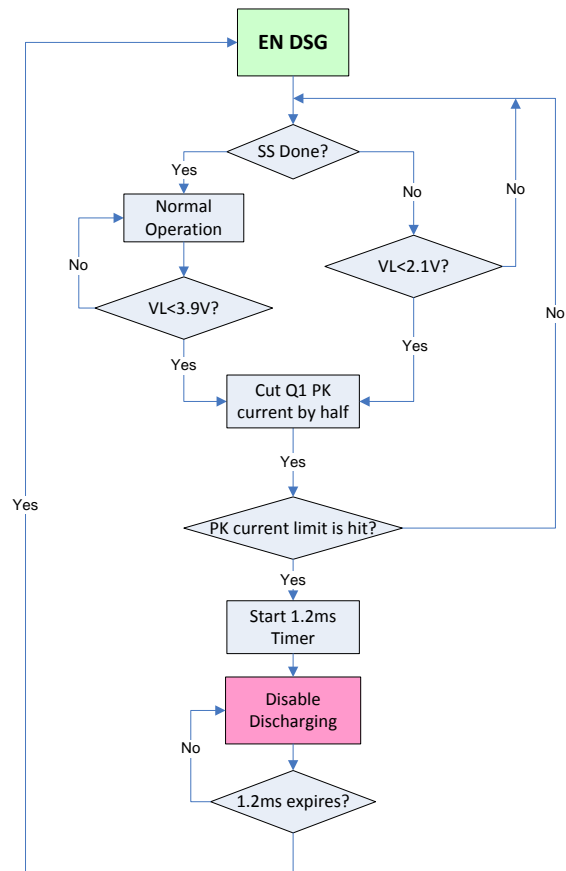

**Figure 11: Output Short-Circuit Protection**

**Over-Discharge Control**

The MP2639A has a battery over-discharge control scheme to avoid over-discharging. During discharging, the MP2639A shuts down automatically when the battery voltage declines to 5.75V, and the MP2639A recovers to discharge when the battery voltage is over 6.28V.

**Battery Cell Balance and Protection**

The MP2639A provides battery cell balance and protection for 2-cell applications. The MP2639A senses the voltage across each cell. If the two cell voltages are too different, the balance function begins, and the internal discharge circuit is turned on to decrease the charge current of the cell with the higher voltage. If the voltage across one of the cells exceeds the battery OVP threshold, the charging stops. If the two cell voltages are still too different, the cell with the higher voltage discharges to balance until the two cell voltages match or the part recovers from OVP (120mV lower than the OVP threshold) and recharges.

The MP2639A integrates the balance MOSFET and control circuit (see Figure 12).

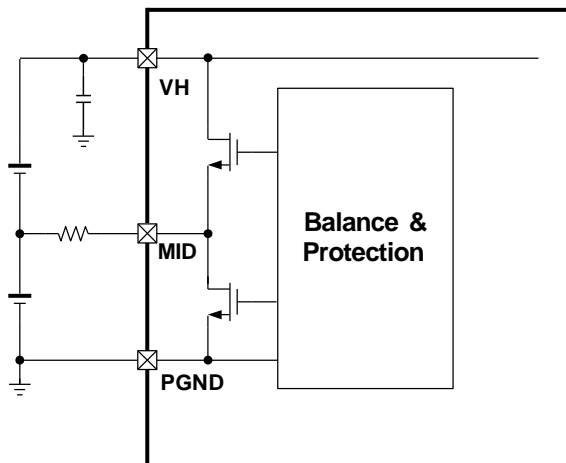

**Figure 12: Block Diagram of the Battery Balance**

The balance current (less than 200mA) depends on the external resistor from MID to the middle of the 2-cell battery. If a larger balance current is needed, then refer to the external balance circuit in Figure 18.

The balancing algorithm will enable automatically when the following conditions are true:

1. The balance block is only active when a valid power source is present and charging is enabled.<sup>(6)</sup>
2. At least one of the cell voltages is higher than the balance starting voltage (typical 3.5V).
3. The voltage difference between the cells is higher than the balance threshold (65mV).

**NOTE:**

6) The balance block is valid only while the charge function is applied. If both the charge and discharge functions are enabled, disable the balance block by connecting MID to GND.

The MP2639A detects the cell with the lower voltage ( $V_{C_{MIN}}$ ) and checks the voltage difference between each cell. If the differential voltage is higher than the balance threshold (65mV), the related balance MOSFET is turned on, and the charge current of the cell with the higher voltage is decreased.

The balancing action is suppressed if the higher cell voltage is less than the cell-balance start voltage ( $V_{CBST}$ ) or the cell-voltage measurement is active.

In each balance cycle, the cell voltage measures for about 200µs and balances for about 200ms. Cell measurements are frozen when the balance is ongoing.

The cell balance flow chart is shown in Figure 13.

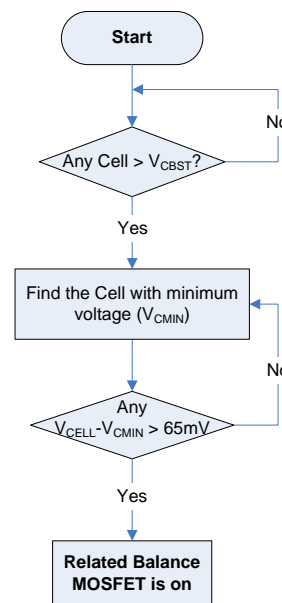
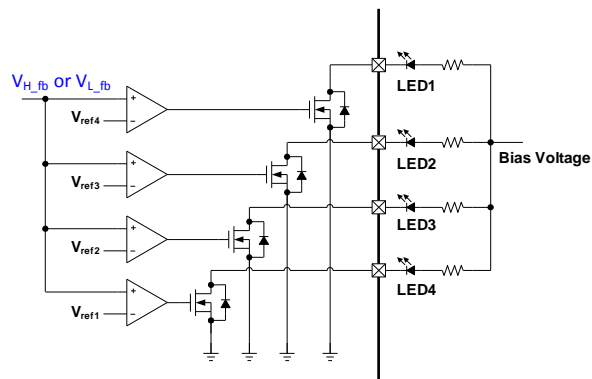

**Figure 13: Flow Chart of the Battery Balance**

### Voltage-Based Fuel Gauge

The MP2639A integrates four comparators and an open-drain circuit to indicate the fuel gauge via four LEDs during both charge and discharge mode (see Figure 14). The MP2639A compares the battery voltage with four voltage references to reveal the capacity of the battery, with four options of 25%, 50%, 75%, and 100%.

The indication plan is shown in Table 4.



**Figure 14: Block Diagram of Fuel Gauge**

**Table 4: Voltage-Based Fuel Gauge Indication**

| 2-Cell Charge            | LED1            | LED2            | LED3            | LED4            | CHG |
|--------------------------|-----------------|-----------------|-----------------|-----------------|-----|
| Done                     | On              | On              | On              | On              | Off |
| 8.4V                     | On              | On              | On              | On              | On  |
| $8.2V < V_{BATT} < 8.4V$ | On              | On              | On              | Blinking at 1Hz | On  |
| $7.8V < V_{BATT} < 8.2V$ | On              | On              | Blinking at 1Hz | Off             | On  |
| $7.4V < V_{BATT} < 7.8V$ | On              | Blinking at 1Hz | Off             | Off             | On  |
| $V_{BATT} < 7.4V$        | Blinking at 1Hz | Off             | Off             | Off             | On  |

| 2-Cell Discharge         | LED1            | LED2 | LED3 | LED4 | CHG |
|--------------------------|-----------------|------|------|------|-----|
| $8V < V_{BATT}$          | On              | On   | On   | On   | Off |
| $7.6V < V_{BATT} < 8V$   | On              | On   | On   | Off  | Off |
| $7.2V < V_{BATT} < 7.6V$ | On              | On   | Off  | Off  | Off |
| $6V < V_{BATT} < 7.2V$   | On              | Off  | Off  | Off  | Off |
| $V_{BATT} < 6V$          | Blinking at 1Hz | Off  | Off  | Off  | Off |

During discharge mode, to minimize the power consumption of the gauge indication, the indication control is designed in the MP2639A achieved by PB. When PB is short pushed, the gauge indication is enabled and disabled after 5s automatically.

**Discharge Line Drop Compensation**

The MP2639A integrates a discharge line compensation function to compensate for the voltage drop across the USB cable automatically.

The output voltage is compensated by feeding the output current to the top feedback resistance (R1) (see Figure 15).

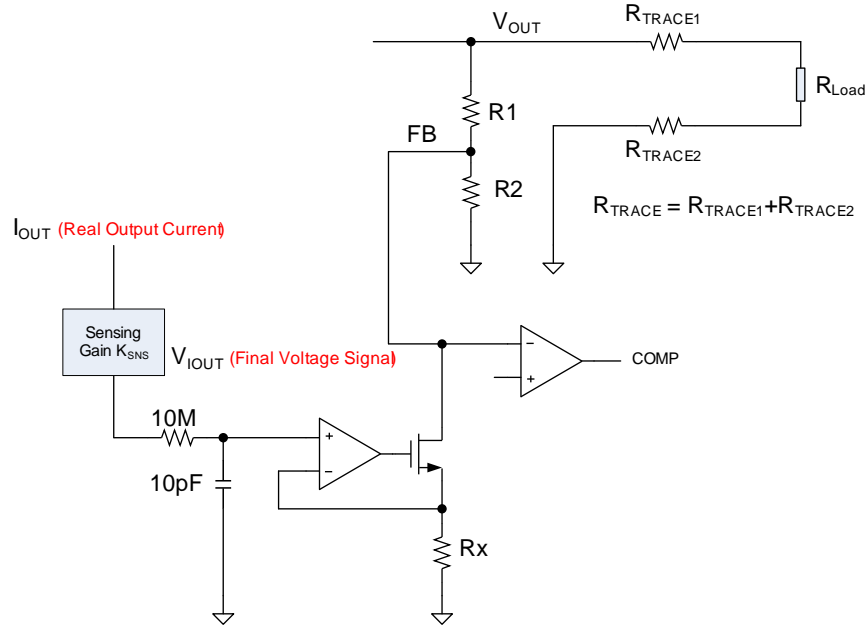

**Figure 15: Block Diagram of Line Drop Compensation**

If the trace to the load is long, there is a voltage drop between  $V_{OUT}$  and  $V_{LOAD}$ . The voltage at the output terminator ( $V_{OUT}$ ) is not equal to the voltage at the load ( $V_{LOAD}$ ). The voltage drop is described in Equation (9):

$$V_{LOAD} = V_{OUT} - I_{OUT} \times R_{TRACE} \quad (9)$$

Where  $R_{TRACE}$  is the resistance of the cable.

To maintain an accurate and constant load voltage, output line drop compensation is necessary. The MP2639A offers a compensation method by adjusting the FB voltage ( $V_{FB}$ ) slightly according to the load current. The relation between  $V_{OUT}$  and  $V_{FB}$  is described in Equation (10):

$$\frac{V_{OUT} - V_{FB}}{R1} = \frac{V_{FB}}{R2} + \frac{V_{IOUT}}{Rx} \quad (10)$$

Where  $V_{IOUT}$  is the voltage signal representing the real output current.

The output voltage after compensation is shown in Equation (11):

$$V_{OUT} = \frac{R1+R2}{R2} \times V_{FB} + \frac{I_{OUT} \times K_{SNS}}{Rx} \times R1 \quad (11)$$

Ensure that  $V_{LOAD}$  is always equal to the output setting voltage with Equation (12):

$$V_{LOAD} = \frac{R1+R2}{R2} \times V_{FB} \quad (12)$$

To solve Equation (11) and Equation (12), use the value calculated from Equation (13):

$$\frac{I_{OUT} \times K_{SNS}}{Rx} \times R1 = I_{OUT} \times R_{TRACE} \quad (13)$$

Given a tested  $R_{TRACE}$ , R1 should be selected according Equation (14):

$$R1 = \frac{R_{TRACE} \times Rx}{K_{SNS}} \quad (14)$$

Where  $R_X$  is 150kΩ, and  $K_{SNS}$  is 0.3. In practice,  $R_{TRACE}$  ranges from 120 - 200mΩ.

Calculate R2 with Equation (15):

$$R2 = \left( \frac{V_{FB}}{V_{LOAD} - V_{FB}} \right) \times R1 \quad (15)$$

Where  $V_{LOAD}$  is equal to the regulation voltage, and  $V_{FB}$  is 1.2V.

For example, given an  $R_{TRACE}$  of 200m $\Omega$ , calculate R1 with Equation (16):

$$R1 = \frac{R_{TRACE} \times Rx}{K_{SNS}} = \frac{0.2 \times 150k}{0.3} = 100k \quad (16)$$

Where R2 is 31.6k $\Omega$  for a 5V regulation.

Given an  $R_{TRACE}$  of 120m $\Omega$ , calculate R1 with Equation (17):

$$R1 = \frac{R_{TRACE} \times Rx}{K_{SNS}} = \frac{0.12 \times 150k}{0.3} = 60k \quad (17)$$

Where R2 is 18.9k $\Omega$  for a 5V regulation.

Additionally, no matter how much the drop compensation is, the maximum compensation limit is 300mV. Given a 5V output application, the maximum regulation voltage at VL is 5.3V.

## APPLICATION INFORMATION

### Setting the Input Current Limit in Charge Mode

The input current limit setting is set according to the input power source capability. The input current limit can be set through ILIM. Connect a resistor from ILIM to AGND to program the input current limit. The relationship is calculated using Equation (18):

$$I_{ILIM} = \frac{640(k\Omega)}{3 \times R_{ILIM}} (A) \quad (18)$$

To set the input current limit to 3A, choose  $R_{ILIM}$  to be 71.5kΩ. To set the input current limit to 500mA according to the USB input request, choose  $R_{ILIM}$  to be 432kΩ. If  $R_{ILIM}$  is 0Ω, then there is no limit on the input current.

### Setting the Charge Current

The charge current of the MP2639A can be set by an external resistor ( $R_{ISET}$ ) according to Equation (19):

$$I_{CHG} = \frac{640(k\Omega)}{3 \times R_{ISET}} (A) \quad (19)$$

The charge current can be programmed to 2.5A. The expected  $R_{ISET}$  for a typical charge current is shown in Table 4.

**Table 4: Charge Current Setting Table**

| $R_{ISET}$ (kΩ) | Charge Current (A) |
|-----------------|--------------------|
| 215             | 1.0                |
| 143             | 1.5                |
| 107             | 2.0                |
| 84.5            | 2.5                |

### Setting the Input Voltage Regulation in Charge Mode

In charge mode, connect a resistor divider from VL to AGND tapped to VLIM to program the input voltage regulation using Equation (20):

$$V_{INLMT} = 1.2V \times \frac{R3 + R4}{R4} (V) \quad (20)$$

With the given R4, R3 can be calculated with Equation (21):

$$R3 = \frac{V_{INLMT} - 1.2V}{1.2V} \times R4 (V) \quad (21)$$

$V_{VLIM}$  is 1.2V. For a preset input voltage regulation value (i.e.: 4.675V), start with  $R4 = 10k\Omega$  and  $R3 = 27.4k\Omega$ .

### Setting the Output Current Limit in Discharge Mode

In discharge mode, connect a resistor from OLIM to AGND to program the output current limit. The relationship between the output current limit and setting resistor is shown in Equation (22):

$$I_{OLIM} = \frac{640(k\Omega)}{3 \times R_{OLIM}} (A) \quad (22)$$

The output current limit of the boost can be programmed up to 5.0A.

The expected  $R_{OLIM}$  for typical output current limits is shown in Table 5.

**Table 5: Discharge Current Setting Table**

| $R_{OLIM}$ (kΩ) | Charge Current (A) |
|-----------------|--------------------|
| 215             | 1.0                |
| 143             | 1.5                |
| 107             | 2.0                |
| 84.5            | 2.5                |

### Setting the Output Voltage in Discharge Mode

The MP2639A can regulate the output voltage on VL during discharge mode by adding voltage compensation to  $V_{LOAD}$ , which is the voltage powering the load. The setting formula for  $V_{LOAD}$  is shown in Equation (23):

$$V_{LOAD} = 1.2V \times \frac{R1 + R2}{R2} (V) \quad (23)$$

The IC implements internal line drop compensation by feeding the output current to the top feedback resistance (R1). The selection of R1 must satisfy Equation (24):

$$R1 = \frac{R_{TRACE} \times R_x}{K_{SNS}} \quad (24)$$

Where  $R_x$  is 150kΩ,  $K_{SNS}$  is 0, and  $R_{TRACE}$  is the line resistance of the trace from the output of the IC to the load of the system.

According to different evaluations on  $R_{TRACE}$ , choose an  $R_1$  value for correct compensation using Table 6. Suppose  $V_{LOAD}$  is required to regulate at 5V.

**Table 6: R1, R2 Selection Table**

| $R_{TRACE}$ | $R_1$ ( $\Omega$ ) | $R_2$ ( $\Omega$ ) |
|-------------|--------------------|--------------------|
| 20m         | 10k                | 3.16k              |
| 50m         | 15k                | 4.75k              |
| 100m        | 50k                | 15.8k              |
| 150m        | 75k                | 23.7k              |
| 200m        | 100k               | 31.6k              |

Note that there is a max compensation voltage limit on  $R_{TRACE}$ , which means that the compensated output voltage of the IC is a maximum of 0.3V higher than the voltage on the load side.

**Resistor Selection for the NTC Sensor**

Figure 16 shows an internal resistor divider reference circuit that limits both the high and low temperature thresholds at  $V_{TH\_High}$  and  $V_{TH\_Low}$ , respectively. For a given NTC thermistor, select an appropriate  $R_{T1}$  and  $R_{T2}$  value to set the NTC window using Equation (25) and Equation (26):

$$\frac{R_{T2} // R_{NTC\_Cold}}{R_{T1} + R_{T2} // R_{NTC\_Cold}} = \frac{V_{TH\_Low}}{V_{NTC}} \quad (25)$$

$$\frac{R_{T2} // R_{NTC\_Hot}}{R_{T1} + R_{T2} // R_{NTC\_Hot}} = \frac{V_{TH\_High}}{V_{CC}} \quad (26)$$

Where  $R_{NTC\_Hot}$  is the value of the NTC resistor at a high temperature (within the required temperature operating range), and  $R_{NTC\_Cold}$  is the value of the NTC resistor at a low temperature.

The two resistors ( $R_{T1}$  and  $R_{T2}$ ) allow the high and low temperature limits to be programmed independently. With this feature, the MP2639A can fit most types of NTC resistors and different temperature operating range requirements.

The  $R_{T1}$  and  $R_{T2}$  values depend on the type of NTC resistor selected.

For example, for a 103AT thermistor,  $R_{NTC\_Cold}$  is 27.28k $\Omega$  at 0°C, and  $R_{NTC\_Hot}$  is 3.02k $\Omega$  at 50°C.

The following equation calculations are derived assuming that the NTC window is between 0°C and 50°C. According to Equation (25) and

Equation (26), use  $\frac{V_{TH\_Low}}{V_{NTC}}$  and  $\frac{V_{TH\_High}}{V_{NTC}}$  from the

EC table to calculate  $R_{T1} = 2.27k\Omega$  and  $R_{T2} = 6.86k\Omega$  (see Figure 16).

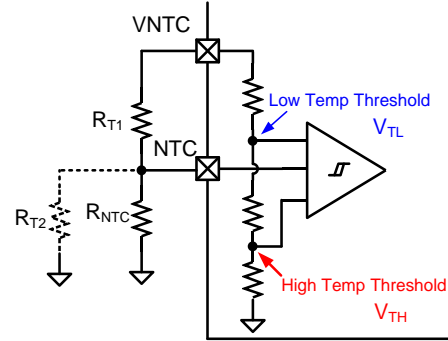

**Figure 16: NTC Function Block**

**Selecting the Inductor**

Inductor selection is a trade-off between cost, size, and efficiency. A lower inductance value corresponds with smaller size, but results in higher current ripple, higher magnetic hysteretic losses, and higher output capacitances. However, a higher inductance value benefits from lower ripple current and smaller output filter capacitors, but results in higher inductor DC resistance (DCR) loss.

Choose an inductor that does not saturate under the worst-case load condition.

When the MP2639A works in charge mode (as a boost converter), estimate the required inductance with Equation (27), Equation (28), and Equation (29):

$$L = \frac{V_{VL} \times (V_{VH} - V_{VL})}{V_{VH} \times f_{SW} \times \Delta I_{L\_MAX}} \quad (27)$$

$$\Delta I_{L\_MAX} = 30\% \times I_{VL(MAX)} \quad (28)$$

$$I_{VL(MAX)} = \frac{V_{VH} \times I_{VH(MAX)}}{V_{VL} \times \eta} \quad (29)$$

Where  $V_{VH}$  is the minimum battery voltage,  $f_{SW}$  is the switching frequency,  $\Delta I_{L\_MAX}$  is the peak-to-peak inductor ripple current (approximately 30% of the maximum input current ( $I_{VL(MAX)}$ )),



$I_{VH(MAX)}$  is the battery current (2.5A), and  $\eta$  is the efficiency.

Under most application conditions, the charge current is limited at the input current limit, so  $I_{VL(MAX)}$  is 3A, typically.

In the worst-case scenario with a 8.4V battery voltage, a 30% inductor current ripple, and a typical input voltage ( $V_{VL} = 5V$ ), the inductance is calculated as 1.9 $\mu$ H.

When the MP2639A works in discharge mode (as a buck converter), estimate the required inductance with Equation (30):

$$L = \frac{V_{VH} - V_{VL}}{\Delta I_{L\_MAX}} \times \frac{V_{VL}}{V_{VH} \times f_{SW}} \quad (30)$$

Where  $V_{VH}$  is the output voltage,  $V_{IN}$  is the input voltage,  $f_{SW}$  is the switching frequency, and  $\Delta I_{L\_MAX}$  is the maximum peak-to-peak inductor current (usually 30 - 40% of the discharge current).

With a typical 8.4V input voltage (2-cell battery), a 30% inductor current ripple at the max output current when  $V_{VL}$  is set at the typical 5V value ( $V_{VL} = 5V$ ,  $I_{VL(max)} = 5A$ ), and the inductance is calculated as 1.2 $\mu$ H.

For best results, use an inductor with an inductance of 2.2 $\mu$ H with a DC current rating no lower than the peak current of the MOSFET. For higher efficiency, minimize the inductor's DC resistance.

### Selecting the VL Capacitor ( $C_{VL}$ )

Select the VL capacitor ( $C_{VL}$ ) based on the demand of the system current ripple.

$C_{VL}$  is the input capacitor of the boost converter during charge mode and the output capacitor of the buck converter during discharge mode. Calculate its values with Equation (31) and Equation (32):

$$\Delta r_{VL} = \frac{\Delta V_{VL}}{V_{VL}} = \frac{1 - V_{VL} / V_{VH}}{8 \times C_{VL} \times f_{SW}^2 \times L} \quad (31)$$

$$C_{VL} = \frac{1 - V_{VL} / V_{VH\_MAX}}{8 \times \Delta r_{VL\_MAX} \times f_{SW}^2 \times L} \quad (32)$$

Suppose that the maximum VL ripple must not exceed 1% (e.g.: 0.5%). When  $V_{VH\_MAX}$  is 8.4V,  $V_{VL}$  is 5V, L is 2.2 $\mu$ H,  $f_{SW}$  is 1200kHz, and  $\Delta r_{VL\_MAX}$  is 0.5%, then  $C_{VL}$  is 3.2 $\mu$ F.

One 4.7 $\mu$ F ceramic capacitor with X7R dielectrics is sufficient.

### Selecting the VH Capacitor ( $C_{VH}$ )

The 2-cell battery is connected to the VH port, which is the output of the boost during charge mode and the input of the buck converter during discharge mode.

In discharge mode, the capacitor  $C_{VH}$  acts as the input capacitor of the buck converter. The input current ripple can be calculated with Equation (33):

$$I_{RMS\_MAX} = I_{VH\_MAX} \times \frac{\sqrt{V_{VL} \times (V_{VH\_MAX} - V_{VL})}}{V_{VH\_MAX}} \quad (33)$$

In boost mode, the capacitor ( $C_{VH}$ ) is the output capacitor of the boost converter.  $C_{VH}$  keeps the VH ripple small (<0.5%) and ensures feedback loop stability. The VH current ripple is given by Equation (29).

When  $I_{VH\_MAX}$  is 2.0A,  $V_{VL}$  is 5V, and  $V_{VH\_MAX}$  is 8.4V, the maximum ripple current is 1A. Select the system capacitors base on the ripple-current temperature rise, not to exceed 10°C. For best results, use X7R dielectric ceramic capacitors with low ESR and small temperature coefficients. For most applications, place two 22 $\mu$ F capacitors and one 1 $\mu$ F capacitor as close to the IC as possible.



## PCB Layout Guidelines

Efficient PCB layout is critical for meeting specified noise, efficiency, and stability requirements. For best results, follow the guidelines below.

1. Route the power stage adjacent to their grounds.
2. Minimize the length of high-side switching node (SW, inductor) trace that carries the high current.
3. Keep the switching node short and away from all control signals, especially the feedback network.
4. Place the input capacitor as close to VH and PGND as possible.
5. Place the local power input capacitors connected from VL to PGND as close to the IC as possible.
6. Place the output inductor close to the IC.
7. Connect the output capacitor between the inductor and PGND of the IC.
8. Connect the power pads for VH, VL, BATT, and PGND to as many copper planes on the board as possible for high-current applications.  
*This improves thermal performance because the board conducts heat away from the IC.*
9. Provide a ground plane for the PCB connected directly to the return of all components through vias (e.g.: two vias per capacitor for power-stage capacitors, one via per capacitor for small-signal components).  
*A star ground design approach is typically used to keep circuit block currents isolated (power signal/control signal), which reduces noise coupling and ground bounce issues. A single ground plane for this design gives good results.*
10. Place the ISET, OLIM and ILIM resistors very close to their respective IC pins.

**TYPICAL APPLICATION CIRCUITS**

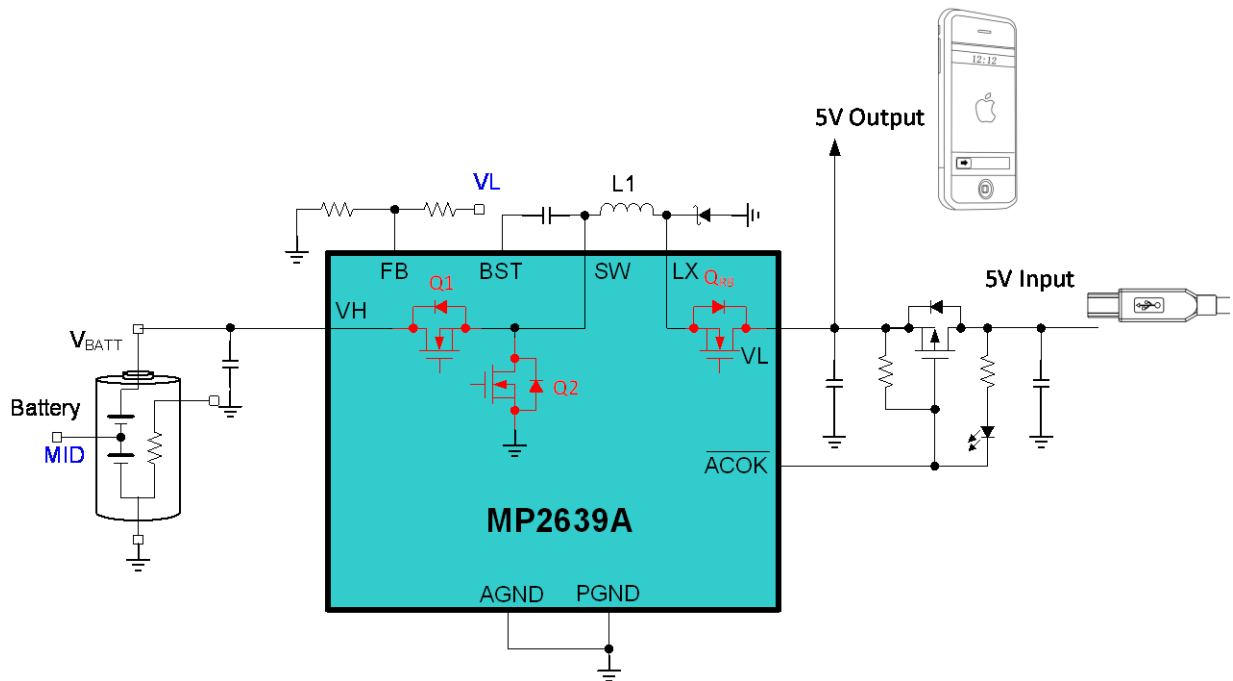

**Figure 17: Two-Port Application**

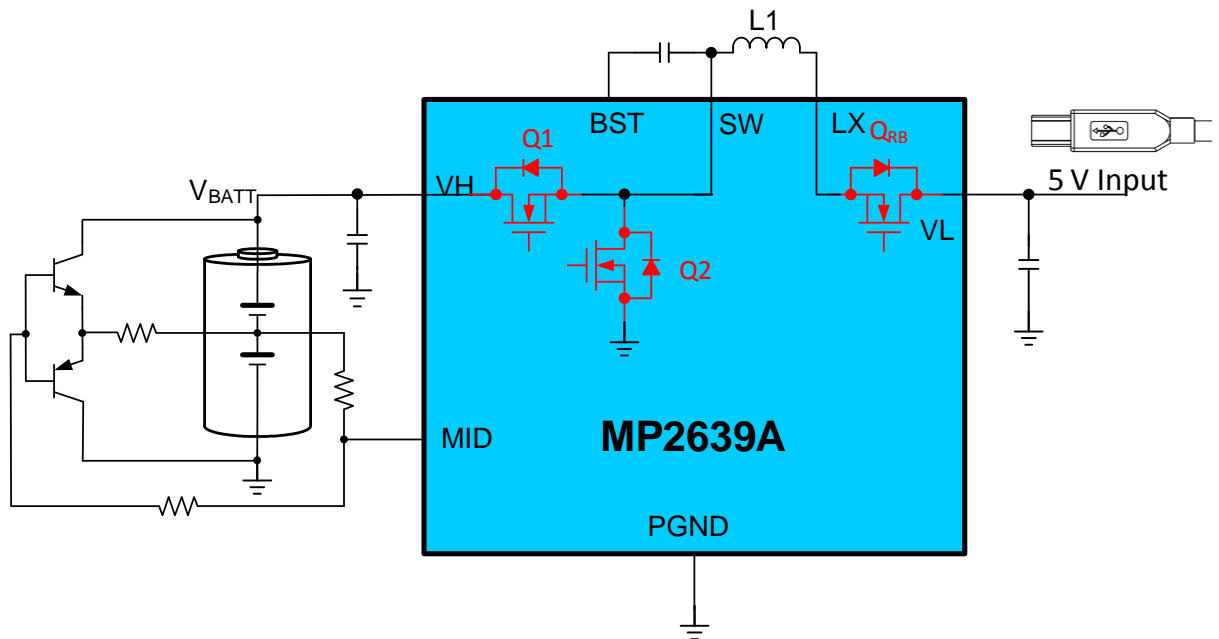

**Figure 18: Large Balance Current Application**

**PACKAGE INFORMATION**

**QFN-26 (4mmx4mm)**

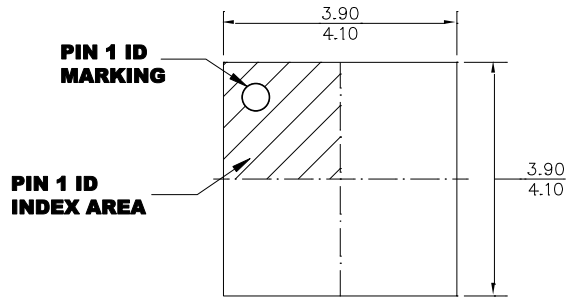

**TOP VIEW**

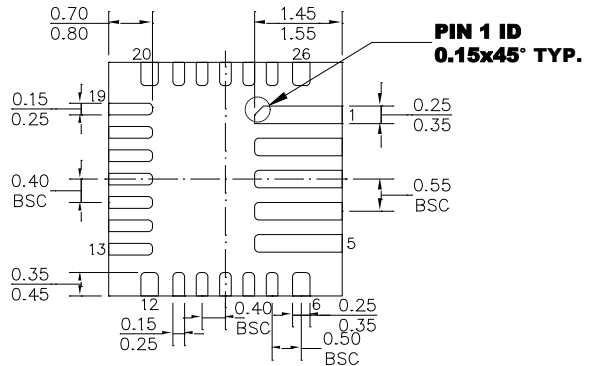

**BOTTOM VIEW**

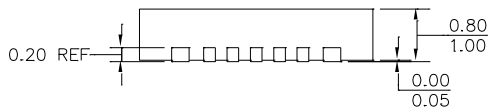

**SIDE VIEW**

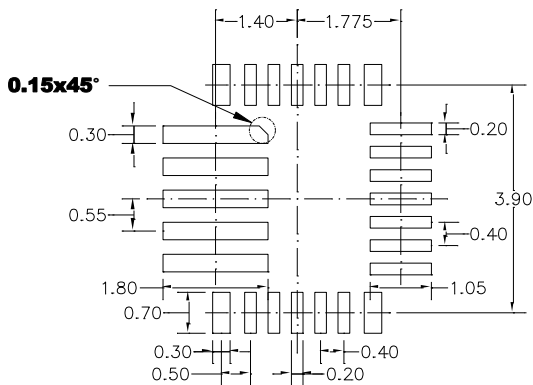

**RECOMMENDED LAND PATTERN**

**NOTE:**

- 1) ALL DIMENSIONS ARE IN MILLIMETERS.
- 2) LEAD COPLANARITY SHALL BE 0.10 MILLIMETERS MAX.
- 3) DRAWING CONFORMS TO JEDEC MO-220.
- 4) DRAWING IS NOT TO SCALE.

**NOTICE:** The information in this document is subject to change without notice. Please contact MPS for current specifications. Users should warrant and guarantee that third party Intellectual Property rights are not infringed upon when integrating MPS products into any application. MPS will not assume any legal responsibility for any said applications.