

# GP2S60

**SMT, Detecting Distance : 0.5mm  
Phototransistor Output,  
Compact Reflective  
Photointerrupter**



## ■ Description

**GP2S60** is a compact-package, phototransistor output, reflective photointerrupter, with emitter and detector facing the same direction in a molding that provides noncontact sensing. The compact package series is a result of unique technology, combing transfer and injection molding, that also blocks visible light to minimize false detection.

This photointerrupter can be ordered in different CTR ranks, and has a thin, leadless (T&R) package, suitable for reflow soldering.

## ■ Features

1. Reflective with Phototransistor Output
2. Highlights :
  - Compact Size
  - Surface Mount Type (SMT), reflow soldering
  - Tape and Reel (T&R) 2 000 pcs per reel
3. Key Parameters :
  - Optimal Sensing Distance : 0.5mm
  - Package : 3.2×1.7×1.1mm
  - Visible light cut resin to prevent
4. RoHS directive compliant

## ■ Agency approvals/Compliance

1. Compliant with RoHS directive

## ■ Applications

1. Detection of object presence or motion.
2. Any application, which production is migrating to 100% surface mount components.

Example : printer, optical storage

Notice The content of data sheet is subject to change without prior notice.  
In the absence of confirmation by device specification sheets, SHARP takes no responsibility for any defects that may occur in equipment using any SHARP devices shown in catalogs, data books, etc. Contact SHARP in order to obtain the latest device specification sheets before using any SHARP device.

■ Internal Connection Diagram

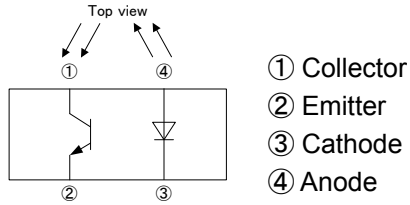

■ Outline Dimensions (Unit : mm)

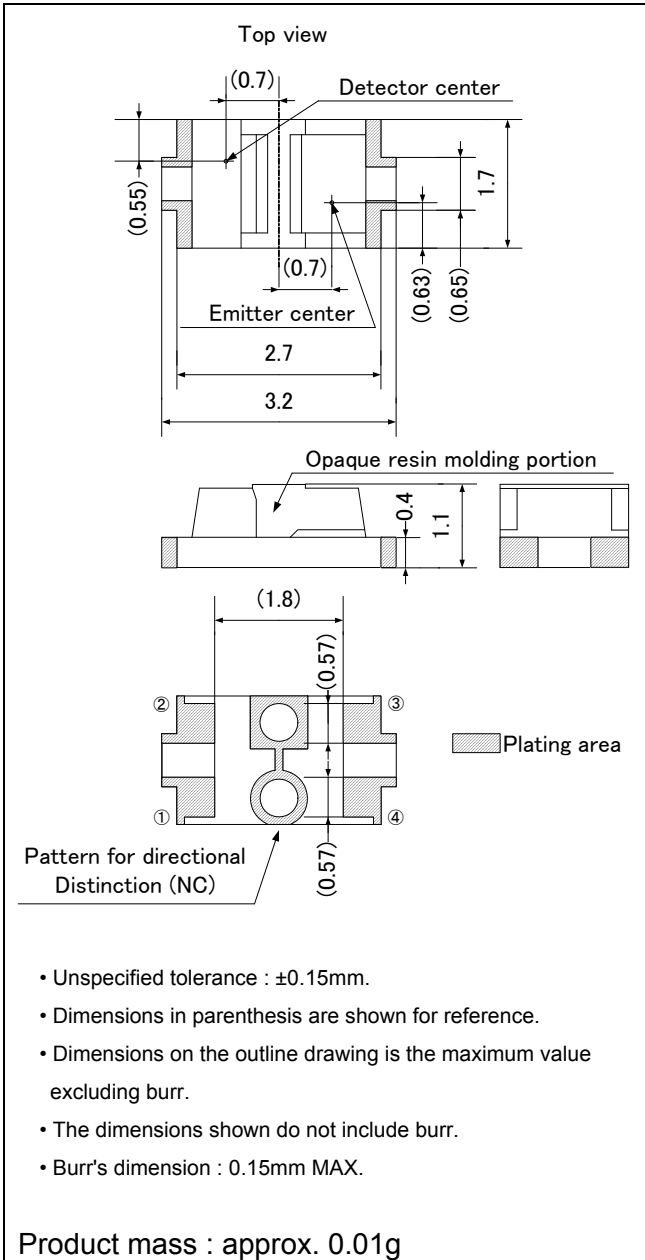

Plating material : Au

## ■ Absolute Maximum Ratings (T<sub>a</sub>=25°C)

| Parameter                |                             | Symbol           | Rating      | Unit |
|--------------------------|-----------------------------|------------------|-------------|------|
| Input                    | Forward current             | I <sub>F</sub>   | 50          | mA   |
|                          | Reverse voltage             | V <sub>R</sub>   | 6           | V    |
|                          | Power dissipation           | P <sub>D</sub>   | 75          | mW   |
| Output                   | Collector-emitter voltage   | V <sub>CEO</sub> | 35          | V    |
|                          | Emitter-collector voltage   | V <sub>ECO</sub> | 6           | V    |
|                          | Collector current           | I <sub>C</sub>   | 20          | mA   |
|                          | Collector power dissipation | P <sub>C</sub>   | 75          | mW   |
| Total power dissipation  |                             | P <sub>tot</sub> | 100         | mW   |
| Operating temperature    |                             | T <sub>opr</sub> | -25 to +85  | °C   |
| Storage temperature      |                             | T <sub>stg</sub> | -40 to +100 | °C   |
| *1 Soldering temperature |                             | T <sub>sol</sub> | 260         | °C   |

\*1 For 5s or less

## ■ Electro-optical Characteristics (T<sub>a</sub>=25°C)

| Parameter                |                        | Symbol            | Condition                                | MIN.  | TYP. | MAX. | Unit |
|--------------------------|------------------------|-------------------|--|---|------|------|------|
| Input                    | Forward voltage        | V <sub>F</sub>    | I <sub>F</sub> =20mA                     | -   | 1.2  | 1.4  | V    |
|                          | Reverse current        | I <sub>R</sub>    | V <sub>R</sub> =6V                       | -   | -    | 10   | μA   |
| Output                   | Collector dark current | I <sub>CEO</sub>  | V <sub>CE</sub> =20V                     | -   | 1    | 100  | nA   |
| Transfer characteristics | *2 Collector Current   | I <sub>C</sub>    | I <sub>F</sub> =4mA, V <sub>CE</sub> =2V | 40  | 85   | 130  | μA   |
|                          | *3 Leak current        | I <sub>LEAK</sub> | I <sub>F</sub> =4mA, V <sub>CE</sub> =2V | -   | -    | 500  | nA   |
|                          | Response time          | Rise time         | t <sub>r</sub>                           | V <sub>CE</sub> =2V, I <sub>C</sub> =100μA,<br>R <sub>L</sub> =1kΩ, d=1mm | -    | 20   | 100  |
| Fall time                |                        | t <sub>f</sub>    | -  |   | 20   | 100  |      |

\*2 The condition and arrangement of the reflective object are shown below.  
The rank splitting of collector current (I<sub>C</sub>) shall be executed according to the table below.

| Rank | Collector current, I <sub>C</sub> [μA]<br>(I <sub>F</sub> =4mA, V <sub>CE</sub> =2V) |
|------|--|
| A    | 40 to 80   |
| B    | 65 to 130  |

\*3 Without reflective object.

## ● Test Condition and Arrangement for Collector Current

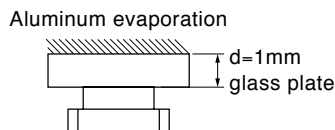

**■ Model Line-up**

| Model No.      | Rank   | I <sub>c</sub> (μA) | Conditions           |
|----------------|--------|---------------------|----------------------|
| <b>GP2S60</b>  | A or B | 40 to 130           | I <sub>F</sub> =4mA  |
| <b>GP2S60A</b> | A      | 40 to 80            | V <sub>CE</sub> =2V  |
| <b>GP2S60B</b> | B      | 65 to 130           | T <sub>a</sub> =25°C |

Please contact a local SHARP sales representative to see the actual status of the production.

**Fig.1 Forward Current vs. Ambient Temperature**

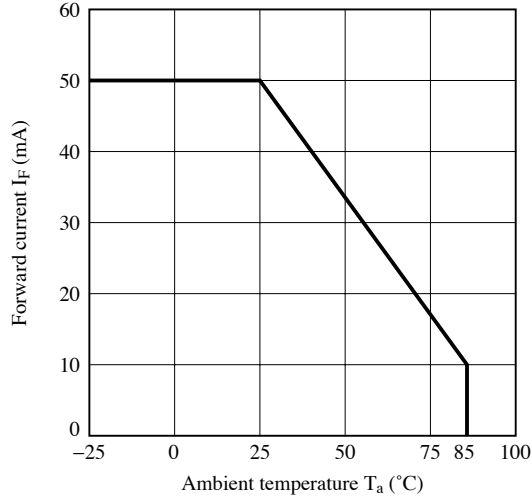

**Fig.2 Power Dissipation vs. Ambient Temperature**

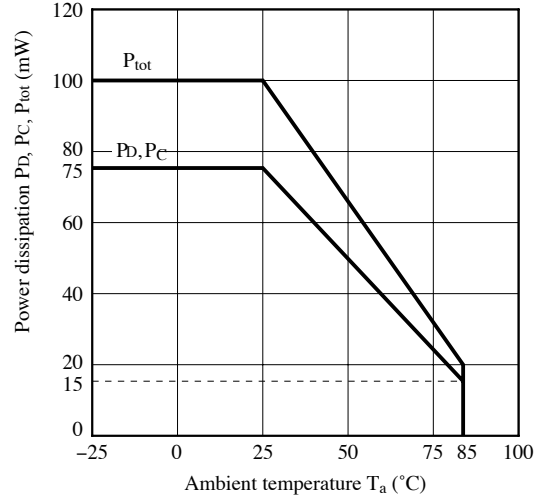

**Fig.3 Forward Current vs. Forward Voltage**

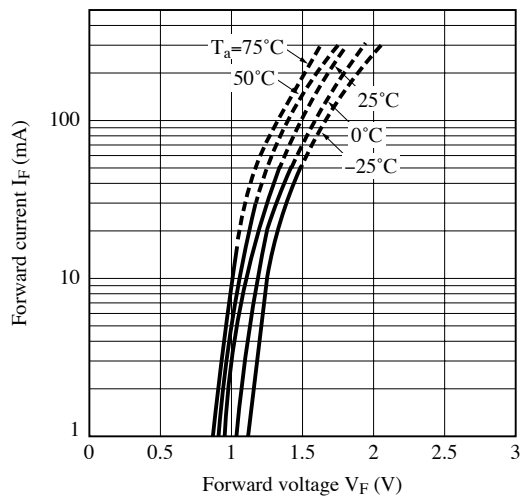

**Fig.4 Collector Current vs. Forward Current**

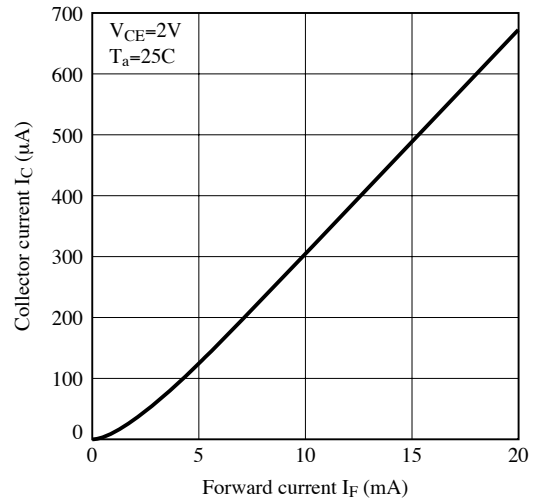

**Fig.5 Collector Current vs. Collector-Emitter Voltage**

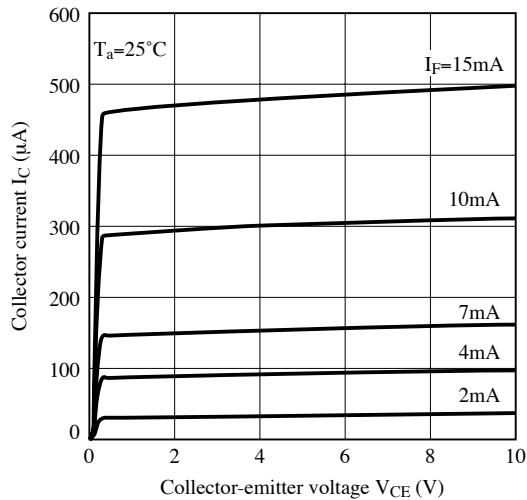

**Fig.6 Relative Collector Current vs. Ambient Temperature**

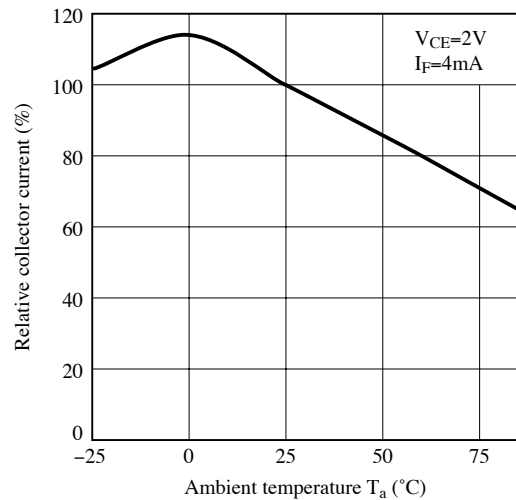

**Fig.7 Collector Dark Current vs. Ambient Temperature**

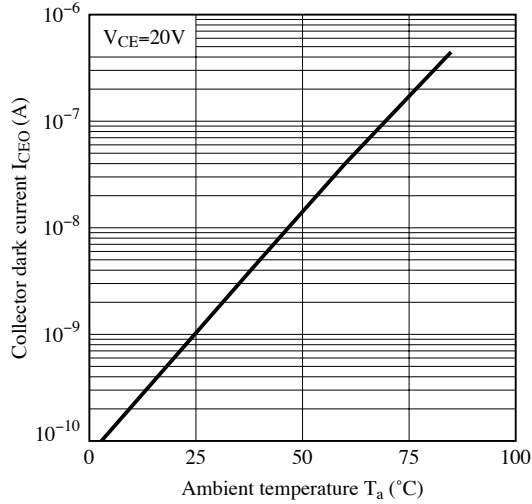

**Fig.8 Response Time vs. Load Resistance**

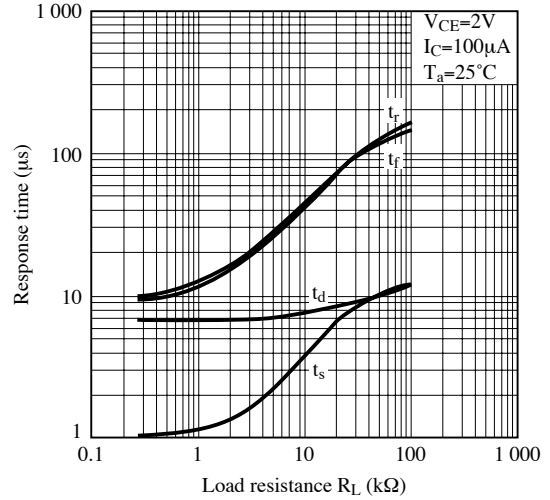

**Fig.9 Test Circuit for Response Time**

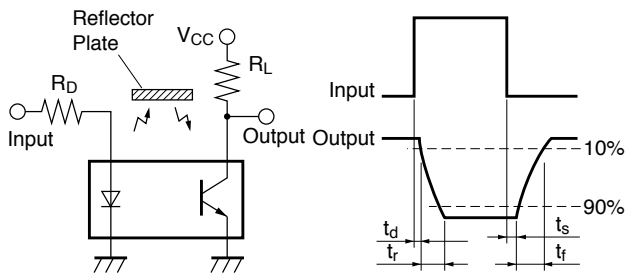

**Fig.10 Relative Collector Current vs. Distance**

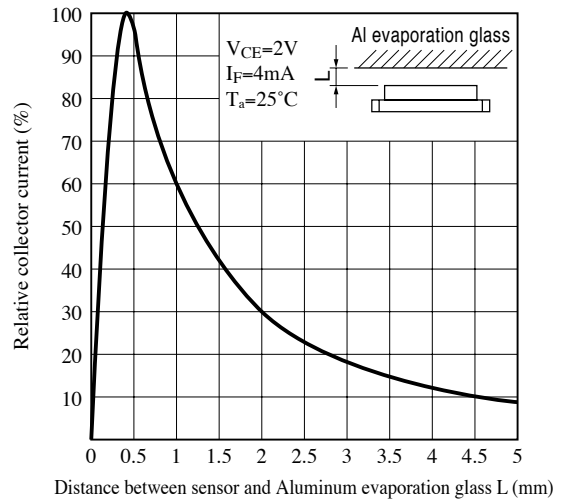

**Fig.11 Spectral Sensitivity**

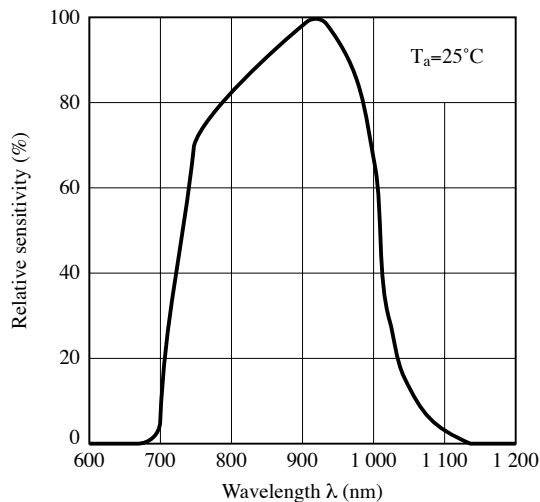

**Fig.12 Detecting Position Characteristics (1)**

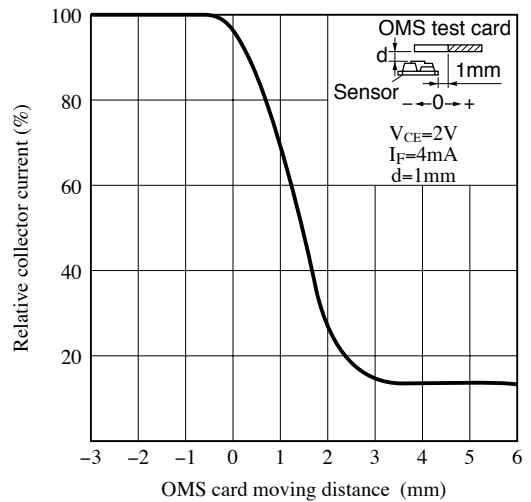

**Fig.13 Detecting Position Characteristics (2)**

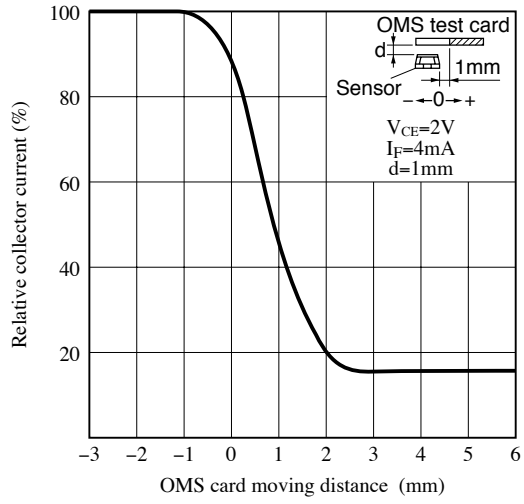

Remarks : Please be aware that all data in the graph are just for reference and not for guarantee.

■ **Design Considerations**

● **Design guide**

- 1) Regarding to prevention of malfunction  
To prevent photointerrupter from faulty operation caused by external light, do not set the detecting face to the external light.
- 2) Distance characteristic  
The distance between the photointerrupter and the object to be detected shall be determined the distance by referencing Fig.10 "Relative collector current vs. distance".
- 3) For wiring on a mounting PCB  
To avoid possibility for short, please do not apply pattern wiring on the back side of the device.
- 4) Regarding to mounting this product  
There is a possibility that the opaque molded resin portion may have a crack by force at mounting etc. Please use this product after well confirmation of conditions in your production line.

This product is not designed against irradiation and incorporates non-coherent IRED.

● **Degradation**

In the case of long term operation, please take the general IRED degradation (50% degradation over 5 years) into the design consideration.

● **Parts**

This product is assembled using the below parts.

• **Light detector (qty. : 1)**

| Category        | Material     | Maximum Sensitivity wavelength (nm) | Sensitivity wavelength (nm) | Response time (μs) |
|-----------------|--------------|-------------------------------------|-----------------------------|--------------------|
| Phototransister | Silicon (Si) | 930                                 | 700 to 1 200                | 20                 |

• **Light emitter (qty. : 1)**

| Category                               | Material                | Maximum light emitting wavelength (nm) | I/O Frequency (MHz) |
|--|-------------------------|--|---------------------|
| Infrared emitting diode (non-coherent) | Gallium arsenide (GaAs) | 950                                    | 0.3                 |

• **Material**

| Case                                       | PCB               | Lead frame plating |
|--|-------------------|--------------------|
| Epoxy resin<br>Black polyphenylene sulfide | Glass epoxy resin | Au plating         |



● Recommended pattern

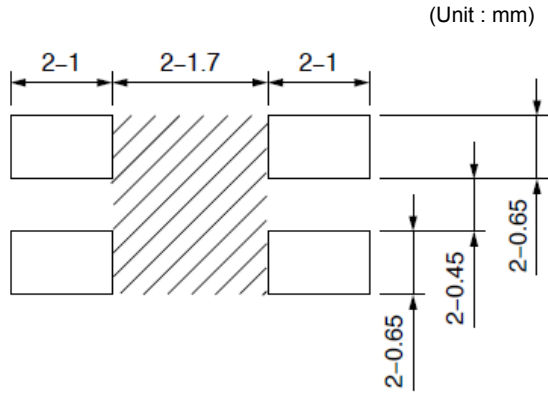

measure tolerance :  $\pm 0.1$

 area : Please do not apply the pattern wiring to avoid the possibility of short circuit.

Regarding amount of solder, if there is solder leakage in terminal wiring pattern between PCB and housing main body, the reliability will be deteriorated.

Please check the proper amount of solder in advance not to have solder leakage into terminal wiring pattern between PCB and housing main body.

---

**■ Manufacturing Guidelines****● Storage and management after open****Storage condition**

Storage temp.: 5 to 30°C, Storage humidity : 70%RH or less at regular packaging.

**Treatment after opening the moisture-proof package**

After opening, you should mount the products while keeping them on the condition of 5 to 25°C and 60%RH or less in humidity within 2 days.

After opening the bag once even if the prolonged storage is necessary, you should mount the products within two weeks.

And when you store the rest of products you should put into a DRY BOX. Otherwise after the rest of products and silicagel are sealed up again, you should keep them under the condition of 5 to 30°C and 70%RH or less in humidity.

**Baking before mounting**

When the above-mentioned storage method could not be executed, please process the baking treatment before mounting the products.

However the baking treatment is permitted within one time.

Recommended condition : 125°C, 16 to 24 hours

\*Do not process the baking treatment with the product wrapped. When the baking treatment processing, you should move the products to a metallic tray or fix temporarily the products to substrate.

● **Soldering Method**

Reflow Soldering:

Reflow soldering should follow the temperature profile shown below.  
 Soldering should not exceed the curve of temperature profile and time.  
 Please solder within one time.

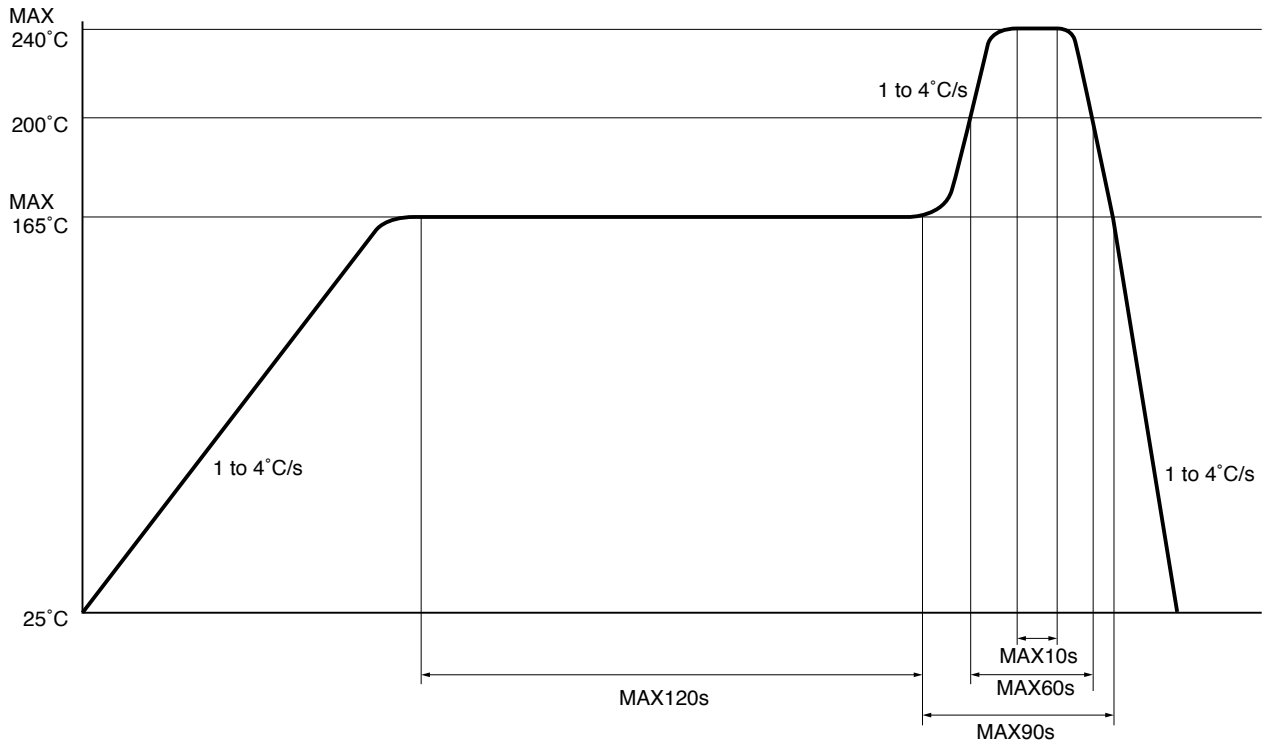

Other notice

Please take care not to let any external force exert on lead pins.  
 Please test the soldering method in actual condition and make sure the soldering works fine, since the impact on the junction between the device and PCB varies depending on the cooling and soldering conditions.

● **Cleaning instructions**

Solvent cleaning :

Solvent temperature should be 45°C or below. Immersion time should be 3 minutes or less.

Ultrasonic cleaning :

Do not execute ultrasonic cleaning.

Recommended solvent materials :

Ethyl alcohol, Methyl alcohol and Isopropyl alcohol.

● **Presence of ODC**

This product shall not contain the following materials.

And they are not used in the production process for this product.

Regulation substances : CFCs, Halon, Carbon tetrachloride, 1.1.1-Trichloroethane (Methylchloroform)

Specific brominated flame retardants such as the PBBOs and PBBs are not used in this product at all.

This product shall not contain the following materials banned in the RoHS Directive (2002/95/EC).

- Lead, Mercury, Cadmium, Hexavalent chromium, Polybrominated biphenyls (PBB), Polybrominated diphenyl ethers (PBDE).

Content of six substances specified in Management Methods for Control of Pollution Caused by Electronic Information Products Regulation (Chinese : 电子信息产品污染控制管理办法).

| Category         | Toxic and hazardous substances |              |              |   |                                |                                       |
|------------------|--------------------------------|--------------|--------------|---|--------------------------------|---------------------------------------|
|                  | Lead (Pb)                      | Mercury (Hg) | Cadmium (Cd) | Hexavalent chromium (Cr <sup>6+</sup> ) | Polybrominated biphenyls (PBB) | Polybrominated diphenyl ethers (PBDE) |
| Photointerrupter | ✓                              | ✓            | ✓            | ✓                                       | ✓                              | ✓                                     |

✓ : indicates that the content of the toxic and hazardous substance in all the homogeneous materials of the part is below the concentration limit requirement as described in SJ/T 11363-2006 standard.

■ **Package specification**

● **Tape and Reel package**

Package materials

Carrier tape : PS (with anti-static material)

Reel : PS

Package method

2 000 pcs of products shall be packaged in a reel. One reel is encased in aluminum laminated bag.

After sealing up the bag, it is encased in one case (5 bags/case).

Carrier tape structure and Dimensions

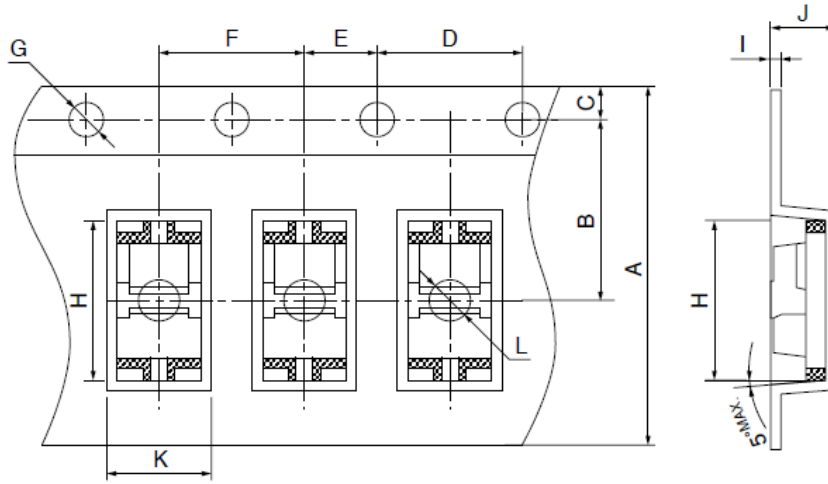

| Dimensions List        |                  |                  |                  |                 |                      | (Unit: mm) |
|------------------------|------------------|------------------|------------------|-----------------|----------------------|------------|
| A                      | B                | C                | D                | E               | F                    |            |
| $8^{\pm 0.3}$          | $3.5^{\pm 0.05}$ | $1.75^{\pm 0.1}$ | $4^{\pm 0.1}$    | $2^{\pm 0.1}$   | $4^{\pm 0.1}$        |            |
| G                      | H                | I                | J                | K               | L                    |            |
| $\Phi 1.55^{\pm 0.05}$ | $3.6^{\pm 0.1}$  | $0.3^{\pm 0.05}$ | $1.25^{\pm 0.1}$ | $2.2^{\pm 0.1}$ | $\Phi 1.1^{\pm 0.1}$ |            |

Reel structure and Dimensions

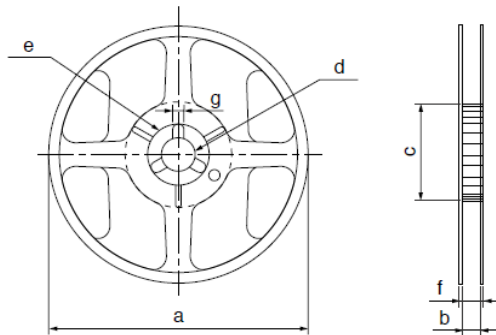

| Dimensions List     |                  |                  |                     | (Unit: mm) |
|---------------------|------------------|------------------|---------------------|------------|
| a                   | b                | c                | d                   |            |
| $180^{\pm 2.0}$     | $9^{\pm 1.0}$    | $60^{+0.5}_{-0}$ | $\Phi 13^{\pm 0.2}$ |            |
| e                   | f                | g                |                     |            |
| $\Phi 21^{\pm 0.8}$ | $11.4^{\pm 1.0}$ | $2^{+0.3}_{-0}$  |                     |            |

### Direction of product insertion

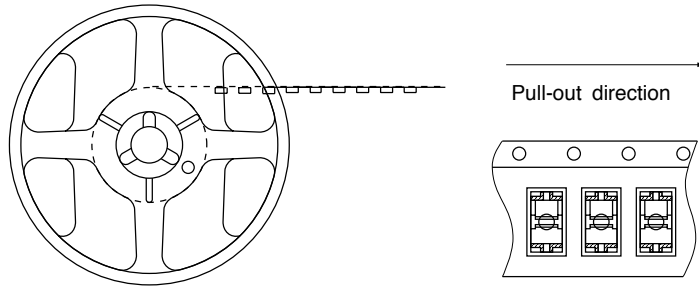

[Packing : 2 000pcs/reel]

### Storage method

Storage conditions should follow the condition shown below.

Storage temperature : 5 to 30°C

Storage humidity : 70%RH or less

## ■ Important Notices

· The circuit application examples in this publication are provided to explain representative applications of SHARP devices and are not intended to guarantee any circuit design or license any intellectual property rights. SHARP takes no responsibility for any problems related to any intellectual property right of a third party resulting from the use of SHARP's devices.

· Contact SHARP in order to obtain the latest device specification sheets before using any SHARP device. SHARP reserves the right to make changes in the specifications, characteristics, data, materials, structure, and other contents described herein at any time without notice in order to improve design or reliability. Manufacturing locations are also subject to change without notice.

· These specification sheets include materials protected under copyright of Sharp Corporation ("Sharp"). Please do not reproduce or cause anyone to reproduce them without Sharp's consent.

· When using this product, please observe the absolute maximum ratings and the instructions for use outlined in these specification sheets, as well as the precautions mentioned below. Sharp assumes no responsibility for any damage resulting from use of the product which does not comply with the absolute maximum ratings and the instructions included in these specification sheets, and the precautions mentioned below.

Please do verify the validity of this part after assembling it in customer's products, when customer wants to make catalogue and instruction manual based on the specification sheet of this part.

(Precautions)

(1) This product is designed for use in the following application areas ;

- OA equipment · Audio visual equipment
- Home appliances

- Telecommunication equipment (Terminal)
- Measuring equipment
- Tooling machines · Computers

If the use of the product in the above application areas is for equipment listed in paragraphs (2) or (3), please be sure to observe the precautions given in those respective paragraphs.

(2) Appropriate measures, such as fail-safe design and redundant design considering the safety design of the overall system and equipment, should be taken to ensure reliability and safety when this product is used for equipment which demands high reliability and safety in function and precision, such as ;

- Transportation control and safety equipment (aircraft, train, automobile etc.)
- Traffic signals · Gas leakage sensor breakers
- Rescue and security equipment
- Other safety equipment

(3) Please do not use this product for equipment which require extremely high reliability and safety in function and precision, such as ;

- Space equipment
- Telecommunication equipment (for trunk lines)
- Nuclear power control equipment · Medical equipment
- Power generation and power transmission control system (Key system)

(4) Please contact and consult with a Sharp sales representative if there are any questions regarding interpretation of the above four paragraphs.

- Please contact and consult with a Sharp sales representative for any questions about this product.

· If the SHARP devices listed in this publication fall within the scope of strategic products described in the Foreign Exchange and Foreign Trade Law of Japan, it is necessary to obtain approval to export such SHARP devices.