

WiFi 4 click board™ Schematic v101

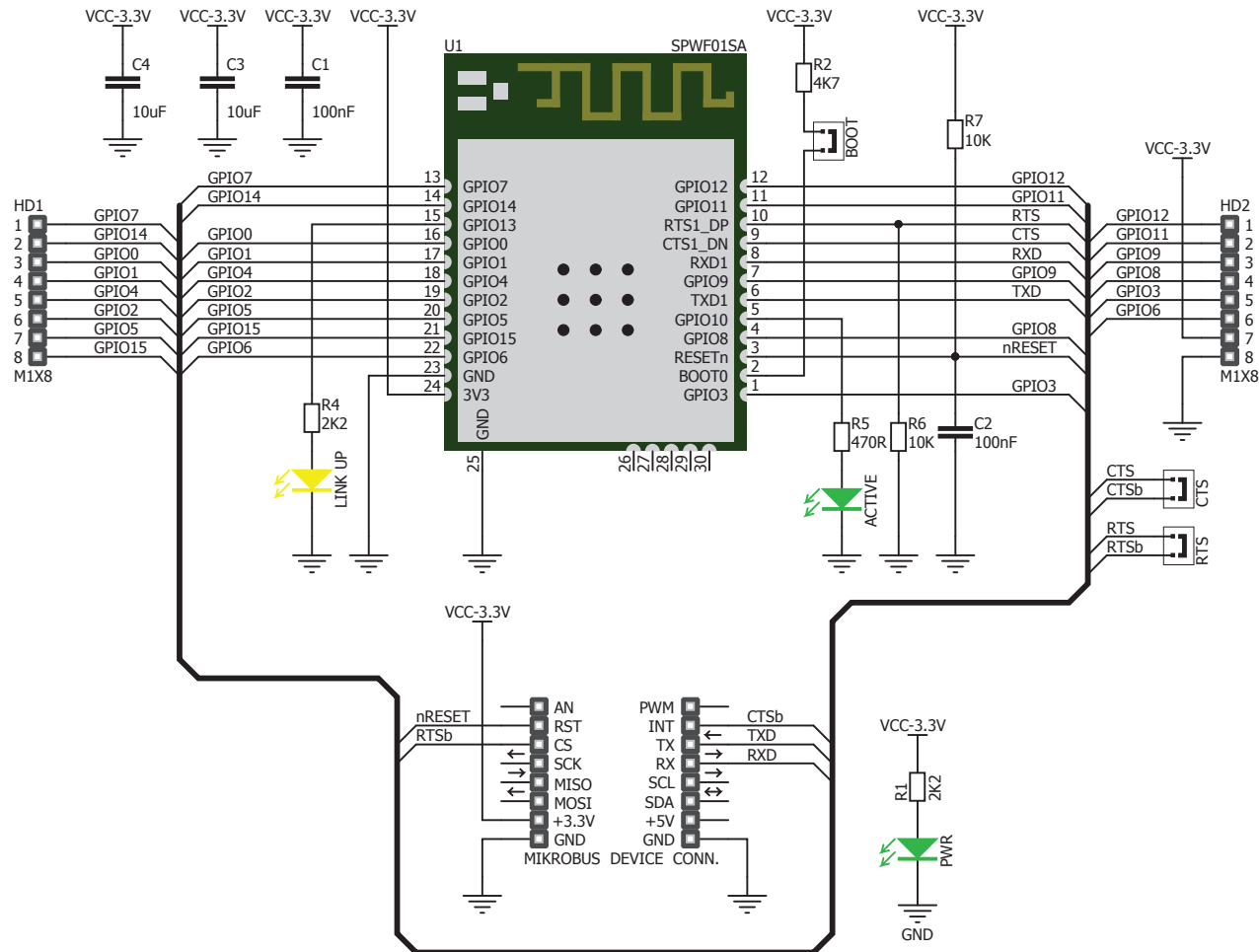

www.mikroe.com