

THIS DRAWING IS UNPUBLISHED. RELEASED FOR PUBLICATION 20  
 © COPYRIGHT 20 BY - ALL RIGHTS RESERVED.

LOC		DIST		REVISIONS			
P	LTR	DESCRIPTION	DATE	DWN	APVD		
	DI	REVISED PER ECO-12-016948	30OCT2012	KH	MB		

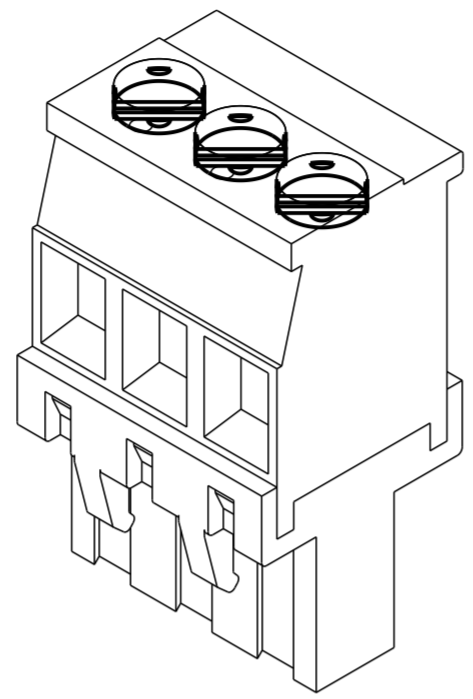
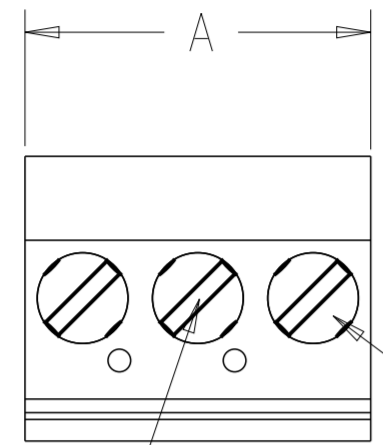

- 1. MATERIALS AND FINISH:  
 HOUSING: PA 6-6, UL 94-V0, COLOR: SEE TABLE.  
 CLAMP: BRASS, NICKEL PLATED.  
 CONTACT SPRING: PHOSPHOR BRONZE, FINISH: SEE TABLE.  
 CLAMPING SCREW: M3, BRASS, NICKEL PLATED.
- 2. WIRE SIZE RANGE: 12-30 AWG.
- 3. NOT CUMULATIVE TOLERANCE.
- 4. INK MARKING, BLACK COLOR.
- 5. INK MARKING, WHITE COLOR.

CLAMPING SCREW  
 BLOCKED CAVITY

284051-2 AS SHOWN

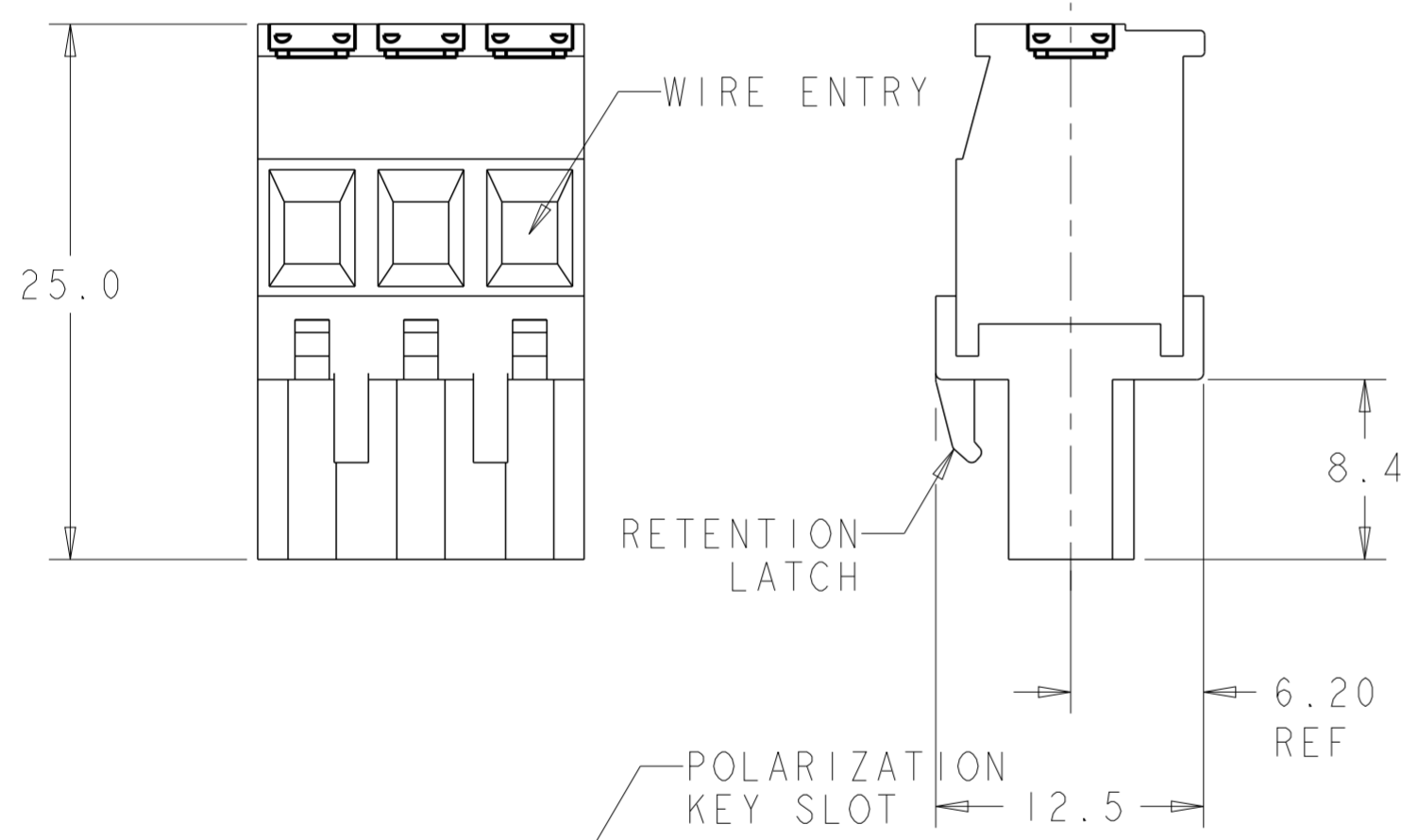

PRELIMINARY	SEE DETAIL T	TIN PLATED	BLACK	35.56	4	1-284051-7
	SEE DETAIL T	TIN PLATED	GREEN	35.56	4	1-284051-6
OBSOLETE	SEE DETAIL S	0.00076 SELECT GOLD	GREEN	15.24	2	1-284051-5
OBSOLETE	-	0.00076 SELECT GOLD	GREEN	15.24	2	1-284051-4
	-	TIN PLATED	GREEN	127.00	13	1-284051-3
	-	TIN PLATED	GREEN	116.84	12	1-284051-2
	-	TIN PLATED	GREEN	106.68	11	1-284051-1
	-	TIN PLATED	GREEN	96.52	10	1-284051-0
	-	TIN PLATED	GREEN	86.36	9	284051-9
	-	TIN PLATED	GREEN	76.20	8	284051-8
	-	TIN PLATED	GREEN	66.04	7	284051-7
	-	TIN PLATED	GREEN	55.88	6	284051-6
	-	TIN PLATED	GREEN	45.72	5	284051-5
	-	TIN PLATED	GREEN	35.56	4	284051-4
	-	TIN PLATED	GREEN	25.40	3	284051-3
	-	TIN PLATED	GREEN	15.24	2	284051-2

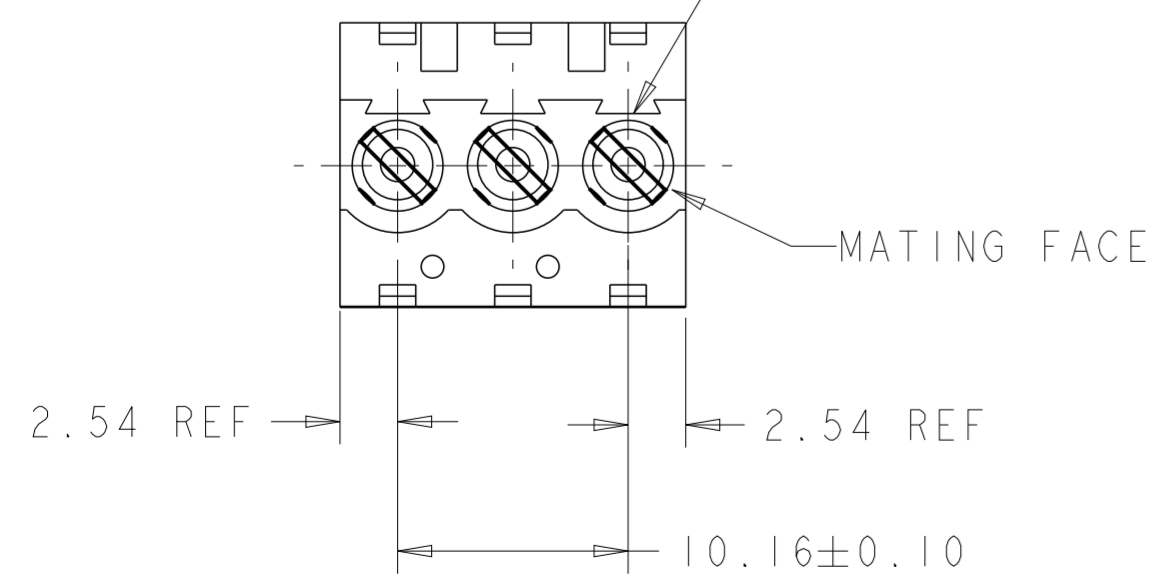

MARKING	CONTACT FINISH	HOUSING COLOR	A	NO OF POSN	PART NUMBER

THIS DRAWING IS A CONTROLLED DOCUMENT.		DWN S. WELDON 16NOV2005	TE Connectivity			
DIMENSIONS: mm		CHK C. RICHARD 16NOV2005				
TOLERANCES UNLESS OTHERWISE SPECIFIED:		APVD C. RICHARD 16NOV2005				
0 PLC ±0.3 1 PLC ±0.25 2 PLC ±0.25 3 PLC ±0.000 4 PLC ±0.000 ANGLES ±2° FINISH		NAME				
MATERIAL		PRODUCT SPEC	TERMINAL BLOCK, VERTICAL, PLUG, STACKING, RIGHT HAND, 10.16mm PITCH			
		APPLICATION SPEC	SIZE	CAGE CODE	DRAWING NO	RESTRICTED TO
		WEIGHT	A2	00779	C-284051	-
		CUSTOMER DRAWING	SCALE	3:1	SHEET	1 OF 2
						REV DI

THIS DRAWING IS UNPUBLISHED. RELEASED FOR PUBLICATION 20  
 © COPYRIGHT 20 BY - ALL RIGHTS RESERVED.

LOC	DIST	REVISIONS					
FT	0	P	LTR	DESCRIPTION	DATE	DWN	APVD
		-		SEE SHEET 1	-	-	-

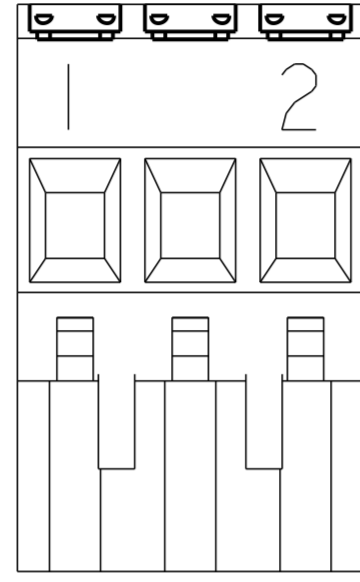

△<sub>4</sub>  
 DETAIL S

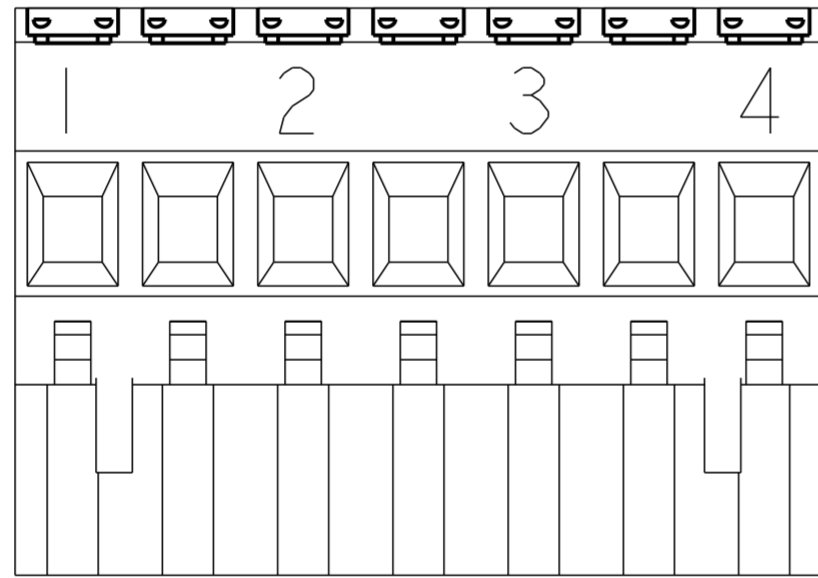

△<sub>5</sub>  
 DETAIL T

THIS DRAWING IS A CONTROLLED DOCUMENT.		DWN S. WELDON 16NOV2005	 TE Connectivity	
DIMENSIONS: mm		CHK C. RICHARD 16NOV2005		
TOLERANCES UNLESS OTHERWISE SPECIFIED:		APVD C. RICHARD 16NOV2005	NAME TERMINAL BLOCK, VERTICAL, PLUG, STACKING, RIGHT HAND, 10.16mm PITCH	
0 PLC ± 1 PLC ±0.3 2 PLC ±0.25 3 PLC ±0.000 4 PLC ±0.0000 ANGLES ±2° FINISH		PRODUCT SPEC -	SIZE A200779	CAGE CODE C-284051
MATERIAL -		APPLICATION SPEC -	DRAWING NO -	RESTRICTED TO -
		WEIGHT -	SCALE 3:1 SHEET 2 OF 2 REV D1	
		CUSTOMER DRAWING		