

TCV7103AF

Buck DC-DC Converter IC

The TCV7103AF is a single-chip buck DC-DC converter IC. The TCV7103AF contains high-speed and low-on-resistance power MOSFETs to achieve synchronous rectification using an external low-side MOSFET, or rectification using an external diode, allowing for high efficiency.

Features

- Enables up to 6.5A (@ $V_{IN} = 5V$)/6A (@ $V_{IN} = 3.3V$) of load current (I_{OUT}) with a minimum of external components.
- High efficiency: $\eta = 95\%$ (typ.) (@ $V_{IN} = 5V, V_{OUT} = 3.3V, I_{OUT} = 2A$) (when using the SSM6K411TU as a low-side MOSFET)
- Operating voltage range: $V_{IN} = 2.7V$ to 5.6V
- Low ON-resistance: $R_{DS(ON)} = 0.08\Omega$ (high-side) typical (@ $V_{IN} = 5V, T_j = 25^\circ C$)
- Oscillation frequency: $f_{OSC} = 1000kHz$ (typ.)
- Feedback voltage: $V_{FB} = 0.8V \pm 1\%$ (@ $T_j = 0$ to $85^\circ C$)
- Incorporates an N-channel MOSFET driver for synchronous rectification
- Uses internal phase compensation to achieve high efficiency with a minimum of external components.
- Allows the use of a small surface-mount ceramic capacitor as an output filter capacitor.
- Housed in a small surface-mount package (SOP Advance) with a low thermal resistance.
- Soft-start time adjustable by an external capacitor
- Overcurrent protection (OCP) with latch function

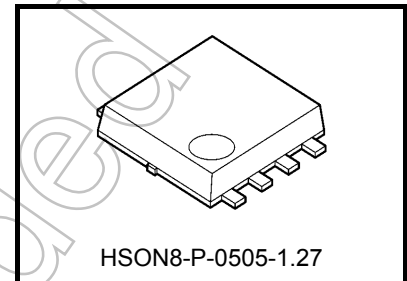

Weight: 0.068 g (typ.)

Part Marking

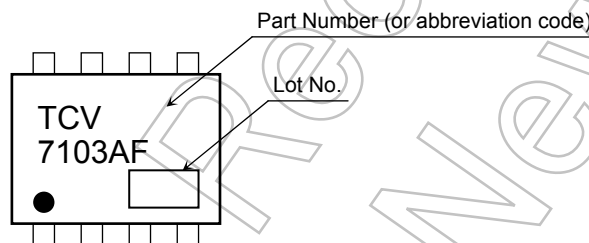

The dot (•) on the top surface indicates pin 1.

Pin Assignment

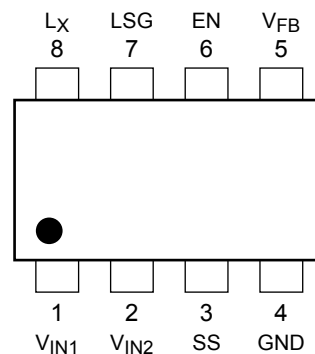

*: The lot number consists of three digits. The first digit represents the last digit of the year of manufacture, and the following two digits indicates the week of manufacture between 01 and either 52 or 53.



Manufacturing week code
(The first week of the year is 01; the last week is 52 or 53.)
Manufacturing year code (last digit of the year of manufacture)

This product has a MOS structure and is sensitive to electrostatic discharge. Handle with care.

The product(s) in this document (“Product”) contain functions intended to protect the Product from temporary small overloads such as minor short-term overcurrent, or overheating. The protective functions do not necessarily protect Product under all circumstances. When incorporating Product into your system, please design the system (1) to avoid such overloads upon the Product, and (2) to shut down or otherwise relieve the Product of such overload conditions immediately upon occurrence. For details, please refer to the notes appearing below in this document and other documents referenced in this document.

Start of commercial production
2010-08

Ordering Information

Part Number	Shipping
TCV7103AF (TE12L, Q)	Embossed tape (3000 units per reel)

Block Diagram

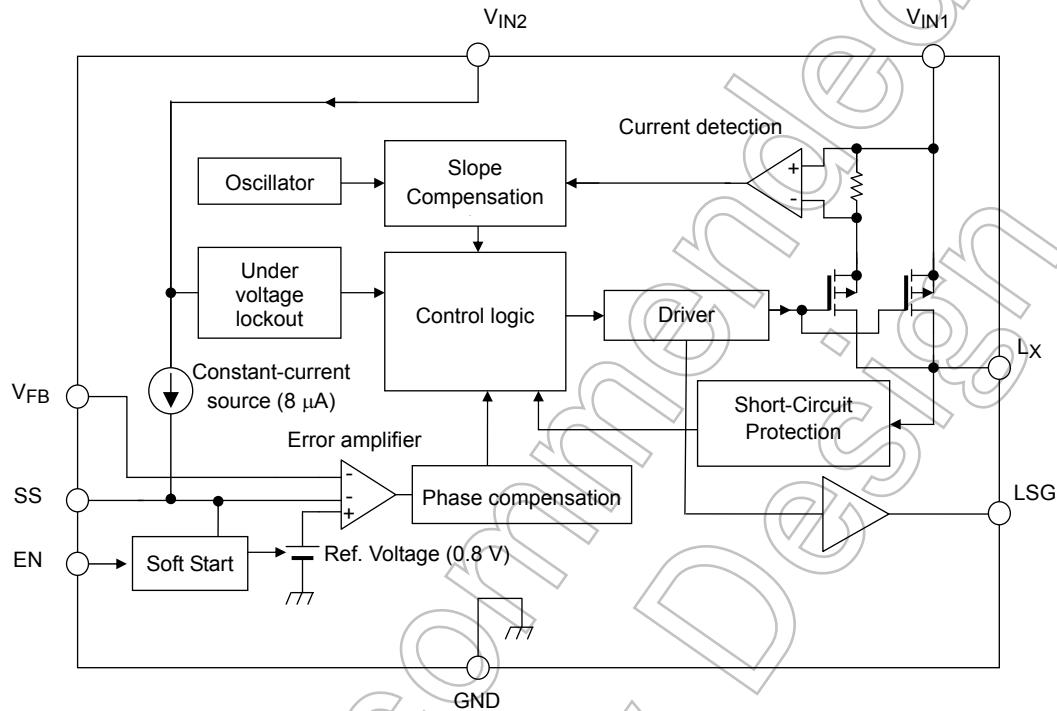

Pin Description

Pin No.	Symbol	Description
1	V _{IN1}	Input pin for the output section This pin is placed in the standby state if V _{EN} = L. Standby current is 10μA or less.
2	V _{IN2}	Input pin for the control section This pin is placed in the standby state if V _{EN} = L. Standby current is 10μA or less.
3	SS	Soft-start pin When the SS input is left open, the soft-start time is 1ms (typ.). The soft-start time can be adjusted with an external capacitor. The external capacitor is charged from a 8μA (typ.) constant-current source, and the reference voltage of the error amplifier is regulated between 0 V and 0.8 V. The external capacitor is discharged when EN = L and in case of undervoltage lockout or thermal shutdown.
4	GND	Ground pin
5	V _{FB}	Feedback pin This input is fed into an internal error amplifier with a reference voltage of 0.8V (typ.).
6	EN	Enable pin When EN ≥ 1.5V (@ V _{IN} = 5V), the internal circuitry is allowed to operate and thus enable the switching operation of the output section. When EN ≤ 0.5V (@ V _{IN} = 5V), the internal circuitry is disabled, putting the TCV7103AF in Standby mode. Standby current is 10 μA or less. This pin has an internal pull-down resistor of approx. 500kΩ.
7	LSG	Gate drive pin for the low-side switch
8	L _X	Switch pin This pin is connected to high-side P-channel MOSFET.

Absolute Maximum Ratings (Ta = 25°C)

Characteristics	Symbol	Rating	Unit
Input pin voltage for the output section(Note 1)	V _{IN1}	-0.3 to 7	V
Input pin voltage for the control section(Note 1)	V _{IN2}	-0.3 to 7	V
Soft-start pin voltage(Note 1)	V _{SS}	-0.3 to 7	V
Feedback pin voltage(Note 1)	V _{F_{FB}}	-0.3 to 7	V
Enable pin voltage(Note 1)	V _{EN}	-0.3 to 7	V
V _{EN} - V _{IN2} voltage difference	V _{EN} -V _{IN2}	V _{EN} - V _{IN2} < 0.3	V
LSG pin voltage(Note 1)	V _{LSG}	-0.3 to 7	V
Switch pin voltage(Note 2)	V _{LX}	-0.3 to 7	V
Switch pin current	I _{LX}	-7.8	A
Power dissipation(Note 3)	P _D	2.2	W
Operating junction temperature	T _{jopr}	-40 to 125	°C
Junction temperature(Note 4)	T _j	150	°C
Storage temperature	T _{stg}	-55 to 150	°C

Note: Using continuously under heavy loads (e.g. the application of high temperature/current/voltage and the significant change in temperature, etc.) may cause this product to decrease in the reliability significantly even if the operating conditions (i.e. operating temperature/current/voltage, etc.) are within the absolute maximum ratings and the operating ranges.

Please design the appropriate reliability upon reviewing the Toshiba Semiconductor Reliability Handbook (“Handling Precautions”/“Derating Concept and Methods”) and individual reliability data (i.e. reliability test report and estimated failure rate, etc)

Note 1: Using this product continuously may cause a decrease in the reliability significantly even if the operating conditions are within the absolute maximum ratings. Set each pin voltage less than 5.6V taking into consideration the derating.

Note 2: The switch pin voltage (V_{LX}) doesn't include the peak voltage generated by TCV7103AF's switching. A negative voltage generated in dead time is permitted among the switch pin current (I_{LX}).

Thermal Resistance Characteristics

Characteristics	Symbol	Max	Unit
Thermal resistance, junction to ambient	R _{th(j-a)}	44.6 (Note 3)	°C/W
Thermal resistance, junction to case (Tc=25°C)	R _{th(j-c)}	4.17	°C/W

Note 3:

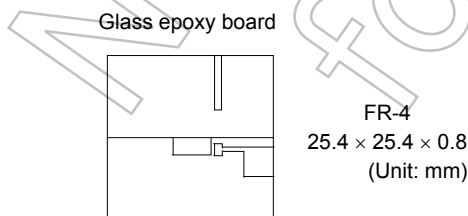

Single-pulse measurement: pulse width t=10(s)

Note 4: The TCV7103AF may enter into thermal shutdown at the rated maximum junction temperature. Thermal design is required to ensure that the rated maximum operating junction temperature, T_{jopr}, will not be exceeded.

Electrical Characteristics (T_j = 25°C, V_{IN1} = V_{IN2} = 2.7V to 5.6 V, unless otherwise specified)

Characteristics	Symbol	Test Condition	Min	Typ.	Max	Unit	
Operating input voltage	V _{IN (OPR)}	—	2.7	—	5.6	V	
Operating current	I _{IN}	V _{IN1} = V _{IN2} = V _{EN} = V _{FB} = 5V	—	530	780	μA	
Output voltage range	V _{OUT(OPR)}	V _{EN} = V _{IN1} = V _{IN2}	0.8	—	—	V	
Standby current	I _{IN (STBY) 1}	V _{IN1} = V _{IN2} = 5V, V _{EN} = 0V V _{FB} = 0.8V	—	—	10	μA	
	I _{IN (STBY) 2}	V _{IN1} = V _{IN2} = 3.3 V, V _{EN} = 0 V V _{FB} = 0.8V	—	—	10		
High-side switch leakage current	I _{LEAK (H)}	V _{IN1} = V _{IN2} = 5V, V _{EN} = 0V V _{FB} = 0.8V, V _{LX} = 0V	—	—	10	μA	
EN threshold voltage	V _{IH (EN) 1}	V _{IN1} = V _{IN2} = 5V	1.5	—	—	V	
	V _{IH (EN) 2}	V _{IN1} = V _{IN2} = 3.3V	1.5	—	—		
	V _{IL (EN) 1}	V _{IN1} = V _{IN2} = 5V	—	—	0.5		
	V _{IL (EN) 2}	V _{IN1} = V _{IN2} = 3.3V	—	—	0.5		
EN input current	I _{IH (EN) 1}	V _{IN1} = V _{IN2} = 5V, V _{EN} = 5V	6	—	13	μA	
	I _{IH (EN) 2}	V _{IN1} = V _{IN2} = 3.3V, V _{EN} = 3.3V	4	—	9		
V _{FB} input voltage	V _{FB1}	V _{IN1} = V _{IN2} = 5V, V _{EN} = 5V T _j = 0 to 85°C	0.792	0.8	0.808	V	
	V _{FB2}	V _{IN1} = V _{IN2} = 3.3V, V _{EN} = 3.3V T _j = 0 to 85°C	0.792	0.8	0.808		
V _{FB} input current	I _{FB}	V _{IN1} = V _{IN2} = 2.7V to 5.6V V _{FB} = V _{IN2}	-1	—	1	μA	
High-side switch on-state resistance	R _{D(S) (ON) (H) 1}	V _{IN1} = V _{IN2} = 5V, V _{EN} = 5V I _{LX} = -1.5 A	—	0.08	—	Ω	
	R _{D(S) (ON) (H) 2}	V _{IN1} = V _{IN2} = 3.3V, V _{EN} = 3.3V I _{LX} = -1.5 A	—	0.1	—		
On-state resistance of high-side transistor connected to the LSG pin	R _{LSG (ON) (H)}	V _{IN1} = V _{IN2} = 5V	—	0.9	—	Ω	
On-state resistance of low-side transistor connected to the LSG pin	R _{LSG (ON) (L)}	V _{IN1} = V _{IN2} = 5V	—	0.6	—		
Oscillation frequency	f _{OSC}	V _{IN1} = V _{IN2} = V _{EN} = 5V	800	1000	1200	kHz	
Internal soft-start time	t _{SS}	V _{IN1} = V _{IN2} = 5V, I _{OUT} = 0A, Measured between 0% and 90% points at V _{OUT} .	0.5	1	1.5	ms	
External soft-start charge current	I _{SS}	V _{IN1} = V _{IN2} = 5V, V _{EN} = 5V	-5	-8	-11	μA	
High-side switch duty cycle	D _{max}	V _{IN1} = V _{IN2} = 2.7V to 5.6 V	—	—	100	%	
Thermal shutdown (TSD)	Detection temperature	T _{SD}	V _{IN1} = V _{IN2} = 5V	—	150	—	°C
	Hysteresis	ΔT _{SD}	V _{IN1} = V _{IN2} = 5V	—	15	—	
Undervoltage lockout (UVLO)	Detection voltage	V _{UV}	V _{EN} = V _{IN1} = V _{IN2}	2.35	2.45	2.6	V
	Recovery voltage	V _{UVR}	V _{EN} = V _{IN1} = V _{IN2}	2.45	2.55	2.7	
	Hysteresis	ΔV _{UV}	V _{EN} = V _{IN1} = V _{IN2}	—	0.1	—	
L _X current limit	I _{LIM1}	V _{IN1} = V _{IN2} = 5V, V _{OUT} = 2V	7.3	8.5	—	A	
	I _{LIM2}	V _{IN1} = V _{IN2} = 3.3V, V _{OUT} = 2V	6.8	8.0	—		
OCP latch detection voltage	V _{LOC}	V _{IN1} = V _{IN2} = 5V	—	0.3	—	V	
OCP latch detection time	t _{LOC}	V _{IN1} = V _{IN2} = 5V, V _{FB} = 0.2V	—	2	—	ms	

Note on Electrical Characteristics

The test condition $T_j = 25^\circ\text{C}$ means a state where any drifts in electrical characteristics incurred by an increase in the chip's junction temperature can be ignored during pulse testing.

Application Circuit Examples

Figure 1 shows a typical application circuit using a low-ESR electrolytic or ceramic capacitor for C_{OUT} .

When Using the TCV7103AF with an External Low-Side MOSFET:

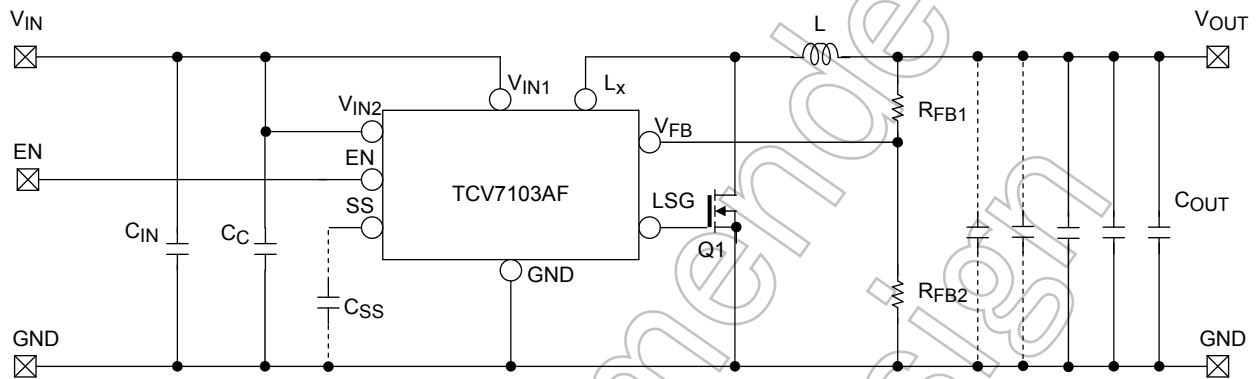

When Using the TCV7103AF with an External Schottky Barrier Diode:

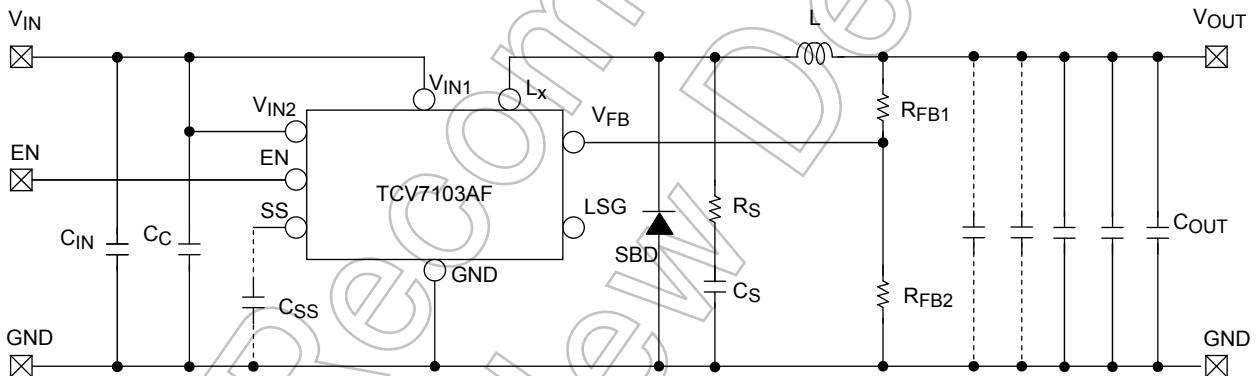

Figure 1 TCV7103AF Typical Application Circuit Examples

Component values (reference value@ $V_{IN} = 5\text{V}$, $V_{OUT} = 3.3\text{V}$, $T_a = 25^\circ\text{C}$)

Q1: Low-side FET (N-channel MOSFET: SSM6K411TU manufactured by Toshiba Corporation)

SBD: Low-side Schottky barrier diode (Schottky barrier diode: CLS01 manufactured by Toshiba Corporation)

C_{IN} : Input filter capacitor = $10\mu\text{F}$

(ceramic capacitor: GRM21BB30J106K manufactured by Murata Manufacturing Co., Ltd.)

C_{OUT} : Output filter capacitor = $10\mu\text{F}$

(ceramic capacitor: GRM21BB30J106K manufactured by Murata Manufacturing Co., Ltd.)

C_C : Decoupling capacitor = $1\mu\text{F}$

(ceramic capacitor: GRM155B30J105K manufactured by Murata Manufacturing Co., Ltd.)

R_{FB1} : Output voltage setting resistor = $7.5\text{k}\Omega$

R_{FB2} : Output voltage setting resistor = $2.4\text{k}\Omega$

R_S : Snubber resistor = 4.7Ω

C_S : Snubber capacitor = 220pF

(ceramic capacitor: GRM1552C1H221J manufactured by Murata Manufacturing Co., Ltd.)

L: Inductor = $1\mu\text{H}$

(VLM10555T-1R2M100-3 or CLF7045T-1R0N manufactured by TDK-EPC Corporation,

DS85LCB B1135AS-1R0N or DG8040C 1267AY-1R0N manufactured by TOKO, INC)

C_{SS} is a capacitor for adjusting the soft-start time.

Examples of Component Values (For Reference Only)

Output Voltage Setting V _{OUT}	Inductance L	Input Capacitance C _{IN}	Output Capacitance C _{OUT}	Feedback Resistor R _{FB1}	Feedback Resistor R _{FB2}
1.0 V	1 μH	10 μF	50 μF	7.5 kΩ	30 kΩ
1.2 V	1 μH	10 μF	30 μF	7.5 kΩ	15 kΩ
1.51 V	1 μH	10 μF	30 μF	16 kΩ	18 kΩ
1.8 V	1 μH	10 μF	30 μF	15 kΩ	12 kΩ
2.5 V	1 μH	10 μF	30 μF	5.1 kΩ	2.4 kΩ
3.3 V	1 μH	10 μF	30 μF	7.5 kΩ	2.4 kΩ

Component values need to be adjusted, depending on the TCV7103AF's I/O conditions and the board layout.

Application Notes

Inductor Selection

The inductance required for inductor L can be calculated as follows:

$$L = \frac{V_{IN} - V_{OUT}}{f_{osc} \cdot \Delta I_L} \cdot \frac{V_{OUT}}{V_{IN}} \dots\dots\dots(1)$$

V_{IN}: Input voltage (V)
 V_{OUT}: Output voltage (V)
 f_{OSC}: Oscillation frequency = 1000kHz (typ.)
 ΔI_L: Inductor ripple current (A)

*: Generally, ΔI_L should be set to approximately 20% of the maximum output current. Since the maximum output current of the TCV7103AF is 6.5A, ΔI_L should be 1.3A or so. The inductor should have a current rating greater than the peak output current of 7.2A. If the inductor current rating is exceeded, the inductor becomes saturated, leading to an unstable DC-DC converter operation.

When V_{IN} = 5V and V_{OUT} = 3.3V, the required inductance can be calculated as follows. Be sure to select an appropriate inductor, taking the input voltage range into account.

$$L = \frac{V_{IN} - V_{OUT}}{f_{osc} \cdot \Delta I_L} \cdot \frac{V_{OUT}}{V_{IN}}$$

$$= \frac{5 \text{ V} - 3.3 \text{ V}}{1000\text{kHz} \cdot 1.3\text{A}} \cdot \frac{3.3 \text{ V}}{5 \text{ V}}$$

$$= 0.86\mu\text{H} \dots\dots\dots(2)$$

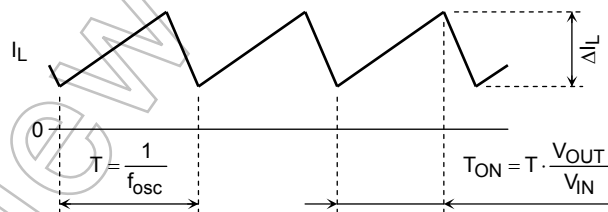

Figure 2 Inductor Current Waveform

Setting the Output Voltage

A resistive voltage divider is connected as shown in Figure 3 to set the output voltage: it is given by Equation 3 based on the reference voltage of the error amplifier (0.8V typ.), which is connected to the Feedback pin, V_{FB}. R_{FB1} should be up to 30kΩ or so, because an extremely large-value R_{FB1} incurs a delay due to parasitic capacitance at the V_{FB} pin. It is recommended that resistors with a precision of ±1% or higher be used for R_{FB1} and R_{FB2}.

$$V_{OUT} = V_{FB} \cdot \left(1 + \frac{R_{FB1}}{R_{FB2}} \right)$$

$$= 0.8 \text{ V} \cdot \left(1 + \frac{R_{FB1}}{R_{FB2}} \right) \dots\dots\dots(3)$$

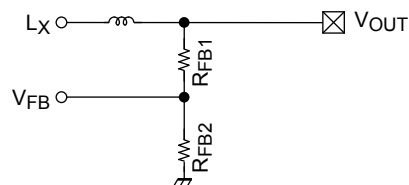

Figure 3 Output Voltage Setting Resistors

Output Filter Capacitor Selection

Use a low-ESR electrolytic or ceramic capacitor as the output filter capacitor. Since a capacitor is generally sensitive to temperature, choose one with excellent temperature characteristics. As a rule of thumb, its capacitance should be 30 μ F or greater for applications. The capacitance should be set to an optimal value that meets the system's ripple voltage requirement and transient load response characteristics. The phase margin tends to decrease as the output voltage is getting low. Enlarge a capacitance for output flatness when phase margin is insufficient, or the transient load response characteristics cannot be satisfied. Since the ceramic capacitor has a very low ESR value, it helps reduce the output ripple voltage; however, because the ceramic capacitor provides less phase margin, it should be thoroughly evaluated.

Rectifier Selection

A low-side switch or Schottky barrier diode should be externally connected to the TCV7103AF.

It is recommended that an N-channel MOSFET SSM6K411TU or equivalent be on as a low-side switch. An N-channel MOSFET of a different type can also be used. However, if the switching speed of the external MOSFET is low, a shoot-through current may flow due to the simultaneous conduction of high-side and low-side switches, leading to device failure. Thus, observe the waveform at the LX pin while operating the TCV7103AF with a current close to the rated value to make sure that there is a dead time (the period between the time when the low-side switch is turned off and the high-side switch is turned on) of more than 10ns. Thorough evaluation is required to ensure that the TCV7103AF provides an appropriate dead time even when in the end-product environment.

As for the Schottky barrier diode, the CLS01 is recommended to be used. Using a Schottky barrier diode tends to lead to a large voltage overshoot on the LX pin. Thus, a series RC filter consisting of a resistor of $R_S = 4.7\Omega$ and a capacitor of $C_S = 220\text{pF}$ should be connected in parallel with the Schottky barrier diode. Power loss of a Schottky barrier diode tends to increase due to an increased reverse current caused by the rise in ambient temperature and self-heating due to a supplied current. The rated current should therefore be derated to allow for such conditions in selecting an appropriate diode.

Soft-Start Feature

The TCV7103AF has a soft-start feature.

If the SS pin is left open, the soft-start time, t_{SS} , for VOUT defaults to 1ms (typ.) internally.

The soft-start time can be extended by adding an external capacitor (C_{SS}) between the SS and GND pins. The soft-start time can be calculated as follows:

$$t_{SS2} = 0.1 \cdot C_{SS} \quad (4)$$

t_{SS2} : Soft-start time (in seconds) when an external capacitor is connected between SS and GND.

C_{SS} : Capacitor value (μF)

The soft-start feature is activated when the TCV7103AF exits the undervoltage lockout (UVLO) state after power-up and when the voltage at the EN pin has changed from logic low to logic high.

Overcurrent Protection (OCP)

TCV7103AF has an overcurrent protection with latch function. When a peak current of Lx pin exceeds a $I_{LIM} = 8.5A$ (typ.)@ $V_{IN} = 5V$, ON time of high-side switch (internal) is limited. When OCP is in operation, and V_{FB} input voltage drops below latch detection voltage $V_{LOC} = 0.3V$ (typ.) for more than latch detection time $t_{LOC} = 2ms$ (typ.), TCV7103AF will halt the output voltage and this state is latched. When the EN pin level changes from high to low, or the input voltage becomes under $V_{UV} = 2.45V$ (typ.), releases the latch. While soft-start feature is in operation, OCP does not operate. In the condition with low input voltage, the current limitation value tends to decrease. In the condition of less than $V_{IN} = 3.8V$, please use it below output current $I_{OUT} = 6.0A$ (max).

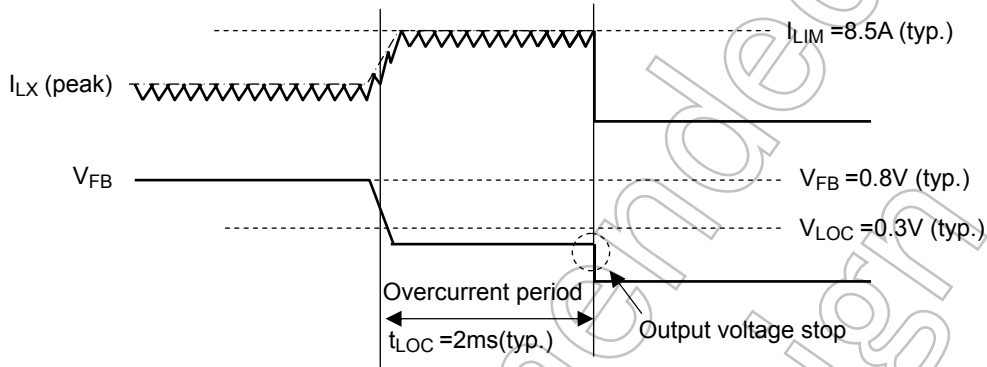

Figure 4 Overcurrent Protection Operation

Undervoltage Lockout (UVLO)

The TCV7103AF has undervoltage lockout (UVLO) protection circuitry. The TCV7103AF does not provide output voltage (V_{OUT}) until the input voltage (V_{IN2}) has reached $V_{UVR} = 2.55V$ (typ.). UVLO has hysteresis of $0.1V$ (typ.). After the switch turns on, if V_{IN2} drops below $V_{UV} = 2.45V$ (typ.), UVLO shuts off the switch at V_{OUT} .

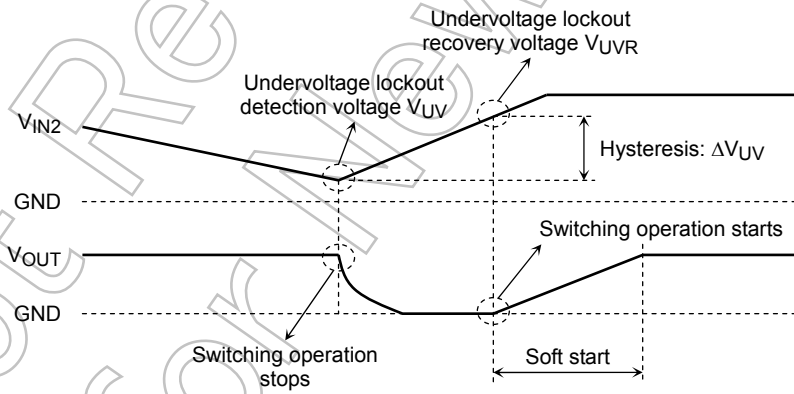

Figure 5 Undervoltage Lockout Operation

Thermal Shutdown (TSD)

The TCV7103AF provides thermal shutdown. When the junction temperature continues to rise and reaches $TSD = 150^{\circ}\text{C}$ (typ.), the TCV7103AF goes into thermal shutdown and shuts off the power supply. TSD has a hysteresis of about 15°C (typ.). The device is enabled again when the junction temperature has dropped by approximately 15°C from the TSD trip point. The device resumes the power supply when the soft-start circuit is activated upon recovery from TSD state.

Thermal shutdown is intended to protect the device against abnormal system conditions. It should be ensured that the TSD circuit will not be activated during normal operation of the system.

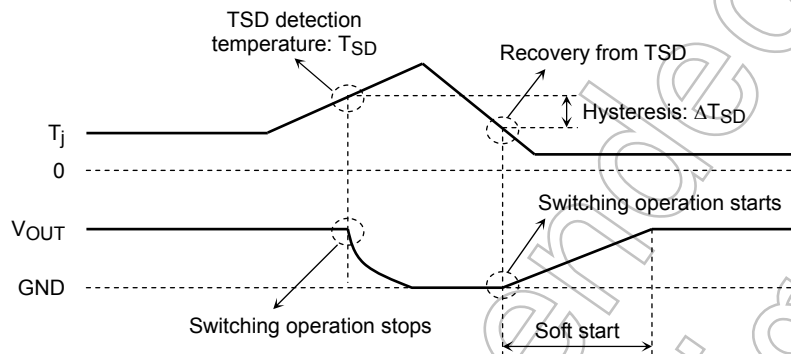
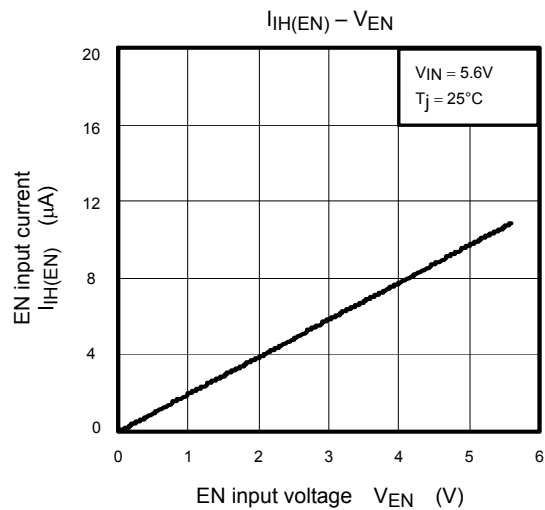
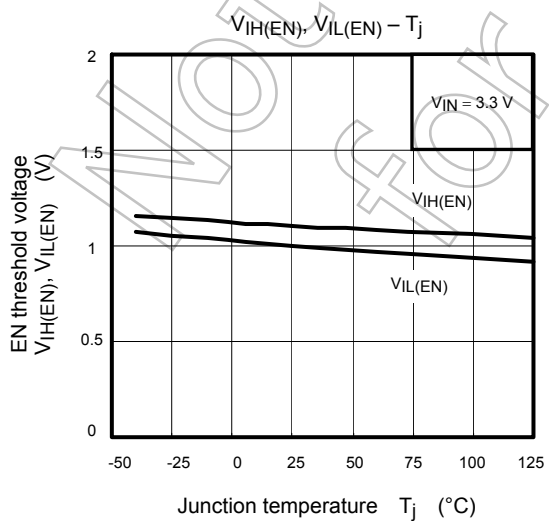
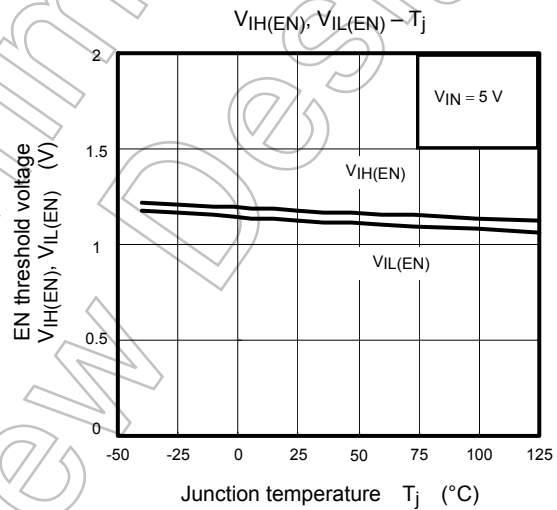
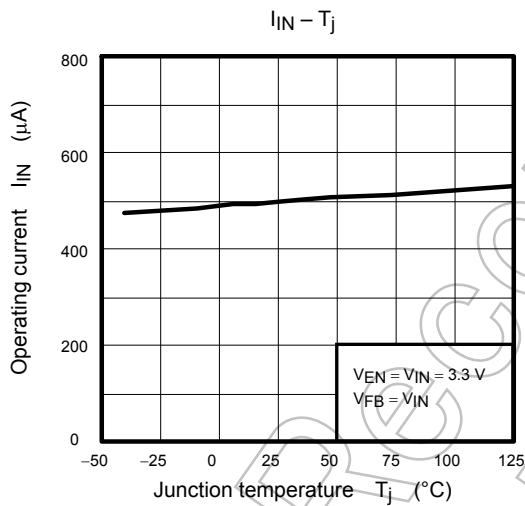
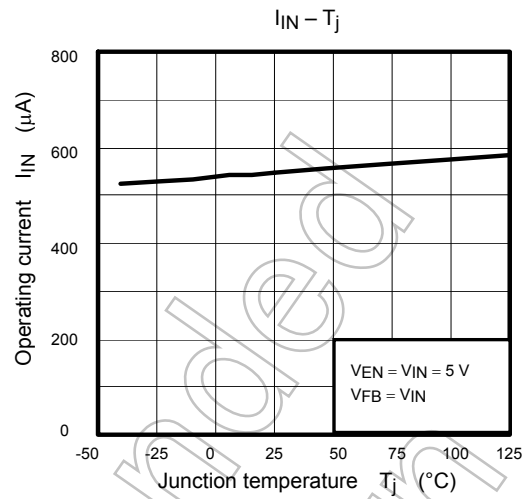
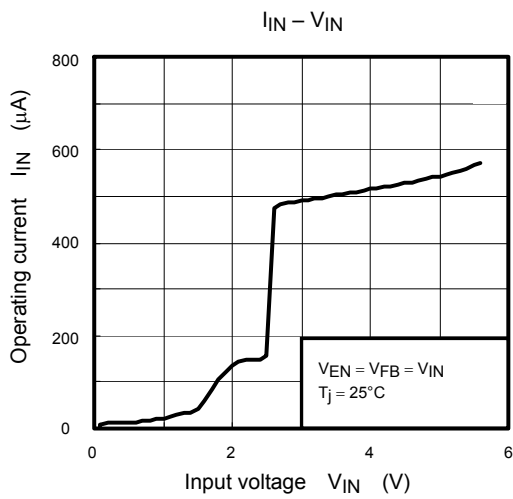

Figure 6 Thermal Shutdown Operation

Usage Precautions

- The input voltage, output voltage, output current and temperature conditions should be considered when selecting capacitors, inductors and resistors. These components should be evaluated on an actual system prototype for best selection.
- Parts of this product in the surrounding are examples of the representative, and the supply might become impossible. Please confirm latest information when using it.
- External components such as capacitors, inductors and resistors should be placed as close to the TCV7103AF as possible.
- The TCV7103AF has an ESD diode between the EN and V_{IN2} pins. The voltage between these pins should satisfy $V_{EN} - V_{IN2} < 0.3\text{V}$.
- Add a decoupling capacitor (CC) of $0.1\mu\text{F}$ to $1\mu\text{F}$ between the GND and V_{IN2} pins. To achieve stable operation, also insert a resistor of about $100\ \Omega$ between the V_{IN2} and V_{IN1} pins to reduce the ripple voltage at the V_{IN2} pin.
- The minimum programmable output voltage is 0.8V (typ.). If the difference between the input and output voltages is small, the output voltage might not be regulated accurately and fluctuate significantly.
- GND pin is connected with the back of IC chip and serves as the heat radiation pin. Secure the area of a GND pattern as large as possible for greater of heat radiation.
- The overcurrent protection circuits in the Product are designed to temporarily protect Product from minor overcurrent of brief duration. When the overcurrent protective function in the Product activates, immediately cease application of overcurrent to Product. Improper usage of Product, such as application of current to Product exceeding the absolute maximum ratings, could cause the overcurrent protection circuit not to operate properly and/or damage Product permanently even before the protection circuit starts to operate.
- The thermal shutdown circuits in the Product are designed to temporarily protect Product from minor overheating of brief duration. When the overheating protective function in the Product activates, immediately correct the overheating situation. Improper usage of Product, such as the application of heat to Product exceeding the absolute maximum ratings, could cause the overheating protection circuit not to operate properly and/or damage Product permanently even before the protection circuit starts to operate.

Typical Performance Characteristics



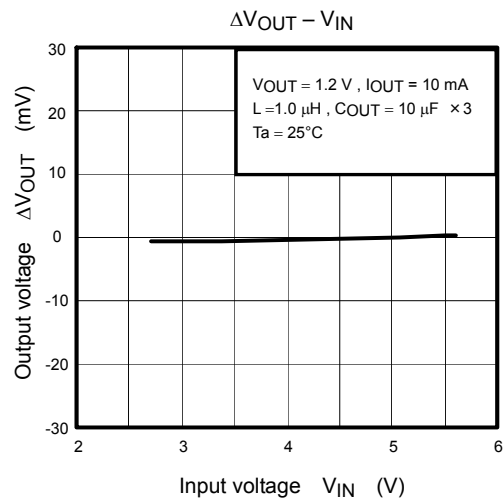
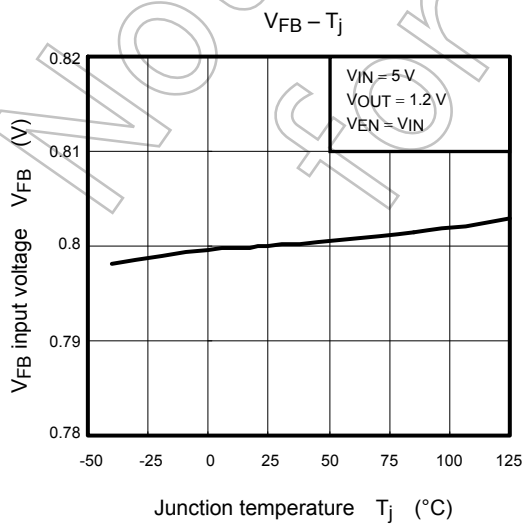
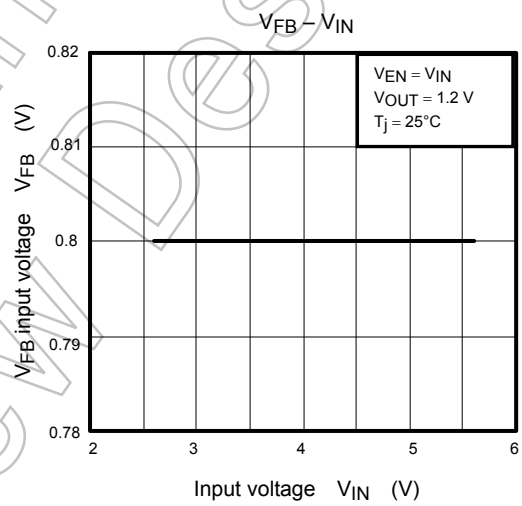
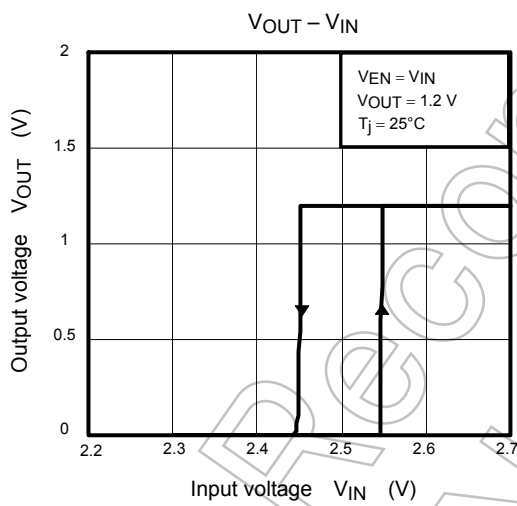
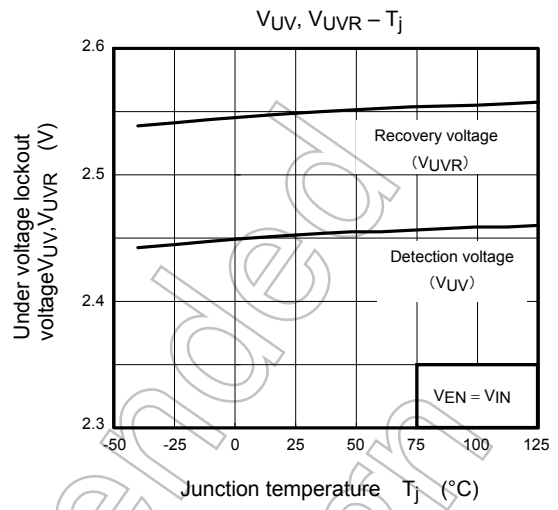
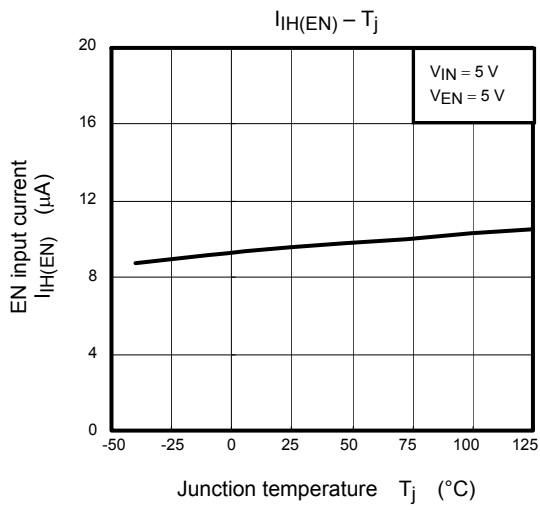

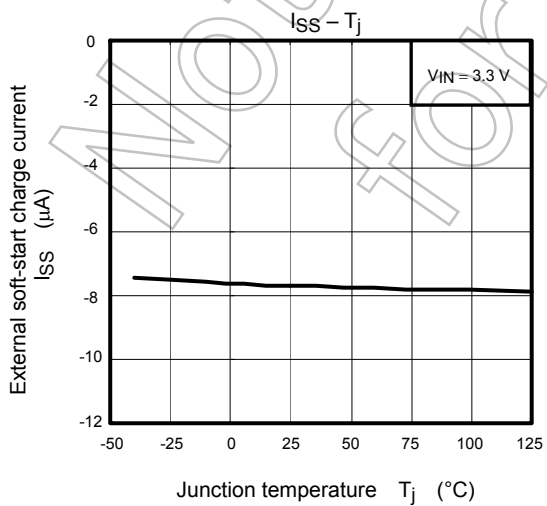
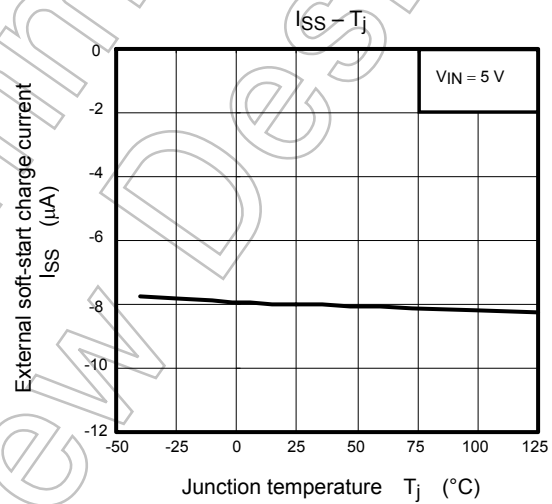
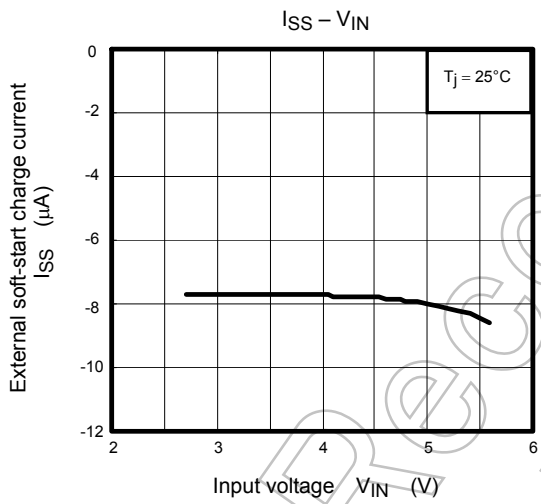
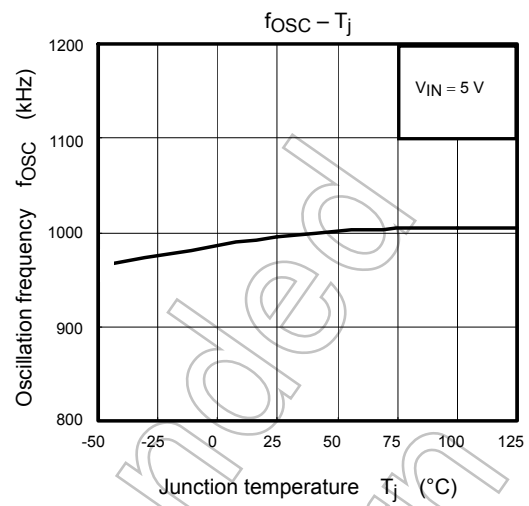
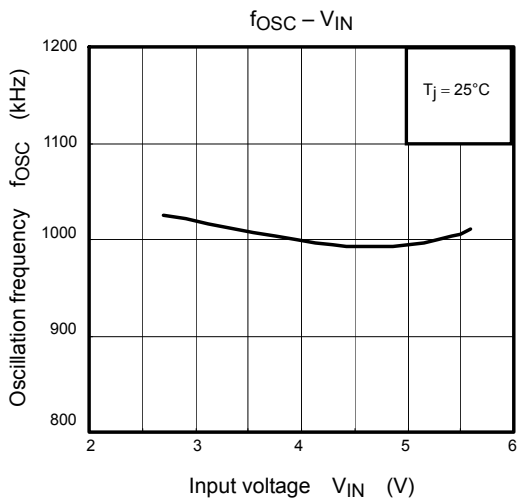

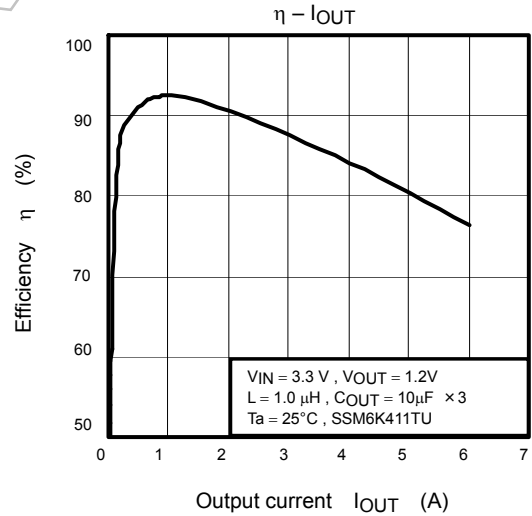
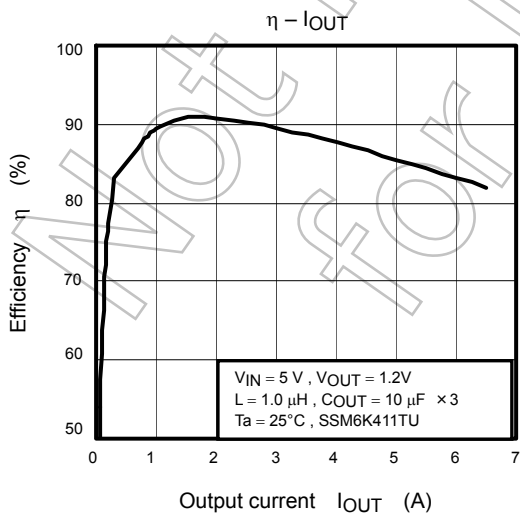
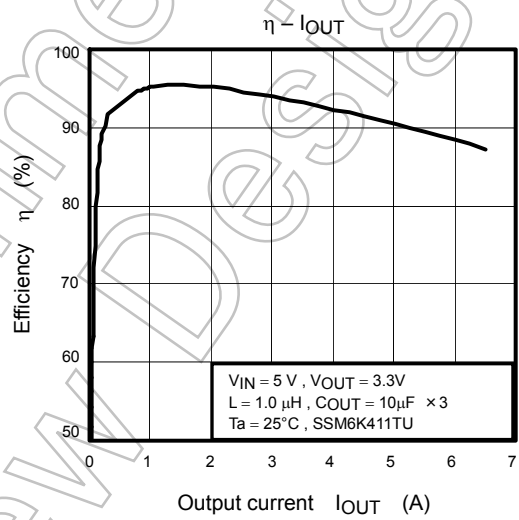
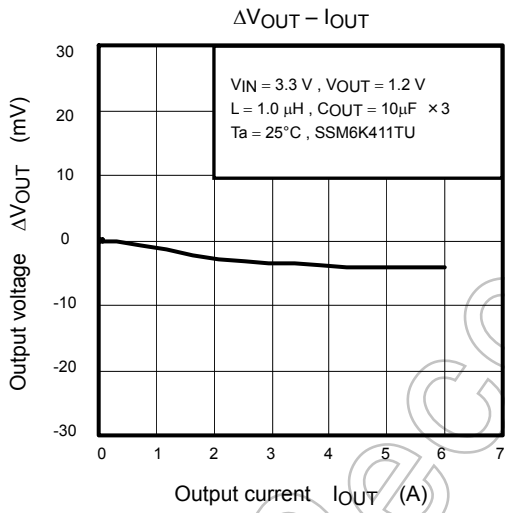
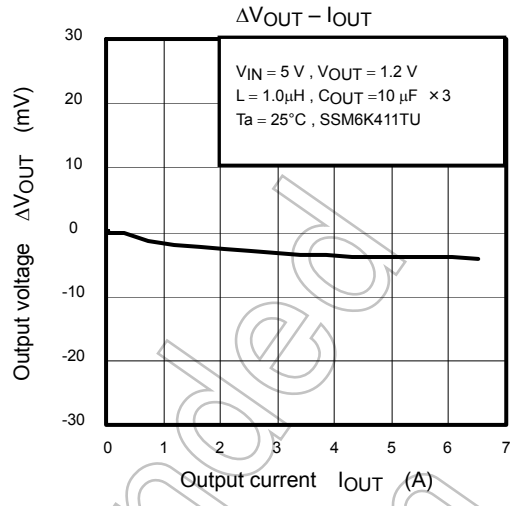
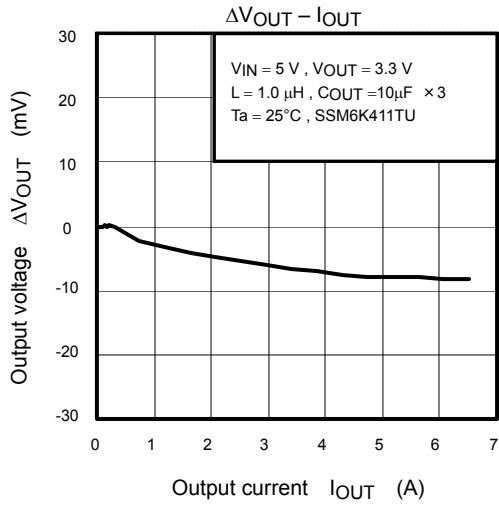

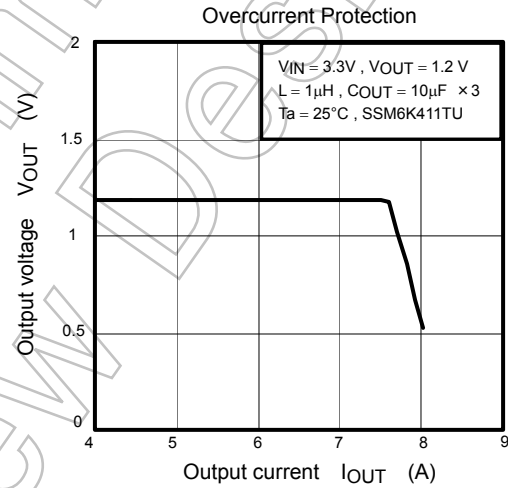
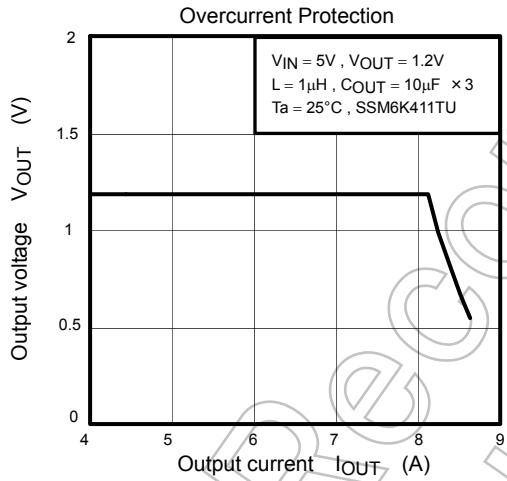
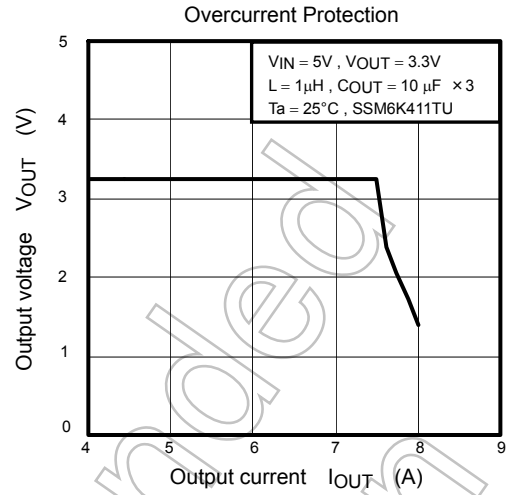
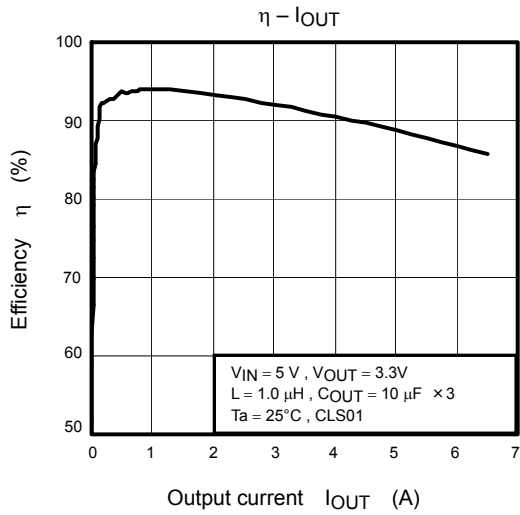

Not for New Products

Startup Characteristics
(Internal Soft-Start Time)

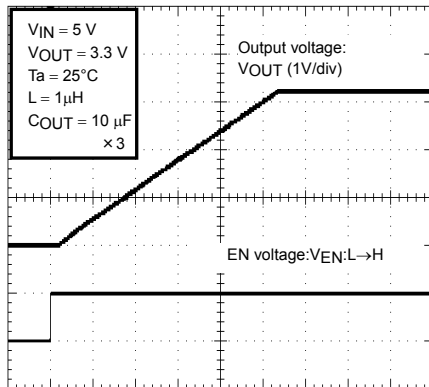

Startup Characteristics
($C_{SS} = 0.1\ \mu\text{F}$)

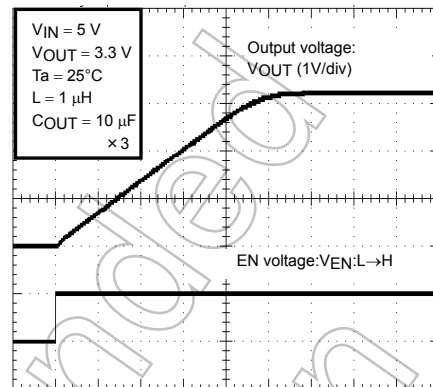

Load Response Characteristics

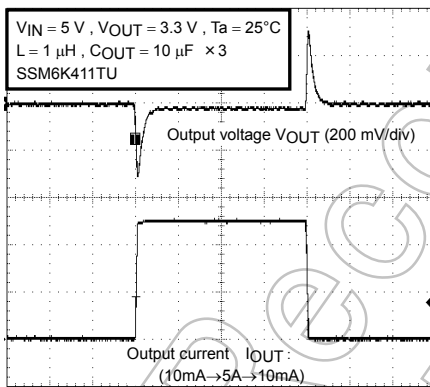

Load Response Characteristics

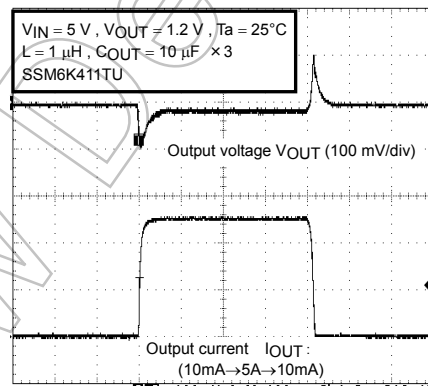

Not for New Commercial Design

Package Dimensions

HSON8-P-0505-1.27

Unit: mm

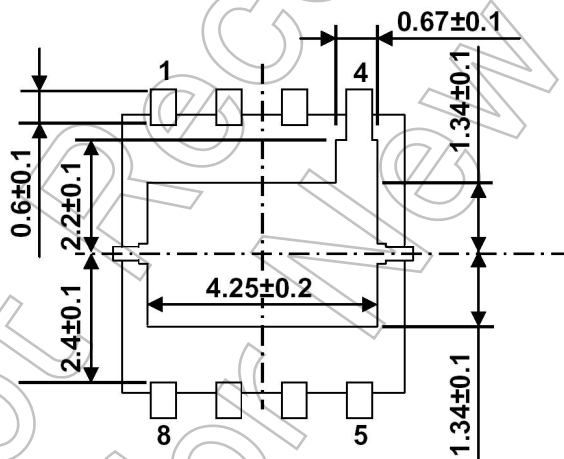
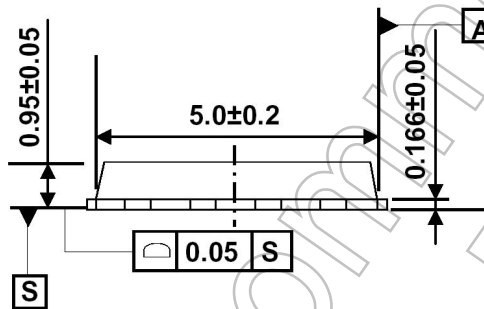
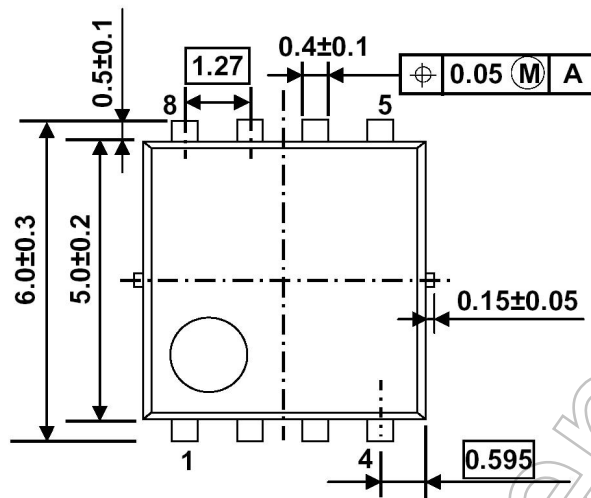

Weight: 0.068 g (typ.)

RESTRICTIONS ON PRODUCT USE

- Toshiba Corporation, and its subsidiaries and affiliates (collectively "TOSHIBA"), reserve the right to make changes to the information in this document, and related hardware, software and systems (collectively "Product") without notice.
- This document and any information herein may not be reproduced without prior written permission from TOSHIBA. Even with TOSHIBA's written permission, reproduction is permissible only if reproduction is without alteration/omission.
- Though TOSHIBA works continually to improve Product's quality and reliability, Product can malfunction or fail. Customers are responsible for complying with safety standards and for providing adequate designs and safeguards for their hardware, software and systems which minimize risk and avoid situations in which a malfunction or failure of Product could cause loss of human life, bodily injury or damage to property, including data loss or corruption. Before customers use the Product, create designs including the Product, or incorporate the Product into their own applications, customers must also refer to and comply with (a) the latest versions of all relevant TOSHIBA information, including without limitation, this document, the specifications, the data sheets and application notes for Product and the precautions and conditions set forth in the "TOSHIBA Semiconductor Reliability Handbook" and (b) the instructions for the application with which the Product will be used with or for. Customers are solely responsible for all aspects of their own product design or applications, including but not limited to (a) determining the appropriateness of the use of this Product in such design or applications; (b) evaluating and determining the applicability of any information contained in this document, or in charts, diagrams, programs, algorithms, sample application circuits, or any other referenced documents; and (c) validating all operating parameters for such designs and applications. **TOSHIBA ASSUMES NO LIABILITY FOR CUSTOMERS' PRODUCT DESIGN OR APPLICATIONS.**
- **PRODUCT IS NEITHER INTENDED NOR WARRANTED FOR USE IN EQUIPMENTS OR SYSTEMS THAT REQUIRE EXTRAORDINARILY HIGH LEVELS OF QUALITY AND/OR RELIABILITY, AND/OR A MALFUNCTION OR FAILURE OF WHICH MAY CAUSE LOSS OF HUMAN LIFE, BODILY INJURY, SERIOUS PROPERTY DAMAGE AND/OR SERIOUS PUBLIC IMPACT ("UNINTENDED USE").** Except for specific applications as expressly stated in this document, Unintended Use includes, without limitation, equipment used in nuclear facilities, equipment used in the aerospace industry, medical equipment, equipment used for automobiles, trains, ships and other transportation, traffic signaling equipment, equipment used to control combustions or explosions, safety devices, elevators and escalators, devices related to electric power, and equipment used in finance-related fields. **IF YOU USE PRODUCT FOR UNINTENDED USE, TOSHIBA ASSUMES NO LIABILITY FOR PRODUCT.** For details, please contact your TOSHIBA sales representative.
- Do not disassemble, analyze, reverse-engineer, alter, modify, translate or copy Product, whether in whole or in part.
- Product shall not be used for or incorporated into any products or systems whose manufacture, use, or sale is prohibited under any applicable laws or regulations.
- The information contained herein is presented only as guidance for Product use. No responsibility is assumed by TOSHIBA for any infringement of patents or any other intellectual property rights of third parties that may result from the use of Product. No license to any intellectual property right is granted by this document, whether express or implied, by estoppel or otherwise.
- **ABSENT A WRITTEN SIGNED AGREEMENT, EXCEPT AS PROVIDED IN THE RELEVANT TERMS AND CONDITIONS OF SALE FOR PRODUCT, AND TO THE MAXIMUM EXTENT ALLOWABLE BY LAW, TOSHIBA (1) ASSUMES NO LIABILITY WHATSOEVER, INCLUDING WITHOUT LIMITATION, INDIRECT, CONSEQUENTIAL, SPECIAL, OR INCIDENTAL DAMAGES OR LOSS, INCLUDING WITHOUT LIMITATION, LOSS OF PROFITS, LOSS OF OPPORTUNITIES, BUSINESS INTERRUPTION AND LOSS OF DATA, AND (2) DISCLAIMS ANY AND ALL EXPRESS OR IMPLIED WARRANTIES AND CONDITIONS RELATED TO SALE, USE OF PRODUCT, OR INFORMATION, INCLUDING WARRANTIES OR CONDITIONS OF MERCHANTABILITY, FITNESS FOR A PARTICULAR PURPOSE, ACCURACY OF INFORMATION, OR NONINFRINGEMENT.**
- Do not use or otherwise make available Product or related software or technology for any military purposes, including without limitation, for the design, development, use, stockpiling or manufacturing of nuclear, chemical, or biological weapons or missile technology products (mass destruction weapons). Product and related software and technology may be controlled under the applicable export laws and regulations including, without limitation, the Japanese Foreign Exchange and Foreign Trade Law and the U.S. Export Administration Regulations. Export and re-export of Product or related software or technology are strictly prohibited except in compliance with all applicable export laws and regulations.
- Please contact your TOSHIBA sales representative for details as to environmental matters such as the RoHS compatibility of Product. Please use Product in compliance with all applicable laws and regulations that regulate the inclusion or use of controlled substances, including without limitation, the EU RoHS Directive. **TOSHIBA ASSUMES NO LIABILITY FOR DAMAGES OR LOSSES OCCURRING AS A RESULT OF NONCOMPLIANCE WITH APPLICABLE LAWS AND REGULATIONS.**