

3A Adjustable Output Voltage LDO Regulator

General Description

The RT9033 is a low dropout linear regulator designed for high output current applications with critical performance. The IC responds very fast to step changes in load, which is suitable for low voltage microprocessor applications.

The RT9033 uses an internal P-MOSFET as the pass device, which does not cause extra GND current in heavy load and dropout condition. The shutdown mode of low operation current makes the IC suitable for power-saving systems.

The RT9033 also works well with low-ESR ceramic capacitors, reducing the amount of board space necessary for power applications and consumes less than 1µA in shutdown mode. The other features include ultra low dropout voltage, high output accuracy, current limiting protection and over temperature protection. The RT9033 is available in the TO-263-5 package.

Ordering Information

RT9033□□

- Package Type
M5 : TO-263-5
- Lead Plating System
G : Green (Halogen Free and Pb Free)

Note :

Richtek products are :

- ▶ RoHS compliant and compatible with the current requirements of IPC/JEDEC J-STD-020.
- ▶ Suitable for use in SnPb or Pb-free soldering processes.

Typical Application Circuit

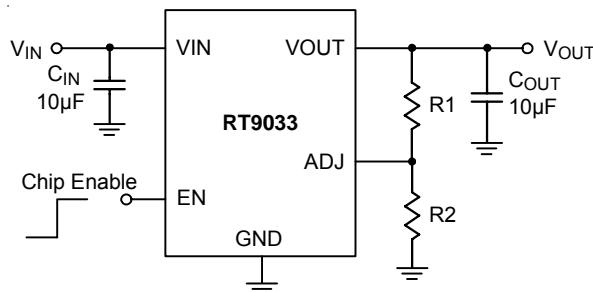

Note : $V_{OUT} = V_{REF} \times (1 + \frac{R1}{R2})$

Features

- High Current Capability : 3A
- Low Dropout : 350mV at 3A
- Low Ground Current : 250µA
- Adjustable Output Voltage
- Extremely Low Output Capacitor Requirement
- Internal Over Current Protection
- Internal Over Temperature Protection
- RoHS Compliant and Halogen Free

Applications

- Battery-Powered Equipment
- High Efficiency "Green" Computer Systems
- Automotive Electronics
- High Efficiency Linear Lower Supplies
- High Efficiency Lost-Regulator for Switching Supply

Pin Configurations

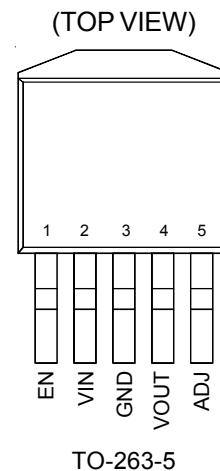

Function Pin Description

Pin No.	Pin Name	Pin Function
1	EN	Enable Input Logic, Active High. When the EN goes to a logic low or floating, the device is in shutdown mode.
2	VIN	Power Supply Input Pin.
3	GND	Ground Pin.
4	VOUT	Regulator Output Pin.
5	ADJ	Adjustable Output Pin

Function Block Diagram

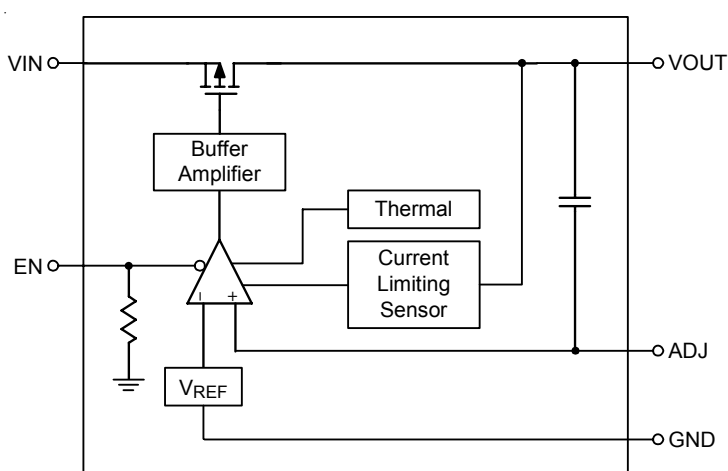

Absolute Maximum Ratings (Note 1)

- Supply Input Voltage, V_{IN} ----- 6V
- EN Input Voltage, EN ----- 6V
- All Other Pins ----- 0.3V to 6V
- Power Dissipation, $P_D @ T_A = 25^\circ\text{C}$
- TO-263-5 ----- 3.448W
- Package Thermal Resistance (Note 2)
- TO-263-5, θ_{JA} ----- 29°C/W
- TO-263-5, θ_{JC} ----- 7°C/W
- Lead Temperature (Soldering, 10 sec.) ----- 260°C
- Junction Temperature ----- 150°C
- Storage Temperature Range ----- -65°C to 150°C
- ESD Susceptibility (Note 3)
- HBM ----- 2kV
- MM ----- 200V

Recommended Operating Conditions (Note 4)

- Supply Input Voltage, V_{IN} ----- 2.5V to 5.5V
- EN Input Voltage ----- 0V to 5.5V
- Junction Temperature Range ----- -40°C to 125°C
- Ambient Temperature Range ----- -40°C to 85°C

Electrical Characteristics

($V_{IN} = 5\text{V}$, $V_{EN} = V_{IN}$, $C_{IN} = C_{OUT} = 10\mu\text{F}$ (Ceramic), $T_A = 25^\circ\text{C}$ unless otherwise specified)

Parameter	Symbol	Test Conditions	Min	Typ	Max	Unit
Input Power						
Quiescent Current	I_Q		--	250	--	μA
Shutdown Current	I_{SHDN}	$V_{EN} = \text{GND}$	--	100	--	nA
Reference Voltage						
Reference Voltage	V_{REF}	$V_{ADJ} = V_{OUT}$	--	1.24	--	V
Reference Voltage Tolerance		$I_{OUT} = 10\text{mA}$	-1	--	1	%
Regulation						
Line Regulation	ΔV_{LINE}	$I_{OUT} = 10\text{mA}$, $(V_{OUT}+1) < V_{IN} < 5\text{V}$	--	0.06	0.5	%
Load Regulation	ΔV_{LOAD}	$10\text{mA} < I_{OUT} < 3\text{A}$, $V_{IN} = 5\text{V}$	--	0.2	1	%
Output						
Output Current Limit	I_{LIM}	$V_{IN} = V_{OUT} + 1$	--	4.5	5.5	A
Dropout Voltage	V_{DROP}	$I_{OUT} = 3\text{A}$	--	350	600	mV
Enable						
EN Threshold	Logic-Low Voltage	V_{IL}	--	--	0.4	V
	Logic-High Voltage	V_{IH}	1.2	--	--	
Enable Pin Current	I_{EN}	$V_{IN} = V_{EN}$	--	--	20	μA

To be continued

Parameter	Symbol	Test Conditions	Min	Typ	Max	Unit
Thermal Protection						
Thermal Shutdown Temperature	T_{SD}		--	165	--	°C
Thermal Shutdown Hysteresis	ΔT_{SD}		--	30	--	

Note 1. Stresses listed as the above “Absolute Maximum Ratings” may cause permanent damage to the device. These are for stress ratings. Functional operation of the device at these or any other conditions beyond those indicated in the operational sections of the specifications is not implied. Exposure to absolute maximum rating conditions for extended periods may remain possibility to affect device reliability.

Note 2. θ_{JA} is measured in the natural convection at $T_A = 25^\circ\text{C}$ on a high effective four layers thermal conductivity test board of JEDEC 51-7 thermal measurement standard. The case point of θ_{JC} is on the exposed pad for the package. The copper area as heat sink is 225mm^2 .

Note 3. Devices are ESD sensitive. Handling precaution is recommended.

Note 4. The device is not guaranteed to function outside its operating conditions.

Typical Operating Characteristics

$C_{IN} = C_{OUT} = 10\mu F/X7R$, $R1 = R2 = 130k\Omega$, unless otherwise specified.

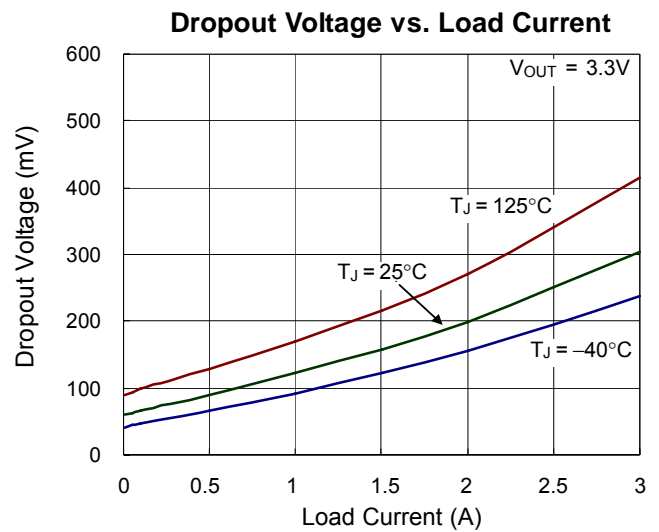
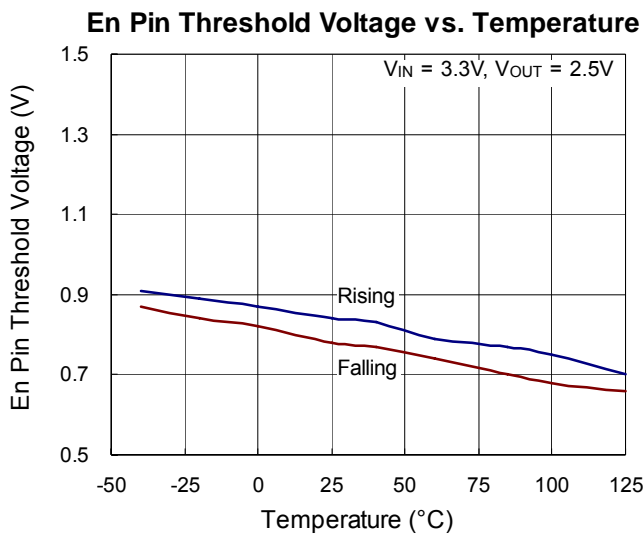
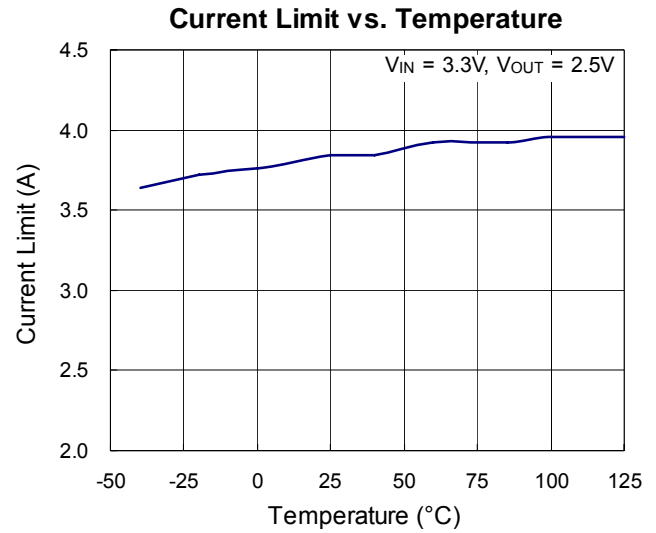
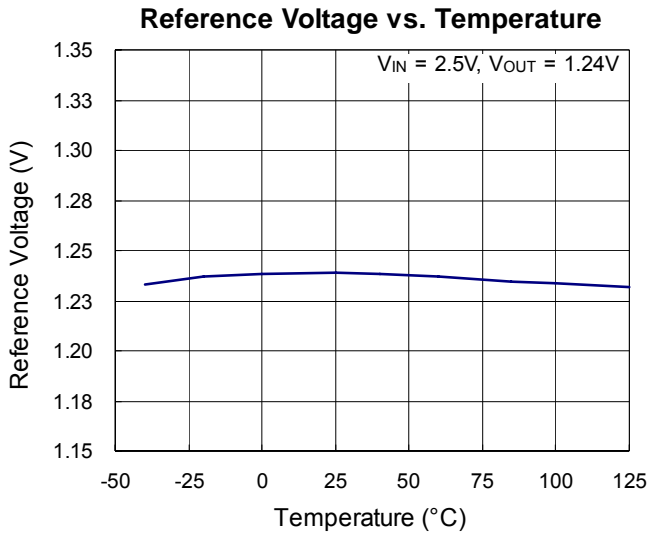
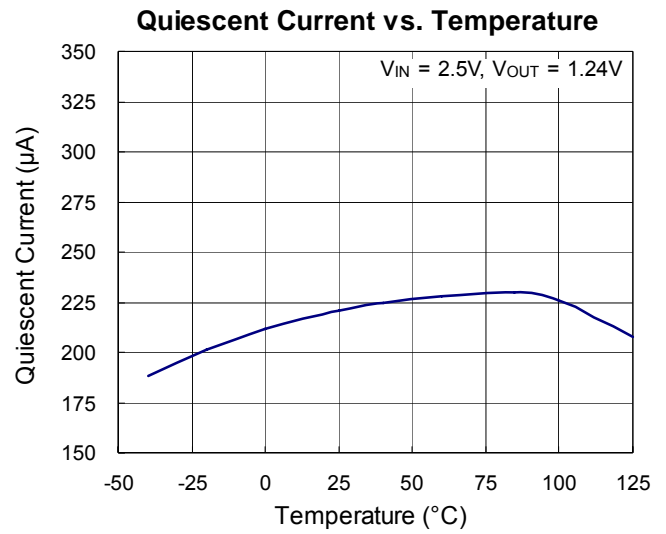
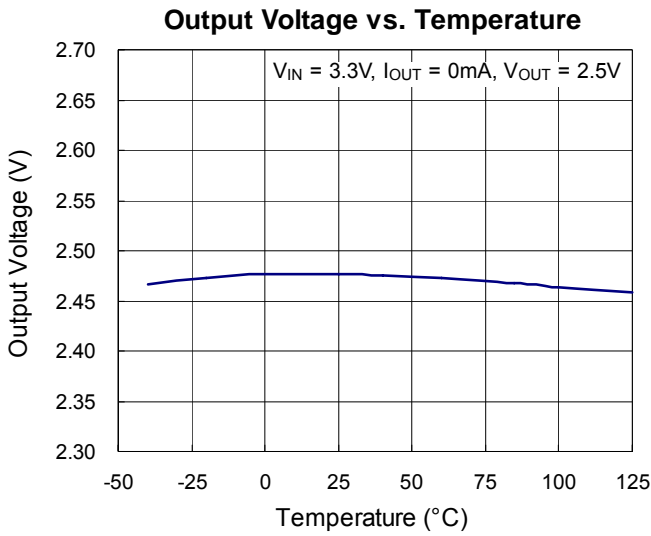

Load Transient Response

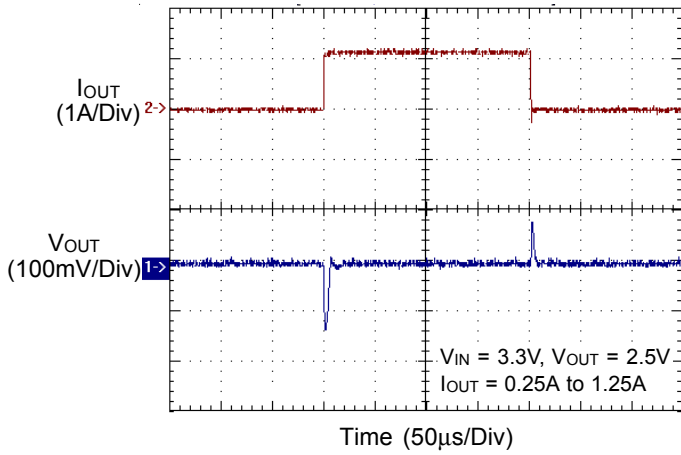

Load Transient Response

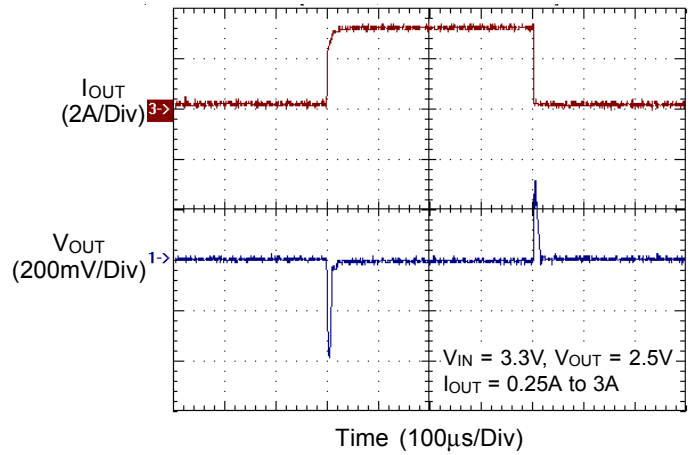

Line Transient Response

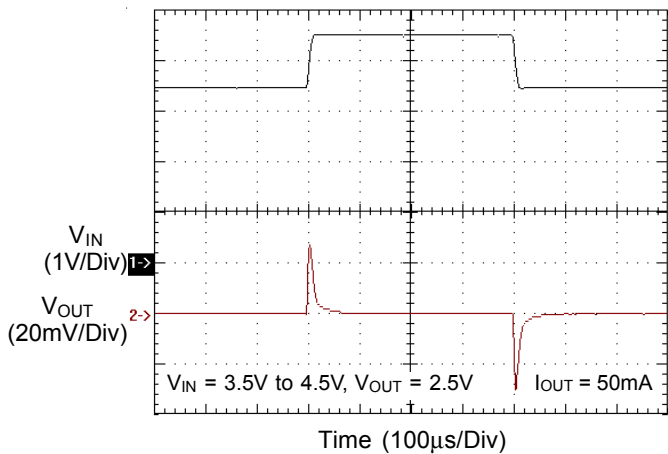

Line Transient Response

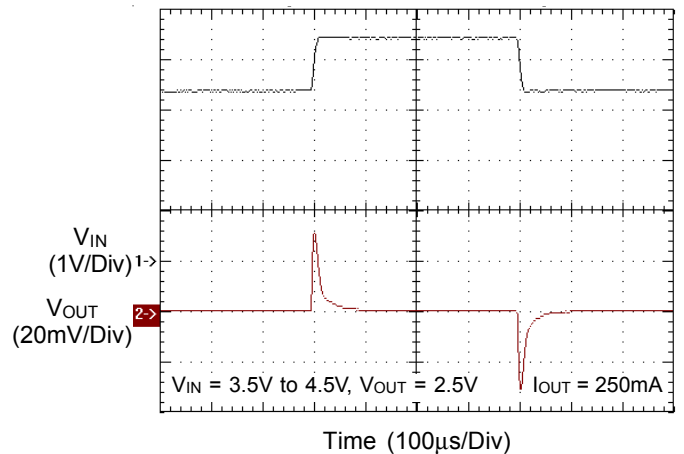

Current Limit

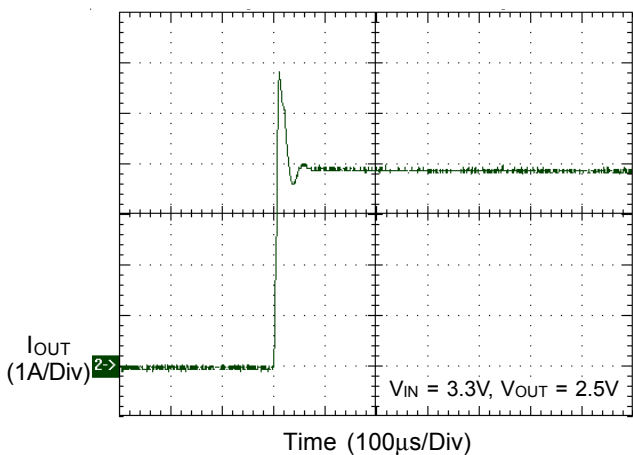

Start Up

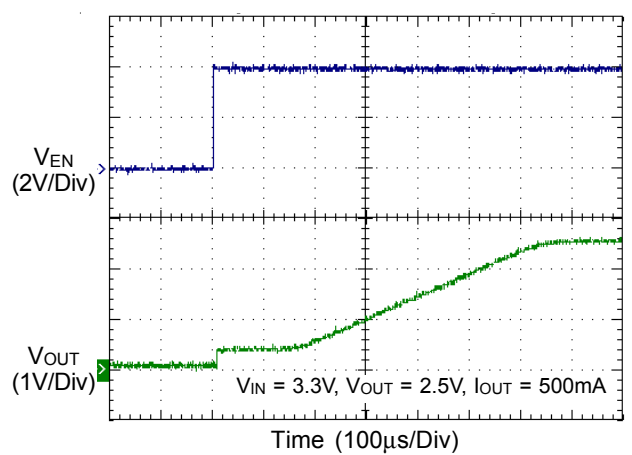

Applications Information

Input and Output Capacitor Selection

Like any low-dropout regulator, the external capacitors used with the RT9033 must be carefully selected for regulator stability and performance. Using a capacitor whose value is > 10μF on the RT9033 input and the amount of capacitance can be increased without limit. The input capacitor must be located at a distance of not more than 0.5 inch from the input pin of the IC and returned to a clean analog ground. Any good quality ceramic can be used for this capacitor. The capacitor with larger value and lower ESR (equivalent series resistance) provides better line-transient response.

The output capacitor must meet both requirements for minimum amount of capacitance and ESR in all LDOs application. The RT9033 is designed specifically to work with low ESR ceramic output capacitor in space-saving and performance consideration. Using a ceramic capacitor whose value is at least 1μF with ESR is > 25mΩ on the RT9033 output ensures stability. The RT9033 still works well with output capacitor of other types due to the wide stable ESR range. Figure 1. shows the curves of allowable ESR range as a function of load current for various output capacitor values. Output capacitor of larger capacitance can reduce noise and improve load transient response, stability, and PSRR. The output capacitor should be located at not more than 0.5 inch from the VOUT pin of the RT9033 and returned to a clean analog ground.

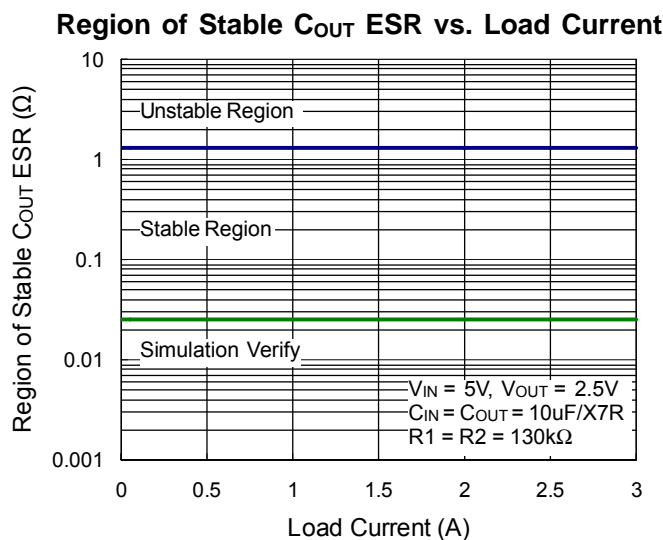

Figure 1

Output Voltage Setting

The RT9033 output voltage can provide 1.24V to 4.9V (dropout voltage maximum 0.6V) operating rating. To use two resistors to adjust the customer's ideal output voltage. Resistors can be large to up to 1MΩ, because of the very high impedance and low bias current of the sense comparator. The resistor values are calculated by :

$$V_{OUT} = V_{REF} \times \left(1 + \frac{R1}{R2} \right)$$

Chip Enable Operation

The RT9033 goes into sleep mode when the Enable pin is in a logic low condition. During this condition, the pass transistor, error amplifier, and band gap are turned off, reducing the supply current to 0.1μA. The Enable pin can be directly tied to VIN to keep the part on.

Current Limit

The RT9033 contains an independent current limiter, which monitors and controls the pass transistor's gate voltage, limiting the output current to 4.5A (typ.).

PSRR

The power supply rejection ratio (PSRR) is defined as the gain from the input to output divided by the gain from the supply to the output. The PSRR is found to be

$$PSRR = 20 \times \text{Log} \left(\frac{\Delta \text{Gain Error}}{\Delta \text{Supply}} \right) (\text{dB})$$

Note that when heavy load measuring, Δsupply will cause Δtemperature. And Δtemperature will cause Δoutput voltage. So the heavy load PSRR measuring is including temperature effect.

Thermal Considerations

For continuous operation, do not exceed absolute maximum operation junction temperature. The maximum power dissipation depends on the thermal resistance of IC package, PCB layout, the rate of surroundings airflow and temperature difference between junction to ambient. The maximum power dissipation can be calculated by following formula :

$$P_{D(MAX)} = (T_{J(MAX)} - T_A) / \theta_{JA}$$

Where $T_{J(MAX)}$ is the maximum operation junction temperature, T_A is the ambient temperature and the θ_{JA} is the junction to ambient thermal resistance.

For recommended operating conditions specification of RT9033, the maximum operating junction temperature is 125°C. The junction to ambient thermal resistance θ_{JA} is layout dependent. As shown in Figure 2, RT9033 TO-263-5 with 15mm x 15mm PCB copper area on the standard JEDEC 51-7 four layers thermal test board thermal resistance θ_{JA} is about 29°C/W. The maximum power dissipation at $T_A = 25^\circ\text{C}$ can be calculated by following formula :

$$P_{D(MAX)} = (125^\circ\text{C} - 25^\circ\text{C}) / (29^\circ\text{C/W}) = 3.448\text{W for TO-263-5 packages}$$

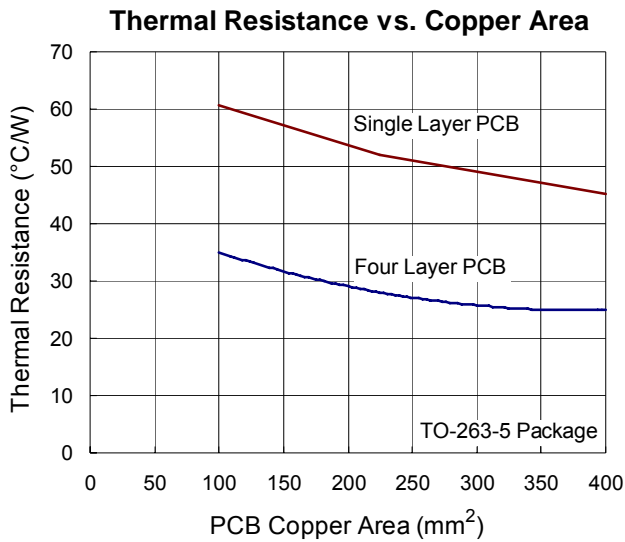

Figure 2. Thermal Resistance θ_{JA} vs. Copper Area of TO-263-5 Packages

The maximum power dissipation depends on operating ambient temperature for fixed $T_{J(MAX)}$ and thermal resistance θ_{JA} . For RT9033 packages, the Figure 3 of de-rating curves allows the designer to see the effect of rising ambient temperature on the maximum power allowed.

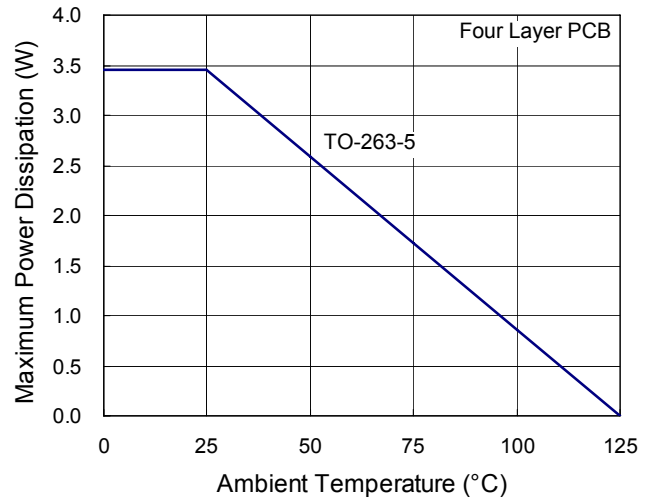
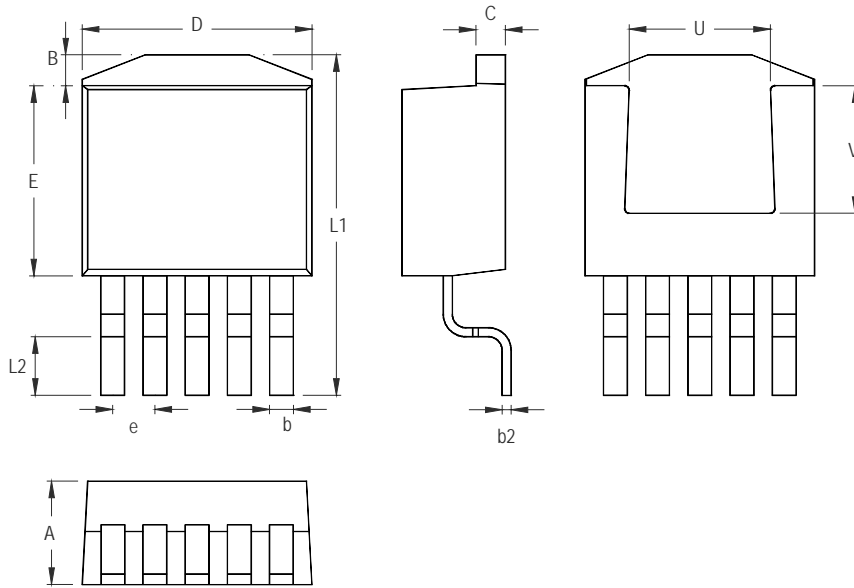

Figure 3. Derating Curves for RT9033 Packages

Outline Dimension



Symbol	Dimensions In Millimeters		Dimensions In Inches	
	Min	Max	Min	Max
A	4.064	4.826	0.160	0.190
B	1.143	1.676	0.045	0.066
b	0.660	0.914	0.026	0.036
b2	0.305	0.584	0.012	0.023
C	1.143	1.397	0.045	0.055
D	9.652	10.668	0.380	0.420
E	8.128	9.652	0.320	0.380
e	1.524	1.829	0.060	0.072
L1	14.605	15.875	0.575	0.625
L2	2.286	2.794	0.090	0.110
U	6.223 Ref.		0.245 Ref.	
V	7.620 Ref.		0.300 Ref.	

5-Lead TO-263 Surface Mount Package

Richtek Technology Corporation

Headquarter
 5F, No. 20, Taiyuen Street, Chupei City
 Hsinchu, Taiwan, R.O.C.
 Tel: (8863)5526789 Fax: (8863)5526611

Richtek Technology Corporation

Taipei Office (Marketing)
 5F, No. 95, Minchiuan Road, Hsintien City
 Taipei County, Taiwan, R.O.C.
 Tel: (8862)86672399 Fax: (8862)86672377
 Email: marketing@richtek.com

Information that is provided by Richtek Technology Corporation is believed to be accurate and reliable. Richtek reserves the right to make any change in circuit design, specification or other related things if necessary without notice at any time. No third party intellectual property infringement of the applications should be guaranteed by users when integrating Richtek products into any application. No legal responsibility for any said applications is assumed by Richtek.