

74F673A 16-Bit Serial-In, Serial/Parallel-Out Shift Register

General Description

The 74F673A contains a 16-bit serial-in, serial-out shift register and a 16-bit Parallel-Out storage register. A single pin serves either as an input for serial entry or as a 3-STATE serial output. In the Serial-Out mode, the data recirculates in the shift register. By means of a separate clock, the contents of the shift register are transferred to the storage register for parallel outputting. The contents of the storage register can also be parallel loaded back into the shift register. A HIGH signal on the Chip Select input prevents both shifting and parallel transfer. The storage register may be cleared via STMR.

Features

- Serial-to-parallel converter
- 16-bit serial I/O shift register
- 16-bit parallel-out storage register
- Recirculating serial shifting
- Recirculating parallel transfer
- Common serial data I/O pin
- Slim 24 lead package

Ordering Code:

Order Number	Package Number	Package Description
74F673ASC	M24B	24-Lead Small Outline Integrated Circuit (SOIC), JEDEC MS-013, 0.300 Wide
74F673APC	N24A	24-Lead Plastic Dual-In-Line Package (PDIP), JEDEC MS-011, 0.600 Wide
74F673ASPC	N24C	24-Lead Plastic Dual-In-Line Package (PDIP), JEDEC MS-001, 0.300 Wide

Devices also available in Tape and Reel. Specify by appending the suffix letter "X" to the ordering code.

Logic Symbols

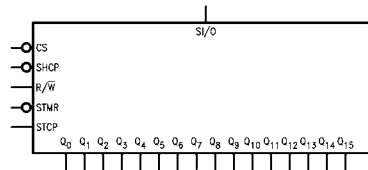
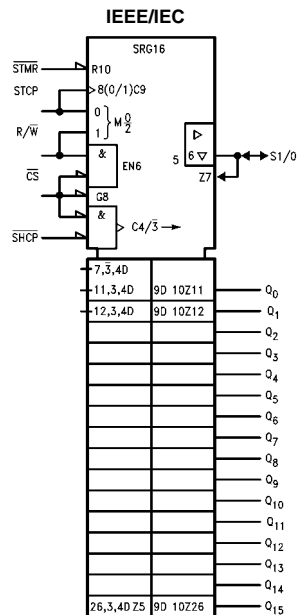

Connection Diagram

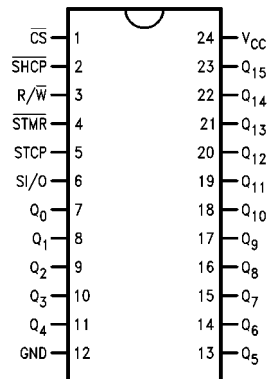

Unit Loading/Fan Out

Pin Names	Description	U.L. HIGH/LOW	Input I_{IH}/I_{IL} Output I_{OH}/I_{OL}
\overline{CS}	Chip Select Input (Active LOW)	1.0/1.0	20 μ A/-0.6 mA
\overline{SHCP}	Shift Clock Pulse Input (Active Falling Edge)	1.0/1.0	20 μ A/-0.6 mA
\overline{STMR}	Store Master Reset Input (Active LOW)	1.0/1.0	20 μ A/-0.6 mA
STCP	Store Clock Pulse Input	1.0/1.0	20 μ A/-0.6 mA
R/ \overline{W}	Read/Write Input	1.0/1.0	20 μ A/-0.6 mA
SI/O	Serial Data Input or 3-STATE Serial Output	3.5/1.0 150/40	70 μ A/-0.6 mA -3 mA/24 mA
Q ₀ -Q ₁₅	Parallel Data Outputs	50/33.3	-1 mA/20 mA

Functional Description

The 16-bit shift register operates in one of four modes, as indicated in the Shift Register Operations Table. A HIGH signal on the Chip Select (\overline{CS}) input prevents clocking and forces the Serial Input/Output (SI/O) 3-STATE buffer into the high impedance state. During serial shift-out operations, the SI/O buffer is active (i.e., enabled) and the output data is also recirculated back into the shift register. When

parallel loading the shift register from the storage register, serial shifting is inhibited.

The storage register has an asynchronous master reset (\overline{STMR}) input that overrides all other inputs and forces the Q₀-Q₁₅ outputs LOW. The storage register is in the Hold mode when either \overline{CS} or the Read/Write (R/ \overline{W}) input is HIGH. With \overline{CS} and R/ \overline{W} both LOW, the storage register is parallel loaded from the shift register.

Shift Register Operations Table

Control Inputs				SI/O Status	Operating Mode
\overline{CS}	R/ \overline{W}	\overline{SHCP}	STCP		
H	X	X	X	High Z	Hold
L	L		X	Data In	Serial Load
L	H	~	L	Data Out	Serial Output with Recirculation
L	H	~	H	Active	Parallel Load; No Shifting

H = HIGH Voltage Level
L = LOW Voltage Level
X = Immaterial
~ = HIGH-to-LOW Transition

Storage Register Operations Table

Control Inputs				Operating Mode
\overline{STMR}	\overline{CS}	R/ \overline{W}	STCP	
L	X	X	X	Reset; Outputs LOW
H	H	X	X	Hold
H	X	H	X	Hold
H	L	L	~	Parallel Load

H = HIGH Voltage Level
L = LOW Voltage Level
X = Immaterial
~ = LOW-to-HIGH Transition

Block Diagram

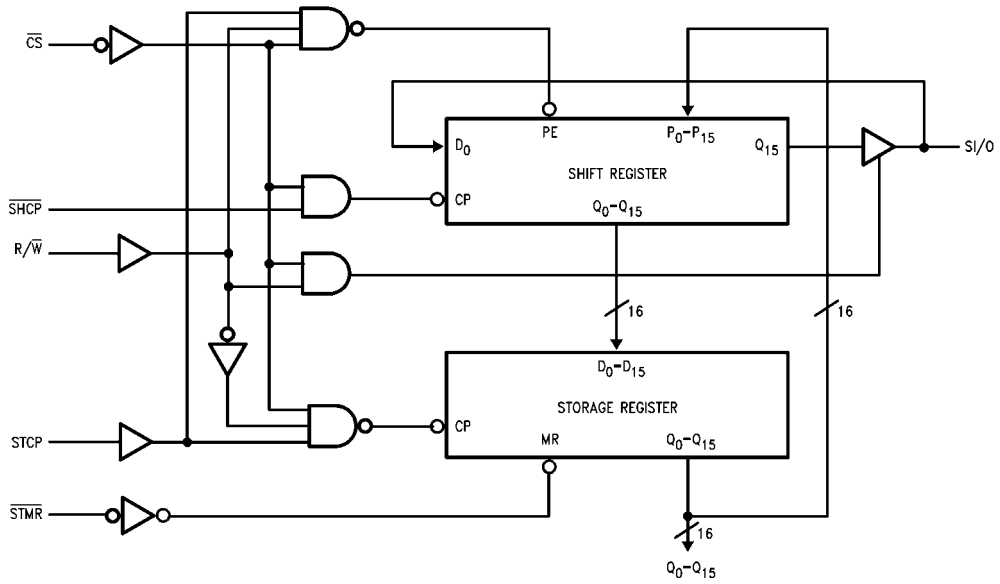

Absolute Maximum Ratings (Note 1)

Storage Temperature	-65°C to +150°C
Ambient Temperature under Bias	-55°C to +125°C
Junction Temperature under Bias	-55°C to +150°C
V _{CC} Pin Potential to Ground Pin	-0.5V to +7.0V
Input Voltage (Note 2)	-0.5V to +7.0V
Input Current (Note 2)	-30 mA to +5.0 mA
Voltage Applied to Output in HIGH State (with V _{CC} = 0V)	
Standard Output	-0.5V to V _{CC}
3-STATE Output	-0.5V to +5.5V
Current Applied to Output in LOW State (Max)	twice the rated I _{OL} (mA)

Recommended Operating Conditions

Free Air Ambient Temperature	0°C to +70°C
Supply Voltage	+4.5V to +5.5V

Note 1: Absolute maximum ratings are values beyond which the device may be damaged or have its useful life impaired. Functional operation under these conditions is not implied.

Note 2: Either voltage limit or current limit is sufficient to protect inputs.

DC Electrical Characteristics

Symbol	Parameter	Min	Typ	Max	Units	V _{CC}	Conditions
V _{IH}	Input HIGH Voltage	2.0			V		Recognized as a HIGH Signal
V _{IL}	Input LOW Voltage			0.8	V		Recognized as a LOW Signal
V _{CD}	Input Clamp Diode Voltage			-1.2	V	Min	I _{IN} = -18 mA (Non I/O pins)
V _{OH}	Output HIGH Voltage	10% V _{CC} 10% V _{CC} 5% V _{CC} 5% V _{CC}	2.5 2.4 2.7 2.7		V	Min	I _{OH} = -1 mA (Q _n , SI/O) I _{OH} = -3 mA (SI/O) I _{OH} = -1 mA (Q _n , SI/O) I _{OH} = -3 mA (SI/O)
V _{OL}	Output LOW Voltage	10% V _{CC} 10% V _{CC}		0.5 0.5	V	Min	I _{OL} = 20 mA (Q _n) I _{OL} = 24 mA (SI/O)
I _{IH}	Input HIGH Current			20	μA	Max	V _{IN} = 2.7V (Non I/O pins)
I _{BVI}	Input HIGH Current Breakdown Test			100	μA	Max	V _{IN} = 7.0V (Non I/O pins)
I _{BVIT}	Input HIGH Current Breakdown Test (I/O)			1.0	mA	Max	V _{IN} = 5.5V (SI/O)
I _{IL}	Input LOW Current			-0.6	mA	Max	V _{IN} = 0.5V
I _{IH} + I _{OZH}	Output Leakage Current			70	μA	Max	V _{OUT} = 2.7V (SI/O)
I _{IL} + I _{OZL}	Output Leakage Current			-650	μA	Max	V _{OUT} = 0.5V (SI/O)
I _{OS}	Output Short-Circuit Current	-60		-150	mA	Max	V _{OUT} = 0V
I _{CEX}	Output HIGH Leakage Current			250	μA	Max	V _{OUT} = V _{CC}
I _{ZZ}	Bus Drainage Test			500	μA	0.0V	V _{OUT} = 5.25V
I _{CCH}	Power Supply Current		114	172	mA	Max	V _O = HIGH
I _{CCL}	Power Supply Current		114	172	mA	Max	V _O = LOW

AC Electrical Characteristics							
Symbol	Parameter	T _A = +25°C V _{CC} = +5.0V C _L = 50 pF			T _A = 0°C to +70°C V _{CC} = +5.0V C _L = 50 pF		Units
		Min	Typ	Max	Min	Max	
t _{MAX}	Maximum Clock Frequency	100	130		85		MHz
t _{PLH}	Propagation Delay	3.0	8.0	10.5	2.5	12.0	ns
t _{PHL}	STCP to Q _n	3.0	10.5	13.5	2.5	15.0	
t _{PHL}	Propagation Delay	6.0	16.5	20.5	5.5	22.5	ns
	STMR to Q _n						
t _{PLH}	Propagation Delay	4.0	6.5	8.5	3.5	9.5	ns
t _{PHL}	SHCP to SI/O	4.5	8.0	10.5	4.0	12.0	
t _{PZH}	Output Enable Time	5.0	8.5	11.0	4.0	12.5	ns
t _{PZL}	CS to SI/O	5.5	9.0	11.5	4.5	13.0	
t _{PHZ}	Output Disable Time	3.5	5.5	7.5	3.0	8.5	
t _{PLZ}	CS to SI/O	3.0	4.5	6.5	2.5	7.5	
t _{PZH}	Output Enable Time	4.5	7.5	9.5	4.0	10.5	ns
t _{PZL}	R/W to SI/O	4.5	8.0	10.0	4.0	11.5	
t _{PHZ}	Output Disable Time	3.0	5.5	7.0	2.5	8.0	
t _{PLZ}	R/W to SI/O	2.5	4.0	5.5	2.0	6.5	

AC Operating Requirements						
Symbol	Parameter	T _A = +25°C V _{CC} = +5.0V		T _A = 0°C to +70°C V _{CC} = +5.0V		Units
		Min	Max	Min	Max	
t _S (H)	Setup Time, HIGH or LOW	3.5		4.0		ns
t _S (L)	CS or R/W to STCP	6.0		7.0		
t _H (H)	Hold Time, HIGH or LOW	0		0		
t _H (L)	CS or R/W to STCP	0		0		
t _S (H)	Setup Time, HIGH or LOW	3.0		3.5		ns
t _S (L)	SI/O to SHCP	3.0		3.5		
t _H (H)	Hold Time, HIGH or LOW	3.0		3.5		
t _H (L)	SI/O to SHCP	3.0		3.5		

Physical Dimensions inches (millimeters) unless otherwise noted

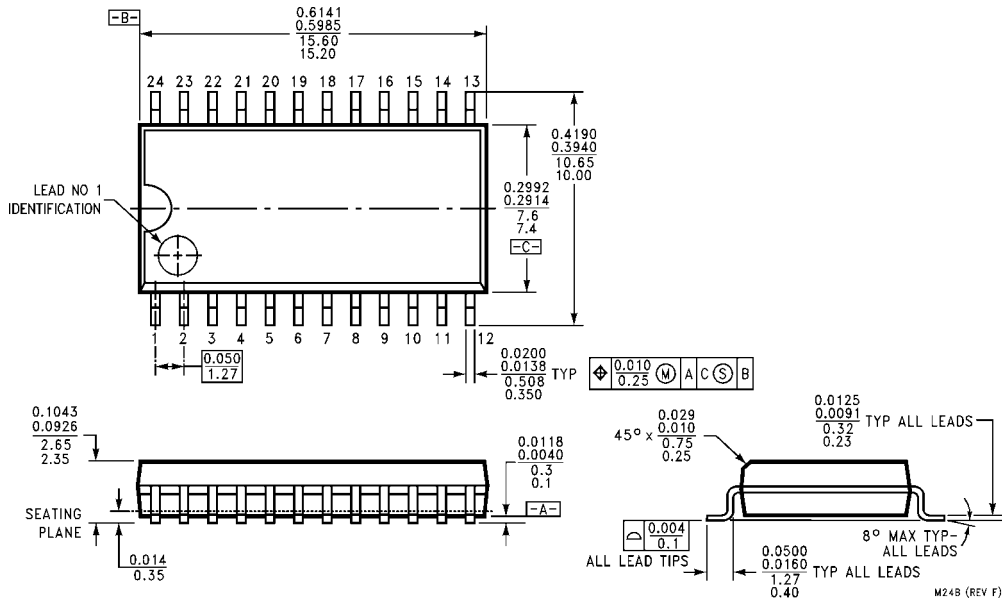

24-Lead Small Outline Integrated Circuit (SOIC), JEDEC MS-013, 0.300 Wide Package Number M24B

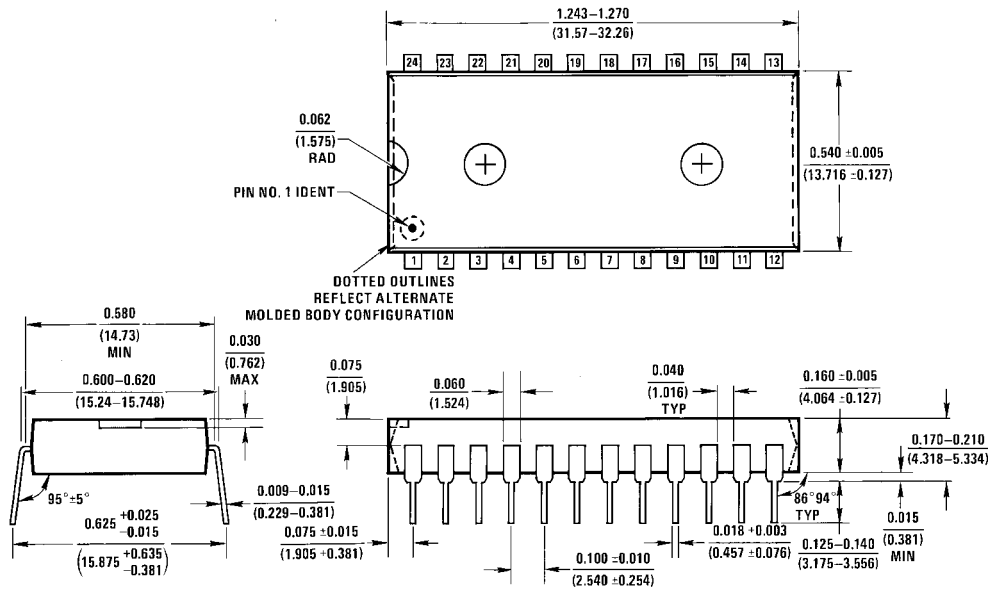

24-Lead Plastic Dual-In-Line Package (PDIP), JEDEC MS-011, 0.600 Wide Package Number N24A

Physical Dimensions inches (millimeters) unless otherwise noted (Continued)

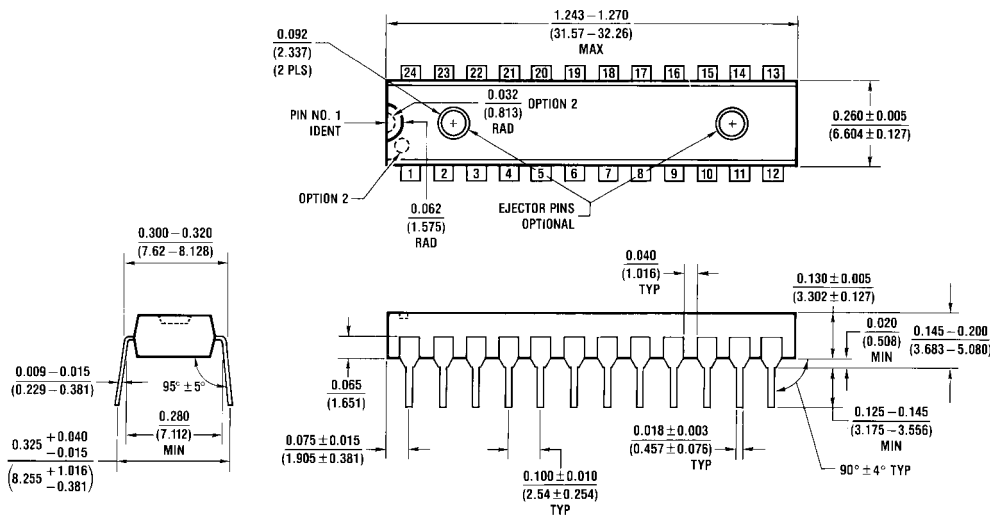

24-Lead Plastic Dual-In-Line Package (PDIP), JEDEC MS-001, 0.300 Wide Package Number N24C

N24C (REV F)

Fairchild does not assume any responsibility for use of any circuitry described, no circuit patent licenses are implied and Fairchild reserves the right at any time without notice to change said circuitry and specifications.

LIFE SUPPORT POLICY

FAIRCHILD'S PRODUCTS ARE NOT AUTHORIZED FOR USE AS CRITICAL COMPONENTS IN LIFE SUPPORT DEVICES OR SYSTEMS WITHOUT THE EXPRESS WRITTEN APPROVAL OF THE PRESIDENT OF FAIRCHILD SEMICONDUCTOR CORPORATION. As used herein:

1. Life support devices or systems are devices or systems which, (a) are intended for surgical implant into the body, or (b) support or sustain life, and (c) whose failure to perform when properly used in accordance with instructions for use provided in the labeling, can be reasonably expected to result in a significant injury to the user.
2. A critical component in any component of a life support device or system whose failure to perform can be reasonably expected to cause the failure of the life support device or system, or to affect its safety or effectiveness.

www.fairchildsemi.com