

LOC		DIST		REVISIONS			
AD	00	REV	DATE	BY	CHKD	APPD	
01		REVISED PER ECO-06-006293	16MAR06	JDP	RW		
02		REVISED PER ECO-09-024606	31OCT09	KK	AEG		

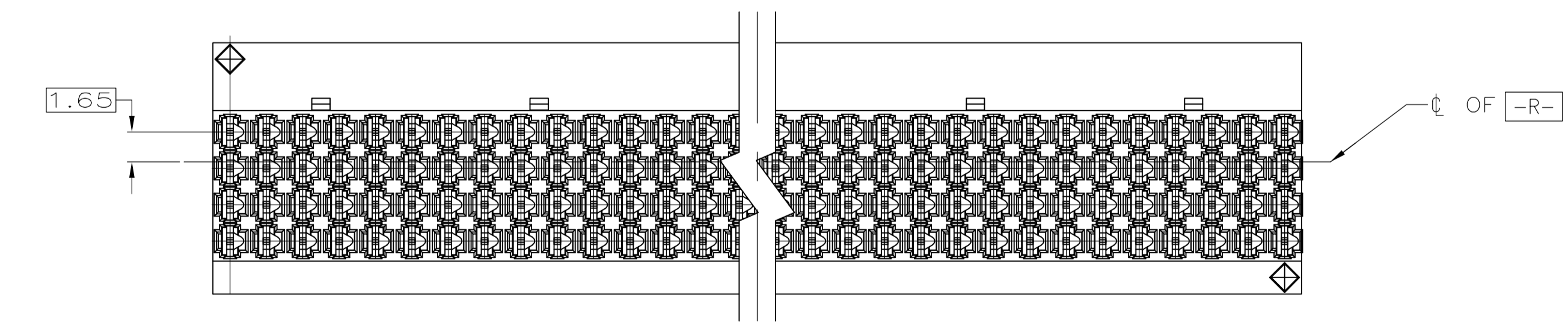

- △ HOUSING MATERIAL: LIQUID CRYSTAL POLYMER. COLOR: NATURAL
- △ CONTACT MATERIAL: PHOSPHOR-BRONZE
- △ CONTACT FINISH:(A)  
 UNDERPLATE (ENTIRE CONTACT):  
 0.00127 MIN NICKEL PER SAE-AMS-QQ-N-290  
 ON MATING SURFACES:  
 CONFORMS TO ALL TESTING SPECIFIED FOR TELCORDIA UNCONTROLLED ENVIRONMENT.  
 ON LEADS:  
 0.00381 MIN MATTE TIN PER ASTM B 545 OVER UNDERPLATE.  
 LUBRICATION (MIN MATING SURFACES):  
 SURFACE CONDITIONER AFTER PLATING.
- △ PART MARKING, LOCATED APPROXIMATELY AS SHOWN.
- △ OBSOLETE PARTS: OBSOLETE CIS STREAMLINING PER D.RENAUD/D.SINISI

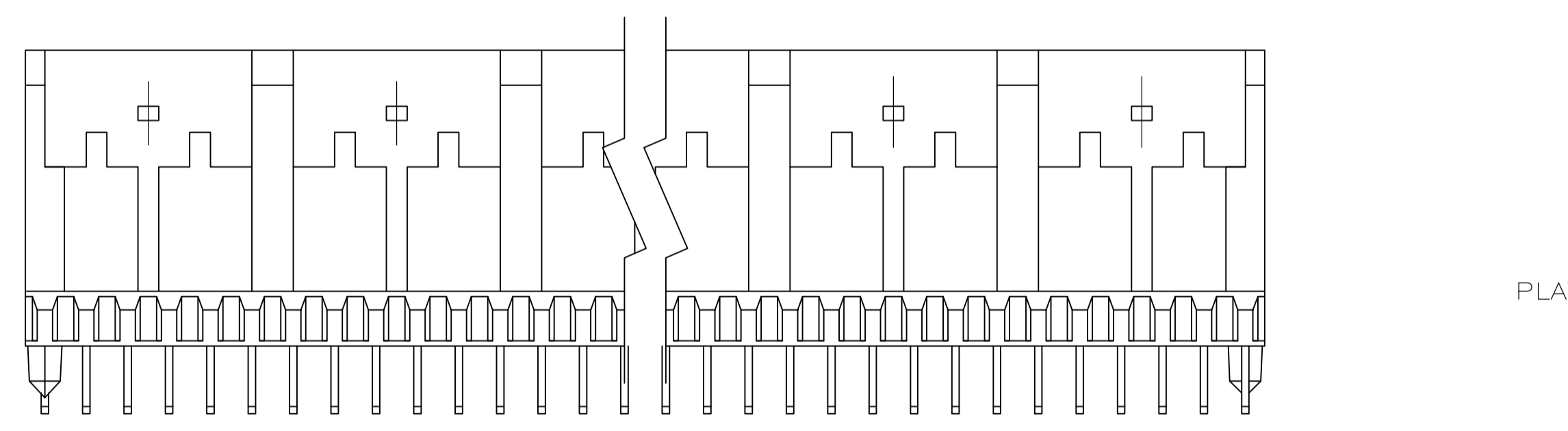
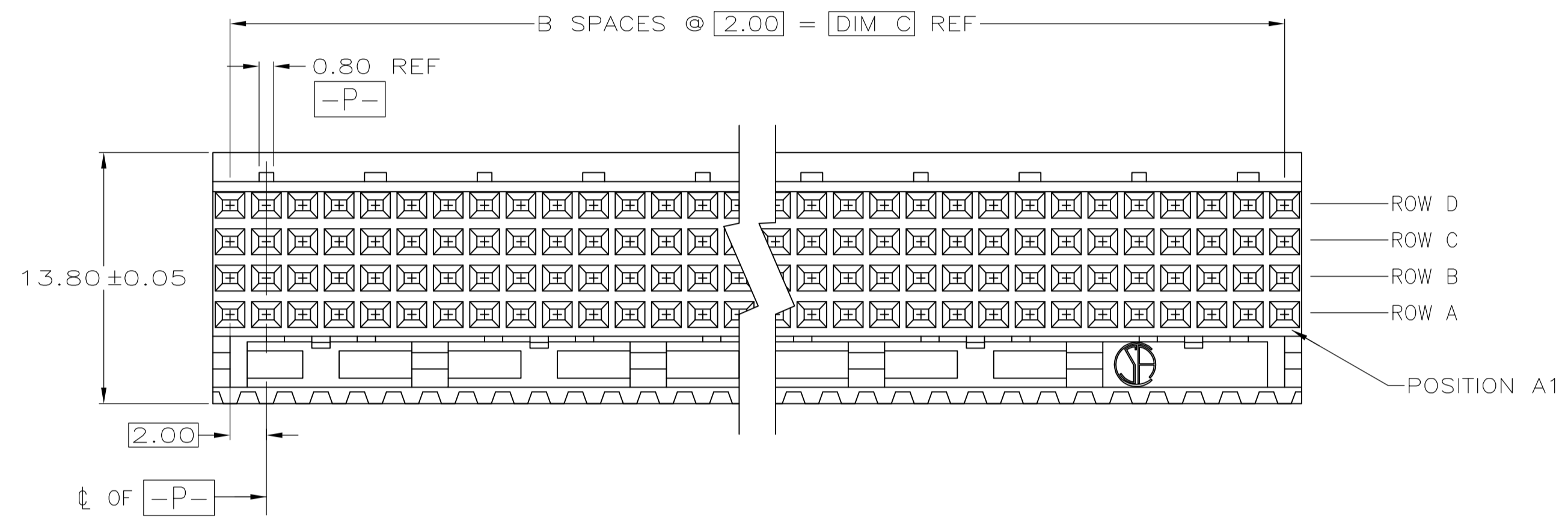
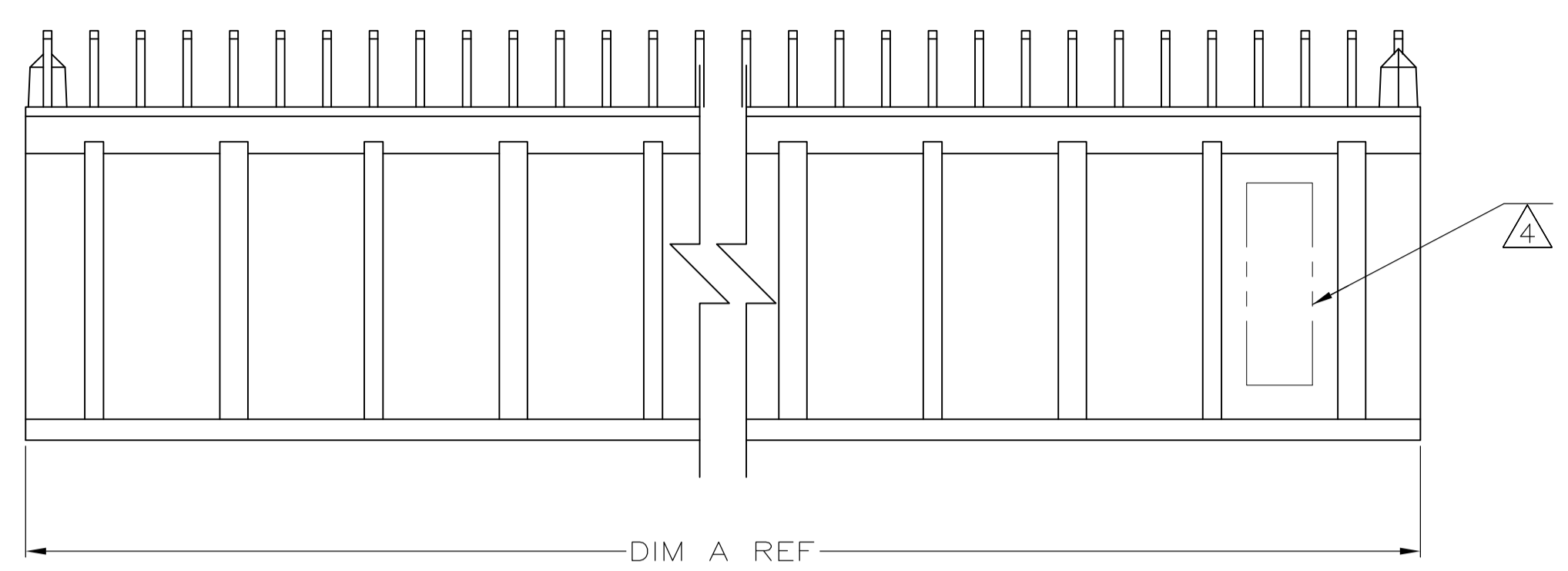
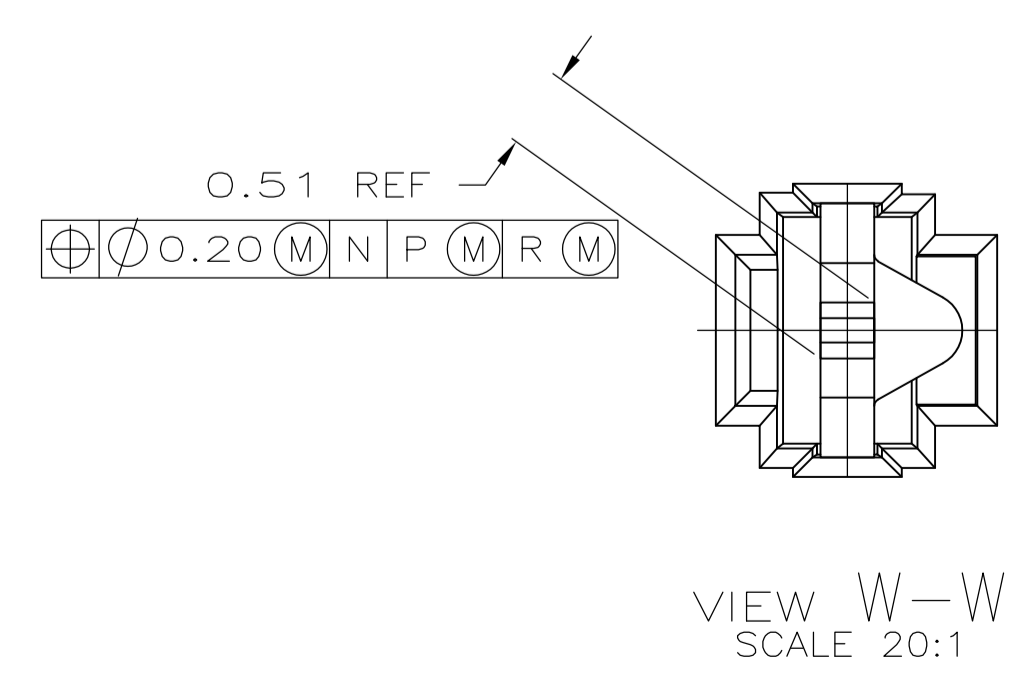
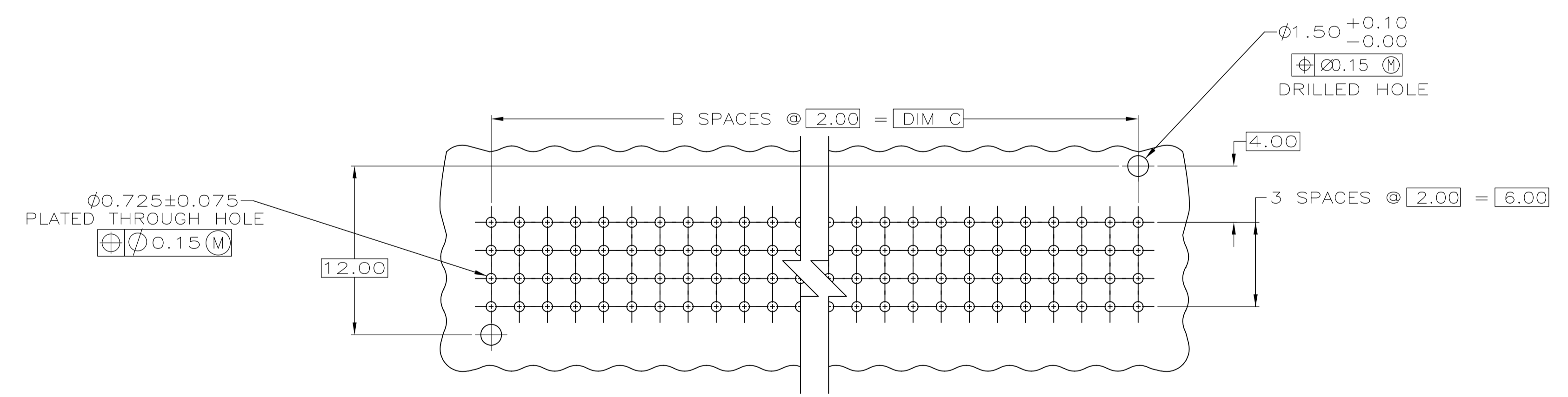
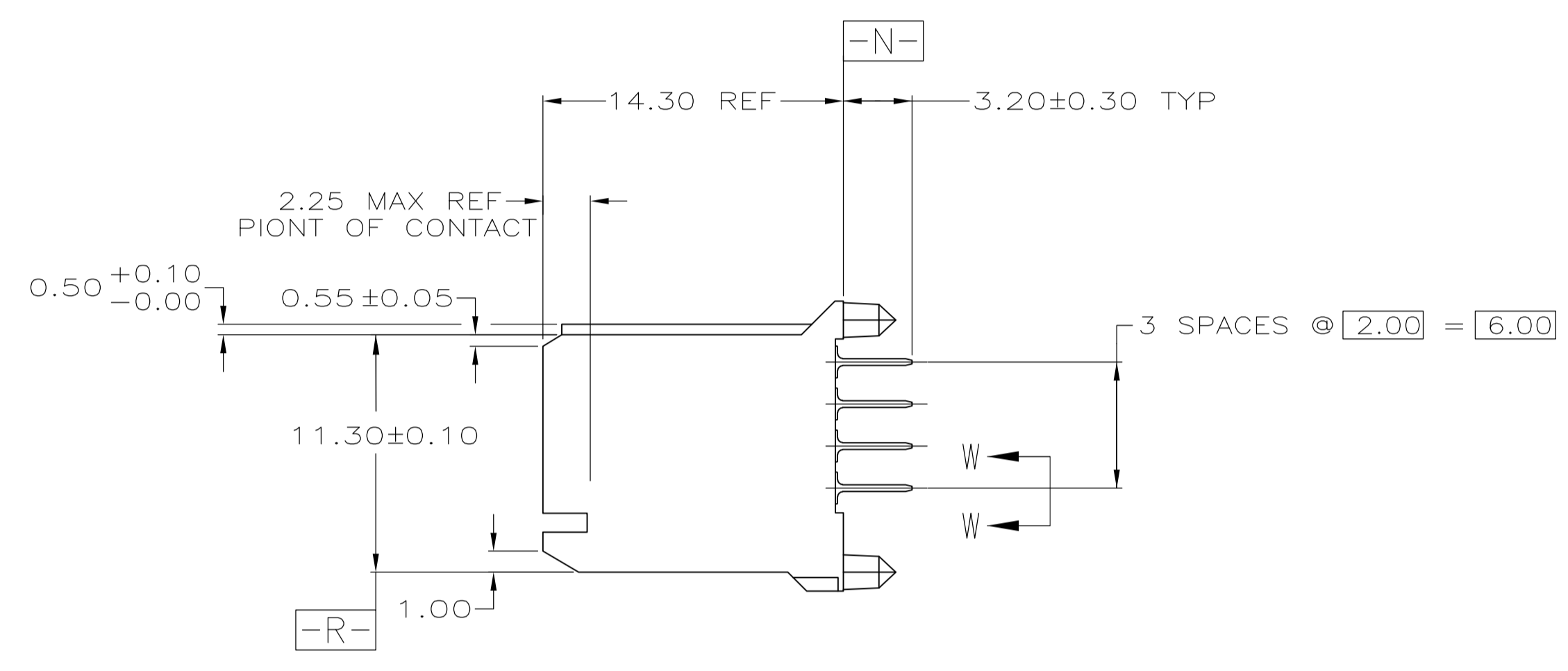

	DIM C	B	DIM A	NUMBER OF SIGNAL POSITIONS	PART NUMBER
OBSOLETE	94.00	47	95.88	192	5223660-8
	82.00	41	83.88	168	5223660-7
	70.00	35	71.88	144	5223660-6
OBSOLETE	58.00	29	59.88	120	5223660-5
	46.00	23	47.88	96	5223660-4
	34.00	17	35.88	72	5223660-3
OBSOLETE	22.00	11	23.88	48	5223660-2
	10.00	5	11.88	24	5223660-1

THIS DRAWING IS A CONTROLLED DOCUMENT.

DIMENSIONS: mm	TOLERANCES UNLESS OTHERWISE SPECIFIED:	DIN B MCMMASTER 16DEC04	APPROVED R WERTZ 16DEC04	Tyco Electronics Corporation Harrisburg, PA 17105-3608
0 PLC ± -	1 PLC ± -	2 PLC ± 0.13	3 PLC ± -	4 PLC ANGLES ± -
MATERIAL	FINISH	SIZE A1	CAGE CODE 00779	DRAWING NO. 5223660
CUSTOMER DRAWING		SCALE 4:1	SHEET 1 OF 1	REV 02