

# Machine **Cybernation**

High Performance & High Capacity



# Compact body loaded with functions equivalent to a medium-scale PLC

## Superior cost performance, and ideal for built-in use

FP2SH is a compact PLC series W140 x H100 x D110 mm W5.51 x H3.94 x D4.33 in (when using 5-module type) loaded with multiple functions, achieving superior cost performance.

The CPU units have an RS232C port as standard equipment, which allows for communications with external equipment, such as a computer or a display panel, and advanced communications for remote monitoring and remote maintenance via a modem. Furthermore, the new intelligent units support wider applications, including full-scale "motor (positioning) control", "analog control", and "networking". This series is perfect as built-in controllers for a variety of systems and equipment.

### CPU units

### Selectable from 4 types, including intelligent types, according to the application

There are 4 types of CPU units, including the standard type and the intelligent type with preinstalled commonly-used advanced functions. This selection allows for more economical system development according to the application.

High-speed operation  
processing  
Adequate programming  
capacity



32 k steps  
Standard type  
**FP2-C2L**  
(AFP2221)

60 k steps  
Standard type  
**FP2-C2**  
(AFP2231)

60 k steps  
For small PC card  
**FP2-C2P**  
(AFP2235)

120 k steps  
For small PC card  
**FP2-C3P**  
(AFP2255)

### Body size

### The front face is smaller than an A6 sheet of paper.

The front face area is W140 x H100 mm W5.51 x H3.94 in (when using five modules), which is small enough to fit completely on an A6 sheet of paper.

The compact body requires minimum installation space.

\* Depth: 108.3 mm 4.26 in

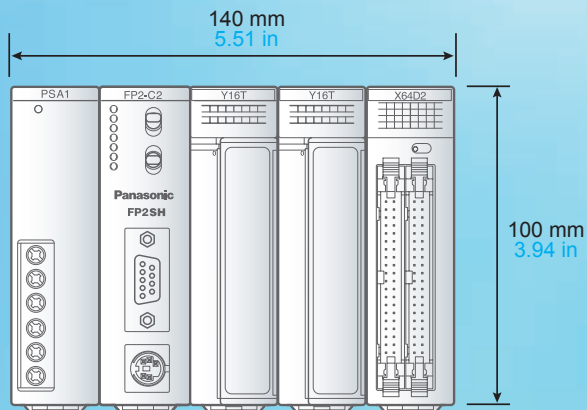



Programmable Controller **FP2SH**

## Memory and I/O control

Equipped with an adequate large capacity program memory and operation memory

The compact size unit can have a large capacity program memory, which can be selected among 32 k, 60 k, and 120 k steps types. A variety of operation memory types are also available.

Also, the maximum controllable I/O points is 2,048 points (8,192 points when using remote I/O system), which is sufficient for medium-scale control.

### ■ Addition of optional memory

An IC memory card can be used in the CPU unit as program memory or expanded data memory.

### ■ I/O point expansion by adding backplanes

#### Conventional backplane

Only one backplane can be added to one master backplane. When both the master and expansion backplanes are of the 14-module type, up to 1,600 I/O points can be controlled.

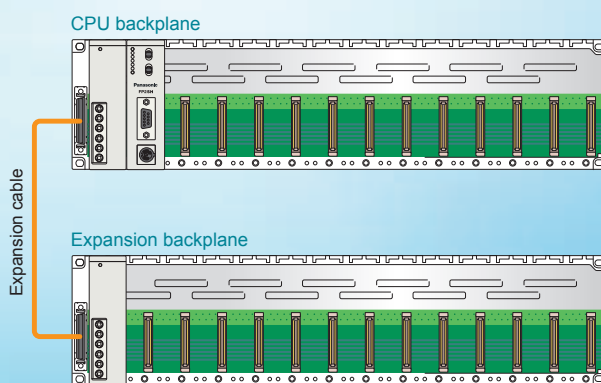

(The backplane can be used as either a master or expansion backplane.)

#### H type backplane

Up to three backplanes can be added to one master backplane. A maximum of 32 units can be connected, and up to 2,048 I/O points can be controlled, values surpassing those of the conventional backplane expansion system (25 units/1,600 points).

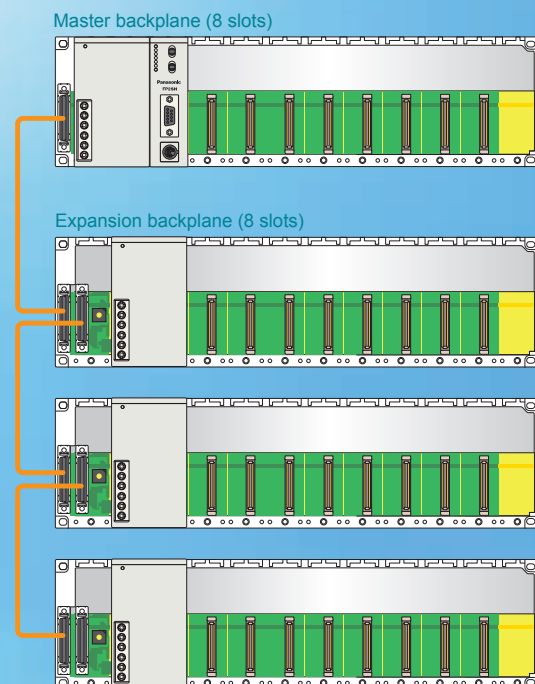

	Conventional type	H type
Max. number of backplanes	1 + 1 = 2 backplanes	1 for master + 3 for expansion = 4 backplanes
Max. number of units	12 + 13 = 25 units	8 + 8 x 3 = 32 units
Max. number of I/O points	25 x 64 = 1,600 points	32 x 64 = 2,048 points
Max. cable length	1 cable, 2 m <b>6.6 ft</b>	3 cables, 3.2 m <b>10.5 ft</b>

\* The H type and conventional type cannot be used in combination.

## Network compatibility

Support a wide variety of networks, such as open networks, PLC links, remote I/O systems.

### Open networks

#### PROFIBUS DP, DeviceNet, CANopen

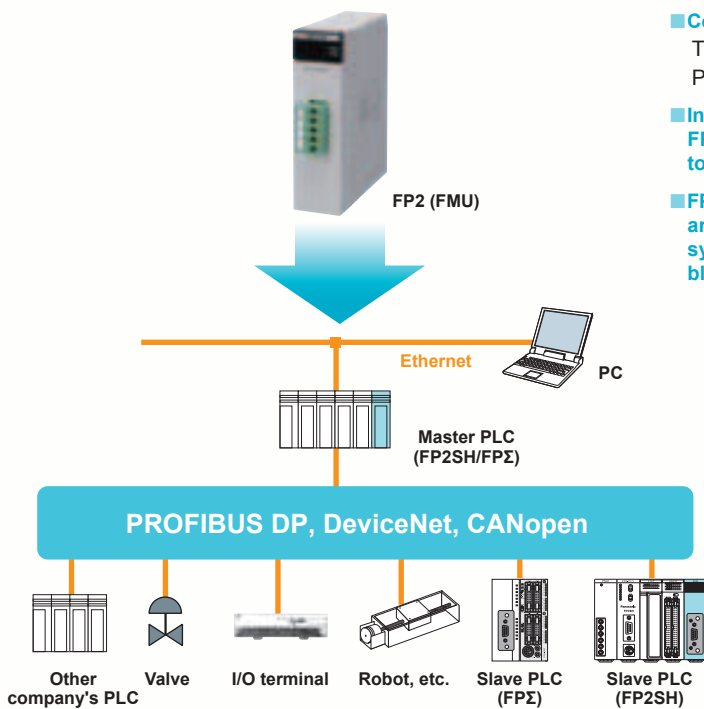

#### Compatible with major fieldbuses around the world

The **FP2** and **FPΣ** series include master units compatible with PROFIBUS DP/DeviceNet/CANopen.

#### In combination with the Flexible Network Slave Unit (FNS), FP2SH can serve as either a master or slave unit, allowing for total system construction.

#### FP2SH can be compatible with major open networks used around the world and easily incorporated into a multivendor system by attaching one of the selectable communication blocks to the FNS unit.

[Related product] Flexible Network Slave Unit (FNS)

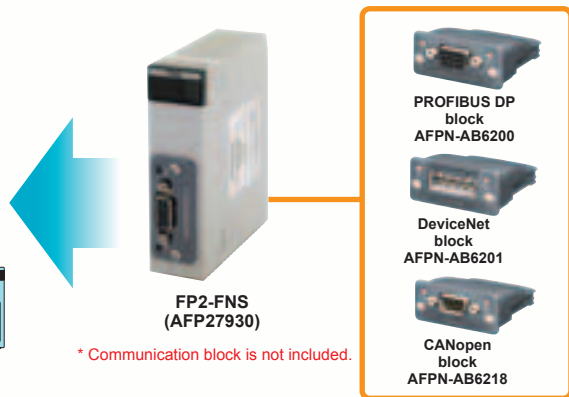

### Features

- 1 The FNS unit can be made compatible with three networks by changing the attached communication block without replacing the main unit (FP2-FNS), thereby reducing the stock of maintenance parts.
- 2 Libraries useful for building applications are available (for Control FPWIN Pro). The setup man-hours can be significantly reduced.



Note: Since the above libraries are used for setting up the FNS unit, **Control FPWIN Pro** (Ver. 5.24 or later) is required. **Control FPWIN GR** cannot set up the unit.

### The unit and control panel can be arranged in advance.

When a production line is introduced in an overseas plant for example, it is possible that you have already decided to adopt an open network for line control/management, but have not yet determined which is the optimum network to adopt: PROFIBUS, DeviceNet, or CANopen. Even in such cases, you can install the FNS unit and start manufacturing the panel first, and then choose the communication block to be attached after determining which network should be adopted, shortening the work period.

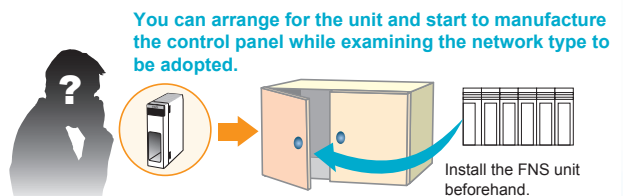

### Maintenance part stocks can be reduced.

When a plant adopts multiple network types, the plant can reduce the stock of maintenance parts by keeping only the FNS unit and communication blocks in stock rather than whole units that are compatible with only one network type.

When different units exist for different networks types

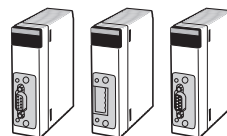

With the FNS unit

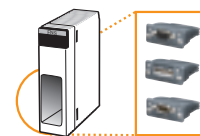



## FL-net

"FL-net is a responsive high-performance network for factory automation based on Ethernet. The Japan Electrical Manufacturers' Association started FL-net certification in April 2000."

FL-net is now rapidly spreading into various fields, including manufacturing, food, medical, packaging, printing industries and public/social systems.

### [FL-net function of the VE link unit]

- 1 10 Mbps high-speed link
- 2 Large link area of 8 k points / 8 k words
- 3 Max. 254 nodes (stations)



FP2-VE2  
(AFP279601)

## Ethernet

- 1 Supports two communications interfaces: 100BASE-TX and 10BASE-T
- 2 Supports TCP/IP and UDP/IP.
- 3 Communications among a maximum of eight connections are available.
- 4 Compatible with user-friendly MEWTOCOL communication.
- 5 Supports remote programming.

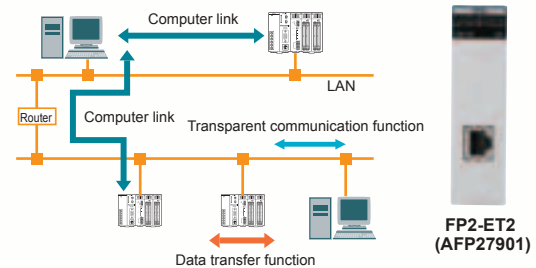

FP2-ET2  
(AFP27901)

## PLC link

The PLC link is a system that allows our PLCs to share contact data and word data without programming.

### VE mode

High-speed, large-capacity PLC link using the VE link unit based on Ethernet

- 1 10 Mbps high-speed link
- 2 Large link area of 8,192 points / 8,192 words
- 3 Up to 99 units can be connected.
- 4 Extendable to 2,500 m **8,202 ft**

\* When using a repeater



FP2-VE2  
(AFP279601)

### MEWNET-W0 mode

A PLC link of the compact high-performance PLC **FPΣ** and **FP-X** can be established by using a combination of the multi-communication unit and an RS485 communication block. This mode enables the efficient connection of **FP2SH**, **FPΣ**, and **FP-X** units on a single network and contributes to significant cost reduction.

- 1 115.2 kbps transmission speed
- 2 Transfer of data of 64 points / 128 words is possible.
- 3 Up to 16 units can be connected.
- 4 Extendable to 1,200 m **3,937 ft**



FP2-MCU  
(AFP2465)

### MEWNET-W2 mode

Large capacity PLC links can be established by using twisted-pair cables and multi-wire link units.

- 1 500 kbps transmission speed
- 2 Transfer of data of 4,096 points / 4,096 words is possible.
- 3 Up to 32 units can be connected.
- 4 Extendable to 1,200 m **3,937 ft**



FP2-MW  
(AFP2720)

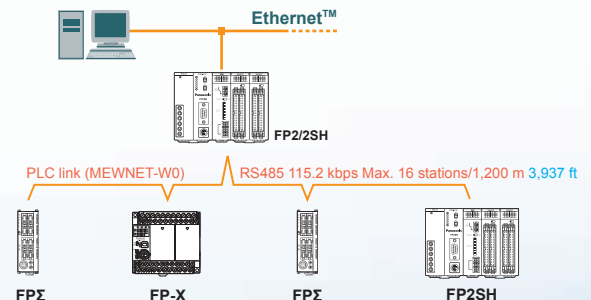
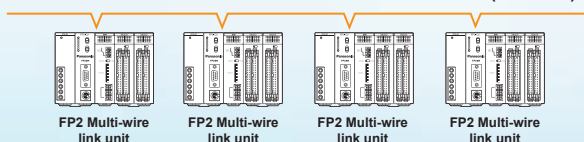

\* Each **FPΣ** also requires that an RS485 type **FPΣ** communication cassette (**AFPG803** or **AFPG806**) be attached.

\* Each **FP-X** requires that **AFPX-COM3** or **AFPX-COM4** communication cassette be attached.

## Remote I/O systems

### MEWNET-F mode

The use of Multi-wire link units allows for up to 8,192 I/O points, up to 32 stations, and up to a 700 m 2,297 ft transmission distance.

- MEWNET-F is a remote I/O system that connects I/O units in separate locations with 2-wire cable.
- Up to four wiring routes are available, allowing for a complicated layout of slave stations.
- The Multi-wire link unit serves as a master station of remote I/O system. Slave stations can be selectable from the units shown below.
- This network system is ideal for cases where I/O units need to be installed in separate locations or in a location away from the control box.

FP2SH can be used as a remote I/O slave station by attaching the FP2 Remote I/O slave unit on the backplane. On the backplane, I/O units, Serial data units, and S-LINK units can be mounted, allowing for building a multipoint multifunctional slave station.

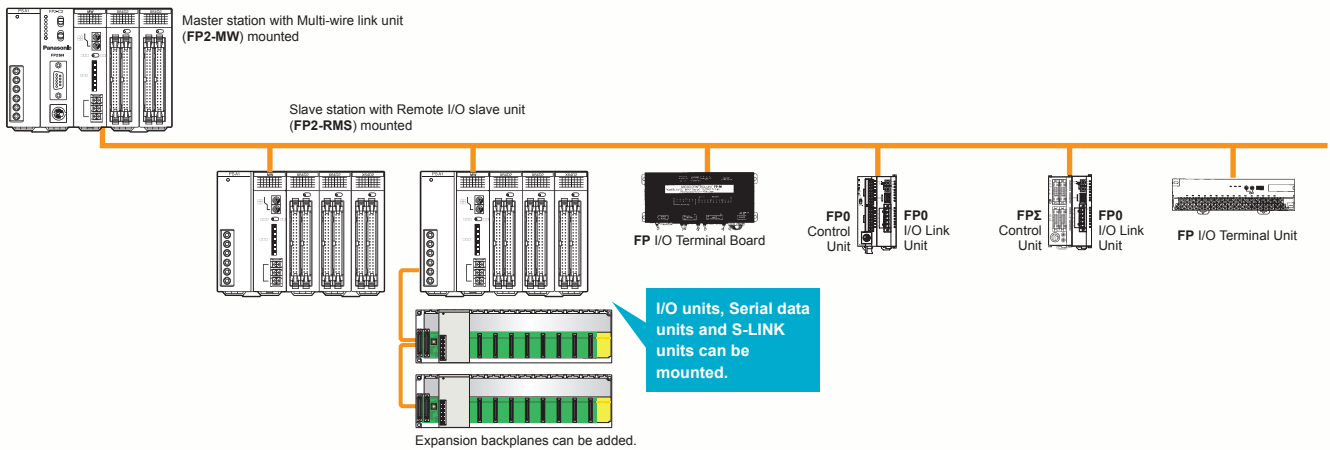

### S-LINK

- S-LINK is wire-saving system that allows the free layout of I/O devices, such as sensors, by T-branch connections with a 4-wire flat cable.
- The number of I/O points can be increased up to 2,048 points in increments of one channel having 128 points.
- Sensors to be connected by S-LINK must be chosen from S-LINK-compatible sensors.



S-LINK unit

Note: The number of I/O points may be less than 128 points depending on the connected model and connection location. For details, please refer to the S-LINK manual.

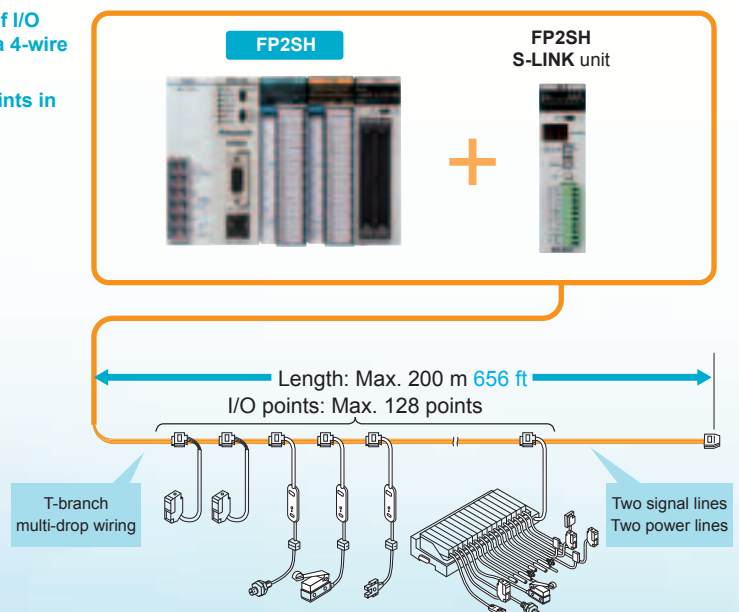

## Serial communication control

The CPU units have an RS232C port as standard equipment. The communication unit enables connections with RS232C, RS485 and RS422-compatible devices.

### ■ CPU units

All CPU units have an RS232C port as standard equipment. They can be directly connected to a host computer or a display panel, and can also be connected to a modem to collect data from and change programs in devices in a remote location.



[Direct connection to operation display panel or computer]

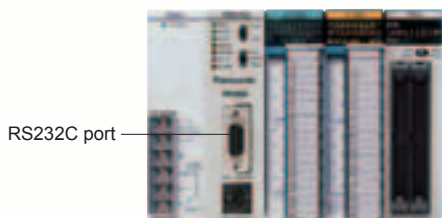

RS232C port

FP2SH

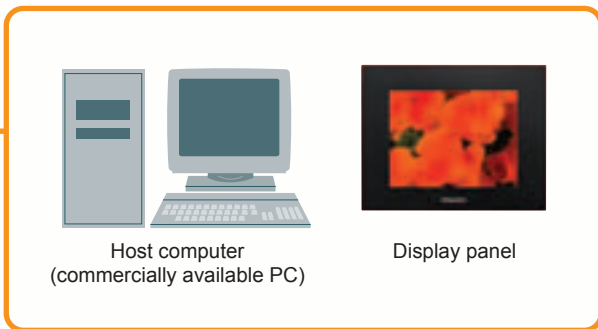

Host computer (commercially available PC)

Display panel

### ■ Multi-Communication Unit (MCU)

The serial communication blocks are detachable.

Up to two blocks to be attached can be selected among RS485, RS232C, and RS422 blocks.



FP2-MCU (AFP2465)

High-speed communication

The 230 kbps communication speed (simultaneous two channels) facilitates fast large-volume data communications.

[Selectable from three communication blocks]

The use of only one channel is also possible.

RS232C



FP2-CB232 (AFP2803)

RS422



FP2-CB422 (AFP2804)

RS485



FP2-CB485 (AFP2805)

The combination is selectable.

COM2 (the lower channel) is sealed before shipping so that it can be protected from damage even when only COM1 is used.



Multi-Communication Unit FP2-MCU (AFP2465)

\* This unit cannot operate without a communication block attached. Purchase the communication block together with this unit.

## Motor control

### Positioning Unit RTEX

#### Compatible with Realtime Express MINAS A4N/A5N\*1 network servo systems Facilitate multi-axis high precision positioning (A5N is supported from Ver. 1.3.)

- High-accuracy multi-axis positioning control achieved by high-speed 100 Mbps communications
- Compatible with commercially-available LAN cables, significantly reducing wiring costs
- 2 axes type available in addition to the 4 axes and 8 axes types
- Position data up to 600 points can be registered for each axis.
- Three axes spiral interpolation supported in addition to two axes linear and two axes circular interpolation
- Dedicated tool software Configurator PM supports operations from setup through startup and monitoring.
- Equipped with a manual pulser input, allowing for fine teaching

\*1 Realtime Express and MINAS A4N/A5N are a trademark and a product name of Panasonic Corporation Appliances Company Motor business unit. Mixed use of MINAS A4N and A5N is not possible.

High-speed communications 100 Mbps!

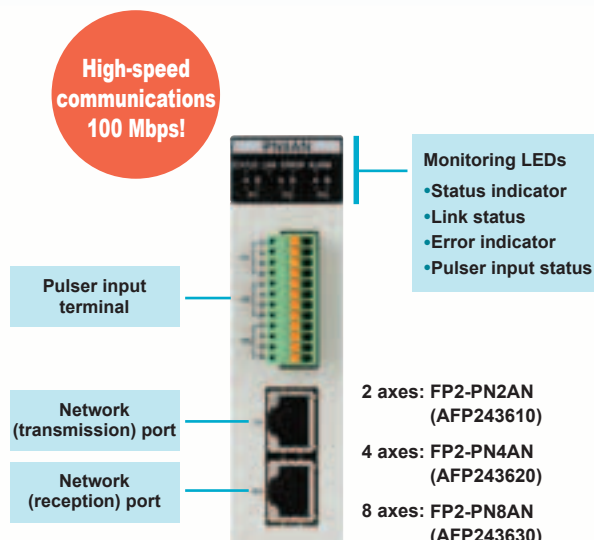

#### Compatible with commercially-available LAN cables, providing overwhelming advantages in economy and availability

Realtime Express\*1 has adopted a commercially-available LAN cable as its network cable, providing overwhelming advantages in economy, availability, and workability for your wiring work.

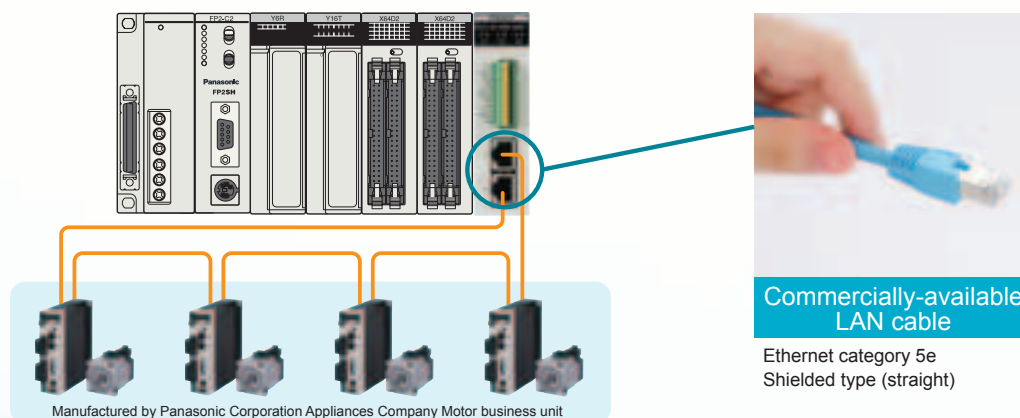

New function added

- 1 Positioning repeat function ..... Effective for wire winding machines, grinding machines, and other equipment that repeats the same operation.
- 2 Home return methods added ..... Eight methods that help the simplification of equipment, including limit-stop and contact-stop methods, were added.
- 3 Synchronized operation ..... Two sets consisting of one master axis and one slave axis can be designated. Ideal for dual-axis table transfer.
- 4 Real-time torque limiting ..... The torque limit value can be changed any time during operation. Ideal for axis push-in control.
- 5 JOG operation positioning control ..... The operation slows to a stop at a fixed position according to a sensor input. Ideal for labelers.
- 6 Auxiliary contact (Delay mode) ..... The auxiliary contact output is possible any time during positioning.
- 7 Current value changing function ..... The value of current position can be changed to any value. Usable for zero offset.
- 8 Operation during the system startup changed ..... The unit startup was made possible even if the servo amplifier's main power is not turned on.



## Controls up to 256 axes, adequately supporting large-scale equipment control

- Up to 8 axes type 32 units can be connected, and up to 256 axes can be controlled. (when using H type backplane).
- Selectable among 2, 4, and 8 axes types to flexibly support system configurations of a few or multiple axes
- Use in combination with the ultra-high speed and large capacity CPU unit [20 k steps/1 ms (measured by our company), program capacity of 120 k steps] adequately supports the control of large-scale equipment.

### System configuration

[Maximum number of connectable Positioning Unit RTEX: 32 units] [One Positioning Unit can control two to eight axes (depending on the type).]

\* Servo amplifier MINAS A5N  
Manufactured by Panasonic Corporation Appliances Company Motor business unit

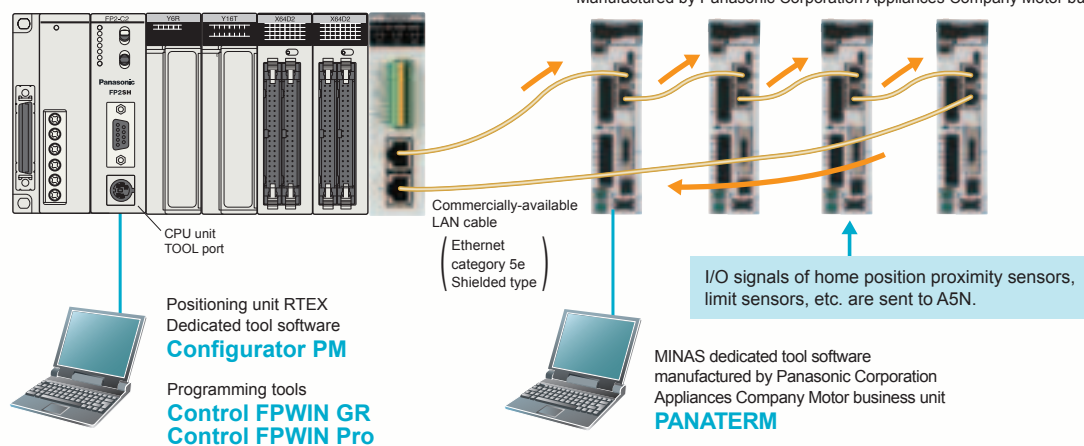

### Dedicated setting tool software Configurator PM

Reliable and user-friendly software tool for the process from setting through startup and operation monitoring for the functions, including specification of axes to be used, parameter setting, data table creation, JOG operation, home return, and data monitoring.



## The use of the servo amplifier with four built-in general-purpose I/O points eliminates the need for a remote I/O terminal.

The servo amplifier has two DC inputs and two DC outputs, which serve as X and Y respectively for the PLC via a network. Signal inputs from various sensors and lamp-lighting outputs for a local control axis can be controlled by a PLC, eliminating the costs required for adding a remote I/O system for such control.

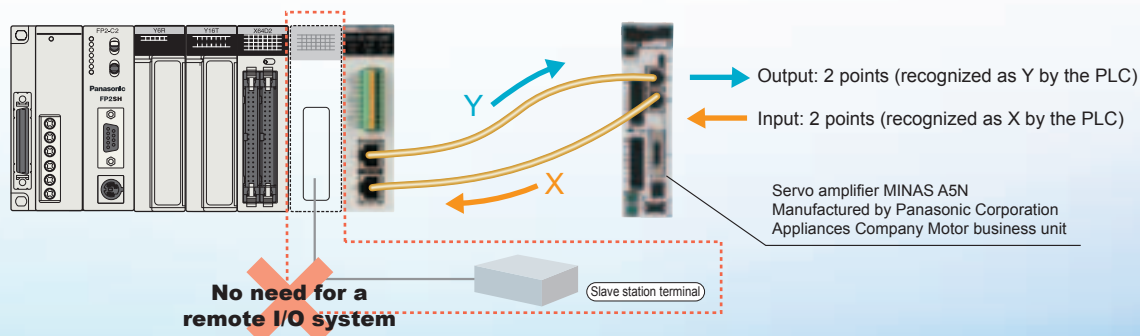

## Positioning Unit (Multi function type)

### High-speed, high-accuracy pulse output type positioning unit Speed command: 4 Mpps, Startup time: 0.005 ms

Support pulse-input type stepping motors, and servomotors.  
The speed command range is up to 4 Mpps, allowing for high-speed and high-accuracy positioning.  
The startup time is as high as 0.005 ms, allowing for a reduction of the tact time.  
(Startup time: Time between reception of a command from a CPU unit and pulse output from a positioning unit)

- **Feedback pulse count function** Counts output pulses from encoders or other devices
- **The jog positioning control widens the supported application range.**
- **The four types of S-curve acceleration/deceleration control allow for smooth startup and stoppage.**
- **Program libraries for linear interpolation and other operations are available.**

"Function Libraries for FPCWIN Pro" can be downloaded from our website:

<http://panasonic.net/id/pidsx/global>

- **Motor Driver I/F Terminal II is available for connection with MINAS series AC servomotors.**



For 1 axis (AFP8503)



For 2 axes (AFP8504)



	Positioning Unit (2 axes)	Positioning Unit (4 axes)
Line driver	FP2-PP22 (AFP2434)	FP2-PP42 (AFP2435)
Transistor	FP2-PP21 (AFP2432)	FP2-PP41 (AFP2433)

#### [Configuration]

One unit can control up to 4 axes.

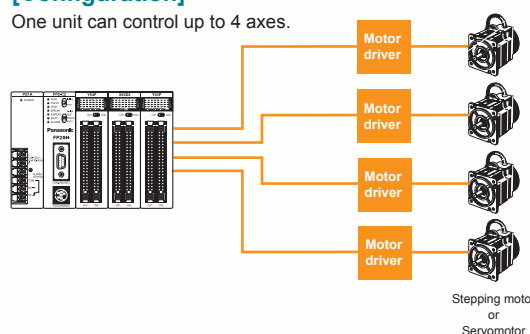

## Positioning Unit (Interpolation type)

Compatible with synchronized operation and interpolation control, easily building systems for applications, such as the parallel translation of transfer tables, cutting, X-Y table control, palletizing, and winding machine



	Positioning Unit (2 axes)	Positioning Unit (4 axes)
Line driver	FP2-PP2L (AFP243711)	FP2-PP4L (AFP243721)
Transistor	FP2-PP2T (AFP243710)	FP2-PP4T (AFP243720)

### ■ Dedicated setting tool software Configurator PM

Reliable and user-friendly software tool for the process from setting through startup and operation monitoring for the functions, including specification of axes to be used, parameter setting, data table creation, JOG operation, home return, and data monitoring.



[Two axes synchronization operation]

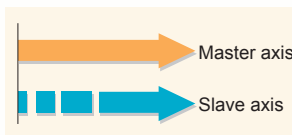

[Two axes linear interpolation]

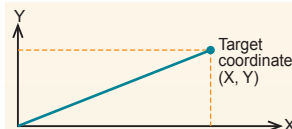

[Two axes circular interpolation]

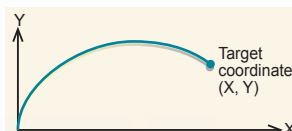

[Three axes linear interpolation]

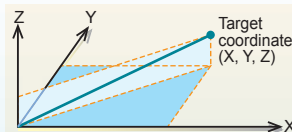

[Three axes spiral interpolation]

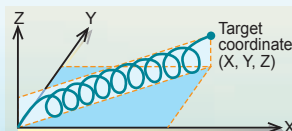

## Analog control

Multi-range control of a variety of equipment is possible. The unit can be directly connected with thermocouples and Resistance Temperature Detectors (R.T.D.).

### Support voltage/current/temperature sensor ranges.

The analog input supports voltage, current, and temperature sensors. The analog output supports voltage or current. Different voltage/current ranges can be controlled concurrently

### Equipped with multiple channels

The input unit has 8 channels, and the output unit has 4 channels. Space-saving and multiple-channel control is possible.

### High-speed conversion at 500 μs by each channel

The conversion speed of voltage and current input/output can reach as high as 500 μs.

### I/O refresh system

Since input/output data is allocated to the I/O memory, complicated programming is not necessary.

### [Configuration]

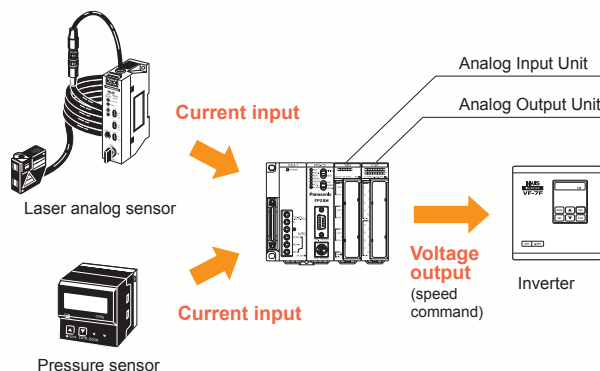

## Analog input types

Three types of analog input units are available to meet a wide variety of customer needs.

### High-speed, high-accuracy, multiple-input type with isolated channels

High speed

Highly reliable isolation among channels  
**Temperature conversion: 20 ms/ch**  
**Voltage conversion: 5 ms/ch**  
 (Without insulation setting: 500 μs/ch)

High accuracy

High accuracy conversion  
**Voltage: ±0.1 % (25 °C 77 °F)**  
**Temperature: ±0.3 % (0 to 55 °C 32 to 131 °F)**

Multiple inputs

A single unit supports inputs of thermocouple, R.T.D., and voltage \*1 **FP2-AD8X (AFP2401)**



- For users who require faster and more accurate temperature control
- For users who require multiple with isolated channels or who want to reduce the cost per one channel
- For users who want to input temperature and voltage (current) data through a single unit

\*1 Current inputs can be converted into voltage inputs by attaching the supplied external resistor to the input terminal section.

### Input unit solely for R.T.D. (Pt100 / Pt1000)

High-speed and high accuracy

**Conversion speed: 20 ms/ch**  
**Conversion accuracy: ±0.3 % (0 to 55 °C 32 to 131 °F)**

- For users who R.T.D. input only and require more affordable type

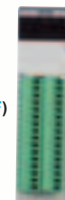

**FP2-RTD (AFP2402)**

### Low cost input solely for voltage/current data

- Low cost type for input of voltage/current data that indicates measurements of pressure, flow rate, fluid volume, speed, etc.



**FP2-AD8VI (AFP2400L)**

## Analog output type

Supports multiple channels. (4 channels per one unit)

High-speed and high accuracy

**Conversion speed: 500 μs/ch**  
**Over accuracy: ±1.0 %F.S. or less**  
 (0 to 55 °C 32 to 131 °F)

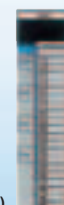

**FP2-DA4 (AFP2410)**

# FP2SH

## Scanning time of 1 ms for 20 k steps. A high-performance model for high-speed operation.



- Operation speed:  
30 ns
- Maximum I/O points:  
2,048 points
- Program capacity:  
Max. 120 k steps
- Open network  
PROFIBUS Modbus-RTU  
DeviceNet CC-Link  
CANopen Ethernet
- Positioning:  
network servo,  
Max. 256 axes
- Positioning:  
pulse output 4 Mpps,  
start up: 0.005 ms



### ■ Features

- 1. Scanning time of 1 ms for 20 k steps**  
The program of 20 k steps can be executed in 1 ms. The result is a dramatically decreased tact time and high-speed device.
- 2. Large programming capacity: Maximum 120 k steps**  
Both the large programming capacities of 32 k, 60 k and 120 k are available depending on the model.
- 3. Optional small PC card is also available.**  
The small PC card is available for programming backup or data memory expansion. This allows data processing of great amounts of data.
- 4. Built-in comment and calendar timer functions.**  
These functions, options with the FP2, are built right into the FP2SH.  
\* The I/O units and intelligent units are the same for the FP2 series.

### ■ Power supply and I/O specifications

Item	Specifications
Power supply	100 to 120 V AC, 200 to 240 V AC, 100 to 240 V AC, 24 V DC (varies with different units)
Input	12 to 24 V DC, 24 V DC ± common
Output	Relay output: 2 to 5 A, Transistor output: 0.1 to 0.5 A (varies with different units)

### ■ Supported functions

Item	Specifications
Analog I/O	Available by adding Analog input and Analog output units.
High-speed counter	Available by adding High-speed counter unit. (Max. 200 kHz)
Positioning	Available by adding Positioning unit. (Max. 4 Mpps) * The RTEK-compatible positioning unit is also available.
Serial communication	RS232C port Standard equipped with CPU unit. Expandable by adding Computer communication unit (CCU), Serial data unit and Multi-communication unit (MCU)
	RS422 RS485 Expandable by adding Multi-communication unit (MCU)
Interrupt input	Available by adding High-speed counter unit or Pulse I/O unit.

### ■ Performance specifications

Item	Specifications
Number of controllable I/O points	Up to 768 points per one board
Expansion	Standard Up to one backplane, Max. 25 units I/O points: Max. 1,600 points Remote I/O points: Max. 8,192 points
	H type Up to three backplanes, Max. 32 units I/O points: Max. 2,048 points Remote I/O points: Max. 8,192 points
Operation speed	0.03 μs / step (for basic instruction)
Built-in memory	RAM (ROM / small PC card is optional)
Memory capacity	32 k steps approx. / 60 k steps approx. / 120 k steps approx. (varies with different units)
Operation memory	Internal relay 14,192 points
	Timer / Counter 3,072 points in total
	Data register 10,240 words
	File register 32,765 words × 3 (60 k / 120 k steps) 32,765 words (32 k steps)

### ■ Supported networks

Item	Specifications
Open network	Ethernet FL-NET PROFIBUS DeviceNet CANopen
Remote I/O	S-LINK, S-LINK V or MEWNET-F
PLC link	MEWNET-W2 (Wire), MEWNET-WO, MEWNET-VE or FL-NET
Computer link	Linkable by using tool port or COM. port on CPU unit. Also available by adding Multi-communication unit (MCU) and Computer communication unit (CCU)
Modem connection	Available

### ■ Other built-in functions

Item	Specifications
Program edition during RUN	Available
Constant scan	Available
Calendar timer	Built-in type



**List of Related Part No. Programmable Display GT series**

Product name	Description					Part No.
	LCD	Power supply	Communication port	Color of front panel	SD memory card slot	
<b>Tough</b> GT32M-E	TFT monochrome LCD	24 V DC	RS232C	Silver	Available	AIG32MQ03DE
			RS422 / RS485			AIG32MQ05DE
<b>Tough</b> GT32T-E	TFT color LCD	24 V DC	RS232C	Silver	Available	AIG32TQ03DE
			RS422 / RS485			AIG32TQ05DE
GT02L	STN monochrome LCD (white backlight)	5 V DC	RS232C	Black	Not available	AIG02LQ02D
			RS422 / RS485			AIG02LQ04D
GT02M	STN monochrome LCD (white/pink/red backlight)	5 V DC	RS232C	Pure black	Not available	AIG02MQ02D
				Hairline silver		AIG02MQ03D
			RS422 / RS485	Pure black		AIG02MQ04D
				Hairline silver		AIG02MQ05D
		24 V DC	RS232C	Pure black		AIG02MQ12D
				Hairline silver		AIG02MQ13D
			RS422 / RS485	Pure black		AIG02MQ14D
				Hairline silver		AIG02MQ15D
		24 V DC	RS232C	Pure black	Available	AIG02MQ22D
				Hairline silver		AIG02MQ23D
			RS422 / RS485	Pure black		AIG02MQ24D
				Hairline silver		AIG02MQ25D
GT02G	STN monochrome LCD (green/orange/red backlight)	5 V DC	RS232C	Pure black	Not available	AIG02GQ02D
				Hairline silver		AIG02GQ03D
			RS422 / RS485	Pure black		AIG02GQ04D
				Hairline silver		AIG02GQ05D
		24 V DC	RS232C	Pure black		AIG02GQ12D
				Hairline silver		AIG02GQ13D
			RS422 / RS485	Pure black		AIG02GQ14D
				Hairline silver		AIG02GQ15D
		24 V DC	RS232C	Pure black	Available	AIG02GQ22D
				Hairline silver		AIG02GQ23D
			RS422 / RS485	Pure black		AIG02GQ24D
				Hairline silver		AIG02GQ25D
GT05M	STN monochrome LCD (white/pink/red backlight)	24 V DC	RS232C	Pure black	Available	AIG05MQ02D
			Hairline silver	AIG05MQ03D		
GT05G	STN monochrome LCD (green/orange/red backlight)	24 V DC	RS232C	Pure black	Available	AIG05GQ02D
			Hairline silver	AIG05GQ03D		
GT05S	STN color LCD	24 V DC	RS232C	Pure black	Available	AIG05SQ02D
			Hairline silver	AIG05SQ03D		
GT12M	STN monochrome LCD (white/pink/red backlight)	24 V DC	RS232C	Pure black	Not available	AIG12MQ02D
			Hairline silver	AIG12MQ03D		
GT12G	STN monochrome LCD (green/orange/red backlight)	24 V DC	RS232C	Pure black	Not available	AIG12MQ04D
			Hairline silver	AIG12MQ05D		
GT12Q	STN monochrome LCD (green/orange/red backlight)	24 V DC	RS232C	Pure black	Available	AIG12MQ12D
			Hairline silver	AIG12MQ13D		
GT12S	STN monochrome LCD (green/orange/red backlight)	24 V DC	RS232C	Pure black	Available	AIG12MQ14D
			Hairline silver	AIG12MQ15D		
GT12T	STN monochrome LCD (green/orange/red backlight)	24 V DC	RS232C	Pure black	Not available	AIG12GQ02D
			Hairline silver	AIG12GQ03D		
GT12U	STN monochrome LCD (green/orange/red backlight)	24 V DC	RS232C	Pure black	Not available	AIG12GQ04D
			Hairline silver	AIG12GQ05D		
GT12V	STN monochrome LCD (green/orange/red backlight)	24 V DC	RS232C	Pure black	Available	AIG12GQ12D
			Hairline silver	AIG12GQ13D		
GT12W	STN monochrome LCD (green/orange/red backlight)	24 V DC	RS232C	Pure black	Available	AIG12GQ14D
			Hairline silver	AIG12GQ15D		
GT32M	STN monochrome LCD	24 V DC	RS232C	Pure black	Available	AIG32MQ02D
			Hairline silver	AIG32MQ03D		
GT32T	TFT color LCD	24 V DC	RS232C	Pure black	Available	AIG32TQ02D
			Hairline silver	AIG32TQ03D		
GT32U	TFT color LCD	24 V DC	RS232C	Pure black	Available	AIG32TQ04D
			Hairline silver	AIG32TQ05D		
GT32V	TFT color LCD	24 V DC	RS232C	Pure black	Available	AIG32TQ12D
			Hairline silver	AIG32TQ13D		
GT32W	TFT color LCD	24 V DC	RS232C	Pure black	Available	AIG32TQ14D
			Hairline silver	AIG32TQ15D		

# FP2SH System Configurations and Unit Lineup

## Unit combinations

- Each unit is counted in the number of modules occupied. Most of the units occupy one module each. Some units occupy two modules each.
- Each unit is mounted on a backplane chosen depending on the total number of modules occupied by the all units used. The power supply unit and CPU unit must be mounted on the CPU backplane.
- Only one backplane other than the 5-module type can be added by using an expansion cable. Also, the 5-module type can not be used with expansion backplane. A power supply unit must be mounted on the expansion backplane.
- If the backplane is of the H type, up to three backplanes can be added.
- Most of the units can be used in any combination; however, some combinations are subject to constraints due to the unit type, current consumption, and other factors besides the above requirements. Please contact us for details.



**FP2SH** Power supply units



100 V AC  
2.5 A type  
**AFP2631**  
(FP2-PSA1)



200 V AC  
2.5 A type  
**AFP2632**  
(FP2-PSA2)



100 to 240 V AC  
5 A type  
**AFP2633**  
(FP2-PSA3)



24 V DC  
5 A type  
**AFP2634**  
(FP2-PSD2)

**FP2SH** Conventional type and H type backplanes

(For use with both master and expansion backplanes. Only the 5-module type can not be used with expansion backplane.)



5-module type  
**AFP25005** (FP2-BP05)



7-module type  
**AFP25007** (FP2-BP07)



9-module type  
**AFP25009** (FP2-BP09)



12-module type  
**AFP25012** (FP2-BP12)



14-module type  
**AFP25014** (FP2-BP14)



H type master backplanes  
(11 modules): 8 slots  
**AFP25011MH** (FP2-BP11MH)



H type expansion backplanes  
(10 modules): 8 slots  
**AFP25010EH** (FP2-BP10EH)

■ **Units that occupy two modules**  
There is a two-module type in the power supply units.

Type	Product No.
Power supply unit, 5 A type	<b>FP2-PSA3</b>
	<b>FP2-PSD2</b>

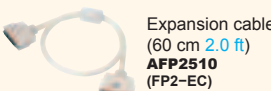

Expansion cable  
(60 cm 2.0 ft)  
**AFP2510**  
(FP2-EC)

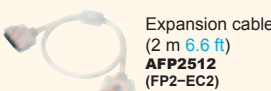

Expansion cable  
(2 m 6.6 ft)  
**AFP2512**  
(FP2-EC2)



Dummy unit  
**AFP2300**  
(FP2-DM)

**FP2SH** CPU units



32 k steps  
Standard type  
**AFP2221**  
(FP2-C2L)



60 k steps  
Standard type  
**AFP2231**  
(FP2-C2)



60 k steps  
For small PC card  
**AFP2235**  
(FP2-C2P)



120 k steps  
For small PC card  
**AFP2255**  
(FP2-C3P)

14

**FP2SH** I/O units, Positioning units and Network-related units

**I/O units**



16 points DC input  
**AFP23023** (FP2-X16D2)  
16 points NPN transistor output  
**AFP23403** (FP2-Y16T)  
16 points PNP transistor output  
**AFP23503** (FP2-Y16P)  
6 points Relay output  
**AFP23101** (FP2-Y6R)  
16 points Relay output  
**AFP23103** (FP2-Y16R)



32 points DC input  
**AFP23064** (FP2-X32D2)  
32 points NPN transistor output  
**AFP23404** (FP2-Y32T)  
32 points PNP transistor output  
**AFP23504** (FP2-Y32P)



64 points DC input  
**AFP23067** (FP2-X64D2)  
64 points NPN transistor output  
**AFP23407** (FP2-Y64T)  
64 points PNP transistor output  
**AFP23507** (FP2-Y64P)  
32 points input / 32 points NPN output mixed  
**AFP23467** (FP2-XY64D2T)  
**AFP23477** (FP2-XY64D7T)  
32 points input / 32 points PNP output mixed  
**AFP23567** (FP2-XY64D2P)  
**AFP23577** (FP2-XY64D7P)

**Analog I/O units**



Voltage / Current input  
**AFP2400L**  
(FP2-AD8VI)



Multiple analog input  
**AFP2401**  
(FP2-AD8X)



R.T.D. input  
**AFP2402**  
(FP2-RTD)



Analog output  
**AFP2410**  
(FP2-DA4)

**Positioning units RTEX**



(2 axes) **AFP243610**  
(FP2-PN2AN)  
(4 axes) **AFP243620**  
(FP2-PN4AN)  
(8 axes) **AFP243630**  
(FP2-PN8AN)

**Positioning units interpolation type**



(2 axes) **AFP243710**  
(FP2-PP2T)  
**AFP243711**  
(FP2-PP2L)  
(4 axes) **AFP243720**  
(FP2-PP4T)  
**AFP243721**  
(FP2-PP4L)

**Positioning units**



(2 axes)  
**AFP2432** (FP2-PP21) **AFP2434** (FP2-PP22)



(4 axes)  
**AFP2433** (FP2-PP41) **AFP2435** (FP2-PP42)

**Pulse I/O units**



High-speed counter  
**AFP2441** (FP2-HSCT) **AFP2451** (FP2-HSCP)



Pulse I/O  
**AFP2442** (FP2-PXYT) **AFP2452** (FP2-PXYP)

**Multi-communication unit**



Multi-communication  
**AFP2465** (FP2-MCU)  
\* The communication blocks are available separately.

**Compatible with open network FP2 FNS unit**



**AFP27930** (FP2-FNS)  
\* Communication block is not included.

- PROFIBUS DP block **AFPN-AB6200**
- DeviceNet block **AFPN-AB6201**
- CANopen block **AFPN-AB6218**

**Compatible with open network FP2 FMU units**



**AFP27972**

**Link-related units**



Multi-wire link  
**AFP2720** (FP2-MW)



Remote I/O slave unit  
**AFP2745** (FP2-RMS)

**Link-related units**



VE2-LINK  
**AFP279601** (FP2-VE2)



ET-LAN2  
**AFP27901** (FP2-ET2)



S-LINK  
**AFP2780** (FP2-SL2)



S-LINK V  
**SL-VFP2**

**FP2SH** AC servomotor MINAS Series



\* Panasonic Corporation Appliances Company Motor business unit

**FP2SH** Motor driver I/F terminal II



**AFP8503**  
1-axis type



**AFP8504**  
2-axis type

**FP2SH** Optional memories

FP memory loader



Expansion memory unit  
**AFP2208**



IC memory card (2 MB)  
**AFP2209**

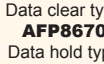

Data clear type  
**AFP8670**



Data hold type  
**AFP8671**

# Programming

## Control FPCWIN Pro (IEC61131-3 compliant Windows version software)

Compliant with international standard IEC61131-3 -- Programming software approved by PLCopen

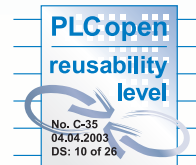
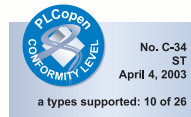
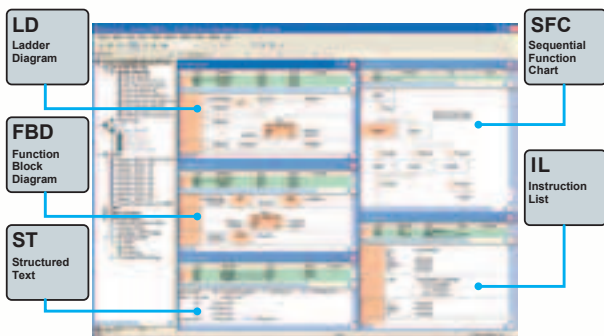

### Five programming languages can be used.

Programming can be done using the language most familiar to the developer or using the language most suited to the process to be performed. High-level (structured text) languages that allow structuring, such as C, are supported.

### Easy to reuse well-proven programs

Efficiency when writing programs has been greatly increased by being able to split programming up for each function and process using structured programming.

### Keep know-how from getting out

By "black boxing" a part of a program, you can prevent know-how from leaking out and improve the program's maintainability.

### Source program from PLC can be uploaded.

Serviceability is improved by being able to read programs and comments from a PLC. Programming for all models in the FP series possible.

\* This only applies to FP-X, FPZ, FP2 (with comment memory), FP2SH and FP10SH (with card board).

### Programming for all models in the FP series possible.

Any model can be used.

### [Programming in the most suitable language]

#### Programming in the language most suited to the process

Easy-to-understand, efficient programs can be created, for example, by using a ladder program for machine control or ST for communications control.

#### Programming in the language you are good at

Programming time can be greatly reduced by the easy ability to split and then integrate programming for each function and process.

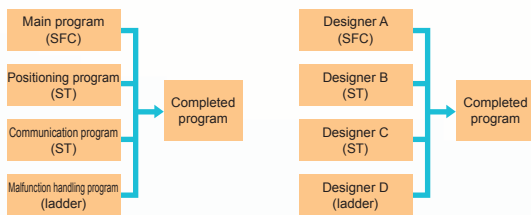

### ["Black boxing" of programs]

#### Multiple passwords for protection of each block

The security level (8 levels) can be input for each block in a program. Only users of a set security level or higher can make changes.

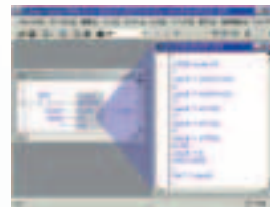
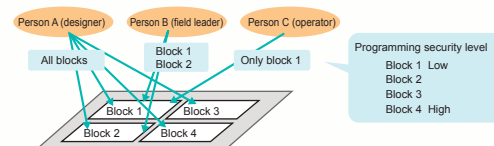

### [Reuse of programs is easy.]

Register well-proven programs by block in the library.

By using variable identifiers (names), there is no need to be concerned with addresses for each model when reusing programs.

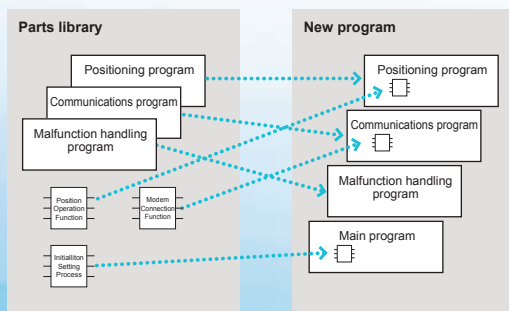

### [Operational environment]

OS	Windows 2000 / XP / Vista / 7*1
Hard disk capacity	At least 120 MB
CPU	Pentium III 700 MHz or higher
Onboard memory	At least 256 MB (depends on OS)
Screen resolution	At least 1,024 × 768
Display colors	High Color (16-bit) or higher
Applicable PLC	FPZ / FP-X / FP-e / FP0 / FP0R / FP1 / FP-M / FP2 / FP2SH / FP3 / FP10SH

Note: Production of FP1, FP-M, FP3, and FP10SH was discontinued in August 2006, and they are no longer sold.

\*1 Windows 7 is supported from Ver. 6.2.



## ■ Control FPWIN GR (for Windows version software)

The ladder programming software for FP series -- highly operational software tool for maximizing convenience in the field

- Easy field operations not requiring the use of a mouse for data entry, search, writing, monitoring and timer changes, all carried out only from the keyboard.
- All FP series PLCs are supported. The software assets produced by using Ver. 4 or Ver. 3 of NPST-GR are usable.
- Easy programming with wizard functions.
- Communication with GTWIN, PCWAY simultaneously through the same port.
- A simulation function is available.

### [Operational environment]

OS	Windows 98 / Me / 2000 / XP / Vista / 7*1
Hard disk capacity	At least 40 MB
CPU	Pentium 100 MHz or higher
Onboard memory	At least 64 MB (depends on OS)
Screen resolution	At least 1,024 × 768
Display colors	High Color (16-bit) or higher
Applicable PLC	FP0R / FP0 / FPε / FP-X / FP-e / FP1 / FP-M / FP2 / FP2SH / FP3 / FP10SH

Note: Production of FP1, FP-M, FP3, and FP10SH was discontinued in August 2006, and they are no longer sold.

\*1 Windows 7 is supported from Ver. 2.90.

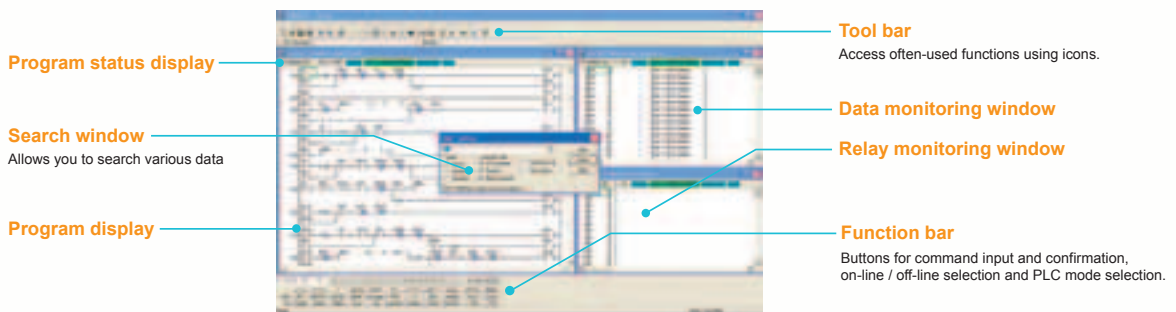

### Function instruction list



Classified by type, function instructions can be selected from the displayed list. (Simple help included.)

### I/O comment edit function

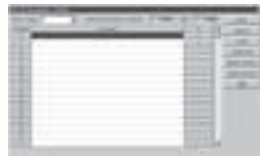

Successive I/O comments can be input for each device type. Data from Excel and other applications can be copied and pasted via the clipboard.

### Status display

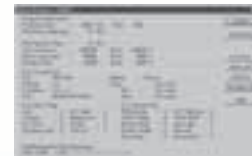

Displays information concerning PLC usage situation and settings, and detailed information when an error occurs.

### Text compiler



This software is for importing and exporting programs created in text format to and from FPWIN GR. Programs created on the PLC of another company can be edited as text and then be transferred to the FP Series without difficulty.

### Text command input mode

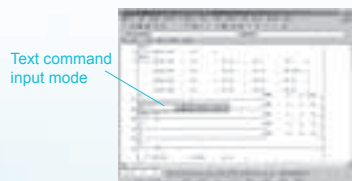

Text command input mode

A ladder diagram is displayed as a mnemonic code is entered from the keyboard.

## ■ Accompanying Tools

### Data Editor

This software for the PC is for reading and writing data stored in the memory of FP Series main unit or on an IC card. If a large data table is required in a PLC, the data can be created and edited on a PC and then download to the PLC.

### Modem connection

Communication via modem is easy with FP Series units in isolated locations.

### Wizard function

A Wizard function included in FPWIN GR since versions 2.2 can automatically generate ladder programs by simply entering and selecting required items in the dedicated screen. It can be used to assist in positioning, PID instruction input, and FP-e screen display instruction input.

### Personal preference settings

It is possible to switch among preference settings for FPWIN GR, Data Editor and Text Compiler that are set up for different individuals.

# List of Unit Specifications ①

## CPU units

Item	FP2SH CPU unit				
	Product No. (Part No.)	FP2-C2L (AFP2221)	FP2-C2 (AFP2231)	FP2-C2P (AFP2235)	FP2-C3P (AFP2255)
Operation speed	for Basic instruction	From 0.03 μs			
	for High-level instruction	From 0.06 μs			
Program capacity	Built-in RAM	32 k steps		60 k steps	120 k steps
	When expanded	Not available			
Number of controllable I/O points	No expansion	Conventional type	Max. 768 points		
		H type	Max. 512 points		
	When expanded	Conventional type	Max. 1,600 points		
		H type	Max. 2,048 points		
When using remote I/O system	Max. 8,192 points				
Operation memory	Internal relay	14,192 points			
	Data register	10,240 words			
	File register	32,765 words	32,765 words x 3 banks		
	Link register	8,448 words			
Optional memory	F-ROM/EP-ROM			Small PC card (F-ROM/S-RAM)	
Comment memory	Built-in				
Calendar timer	Built-in				

## Power supply units

Product No. (Part No.)		FP2-PSA1 (AFP2631)	FP2-PSA2 (AFP2632)	FP2-PSA3 (AFP2633)	FP2-PSD2 (AFP2634)
Input	Rated voltage	100 V to 120 V AC	200 V to 240 V AC	100 V to 240 V AC	24 V DC
	Current consumption	0.4 A or less (at 100 V AC)	0.2 A or less (at 200 V AC)	0.7 A or less (at 100 V AC) 0.4 A or less (at 200 V AC)	2.5 A or less
	Surge current	40 A or less (at 55°C 131 °F)		30 A or less (at 25°C 77 °F)	10 A or less
	Frequency	47 Hz to 63 Hz			
	Voltage fluctuation range	85 to 132 V AC	170 to 264 V AC	85 to 264 V AC	20.4 to 31.2 V DC*
Output	Output capacity at 5 V	Max. 2.5 A		Max. 5 A	
Alarm contact capacity		1 A 30 V DC			
Alarm contact operation		When the ALARM LED of CPU unit is lit			
Alarm contact type		1 Form C contact			
Leakage current		Between input and ground terminals, 0.75 mA or less			
Breakdown voltage		1,500V AC for 1 minute (between input and ground terminals)			
Insulation resistance		100 MΩ 500 V DC (between input and ground terminals)			
Guaranteed lifetime		20,000 hours at 55°C 131 °F			
Overcurrent protection function		Built-in overcurrent protection			
Fuse		Built-in			
Terminal screw		M3			
Module size		1 module	1 module	2 modules	2 modules

Note: Allowable voltage fluctuation range after startup for the FP2-PSD2 is -35 % to +30 %. At startup, apply -15 % to +30 % the rated voltage for 100 ms or more.

## Input units

Item	DC input units			I/O mixed units (input side)	
	16-point type	32-point type	64-point type	<sup>(Note 1)</sup> DC input type/Transistor output (NPN) type	<sup>(Note 2)</sup> DC input type/Transistor output (PNP) type
	FP2-X16D2 (AFP23023)	FP2-X32D2 (AFP23064)	FP2-X64D2 (AFP23067)	FP2-XY64D2T (AFP23467)	FP2-XY64D2P (AFP23567)
Rated input voltage	12 to 24 V DC	24 V DC	24 V DC	24 V DC	24 V DC
Rated input current	8 mA approx. (at 24V DC)	4.3 mA approx. (at 24V DC)	4.3 mA approx. (at 24V DC)	4.3 mA approx. (at 24V DC)	4.3 mA approx. (at 24V DC)
Impedance	3 kΩ approx.	5.6 kΩ approx.	5.6 kΩ approx.	5.6 kΩ approx.	5.6 kΩ approx.
Min. ON voltage/Min. ON current	9.6 V/4 mA	19.2 V/4 mA	19.2 V/4 mA	19.2 V/4 mA	19.2 V/4 mA
Max. OFF voltage/Max. OFF current	2.5 V/1 mA	5.0 V/1.5 mA	5.0 V/1.5 mA	5.0 V/1.5 mA	5.0 V/1.5 mA
Response time	OFF→ON	0.2 ms or less	0.2 ms or less	0.2 ms or less	0.2 ms or less
	ON→OFF	0.2 ms or less	0.3 ms or less	0.3 ms or less	0.3 ms or less
Input points per common	8 points/common (Either the positive or negative of the input power supply can be connected to the common terminal.)	32 points/common	32 points/common	32 points/common	32 points/common
Connection method	Terminal block (M3 screw)	Connector (one 40-pin)	Connector (two 40-pin)	Connector (two 40-pin)	Connector (two 40-pin)

Notes: The number of ON points that can be actuated simultaneously is limited by the input voltage and the ambient temperature.  
 1) The specifications also apply to the DC input, transistor output (NPN) type I/O mixed unit with ON pulse catch input FP2-XY64D7T (AFP23477).  
 However, the response time is as follows: OFF→ON: 0.2 ms or less (X0 to X1F); ON→OFF: 0.3 ms or less (X0 to X1B), 1.0 to 5.0 ms (X1C to X1F)  
 2) The specifications also apply to the DC input, transistor output (PNP) type I/O mixed unit with ON pulse catch input FP2-XY64D7P (AFP23577).  
 However, the response time is as follows: OFF→ON: 0.2 ms or less (X0 to X1F); ON→OFF: 0.3 ms or less (X0 to X1B), 1.0 to 5.0 ms (X1C to X1F)

## Output units

Item	Relay output units				Transistor output units				I/O mixed units (output side) (Note 3, 4)	
	6-point type (Note 1)	16-point type	NPN open collector 16-point type (Note 2)	PNP open collector 16-point type (Note 2)	NPN open collector	PNP open collector	NPN open collector	PNP open collector	DC input type/Transistor output (NPN) type	DC input type/Transistor output (PNP) type
	FP2-Y6R (AFP23101)	FP2-Y16R (AFP23103)	FP2-Y16T (AFP23403)	FP2-Y16P (AFP23503)	FP2-Y32T (AFP23404)	FP2-Y32P (AFP23504)	FP2-Y64T (AFP23407)	FP2-Y64P (AFP23507)	FP2-XY64D2T (AFP23467)	FP2-XY64D2P (AFP23567)
Rated control capacity	5 A 250 V AC (10 A/common) 5 A 30 V DC (10 A/common) Min. load: 100 mA 10 V (resistor load)	2 A 250 V AC (5 A/common) 2 A 30 V DC (5 A/common) Min. load: 100 mA 100 mV (resistor load)	-	-	-	-	-	-	-	-
Rated load voltage	-	-	5 to 24 V DC	5 to 24 V DC	5 to 24 V DC	5 to 24 V DC	5 to 24 V DC	5 to 24 V DC	5 to 24 V DC	5 to 24 V DC
Max. load current	-	-	0.5 A (at 12 to 24 V DC) 0.1 A (at 5 V DC)	0.5 A (at 12 to 24 V DC) 0.1 A (at 5 V DC)	0.1 A (at 12 to 24 V DC) 50 mA (at 5 V DC)	0.1 A (at 12 to 24 V DC) 50 mA (at 5 V DC)	0.1 A (at 12 to 24 V DC) 50 mA (at 5 V DC)	0.1 A (at 12 to 24 V DC) 50 mA (at 5 V DC)	0.1 A (at 12 to 24 V DC) 50 mA (at 5 V DC)	0.1 A (at 12 to 24 V DC) 50 mA (at 5 V DC)
Max. surge current	-	-	3 A 10 ms or less	3 A 10 ms or less	0.3 A	0.3 A	0.3 A	0.3 A	0.3 A	0.3 A
OFF state leakage current	-	-	1 µA or less	1 µA or less	1 µA or less	1 µA or less	1 µA or less	1 µA or less	1 µA or less	1 µA or less
ON state maximum voltage drop	-	-	0.5 V or less	0.5 V or less	1 V or less (at 6 to 26.4 V DC) 0.5 V or less (at 6 V DC or less)	1.5 V or less (at 6 to 26.4 V DC) 0.5 V or less (at 6 V DC or less)	1 V or less (at 6 to 26.4 V DC) 0.5 V or less (at 6 V DC or less)	1.5 V or less (at 6 to 26.4 V DC) 0.5 V or less (at 6 V DC or less)	1 V or less (at 6 to 26.4 V DC) 0.5 V or less (at 6 V DC or less)	1.5 V or less (at 6 to 26.4 V DC) 0.5 V or less (at 6 V DC or less)
Repose time	OFF→ON	10 ms or less	10 ms or less	0.1 ms or less	0.1 ms or less	0.1 ms or less	0.1 ms or less	0.1 ms or less	0.1 ms or less	0.1 ms or less
	ON→OFF	8 ms or less	8 ms or less	0.3 ms or less	0.3 ms or less	0.3 ms or less	0.3 ms or less	0.3 ms or less	0.3 ms or less	0.3 ms or less
Power supply for driving internal circuit	Voltage	24 V DC ±10% (21.6 V to 26.4 V DC)	24 V DC ±10% (21.6 V to 26.4 V DC)	4.75 to 26.4 V DC	4.75 to 26.4 V DC	4.75 to 26.4 V DC	4.75 to 26.4 V DC	4.75 to 26.4 V DC	4.75 to 26.4 V DC	4.75 to 26.4 V DC
	Current	70 mA or less	160 mA or less	120 mA or less (at 24 V DC)	70 mA or less (at 24 V DC)	140 mA or less (at 24 V DC)	150 mA or less (at 24 V DC)	250 mA or less (at 24 V DC)	270 mA or less (at 24 V DC)	120 mA or less (at 24 V DC)
Input points per common	2 points/common	8 points/common	8 points/common	8 points/common	32 points/common	32 points/common	32 points/common	32 points/common	32 points/common	32 points/common
Connection method	Terminal block (M3 screw)	Terminal block (M3 screw)	Terminal block (M3 screw)	Terminal block (M3 screw)	Connector (one 40-pin)	Connector (one 40-pin)	Connector (two 40-pin)	Connector (two 40-pin)	Connector (two 40-pin)	Connector (two 40-pin)

Notes: • The number of ON points that can be actuated simultaneously is limited by the input voltage and the ambient temperature. • The load current is limited by the external power supply voltage.  
 1) The current capacity of each common terminal is 5 A or less. 2) The maximum load current of the transistor output unit is limited by the external power supply voltage.  
 3) The specifications also apply to the DC input, transistor output (NPN) type I/O mixed unit with ON pulse catch input FP2-XY64D7T (AFP23477).  
 4) The specifications also apply to the DC input, transistor output (PNP) type I/O mixed unit with ON pulse catch input FP2-XY64D7P (AFP23577).

## Analog I/O units

### Analog input

Item	FP2-AD8X (AFP2401)	FP2-RTD (AFP2402)	FP2-AD8VI (AFP2400L)
Number of input points	8 channels	8 channels	8 channels
Voltage	±10 V (1/65,536)	-	±10 V (1/65,536)
	1 V to 5 V (1/13,107)	-	1 V to 5 V (1/13,107)
Current	±100 mV (1/65,536)	-	-
	- (Note)	-	±20 mA (1/32,768) 4 mA to 20 mA (1/13,107)
Input range (resolution)	Thermocouple	-	S: 0 to +1,500 °C 32 to +2,732 °F (0.1 °C 32.18 °F)
			J: -200 to +750 °C -328 to +1,382 °F (0.1 °C 32.18 °F)
			J: -100 to +400 °C -148 to +752 °F (0.1 °C 32.18 °F)
			K: -200 to +1,200 °C -328 to +2,192 °F (0.1 °C 32.18 °F)
			K: -200 to +1,000 °C -328 to +1,832 °F (0.1 °C 32.18 °F)
			K: -200 to +600 °C -328 to +1,112 °F (0.1 °C 32.18 °F)
			T: -200 to +350 °C -328 to +662 °F (0.1 °C 32.18 °F)
			R: 0 to +1,500 °C 32 to +2,732 °F (0.1 °C 32.18 °F)
	N: -200 to +1,300 °C -328 to +2,372 °F (0.1 °C 32.18 °F)		
	R.T.D.	Pt100: -200 to +650 °C -328 to +1,202 °F (0.1 °C 32.18 °F)	
Pt100: -100 to +200 °C -148 to +392 °F (0.1 °C 32.18 °F)			
JPt100: -200 to +650 °C -328 to +1,202 °F (0.1 °C 32.18 °F)			
JPt100: -100 to +200 °C -148 to +392 °F (0.1 °C 32.18 °F)			
JPt1000: -100 to +100 °C -148 to +212 °F (0.1 °C 32.18 °F)			
Conversion speed	Voltage	500 µs/ch (not insulated), 5 ms (insulated)	500 µs/ch
	Current	-	500 µs/ch
	Thermocouple	20 ms/ch	-
	R.T.D.	20 ms/ch	-
Overall accuracy	Voltage: ±0.1 % FS (25 °C 77 °F), Voltage and temperature: ±0.3 % (0 to 55 °C 32 to 131 °F)	±0.3 % F.S. (0 to 55 °C 32 to 131 °F)	±0.3 % F.S. (0 to 55 °C 32 to 131 °F)
Insulation method	Between the input terminal and FP2 internal circuits: Photocoupler and DC/DC converter		
	Between channels: PhotoMOS relay	-	-
Digital output	Averaging	Selectable from 3 to 64 times for each channel (Moving average after cutting the maximum and minimum values)	
	Offset setting	Selectable from K -2048 to K +2047 for each channel	
Broken wire sensing	Each channel (only when a thermocouple or R.T.D. is inputted)	Each channel	-
Input range change method	By the range setting switch: Batch switching of all channels		
	By shared memory setting: Each channels		

Note: Current inputs can be converted into voltage inputs by attaching the supplied external resistor to the input terminal section.

### Analog output

Item	Analog output unit FP2-DA4 (AFP2410)	
Number of output points	4 channels	
Output range (digital input)	Voltage	±10 V (K-2048 to K+2047)
	Current	0 to 20 mA (K0 to K4095)
Resolution	1/4,096	
Conversion speed	500 ms/ch	
Overall accuracy	±1.0 % F.S. or less (0 to 55 °C 32 to 131 °F)	
Insulation method	- Between the analog output terminal and FP2 internal circuits: Photocoupler - Between analog output channels: Not insulated	
Analog output	Hold/Non-hold setting by shared memory setting	

# List of Unit Specifications ②

## ET-LAN2 unit (AFP27901)

### Performance specification

Item	Specifications
Communications function	- MEWTOCOL-COM: computer link function (Max. 2 kB) - MEWTOCOL-DAT: data transfer (Max. 1,020 words) - Transparent communication
Number of communication connections	Max. 8 connections
Transparent communications buffer	Transmit: Factory setting: (1k words/connection) x 3
	Receive: Factory setting: (1k words/connection) x 3

### Transmission specifications for communication interface

Item	100BASE-TX (Note 1)	10BASE-T (Note 1)
Transmission speed	100 Mbit/s	10 Mbit/s
Transmission method	Base band	Base band
Max. segment length	100 m <b>328 ft</b> (Note 2)	100 m <b>328 ft</b> (Note 2)
Max. distance between nodes	205 m <b>673 ft</b> (2 segments)	500 m <b>1,640 ft</b> (5 segments)
Communication cable of connection	UTP (Category 5)	UTP (Category 3, 4 and 5)

Notes: 1) Switching between 100BASE-TX and 10BASE-T is done automatically by auto negotiation function.  
2) The standards cite 100 m **328 ft** as the maximum, but noise resistance measures such as attaching a ferrite core may be necessary in some cases, depending on the usage environment. Also, if the hub is positioned close to a control board, we recommend using it at a distance of 10 m **32.8 ft** or less.

## MEWNET-VE2 link unit (AFP279601)

Item	VE mode (PLC link)	FL-net mode
	Communication interface	Ethernet 10BASE-T
Communication speed	10 Mbit/s	
Cycle time example	50 ms/32 units (2,048 points/2,048 words)	
Cable length	10BASE-T : 100 m <b>328 ft</b> (500 m <b>1,640 ft</b> ) *The lengths in parentheses are available when a repeater is used.	
Communication protocol	MEWTOCOL	FL-net [FA link protocol (UDP/IP)]
Link communication specifications	Link relay 8,192 points/unit Link register 8,192 words/unit	
Message communication specifications	Max. 2,048 bytes (Compatible with MEWTOCOL)	Max. 1,024 bytes (Not compatible with MEWTOCOL)
Number of nodes	Max. 99 units	Max. 254 units
Other functions	Computer link Data transfer Remote programming Multilevel link communications	Interconnection with other companies' units

## Multi-communication unit (AFP2465)

○: Available  
✕: Not available

Item	General-purpose serial communications		Computer link (Note 1) (Open protocol "MEWTOCOL" should be used.)		PLC link function (MEWNET-W0)
	1:1 communications	1:N communications	1:1 communications	1:N communications	
Communication block used	<b>AFP2803</b> <b>AFP2804</b>	<b>AFP2805</b>	<b>AFP2803</b> <b>AFP2804</b>	<b>AFP2805</b>	<b>AFP2803</b> <b>AFP2805</b>
Interface	RS232C RS422	RS485	RS232C RS422	RS485	RS232C RS485
Communication method	Full duplex	Two-wire half duplex	Full duplex	Two-wire half duplex	Token bus (Floating master)
Synchronous method	Start-stop synchronization				
Transmission cable	Three-core or five-core shielded wire	Twisted-pair cable or VCTF	Three-core or five-core shielded wire	Twisted-pair cable or VCTF	Twisted-pair cable or VCTF
Transmission distance	15 m <b>49.2 ft</b> Max. 1,200 m <b>3,937 ft</b>	Max. 1,200 m <b>3,937 ft</b>	15 m <b>49.2 ft</b> Max. 1,200 m <b>3,937 ft</b>	Max. 1,200 m <b>3,937 ft</b>	1,200 m <b>3,937 ft</b> (RS485) 15 m <b>49.2 ft</b> (RS232C)
Transmission speed (To be set in the system register)	300 to 230,400 bps	300 to 230,400 bps (19,200 bps when our C-NET adapter is connected)	300 to 230,400 bps	300 to 230,400 bps (19,200 bps when our C-NET adapter is connected)	115,200 bps
Transmission code	ASCII, JIS7, JIS8 and Binary		ASCII, JIS7 and JIS8		-
Transmission format (To be set in the system register)	Data length: 7 bits/8 bits				
	Parity: 0/Invalid/Valid (Odd/Even)				
	Stop bit: 1 bit/2 bits				
	Start code: with STX / without STX		-		-
End code: CR/CR + LF/Time setting/ETX		-		-	
Number of stations	-	Max. 99 stations (Max. 32 stations when our C-NET adapter is connected)	-	Max. 99 stations (Max. 32 stations when our C-NET adapter is connected)	Max. 16 stations
PLC link capacity	-	-	-	-	Link relay: 1,024 points Link register: 128 words
COM1 (upper channel)	○	○	○	○	○
COM2 (lower channel)	○	○	○	○	✕
Number of attachable units	Max. 23 units (including 8 units for the computer link and 2 channels for the PLC link)				
Supported versions	CPU unit: Ver. 1.4 or later, FPWIN-GR: Ver. 2.4 or later, FPWIN-PRO: Ver. 5.1 or later				

Note: 1) The protocol can be downloaded from: <http://www.panasonic.net/id/pidx/global>

## Multi-wire link unit

Item	FP2-MW (AFP2720)		
	W mode	W2 mode	F mode
Communication method	Token bus		Polling
Transmission method	Base band		
Transmission speed	500 kbit/s	500 kbit/s, 250 kbit/s	500 kbit/s
Transmission distance	Extendable to 800 m <b>2,625 ft</b>	Extendable to 800 m <b>2,625 ft</b> 250 kbit/s: 1,200 m <b>3,937 ft</b> 500 kbit/s: 800 m <b>2,625 ft</b>	Extendable to 700 m <b>2,297 ft</b>
Number of connectable stations	Max. 32 stations		1 master + Max. 32 slave stations
Transmission error check	CRC (Cyclic Redundancy Check) system		
Synchronous method	Start-stop synchronization		
Interface	RS485 compatible		
Transmission cable	Twisted-pair cable		Twisted-pair cable or VCTF cable
RAS function	Hardware self-diagnosis function		

Note: When the unit is used in W2 mode, it must be set by user programs.

## S-LINK unit

Item	S-LINK unit FP2-SL2 (AFP2780)
	Number of channels
Number of I/O points	Max. 128 points The number of input and output points for each channel can be selected by the switch in the unit body. Input: 0, 32, 64, 96 or 128 points Output: 0, 32, 64, 96 or 128 points
Rated power supply voltage	+24 V DC ±10 % Allowable ripples P-P: ±10 % or less (S-LINK terminal block IN-24 V, 1.6 A DC or less)
Power consumption (Note 1)	[Current consumption of the S-LINK controller (incl. D-G line current consumption)] +24 V DC 1.6 A or less [Maximum allowable current supply (Supply to the S-LINK and I/O devices through the 24 V - 0 V line)] +24 V DC 5 A (Fuse: 5A or less)
Transmission method	Bi-directional time division multiplex transmission
Synchronous method	Bit synchronization and Frame synchronization
Transmission protocol	S-LINK protocol
Transmission speed	28.5 kbit/s
Transmission distance (Note 2)	Main signal line: Extendable to 200 m <b>656 ft</b> (max. 400 m <b>1,312 ft</b> when a booster is used)
FAN-OUT (Note 2)	320
Connection method	T-branch multi-drop wiring or standard multi-drop wiring [+24, 0 V, D-G (with a function of D-G short-circuit protection)]

Notes: 1) Refer to the "Power Capacity Determination" section of S-LINK Design Manual for details of the current consumption.  
2) Refer to S-LINK Design Manual for the booster and FAN-OUT.



# List of Unit Specifications ③

## Positioning units RTEX (Network type)

Item	2 axes type	4 axes type	8 axes type
Part No.	AFP243610	AFP243620	AFP243630
Product No.	FP2-PN2AN	FP2-PN4AN	FP2-PN8AN
Number of axes controlled	2 axes (2 axes x 1 system)	4 axes (4 axes x 1 system)	8 axes (8 axes x 1 system)
Position control function	Control method	PTP control, Continuous Path (CP) control	
	Interpolation control	Two/Three axis linear interpolation, two axis circular interpolation, three axis spiral interpolation	
	Unit of control	pulse / mm / inch / degree	
	Positioning data	650 points per axis (Standard area: 600 points, Expansion area: 25 points)	
	Backup	Parameters and data tables can be saved in FROM.	
	Acceleration/deceleration method	Linear/S-curve acceleration and deceleration	
	Acceleration/deceleration time	0 to 10,000 ms (in increments of 1 ms)	
Positioning range	(-1,073,741,823 to +1,073,741,823 pulses) Increment/Absolute specification		
Speed control function	Supported by a JOG operation (free-run operation)		
Torque control function	Supported by a real-time torque control function		
Home return	Search method Home proximity (DOG) search		
Others	Creep rate Can be set freely		
	Pulsar input operation supported		
	Auxiliary output code and auxiliary output contact Dwell time supported In-position contact monitoring available		
Communication speed	100 Mbps		
Cables	Commercially-available LAN straight cable (Shielded type cable Category 5e)		
Connection system	Ring method		
Communication cycle/ Number of connectable stations	0.5 ms, up to 8 axes/system (Command cycle: 1 ms)		
Transmission distance	Between stations: 60 m 197 ft Extendable total length: 200 m 656 ft		

## Positioning units Multifunction type (Pulse output type)

Part No.	AFP2432	AFP2433	AFP2434	AFP2435
Product No.	FP2-PP21	FP2-PP41	FP2-PP22	FP2-PP42
Output type	Transistor		Line driver	
Number of axes controlled	2 axes, independent	4 axes, independent	2 axes, independent	4 axes, independent
Position command	Command units Pulse (The program specifies whether Increment or Absolute is used.)			
Speed command	Max. pulse count Signed 32 bits (-2,147,483,648 to +2,147,483,647 pulses)			
Acceleration/deceleration command	Acceleration/deceleration	Linear acceleration/deceleration, S acceleration/deceleration (this takes the form of an "S")		
	'S' Acceleration/deceleration	Can select from Sin curve, Secondary curve, Cycloid curve and Third curve.		
Home return	Home return speed Speed setting possible (changes return speed and search speed)			
Operation mode	Input terminals Home input, Near home input, Over limit input (+), Over limit input (-)			
	Output terminals Deviation counter clear output signal			
Startup time	0.02 ms or 0.005 ms selecting possible			
High-speed counter	Countable range Signed 32 bits (-2,147,483,648 to +2,147,483,647 pulse)			
Other functions	Input mode 2-phase input*, Direction distinction input, Individual input (transfer multiple available for each.)			
	The flag to compare the elapsed value is built in. (The timing signal outputs at the optional position during an operation.)			
External power supply	Max. 200 mA	Max. 350 mA	Max. 200 mA	Max. 350 mA
Current consumption	50 mA	90 mA	50 mA	90 mA

\* Previous FP2 positioning units (AFP2430 and AFP2431) are not compatible with the Multi-function type FP2 positioning unit.  
\* 2-phase input cannot be used with multiples of one.

## Flexible Network Slave Units (FNS)

Item	PROFIBUS	DeviceNet	CANopen
Communication speed	9,600 bps to 12 Mbps Auto detection/Setting	125 kbps to 500 kbps Auto detection/Setting	10 kbps to 1 Mbps Auto detection/Setting
Communication data	Input / Output: 76 words (one unit average: 1 to 4 words)	Input: 128 words / Output: 128 words (at cyclic mode)	128 words (for TPDO and RPDO)
Connection type	Reading operation data as serial I/O data via the PROFIBUS network	• Cyclic connection • Change Of State (COS) • Bitstroupe connection • Polled connection • Explicit connection	• Synchronous cyclic method • Asynchronous cyclic method • COS method • Exchanging PDO (Process Data Object) using the timer operation connection method
Insulation	Galvanic insulation	Galvanic insulation	Galvanic insulation
Others	Self-diagnosis function equipped	• UCM • CPI parameter • Self-diagnosis function equipped	Self-diagnosis function equipped

## High-speed counter units and Pulse I/O units

Item	FP2 High-speed counter units	FP2 Pulse I/O units	
Part No.	AFP2441 (NPN) AFP2451 (PNP)	AFP2442 (NPN) AFP2452 (PNP)	
Input	Insulation method	Photocoupler insulation	
	Rated input voltage	24 V DC	
	Rated input current	7.5 mA approx. (when using 24 V DC)	
	Input impedance	3.2 kΩ approx.	
	Usage voltage range	20.4 V DC to 26.4 V DC	
	Min. ON voltage/Min. ON current	19.2 V/6 mA	
	Min. OFF voltage/Min. OFF current	5.0 V/1.5 mA	
Response time (Note 1)	OFF→ON	1 μs or less	
	ON→OFF	2 μs or less	
Input time constant setting	None, 4 μs, 8 μs, 16 μs, 32 μs (set in 2-input units)		
Common method	16 points/common		
Counter	Number of counter channels	4 channels	
	Countable range	Signed 32 bits (-2,147,483,648 to +2,147,483,647)	
	Max. countable speed (Note 1)	200 kHz	
	Input modes	3 modes (direction control, individual input, phase input)	
Interrupt	Min. input pulse width (Note 1)	2.5 μs	
	Other	8 comparison outputs, multiplier function (1, 2, 4)	
Output specifications	Number of interrupt points (Note 2)	None, 1 point/unit, 8 points/unit (set with mode setting switches)	
	Interrupt processing delays	50 μs or less (when using FP2SH CPU unit)	
	Insulation method	Photocoupler insulation	
	Rated load voltage	5 to 24 V DC	
	Rated load voltage range	4.75 V DC to 26.4 V DC	
	Max. load current	0.1 A (A11 to A18, B11 to B14 pins), 0.8 A (B15 to B18 pins)	
	Leakage current when OFF	1 μA or less	
	Max. voltage drop when ON	0.5 V or less	
	Response time	OFF→ON ON→OFF	1 μs or less NPN output type: 1 μs or less PNP output type: 5 μs or less
	Surge absorber	Zener diode	
Counter	Common method	16 points/common	
	External power supply	Voltage	20.4 V DC to 26.4 V DC
		Current (when using 24 V DC)	NPN output type: 90 mA or less PNP output type: 200 mA or less
	Comparison output	8 points (A11 to A18 pins)	
Pulse output	Channels	4 channels (B11 to B18 pins)	
	Max. output frequency	100 kHz	
PWM output	Output mode	2 modes (direction control, individual output)	
	Number of output points	4 channels (B15 to B18 pins)	
	Max. load current	0.8 A	
Duty (Note 3)	Cycle	1 Hz to 30 kHz	
	Duty	0 to 100 % (unit: 1 %)	

Notes:  
1) This value is effective when the input time constant (filter) setting was set to "No setting".  
2) If interrupts are used at the 1 point/unit setting, the interrupt from the external input terminal B1 (X8) or the interrupt program from the comparison 0 (one of among INT16 to INT23) is booted.  
3) At maximum load current and resistance load. There may be distortion in the output waveform, depending on the load current and type of load.

## Remote I/O Slave Unit (Common to MEWNET-F)

Item	Specifications	
Communication method	Two-wire half duplex	
Synchronous method	Start-stop synchronization	
Transmission distance	Extendable to 700 m 2,297 ft per port (at two cabling routes)	
Transmission speed	0.5 Mbps	
Transmission cable	2-wire cable (VCTF 0.75 mm <sup>2</sup> × 2C)	
Interface	Multidrop (RS485)	
Transmission error check	Cyclic Redundancy Check (CRC) method	
I/O control	Number of master units per CPU unit	Max. 4 units
	Connectable number of stations per master unit	Max. 32 stations
	Controllable number of points per master unit	Max. 4, 096 points
	Number of I/O points per each station	I/O Terminal Board
I/O Terminal Unit		Per unit used alone: 16 points When expanded: 32 points * The number of occupied points of the 8-point and 16-point units is identical. If the input and output are used in combination, the I/O numbers are assigned from the input points first, and the number of points is as follows: 16 input points and 16 output points.
Number of slots per CPU unit	Number of slots per master unit	Max. 128 slots Max. 64 slots
	FP2 Slave Unit System	Max. 24 slots
Number of slots per each station	I/O Terminal Board	1 slot
	I/O Terminal Unit	1 slot * There is only one slot even with the expanded configuration.
Units that can and cannot be connected to slave stations	Connectable unit	• I/O units • Serial Data Unit (SDU) • S-LINK Unit
	Not connectable unit	• Analog-related I/O units (A/D, D/A and RTD) • High-speed Counter Unit and Pulse I/O Unit (Connectable unless the interrupt function is used) • Link-related units (ET-LAN, VE, MW, FNS, MCU and CCU) • Positioning Unit Interpolation type • Positioning Unit Multi function type • Positioning Unit RTEX type

# Product types

## CPU units (Built-in RAM)

Product name		Operation speed	Built-in RAM	Optional memory			Other		Product No.	Part No.
				Expansion RAM	ROM	IC memory card	Calendar timer	Comment memory		
FP2SH	32 k Standard type	From 0.03 μs	32 k steps	Not available	Available (separately sales)	Not available	Available (built-in)	Available (built-in)	FP2-C2L	AFP2221
	60 k Standard type		60 k steps	Not available	Available (separately sales)	Not available	Available (built-in)	Available (built-in)	FP2-C2	AFP2231
	60 k type with IC memory card interface		60 k steps	Not available	Available (built-in)	Available (separately sales)	Available (built-in)	Available (built-in)	FP2-C2P	AFP2235
	120 k type with IC memory card interface		120 k steps	Not available	Available (built-in)	Available (separately sales)	Available (built-in)	Available (built-in)	FP2-C3P	AFP2255

## Optional memories

Product name	Specifications	Part No.
Expansion memory board	Memory board in which the nonvolatile memory was mounted beforehand	AFP2208
IC memory card (Small PC card) for FP2SH CPU unit with IC memory card interface SRAM	Perfect for data memory Can also be used for program backup. Battery backups.	AFP2209
FP Memory Loader	Data clear type	AFP8670
	Data hold type	AFP8671

## Backplanes

Product name	Specifications	Product No.	Part No.	
FP2 Backplane	Conventional type	5-module type (for master)	FP2-BP05	AFP25005
		7-module type (for master and expansion)	FP2-BP07	AFP25007
		9-module type (for master and expansion)	FP2-BP09	AFP25009
		12-module type (for master and expansion)	FP2-BP12	AFP25012
		14-module type (for master and expansion)	FP2-BP14	AFP25014
	H type	8 slots (for master)	FP2-BP11MH	AFP25011MH
FP2 Expansion Cable	8 slots (for expansion)	0.6 m 2.0 ft	FP2-EC	AFP2510
		2 m 6.6 ft	FP2-EC2	AFP2512

## Power supply units

Product name	Specifications	Product No.	Part No.
FP2 Power Supply Unit	Input: 100 to 120 V AC, Output: 2.5 A	FP2-PSA1	AFP2631
	Input: 200 to 240 V AC, Output: 2.5 A	FP2-PSA2	AFP2632
	Input: 100 to 240 V AC, Output: 5 A	FP2-PSA3	AFP2633
	Input: 24 V DC, Output: 5 A	FP2-PSD2	AFP2634

## I/O units

Product name	Type	Number of point	Connection method	Specifications	Product No.	Part No.
FP2 Input Unit	DC input	16 points	Terminal block	12 to 24 V DC	FP2-X16D2	AFP23023
		32 points	Connector	24 V DC	FP2-X32D2	AFP23064
		64 points	Connector	24 V DC	FP2-X64D2	AFP23067
FP2 Output Unit	Relay output	6 points	Terminal block	5 A, 2 points per one common	FP2-Y6R	AFP23101
		16 points	Terminal block	2 A, 8 points per one common	FP2-Y16R	AFP23103
	Transistor output NPN	16 points	Terminal block	0.5 A (12 to 24 V DC), 0.1 A (5 V DC)	FP2-Y16T	AFP23403
		32 points	Connector	0.1 A (12 to 24 V DC), 50 mA (5 V DC)	FP2-Y32T	AFP23404
		64 points	Connector	0.1 A (12 to 24 V DC), 50 mA (5 V DC)	FP2-Y64T	AFP23407
	Transistor output PNP	16 points	Terminal block	0.5 A (12 to 24 V DC), 0.1 A (5 V DC)	FP2-Y16P	AFP23503
		32 points	Connector	0.1 A (12 to 24 V DC), 50 mA (5 V DC)	FP2-Y32P	AFP23504
		64 points	Connector	0.1 A (12 to 24 V DC), 50 mA (5 V DC)	FP2-Y64P	AFP23507
FP2 I/O Mixed Unit	DC input, Transistor output NPN	Input: 32 points Output: 32 points	Connector	Input: 24 V DC Output: 0.1 A (12 to 24 V DC), 50 mA (5 V DC)	FP2-XY64D2T	AFP23467
				Input: 24 V DC Output: 0.1 A (12 to 24 V DC), 50 mA (5 V DC) with ON pulse catch input	FP2-XY64D7T	AFP23477
	DC input, Transistor output PNP	Input: 32 points Output: 32 points	Connector	Input: 24 V DC Output: 0.1 A (12 to 24 V DC), 50 mA (5 V DC)	FP2-XY64D2P	AFP23567
				Input: 24 V DC Output: 0.1 A (12 to 24 V DC), 50 mA (5 V DC) with ON pulse catch input	FP2-XY64D7P	AFP23577

\* Pressure welding socket is supplied. A special tool (Part No.: **AXY52000FP**) is needed for connection.  
Please purchase separately if you are using a terminal or flat cable socket.

## Intelligent units for Analog I/O

Product name	Specifications	Number of I/O points	Product No.	Part No.
FP2 Analog Input Unit	<b>FP2-AD8VI</b> Between channels: Not insulated, Voltage: 1 to 5 V, ±10 V Current: 4 to 20 mA, ±20 mA	Analog input: 8 channels	<b>FP2-AD8VI</b>	<b>AFP2400L</b>
	<b>FP2-AD8X</b> Between channels: Insulated, Voltages, Currents, Thermocouples, R.T.D. (Resistance Thermometer Devices)	Analog input: 8 channels	<b>FP2-AD8X</b>	<b>AFP2401</b>
	<b>FP2-RTD</b> R.T.D.: Pt100, JPt100, JPt1000 type	R.T.D. input: 8 channels	<b>FP2-RTD</b>	<b>AFP2402</b>
FP2 Analog Output Unit	Voltage: -10 to +10 V, Current: 0 to 20 mA, Resolution: 1/4,096	Analog output: 4 channels	<b>FP2-DA4</b>	<b>AFP2410</b>

## Positioning units, High-speed counter units and Pulse I/O units

Product name	Specifications			Product No.	Part No.
	Output type	Number of axes controlled	Speed command		
FP2 Positioning Unit RTEX	Network	2 axes type	1 pps to 32 Mpps	<b>FP2-PN2AN</b>	<b>AFP243610</b>
		4 axes type		<b>FP2-PN4AN</b>	<b>AFP243620</b>
		8 axes type		<b>FP2-PN8AN</b>	<b>AFP243630</b>
Control Configurator PM	Dedicated tool software for positioning unit RTEX, Japanese version			<b>AFPS66110</b>	<b>AFPS66110</b>
	Dedicated tool software for positioning unit RTEX, English version			<b>AFPS66510</b>	<b>AFPS66510</b>
FP2 Positioning Unit Multi function type (Note 3)	Transistor	2 axes, independent	1 pps to 500 kpps	<b>FP2-PP21</b>	<b>AFP2432</b>
		4 axes, independent		<b>FP2-PP41</b>	<b>AFP2433</b>
	Line driver	2 axes, independent	1 pps to 4 Mpps	<b>FP2-PP22</b>	<b>AFP2434</b>
		4 axes, independent		<b>FP2-PP42</b>	<b>AFP2435</b>
FP2 Positioning Unit Interpolation type	Transistor	2 axes (Linear/circular, interpolation and synchronization)	1 pps to 500 kpps	<b>FP2-PP2T</b>	<b>AFP243710</b>
		4 axes (2-axis linear, 2-axis circular, 3-axis linear, 3-axis spiral interpolation and 2-axis synchronization)		<b>FP2-PP4T</b>	<b>AFP243720</b>
	Line driver	2 axes (Linear/circular, interpolation and synchronization)	1 pps to 4 Mpps	<b>FP2-PP2L</b>	<b>AFP243711</b>
		4 axes (2-axis linear, 2-axis circular, 3-axis linear, 3-axis spiral interpolation and 2-axis synchronization)		<b>FP2-PP4L</b>	<b>AFP243721</b>
FP2 High-speed Counter Unit	8 interrupt inputs, 4-channel high-speed counter, 8 comparison outputs, Input: 24 V DC, Output: 5 to 24 V DC (0.1 A, 12 points / 0.8 A, 4 points)	NPN output PNP output	<b>FP2-HSCT</b> <b>FP2-HSCP</b>	<b>AFP2441</b> <b>AFP2451</b>	
FP2 Pulse I/O Unit	8 interrupt inputs, 4-channel high-speed counter, 8 comparison outputs, 4-channel pulse output, 4-channel PWM output, Input: 24 V DC, Output: 5 to 24 V DC (0.1 A, 12 points / 0.8 A, 4 points)	NPN output PNP output	<b>FP2-PXYT</b> <b>FP2-PXYP</b>	<b>AFP2442</b> <b>AFP2452</b>	

Notes:

- 1) Pressure welding socket is supplied. A special tool (Part No. **AXY52000FP**) is needed for connection. Please purchase separately if you are using a terminal or flat cable socket.
- 2) Please refer to "FP2 catalog" for model No. of Motor driver I/F terminal II.
- 3) Previous **FP2** positioning units (**AFP2430** and **AFP2431**) are not compatible with the multi function type **FP2** positioning unit. Please contact us.

## Serial communication and link-related intelligent units

Product name	Specifications	Number of channel	Product No.	Part No.	
FP2 VE2 Link Unit	10 Mbps, 8,192 points / 8,192 words, Max. 99 units (VE mode), Max. 254 units (FL-net), 2,500 m <b>8,202 ft</b>	1 channel	<b>FP2-VE2</b>	<b>AFP279601</b>	
FP2 ET-LAN2 Unit	Ethernet-compatible unit for <b>FP2SH</b> To be mounted on the CPU backplane	1 channel	<b>FP2-ET2</b>	<b>AFP27901</b>	
Control Configurator ET	ET-LAN unit setting software, Japanese version	-	<b>AFPS32110</b>	<b>AFPS32110</b>	
	ET-LAN unit setting software, English version	-	<b>AFPS32510</b>	<b>AFPS32510</b>	
FP2 Multi-wire Link Unit	For PLC links Compatible with MEWNET-W / MEWNET-W2	1 channel	<b>FP2-MW</b>	<b>AFP2720</b>	
FP2 PROFIBUS DP Master Unit	Number of connectable units: 1 master unit and 127 slave units Transmission speed / distance: 9.6 kbps to 12 Mbps / 12 km <b>39,370 ft</b> (when using a repeater)	-	-	<b>AFP27971</b>	
FP2 DeviceNet Master Unit	Number of connectable units: 1 master unit and 63 slave units Transmission speed / distance: 500 kbps / 100 m <b>328 ft</b> , 250 kbps / 250 m <b>820 ft</b> , 150 kbps / 500 m <b>1,640 ft</b>	-	-	<b>AFP27972</b>	
FP2 CANopen Master Unit	Number of connectable units: 127, including master and slave units Transmission speed / distance: 1 Mbps / 25 m <b>82 ft</b> , 10 kbps / 500 m <b>1,640 ft</b>	-	-	<b>AFP27973</b>	
FP2 FNS Unit	Can be connected to PROFIBUS DP / DeviceNet / CANopen as a slave unit by selecting a communication block.	1 channel	<b>FP2-FNS</b>	<b>AFP27930</b>	
FP2 Multi-Communication Unit	Communication block	For connection to PROFIBUS DP as a slave unit	-	<b>AFPN-AB6200</b>	<b>AFPN-AB6200</b>
	Communication block	For connection to DeviceNet as a slave unit	-	<b>AFPN-AB6201</b>	<b>AFPN-AB6201</b>
	Communication block	For connection to CANopen as a slave unit	-	<b>AFPN-AB6218</b>	<b>AFPN-AB6218</b>
		Up to two blocks to be attached can be selected among RS232C, RS422, and RS485 blocks. General-purpose serial communications, computer links, PLC links (MEWNET-W0)	2 channels	<b>FP2-MCU</b>	<b>AFP2465</b>
	RS232C block (For the multi-communication unit) Max. 230 kbps, 15 m <b>49 ft</b>	1 channel	<b>FP2-CB232</b>	<b>AFP2803</b>	
	RS422 block (For the multi-communication unit) Max. 230 kbps, 1,200 m <b>3,937 ft</b>	1 channel	<b>FP2-CB422</b>	<b>AFP2804</b>	
	RS485 block (For the multi-communication unit) For PLC links (MEWNET-W0): 115 kbps, 16 stations, 1,200 m <b>3,937 ft</b>	1 channel	<b>FP2-CB485</b>	<b>AFP2805</b>	

## Intelligent units for remote I/O control

Product name	Specifications	Controllable I/O points	Product No.	Part No.		
FP2 Multi-wire Link Unit	Can connect as the remote I/O system MEWNET-F master station. Perfect for remote I/O systems using many points	Max. 4,096 points per one unit	<b>FP2-SMW</b>	<b>AFP2720</b>		
FP2 Remote I/O Slave Unit	Can connect as the remote I/O system MEWNET-F slave station. I/O unit and positioning unit can be attached.	Max. 3,072 points per one unit	<b>FP2-RMS</b>	<b>AFP2745</b>		
FP I/O Terminal Board [MIL connector type]	12 V DC input / 0.2 A Transistor output	Input: 16 points, Output: 16 points	<b>AFP87445</b>	<b>AFP87445</b>		
	24 V DC input / 0.2 A Transistor output	Input: 16 points, Output: 16 points	<b>AFP87446</b>	<b>AFP87446</b>		
FP I/O Terminal Board [Terminal block type]	24 V DC input / 0.2 A Transistor output	Input: 16 points, Output: 16 points	<b>AFP87444</b>	<b>AFP87444</b>		
	24 V DC input / 2 A Relay output	Input: 16 points, Output: 8 points	<b>AFP87432</b>	<b>AFP87432</b>		
FP I/O Terminal Unit	Serves as a slave controller. Expandable up to 32 points. (Operating voltage: 24 V DC)	FP I/O Terminal Unit (basic)	Input unit 24 V DC input	Input 8 points	<b>AFP87421</b>	<b>AFP87421</b>
			Input 16 points	<b>AFP87422</b>	<b>AFP87422</b>	
		FP I/O Terminal Expansion Unit	Output unit 0.5 A Transistor output	Output 8 points	<b>AFP87423</b>	<b>AFP87423</b>
				Output 16 points	<b>AFP87424</b>	<b>AFP87424</b>
			Input unit 24 V DC input	Input 8 points	<b>AFP87425</b>	<b>AFP87425</b>
				Input 16 points	<b>AFP87426</b>	<b>AFP87426</b>
Output unit 0.5 A Transistor output	Output 8 points	<b>AFP87427</b>	<b>AFP87427</b>			
	Output 16 points	<b>AFP87428</b>	<b>AFP87428</b>			
FP2 S-LINK Unit	Direct connection to S-LINK reduced-wiring system Unit with 128 points × 2 channels	128 points per one unit	<b>FP2-SL2</b>	<b>AFP2780</b>		

## Maintenance parts

Product name	Specifications	Product No.	Part No.
Spare battery	For <b>FP2SH</b> CPU unit, battery with cable	<b>AFP8801</b>	<b>AFP8801</b>
Dummy unit	For blank slot	<b>FP2-DM</b>	<b>AFP2300</b>
Small PC card	For <b>AFP2209</b>	-	<b>AFP2806</b>
Terminal block for <b>FP2</b> I/O unit	<b>FP2</b> I/O unit (terminal block type) supplied. (5 pieces)	-	<b>AFP2800</b>
Discrete-wire connector set (supplied)	<b>FP2</b> I/O unit and positioning unit supplied. (2 pieces)	-	<b>AFP2801</b>
Flat cable connector set (40 leads)	For <b>FP2</b> I/O unit and positioning unit. For simple connection using a flat cable. (2 pieces)	-	<b>AFP2802</b>
Multi-wire connector pressure contact tool	Necessary when wiring transistor output type connectors.	-	<b>AXY52000FP</b>

## Control FPCWIN Pro (IEC61131-3 compliant Windows version software)

○: Available

Product name	Type	Part No.	Applicable model										
			FP2	FP2SH	FP-X	FPΣ	FP0 FP-e	FP0R	FP1*	FP-M*	FP3* FP10SH		
Windows version tool software <b>Control FPCWIN Pro</b>	Japanese version	CD-ROM for Windows	<b>AFPS50160</b>	○	○	○	○	○	○	○	○	○	○
	English version	CD-ROM for Windows	<b>AFPS50560</b>	○	○	○	○	○	○	○	○	○	○

\* The production of **FP1**, **FP-M**, **FP3** and **FP10SH** has been discontinued.

Note: **FP-X** compatible versions: Relay output type - Ver. 5.1 or later; Transistor output type - Ver. 5.3 or later

## Control FPCWIN GR (Windows version software)

○: Available  
x: Not available

Product name	Type		Product No.	Part No.	Applicable model									
					FP2	FP2SH	FP-X	FPΣ	FP0 FP-e	FP0R	FP1*	FP-M*	FP3* FP10SH	
Windows version tool software <b>Control FPCWIN GR</b>	Japanese version tool kit with cable	CD-ROM for Windows, with cable (AFC8503) for connection of FP to DOS/V PC	<b>FPWINGRF-JP2</b>	<b>AFPS10122</b>	○	○	○	○	○	○	○	○	○	
	English version, Full type	CD-ROM for Windows	<b>FPWINGRF-EN2</b>	<b>AFPS10520</b>										
	English version, Small type	CD-ROM for Windows	<b>FPWINGRF-EN2</b>	<b>AFPS11520</b>	x	x	○	○	○	○	○	○	x	
	Chinese version	CD-ROM for Windows	<b>FPWINGRF-CN2</b>	<b>AFPS10820</b>	○	○	○	○	○	○	○	○	○	
	Korean version	CD-ROM for Windows	<b>FPWINGRF-KR2</b>	<b>AFPS10920</b>	○	○	○	○	○	○	○	○	○	

\* The production of **FP1**, **FP-M**, **FP3** and **FP10SH** has been discontinued.

Note: **FP-X** compatible versions: Relay output type - Ver. 2.50 or later; Transistor output type - Ver. 2.70 or later

## Dimensions (Unit: mm in)

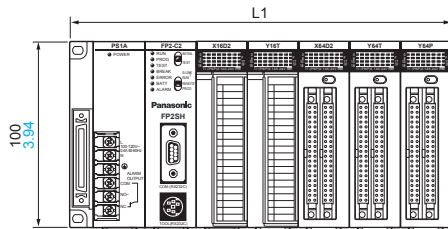

DIN standard rail attachment groove (DIN EN50022 35 mm 1.38 in width)

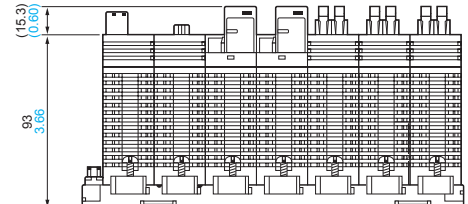
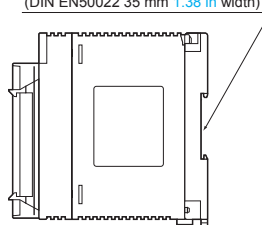

\* The illustration shows a conventional 7-module type backplane.

Mounting dimension (Tolerance:  $\pm 1.0 \pm 0.04$ )

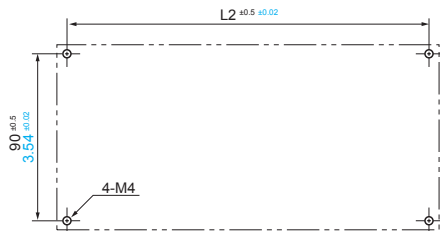

### Conventional backplanes

	5-module	7-module	9-module	12-module	14-module
L1 (mm in)	140 5.51	209 8.23	265 10.43	349 13.74	405 15.94
L2 (mm in)	130 5.12	199 7.83	255 10.04	339 13.35	395 15.55

Note: The 5-module type does not have an expansion connector.

### H type backplanes

	11-module (master backplane)	10-module (expansion backplane)
L1 (mm in)	349 13.74	349 13.74
L2 (mm in)	339 13.35	339 13.35

Please contact .....

## Panasonic Industrial Devices SUNX Co., Ltd.

2431-1 Ushiyama-cho, Kasugai-shi, Aichi, 486-0901, Japan

■Telephone: +81-568-33-7211 ■Facsimile: +81-568-33-2631

Global Sales Department

■Telephone: +81-568-33-7861 ■Facsimile: +81-568-33-8591

panasonic.net/id/pidsx/global

**Panasonic**<sup>®</sup>

All Rights Reserved ©Panasonic Industrial Devices SUNX Co., Ltd. 2012