

SERIES: VSK-S3 | **DESCRIPTION:** AC-DC POWER SUPPLY

FEATURES

- up to 3 W continuous power
- compact board mount design
- universal input (85~264 Vac / 110~370 Vdc)
- single output from 3.3~24 V
- over voltage, over temperature, and short circuit protections
- UL/cUL safety approvals
- efficiency up to 78%



| MODEL | output voltage | output current | output power | ripple and noise ¹ | efficiency |
|-------------|----------------|----------------|--------------|-------------------------------|------------|
| | (Vdc) | max (A) | max (W) | typ (mVp-p) | typ (%) |
| VSK-S3-3R3U | 3.3 | 0.7 | 2.3 | 30 | 63 |
| VSK-S3-5U | 5 | 0.6 | 3 | 30 | 72 |
| VSK-S3-9U | 9 | 0.33 | 3 | 30 | 74 |
| VSK-S3-12U | 12 | 0.25 | 3 | 30 | 76 |
| VSK-S3-15U | 15 | 0.2 | 3 | 30 | 76 |
| VSK-S3-24U | 24 | 0.125 | 3 | 30 | 78 |

Notes: 1. Ripple and noise measured at 20 MHz bandwidth

PART NUMBER KEY

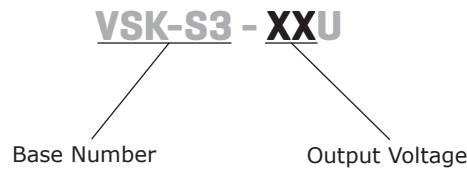

INPUT

| parameter | conditions/description | min | typ | max | units |
|--------------------------------------|--------------------------|-----------|----------|------------|------------|
| voltage | | 85 110 | | 264 370 | Vac Vdc |
| frequency | | 47 | | 440 | Hz |
| current | at 110 Vac at 230 Vac | | 65 30 | | mA mA |
| inrush current | at 110 Vac at 230 Vac | | 10 20 | | A A |
| external input fuse (recommended) | slow blow, 250 V | | 0.5 | | A |

OUTPUT

| parameter | conditions/description | min | typ | max | units |
|-------------------------|---------------------------------|-----|----------|-----|--------|
| line regulation | | | ±0.5 | | % |
| load regulation | 10 ~ 100% | | ±1 | | % |
| temperature coefficient | | | 0.02 | | %/°C |
| hold-up time | at 230 Vac | | 50 | | ms |
| voltage accuracy | 3.3 V model all other models | | ±3 ±2 | | % % |
| switching frequency | | | 100 | | kHz |

PROTECTIONS

| parameter | conditions/description | min | typ | max | units |
|-----------------------------|---|-----|-----|-----|-------|
| over voltage protection | chip lock up | | | | |
| short circuit protection | auto recovery with no damage from a short on any output | | | | |
| over temperature protection | | | | 150 | °C |

SAFETY & COMPLIANCE

| parameter | conditions/description | min | typ | max | units |
|-------------------|--|---------|-----|-----|-------|
| isolation voltage | primary to secondary (for 1 minute) | 3,000 | | | Vac |
| safety approvals | UL 60950-1 | | | | |
| safety class | class II | | | | |
| EMI/EMC | EN 55022 (level A), IEC/EN 61000-4-2 (level 4, 8kV/15kV), IEC/EN 61000-4-3, IEC/EN 61000-4-4 (level 3, 2kV), IEC/EN 61000-4-5 (level 3, 1kV/2kV) | | | | |
| MTBF | 25°C | 300,000 | | | hrs |
| RoHS | 2011/65/EU | | | | |

ENVIRONMENTAL

| parameter | conditions/description | min | typ | max | units |
|-----------------------|------------------------|-----|-----|-----|-------|
| operating temperature | | -25 | | 70 | °C |
| storage temperature | | -40 | | 105 | °C |
| case temperature | | | | 95 | °C |
| operating humidity | non-condensing | | | 95 | % |

DERATING CURVES

1. output power vs. ambient temperature

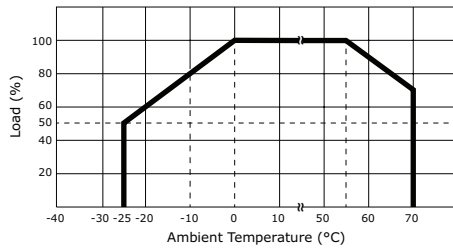

2. output power vs. input voltage

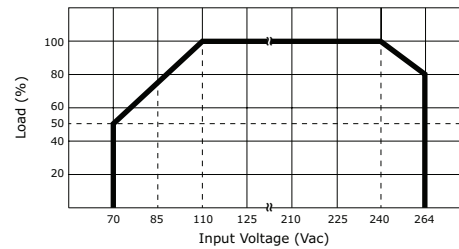

MECHANICAL

| parameter | conditions/description | min | typ | max | units |
|---------------|---|-----|-----|-----|-------|
| dimensions | 1.457 x 0.908 x 0.591 (37.0 x 23.0 x 15.0 mm) | | | | inch |
| case material | UL94V-0 | | | | |
| weight | | | 25 | | g |

MECHANICAL DRAWING

units: mm [inches]
 tolerance: ±0.5 [±0.02]
 pin section tolerance: ±0.10 [±0.004]

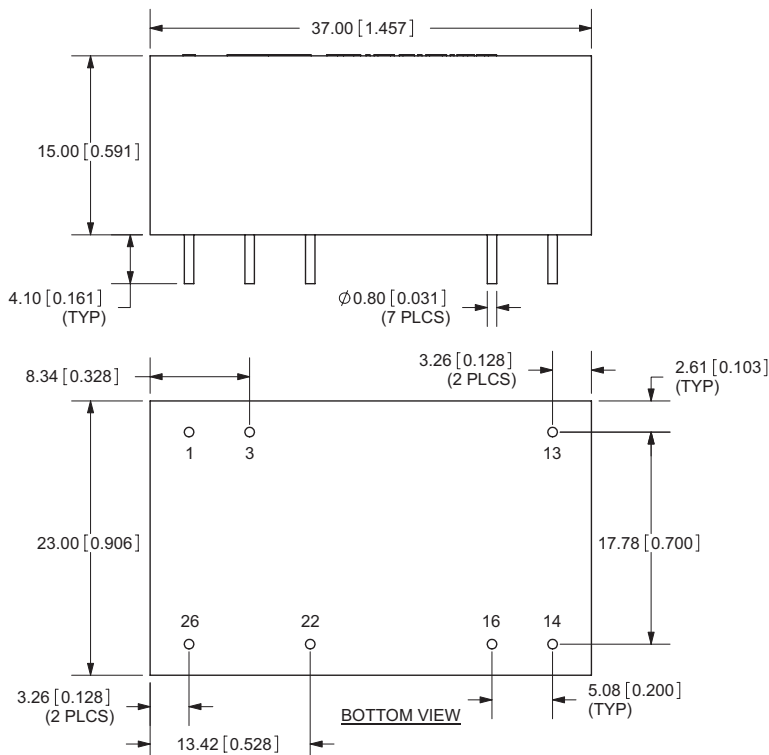
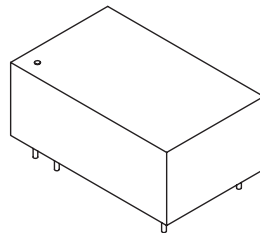

| PIN CONNECTIONS | |
|-----------------|----------|
| PIN | FUNCTION |
| 1 | L |
| 3 | N |
| 13 | N/C |
| 14 | 0V |
| 16 | +Vo |
| 22 | +Vin(DC) |
| 26 | -Vin(DC) |

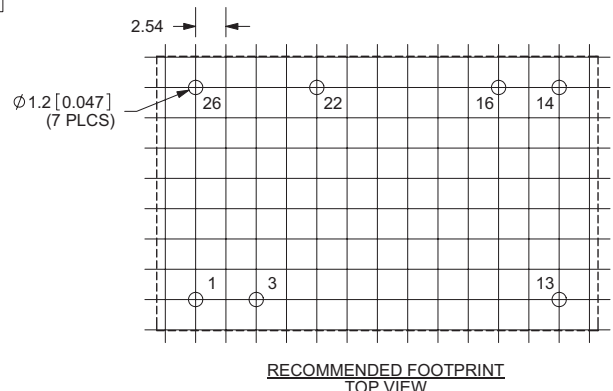

TYPICAL APPLICATION CIRCUIT

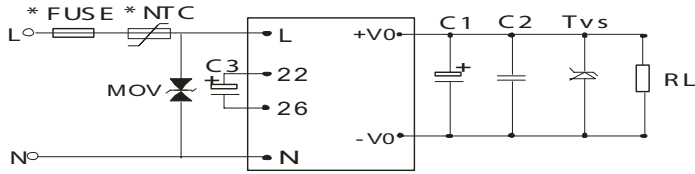

Figure1

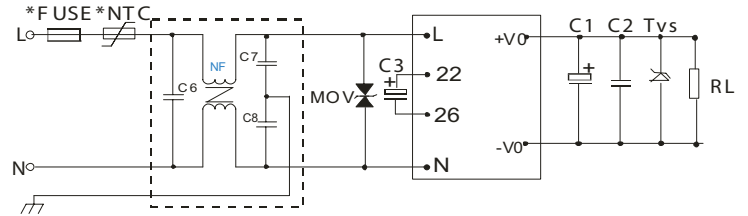

Figure 2 VSK-S3 EMC Filtering Circuit

EXTERNAL CAPACITORS TYPICAL VALUE (Unit: μF)

| MODEL | C1 | C2 | C3 | TVS |
|-------------|-----|-----|----------|----------|
| VSK-S3-3R3U | 150 | 0.1 | 4.7/400V | P4KE6.8A |
| VSK-S3-5U | 150 | 0.1 | 4.7/400V | P4KE6.8A |
| VSK-S3-9U | 150 | 0.1 | 4.7/400V | P4KE12A |
| VSK-S3-12U | 150 | 0.1 | 4.7/400V | P4KE20A |
| VSK-S3-15U | 150 | 0.1 | 4.7/400V | P4KE20A |
| VSK-S3-24U | 150 | 0.1 | 4.7/400V | P4KE30A |

- Notes:
- Output filtering capacitors C1, C3 is electrolytic capacitors, It is recommended to use high frequency and low impedance electrolytic capacitors. For capacitance and current of capacitor please refer to manufacture's datasheet. Voltage derating of apacitor should be 80% or above. C2, C4 is ceramic capacitors , it is used to filter high frequency noise. TVS is a recommended component to protect post-circuits (when converter fails).
 - MOV is required for VSK-S3 models. Model: 471KD05, it is used to protect the device under surge.
 - It is recommended to connect FUSE, the parameter is 0.5A/250V slow blow. External input NTC is recommended to use D -14 or 10 Ω /2W wire-round resistor.
 - If EMC performance is required, recommended to add "EMC filter" at the input end(see figure 2) C6:X capacitor, recommended parameter 0.1 μF /275V; C7,C8:Y capacitor, recommended parameter 220pF/275V; NF: common mode choke, recommended inductance is about 10mH-30mH.
 - Terminals 22 and 26 are internal rectification and filtering terminals. To protect the models further, it is recommended to connect an electrolytic capacitor C3 (it is recommended to be 4.7 μF /400V). If operation voltage of the module is between 160~264VAC, C3 can be removed.

REVISION HISTORY

| rev. | description | date |
|------|-----------------------------|------------|
| 1.0 | initial release | 02/27/2009 |
| 1.01 | new template applied | 04/10/2012 |
| 1.02 | V-Infinity branding removed | 08/15/2012 |
| 1.03 | updated spec | 03/31/2014 |

The revision history provided is for informational purposes only and is believed to be accurate.



Headquarters
20050 SW 112th Ave.
Tualatin, OR 97062
800.275.4899

Fax 503.612.2383
cui.com
techsupport@cui.com

CUI offers a two (2) year limited warranty. Complete warranty information is listed on our website.

CUI reserves the right to make changes to the product at any time without notice. Information provided by CUI is believed to be accurate and reliable. However, no responsibility is assumed by CUI for its use, nor for any infringements of patents or other rights of third parties which may result from its use.

CUI products are not authorized or warranted for use as critical components in equipment that requires an extremely high level of reliability. A critical component is any component of a life support device or system whose failure to perform can be reasonably expected to cause the failure of the life support device or system, or to affect its safety or effectiveness.