

NLAS4599

Low Voltage Single Supply SPDT Analog Switch

The NLAS4599 is an advanced high speed CMOS single pole – double throw analog switch fabricated with silicon gate CMOS technology. It achieves high speed propagation delays and low ON resistances while maintaining low power dissipation. This switch controls analog and digital voltages that may vary across the full power–supply range (from V_{CC} to GND).

The device has been designed so the ON resistance (R_{ON}) is much lower and more linear over input voltage than R_{ON} of typical CMOS analog switches.

The channel select input is compatible with standard CMOS outputs.

The channel select input structure provides protection when voltages between 0 V and 5.5 V are applied, regardless of the supply voltage. This input structure helps prevent device destruction caused by supply voltage – input/output voltage mismatch, battery backup, hot insertion, etc.

- Channel Select Input Over–Voltage Tolerant to 5.5 V
- Fast Switching and Propagation Speeds
- Break–Before–Make Circuitry
- Low Power Dissipation: $I_{CC} = 2 \mu A$ (Max) at $T_A = 25^\circ C$
- Diode Protection Provided on Channel Select Input
- Improved Linearity and Lower ON Resistance over Input Voltage
- Latch–up Performance Exceeds 300 mA
- ESD Performance: Human Body Model > 2000 V; Machine Model > 200 V
- Chip Complexity: 38 FETs
- Pb–Free Packages are Available

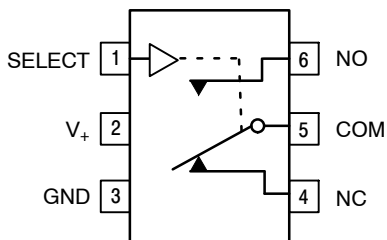

Figure 1. Pin Assignment

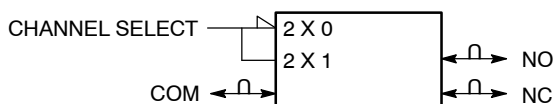

Figure 2. Logic Symbol

*For additional information on our Pb–Free strategy and soldering details, please download the ON Semiconductor Soldering and Mounting Techniques Reference Manual, SOLDERRM/D.



ON Semiconductor®

<http://onsemi.com>

MARKING DIAGRAMS



TSOP-6
DT SUFFIX
CASE 318G

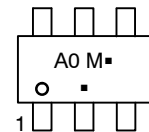

SC-88
DF SUFFIX
CASE 419B

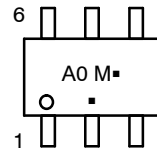

A0 = Specific Device Code
M = Date Code
▪ = Pb–Free Package
(Note: Microdot may be in either location)

ORDERING INFORMATION

See detailed ordering and shipping information in the package dimensions section on page 9 of this data sheet.

FUNCTION TABLE

Select	ON Channel
L	NC
H	NO

ABSOLUTE MAXIMUM RATINGS

Symbol	Parameter	Value	Unit
V _{CC}	Positive DC Supply Voltage	-0.5 to +7.0	V
V _{IS}	Analog Input Voltage (V _{NO} or V _{COM})	-0.5 ≤ V _{IS} ≤ V _{CC} + 0.5	V
V _{IN}	Digital Select Input Voltage	-0.5 ≤ V _I ≤ + 7.0	V
I _{IK}	DC Current, Into or Out of Any Pin	± 50	mA
P _D	Power Dissipation in Still Air	SC-88 200 TSOP-6 200	mW
T _{STG}	Storage Temperature Range	-65 to +150	°C
T _L	Lead Temperature, 1mm from Case for 10 seconds	260	°C
T _J	Junction Temperature Under Bias	150	°C
V _{ESD}	ESD Withstand Voltage	Human Body Model (Note 1) 2000 Machine Model (Note 2) 200 Charged Device Model (Note 3) N/A	V
I _{LATCH-UP}	Latch-Up Performance	Above V _{CC} and Below GND at 125°C (Note 4)	± 300 mA
θ _{JA}	Thermal Resistance	SC-88 333 TSOP-6 333	°C/W

Stresses exceeding Maximum Ratings may damage the device. Maximum Ratings are stress ratings only. Functional operation above the Recommended Operating Conditions is not implied. Extended exposure to stresses above the Recommended Operating Conditions may affect device reliability.

1. Tested to EIA/JESD22-A114-A
2. Tested to EIA/JESD22-A115-A
3. Tested to JESD22-C101-A
4. Tested to EIA/JESD78

RECOMMENDED OPERATING CONDITIONS

Symbol	Characteristics	Min	Max	Unit
V _{CC}	DC Supply Voltage	2.0	5.5	V
V _{IN}	Digital Select Input Voltage	GND	5.5	V
V _{IS}	Analog Input Voltage (NC, NO, COM)	GND	V _{CC}	V
T _A	Operating Temperature Range	-55	+125	°C
t _r , t _f	Input Rise or Fall Time, SELECT	V _{CC} = 3.3 V ± 0.3 V 0 V _{CC} = 5.0 V ± 0.5 V 0	100 20	ns/V

DEVICE JUNCTION TEMPERATURE VERSUS TIME TO 0.1% BOND FAILURES

Junction Temperature °C	Time, Hours	Time, Years
80	1,032,200	117.8
90	419,300	47.9
100	178,700	20.4
110	79,600	9.4
120	37,000	4.2
130	17,800	2.0
140	8,900	1.0

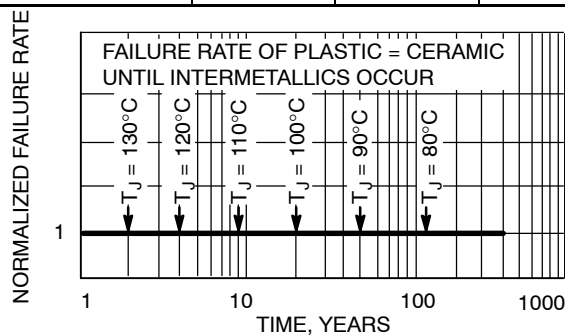

Figure 3. Failure Rate vs. Time Junction Temperature

NLAS4599

DC CHARACTERISTICS – Digital Section (Voltages Referenced to GND)

Symbol	Parameter	Condition	V _{CC}	Guaranteed Limit			Unit
				-55 to 25°C	<85°C	<125°C	
V _{IH}	Minimum High-Level Input Voltage, Select Input		2.0	1.5	1.5	1.5	V
			2.5	1.9	1.9	1.9	
			3.0	2.1	2.1	2.1	
			4.5	3.15	3.15	3.15	
			5.5	3.85	3.85	3.85	
V _{IL}	Maximum Low-Level Input Voltage, Select Input		2.0	0.5	0.5	0.5	V
			2.5	0.6	0.6	0.6	
			3.0	0.9	0.9	0.9	
			4.5	1.35	1.35	1.35	
			5.5	1.65	1.65	1.65	
I _{IN}	Maximum Input Leakage Current, Select Input	V _{IN} = 5.5 V or GND	5.5	±0.1	±1.0	±1.0	μA
I _{OFF}	Power Off Leakage Current	V _{IN} = 5.5 V or GND	0	± 10	± 10	± 10	μA
I _{CC}	Maximum Quiescent Supply Current	Select and V _{IS} = V _{CC} or GND	5.5	1.0	1.0	2.0	μA

DC ELECTRICAL CHARACTERISTICS – Analog Section

Symbol	Parameter	Condition	V _{CC}	Guaranteed Limit			Unit
				-55 to 25°C	<85°C	<125°C	
R _{ON}	Maximum "ON" Resistance (Figures 17 – 23)	V _{IN} = V _{IL} or V _{IH} V _{IS} = GND to V _{CC} I _{IN} ≤ 10.0 mA	2.5	85	95	105	Ω
			3.0	45	50	55	
			4.5	30	35	40	
			5.5	25	30	35	
R _{FLAT (ON)}	ON Resistance Flatness (Figures 17 – 23)	V _{IN} = V _{IL} or V _{IH} I _{IN} ≤ 10.0 mA V _{IS} = 1V, 2V, 3.5V	4.5	4	4	5	Ω
ΔR _{ON (ON)}	ON Resistance Match Between Channels	V _{IN} = V _{IL} or V _{IH} I _{IN} ≤ 10.0 mA V _{NO} or V _{NC} = 3.5 V	4.5	2	2	3	Ω
I _{NC(OFF)} I _{NO(OFF)}	NO or NC Off Leakage Current (Figure 9)	V _{IN} = V _{IL} or V _{IH} V _{NO} or V _{NC} = 1.0 V _{COM} 4.5 V	5.5	1	10	100	nA
I _{COM(ON)}	COM ON Leakage Current (Figure 9)	V _{IN} = V _{IL} or V _{IH} V _{NO} 1.0 V or 4.5 V with V _{NC} floating or V _{NO} 1.0 V or 4.5 V with V _{NO} floating V _{COM} = 1.0 V or 4.5 V	5.5	1	10	100	nA

NLAS4599

AC ELECTRICAL CHARACTERISTICS (Input $t_r = t_f = 3.0$ ns)

Symbol	Parameter	Test Conditions	V _{CC} (V)	V _{IS} (V)	Guaranteed Max Limit						Unit	
					-55 to 25°C			<85°C		<125°C		
					Min	Typ*	Max	Min	Max	Min		Max
t _{ON}	Turn-On Time (Figures 12 and 13)	R _L = 300 Ω, C _L = 35 pF (Figures 5 and 6)	2.5	2.0	5	23	28	5	30	5	30	ns
			3.0	2.0	5	16	21	5	25	5	25	
			4.5	3.0	2	11	16	2	20	2	20	
			5.5	3.0	2	9	14	2	20	2	20	
t _{OFF}	Turn-Off Time (Figures 12 and 13)	R _L = 300 Ω, C _L = 35 pF (Figures 5 and 6)	2.5	2.0	1	7	12	1	15	1	15	ns
			3.0	2.0	1	5	10	1	15	1	15	
			4.5	3.0	1	4	9	1	12	1	12	
			5.5	3.0	1	3	8	1	12	1	12	
t _{BBM}	Minimum Break-Before-Make Time	V _{IS} = 3.0 V (Figure 4) R _L = 300 Ω, C _L = 35 pF	2.5	2.0	1	12		1		1		ns
			3.0	2.0	1	11		1		1		
			4.5	3.0	1	6		1		1		
			5.5	3.0	1	5		1		1		

*Typical Characteristics are at 25°C.

		Typical @ 25, V _{CC} = 5.0 V	
C _{IN}	Maximum Input Capacitance, Select Input	8	pF
C _{NO} or C _{NC}	Analog I/O (switch off)	10	
C _{COM}	Common I/O (switch off)	10	
C _(ON)	Feedthrough (switch on)	20	

ADDITIONAL APPLICATION CHARACTERISTICS (Voltages Referenced to GND Unless Noted)

Symbol	Parameter	Condition	V _{CC} (V)	Typical	Unit
				25°C	
BW	Maximum On-Channel -3dB Bandwidth or Minimum Frequency Response (Figure 10)	V _{IN} = 0 dBm V _{IN} centered between V _{CC} and GND (Figure 7)	3.0	170	MHz
			4.5	200	
			5.5	200	
V _{ONL}	Maximum Feedthrough On Loss	V _{IN} = 0 dBm @ 100 kHz to 50 MHz V _{IN} centered between V _{CC} and GND (Figure 7)	3.0	-3	dB
			4.5	-3	
			5.5	-3	
V _{ISO}	Off-Channel Isolation (Figure 10)	f = 100 kHz; V _{IS} = 1 V RMS V _{IN} centered between V _{CC} and GND (Figure 7)	3.0	-93	dB
			4.5	-93	
			5.5	-93	
Q	Charge Injection Select Input to Common I/O (Figure 15)	V _{IN} = V _{CC} to GND, F _{IS} = 20 kHz t _r = t _f = 3 ns R _{IS} = 0 Ω, C _L = 1000 pF Q = C _L * ΔV _{OUT} (Figure 8)	3.0	1.5	pC
			5.5	3.0	
THD	Total Harmonic Distortion THD + Noise (Figure 14)	F _{IS} = 20 Hz to 100 kHz, R _L = R _{gen} = 600 Ω, C _L = 50 pF V _{IS} = 5.0 V _{PP} sine wave	5.5	0.1	%

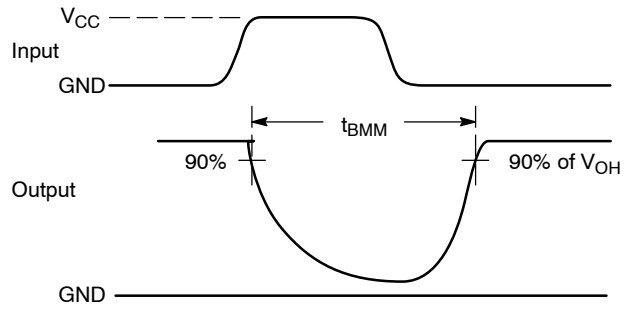
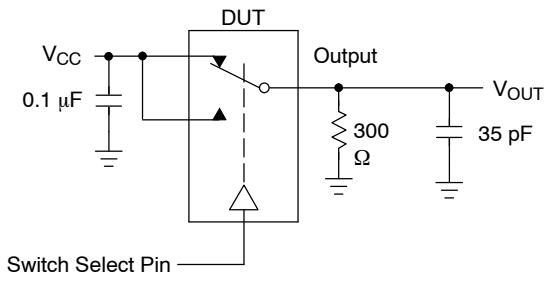

Figure 4. t_{BMM} (Time Break-Before-Make)

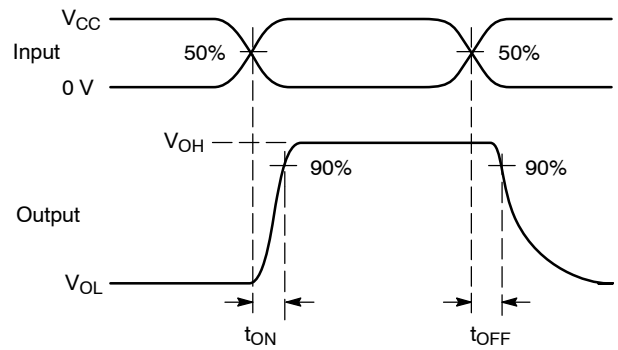
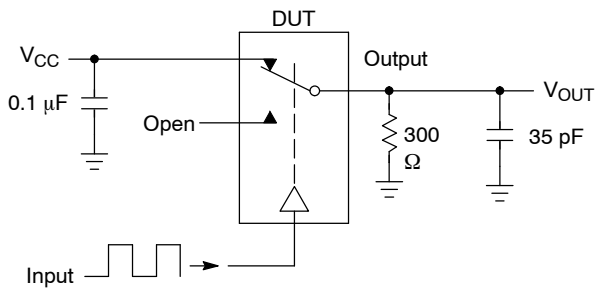

Figure 5. $t_{\text{ON}}/t_{\text{OFF}}$

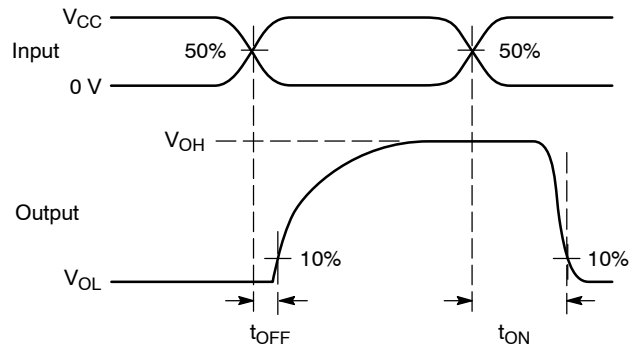
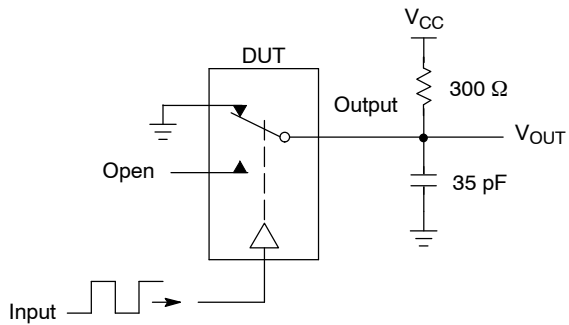
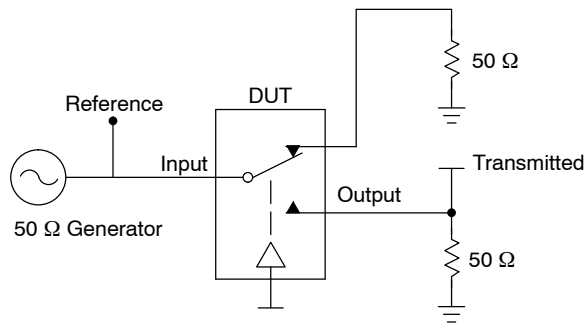

Figure 6. $t_{\text{ON}}/t_{\text{OFF}}$



Channel switch control/s test socket is normalized. Off isolation is measured across an off channel. On loss is the bandwidth of an On switch. V_{ISO} , Bandwidth and V_{ONL} are independent of the input signal direction.

$$V_{ISO} = \text{Off Channel Isolation} = 20 \text{ Log} \left(\frac{V_{OUT}}{V_{IN}} \right) \text{ for } V_{IN} \text{ at } 100 \text{ kHz}$$

$$V_{ONL} = \text{On Channel Loss} = 20 \text{ Log} \left(\frac{V_{OUT}}{V_{IN}} \right) \text{ for } V_{IN} \text{ at } 100 \text{ kHz to } 50 \text{ MHz}$$

Bandwidth (BW) = the frequency 3 dB below V_{ONL}

Figure 7. Off Channel Isolation/On Channel Loss (BW)/Crosstalk (On Channel to Off Channel)/ V_{ONL}

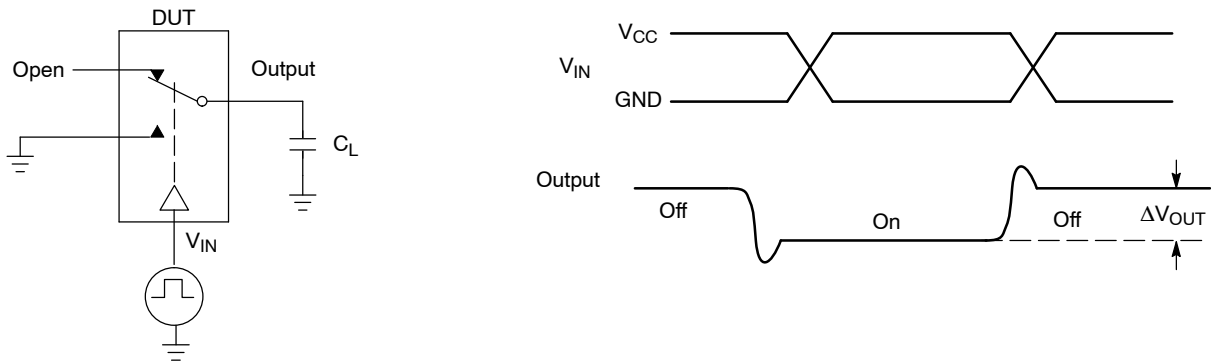

Figure 8. Charge Injection: (Q)

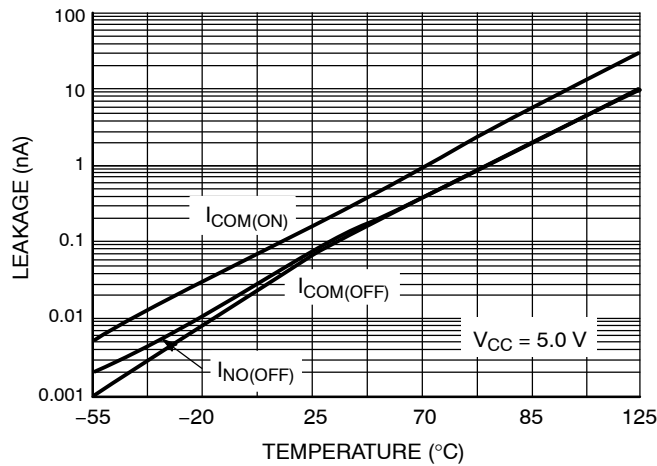

Figure 9. Switch Leakage vs. Temperature

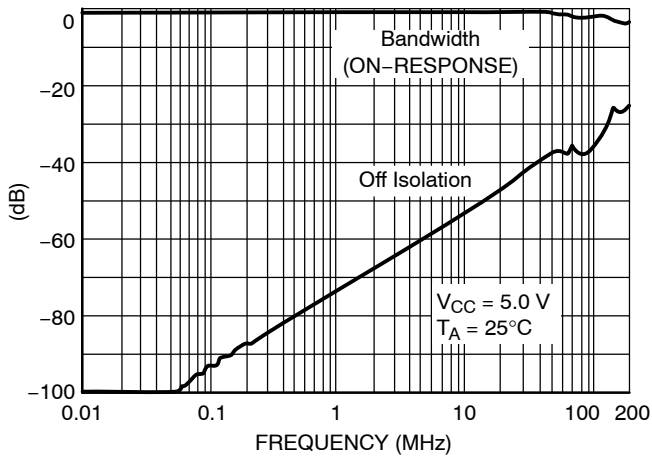

Figure 10. Bandwidth and Off-Channel Isolation

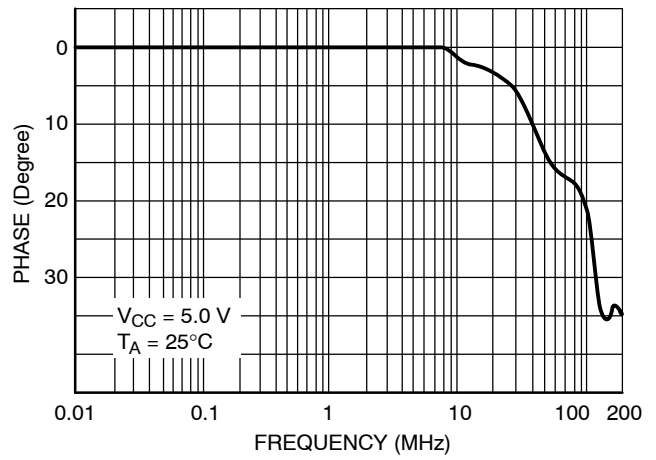

Figure 11. Phase vs. Frequency

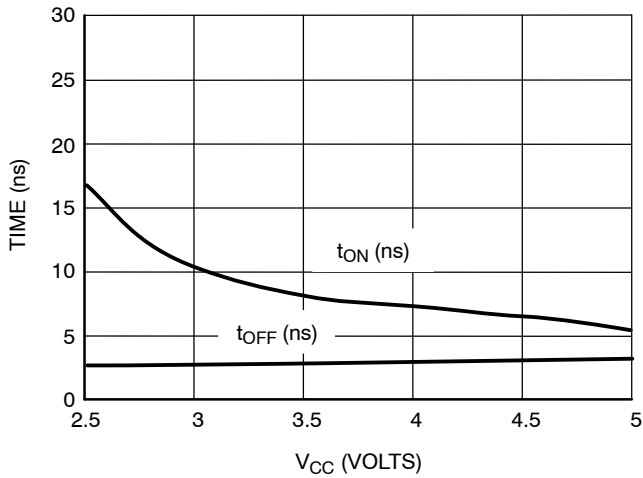

Figure 12. t_{ON} and t_{OFF} vs. V_{CC} at 25°C

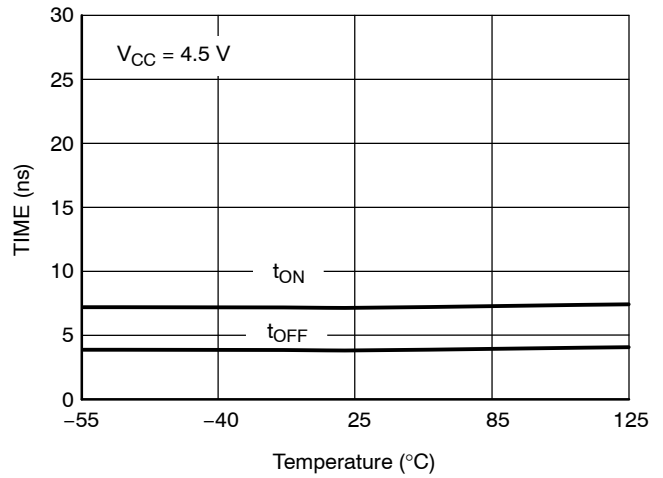

Figure 13. t_{ON} and t_{OFF} vs. Temp

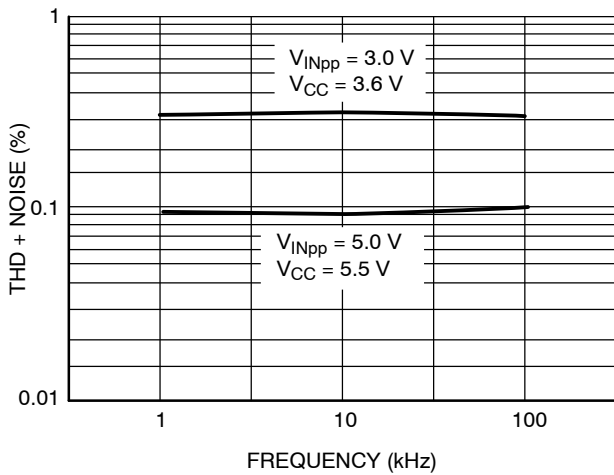

Figure 14. Total Harmonic Distortion Plus Noise vs. Frequency

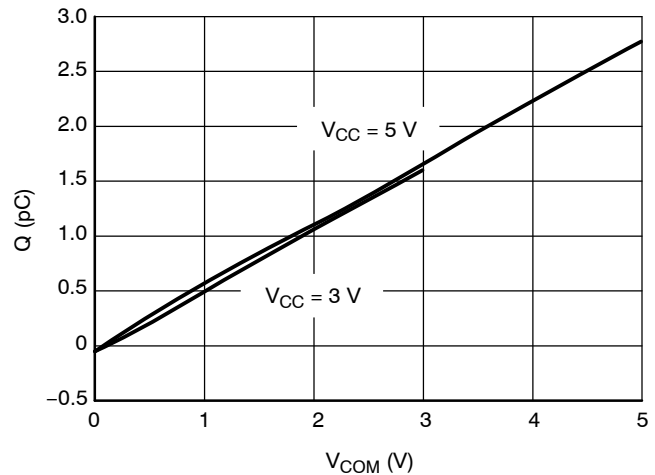

Figure 15. Charge Injection vs. COM Voltage

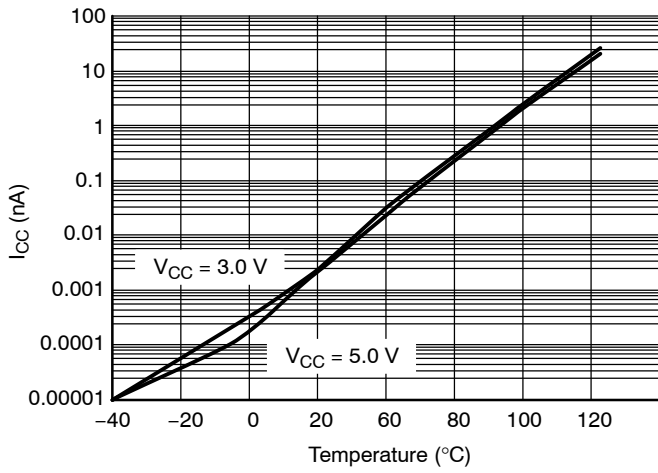

Figure 16. I_{CC} vs. Temp, $V_{CC} = 3\text{ V}$ & 5 V

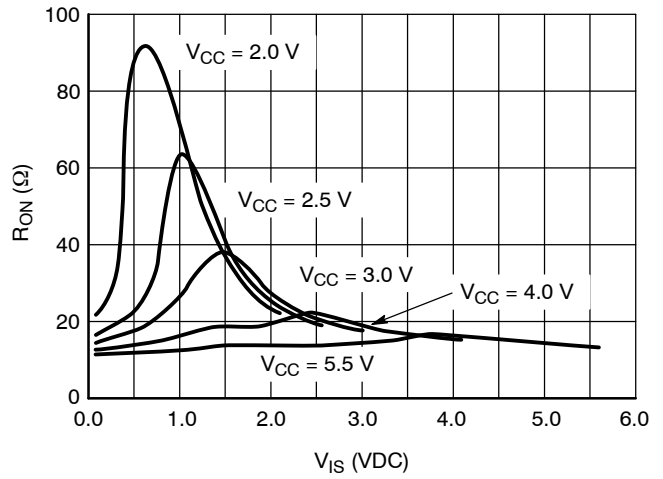

Figure 17. R_{ON} vs. V_{CC} , Temp = 25°C

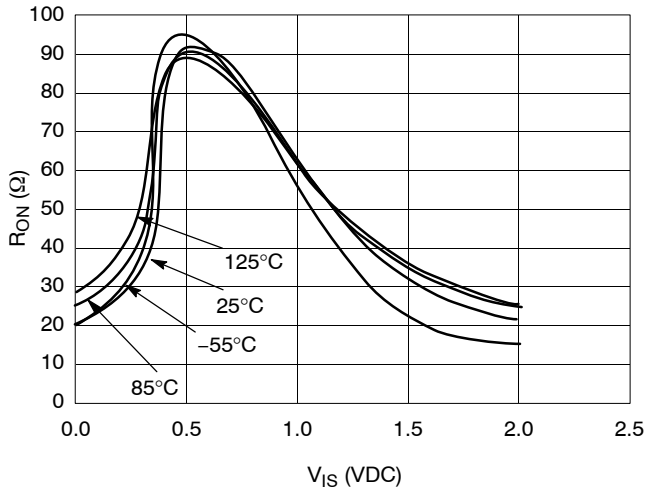

Figure 18. R_{ON} vs Temp, $V_{CC} = 2.0\text{ V}$

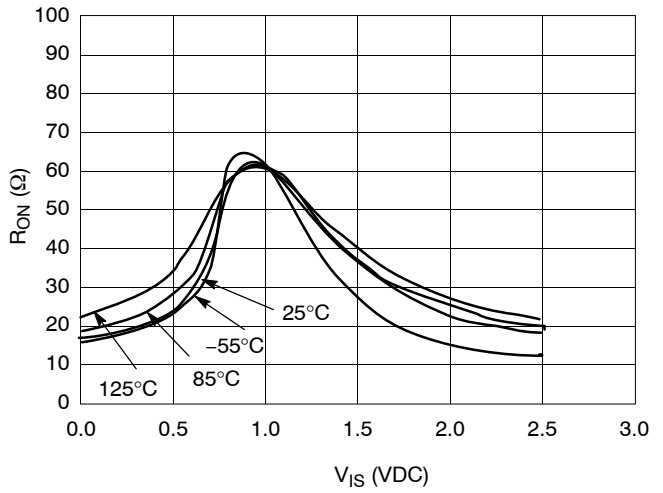

Figure 19. R_{ON} vs. Temp, $V_{CC} = 2.5\text{ V}$

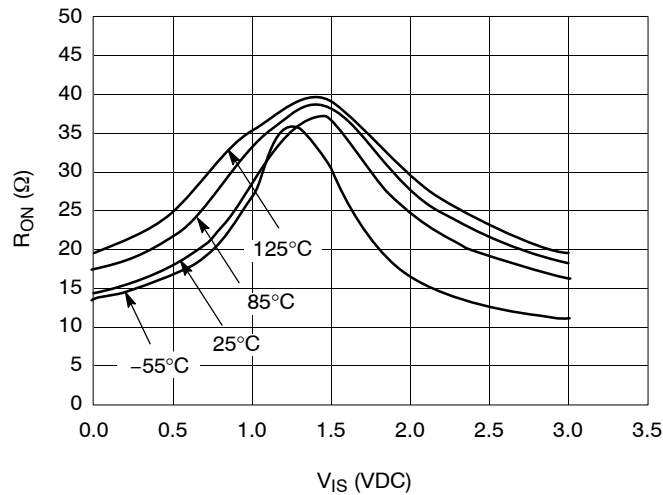

Figure 20. R_{ON} vs. Temp, $V_{CC} = 3.0\text{ V}$

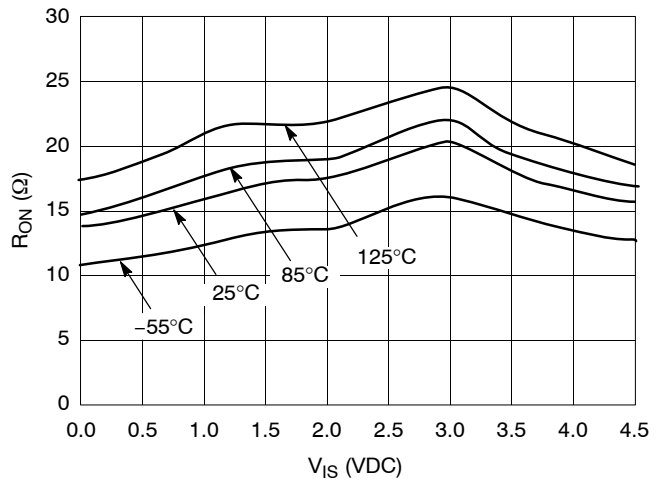

Figure 21. R_{ON} vs. Temp, $V_{CC} = 4.5\text{ V}$

NLAS4599

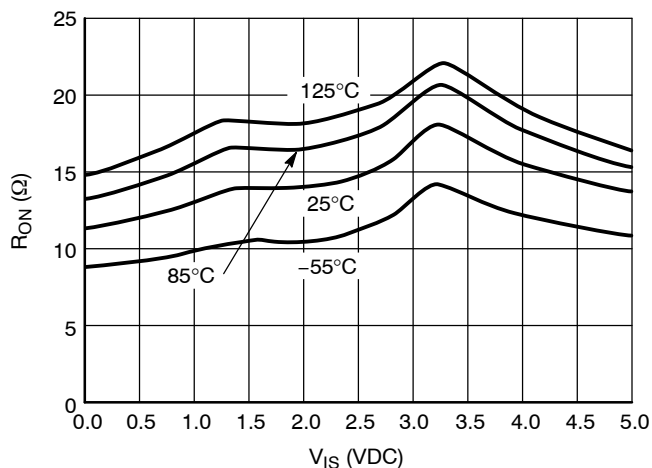

Figure 22. R_{ON} vs. Temp, $V_{CC} = 5.0$ V

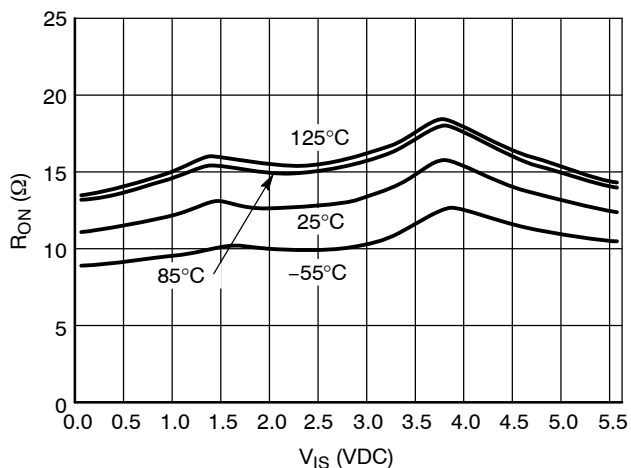

Figure 23. R_{ON} vs. Temp, $V_{CC} = 5.5$ V

ORDERING INFORMATION

Device	Device Nomenclature				Package	Shipping [†]
	Circuit Indicator	Technology	Device Function	Suffix		
NLAS4599DFT2	NL	AS	DF	T2	SC-88	3000 / Tape & Reel
NLAS4599DFT2G	NL	AS	DF	T2G	SC-88 (Pb-Free)	3000 / Tape & Reel
NLAS4599DTT1	NL	AS	DT	T1	TSOP-6	3000 / Tape & Reel
NLAS4599DTT1G	NL	AS	DT	T1G	TSOP-6 (Pb-Free)	3000 / Tape & Reel
NLVA4599DFT2	NL	AS	DF	T2	SC-88	3000 / Tape & Reel
NLVA4599DFT2G	NL	AS	DF	T2G	SC-88 (Pb-Free)	3000 / Tape & Reel
NLVA4599DTT1G	NL	AS	DT	T1G	TSOP-6 (Pb-Free)	3000 / Tape & Reel

[†]For information on tape and reel specifications, including part orientation and tape sizes, please refer to our Tape and Reel Packaging Specifications Brochure, BRD8011/D.

NLAS4599

PACKAGE DIMENSIONS

SC-88/SC70-6/SOT-363 CASE 419B-02 ISSUE W

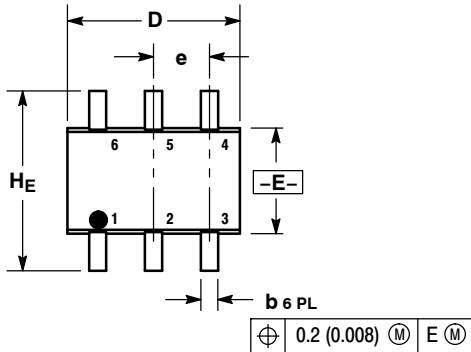

- NOTES:
 1. DIMENSIONING AND TOLERANCING PER ANSI Y14.5M, 1982.
 2. CONTROLLING DIMENSION: INCH.
 3. 419B-01 OBSOLETE, NEW STANDARD 419B-02.

DIM	MILLIMETERS			INCHES		
	MIN	NOM	MAX	MIN	NOM	MAX
A	0.80	0.95	1.10	0.031	0.037	0.043
A1	0.00	0.05	0.10	0.000	0.002	0.004
A3	0.20 REF			0.008 REF		
b	0.10	0.21	0.30	0.004	0.008	0.012
C	0.10	0.14	0.25	0.004	0.005	0.010
D	1.80	2.00	2.20	0.070	0.078	0.086
E	1.15	1.25	1.35	0.045	0.049	0.053
e	0.65 BSC			0.026 BSC		
L	0.10	0.20	0.30	0.004	0.008	0.012
H _E	2.00	2.10	2.20	0.078	0.082	0.086

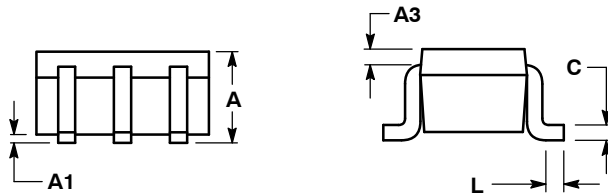

SOLDERING FOOTPRINT*

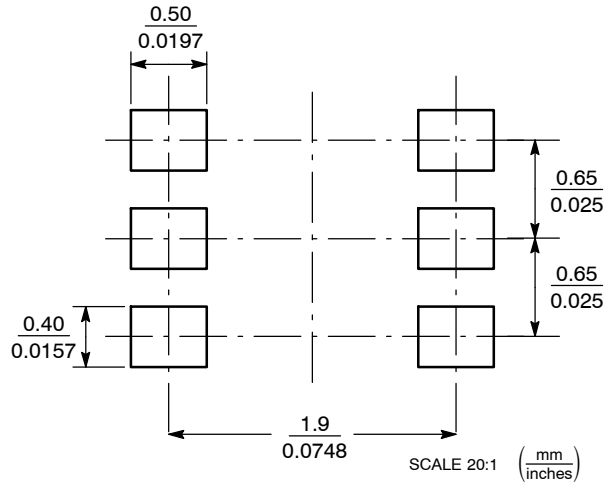

SC-88/SC70-6/SOT-363

*For additional information on our Pb-Free strategy and soldering details, please download the ON Semiconductor Soldering and Mounting Techniques Reference Manual, SOLDERRM/D.

NLAS4599

PACKAGE DIMENSIONS

TSOP-6 CASE 318G-02 ISSUE S

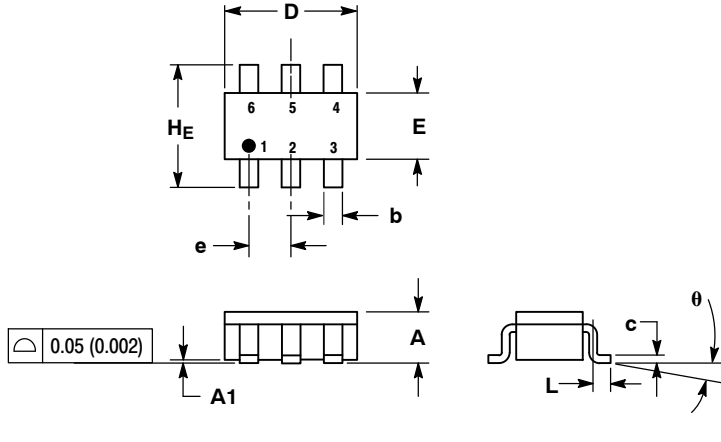

- NOTES:
1. DIMENSIONING AND TOLERANCING PER ANSI Y14.5M, 1982.
 2. CONTROLLING DIMENSION: MILLIMETER.
 3. MAXIMUM LEAD THICKNESS INCLUDES LEAD FINISH THICKNESS. MINIMUM LEAD THICKNESS IS THE MINIMUM THICKNESS OF BASE MATERIAL.
 4. DIMENSIONS A AND B DO NOT INCLUDE MOLD FLASH, PROTRUSIONS, OR GATE BURRS.

DIM	MILLIMETERS			INCHES		
	MIN	NOM	MAX	MIN	NOM	MAX
A	0.90	1.00	1.10	0.035	0.039	0.043
A1	0.01	0.06	0.10	0.001	0.002	0.004
b	0.25	0.38	0.50	0.010	0.014	0.020
c	0.10	0.18	0.26	0.004	0.007	0.010
D	2.90	3.00	3.10	0.114	0.118	0.122
E	1.30	1.50	1.70	0.051	0.059	0.067
e	0.85	0.95	1.05	0.034	0.037	0.041
L	0.20	0.40	0.60	0.008	0.016	0.024
HE	2.50	2.75	3.00	0.099	0.108	0.118
theta	0°	-	10°	0°	-	10°

SOLDERING FOOTPRINT*

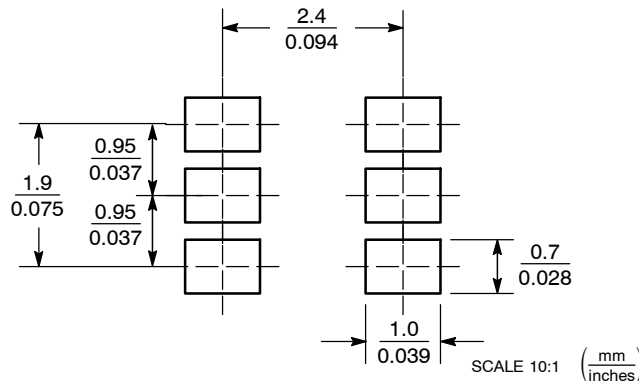

*For additional information on our Pb-Free strategy and soldering details, please download the ON Semiconductor Soldering and Mounting Techniques Reference Manual, SOLDERRM/D.

ON Semiconductor and are registered trademarks of Semiconductor Components Industries, LLC (SCILLC). SCILLC reserves the right to make changes without further notice to any products herein. SCILLC makes no warranty, representation or guarantee regarding the suitability of its products for any particular purpose, nor does SCILLC assume any liability arising out of the application or use of any product or circuit, and specifically disclaims any and all liability, including without limitation special, consequential or incidental damages. "Typical" parameters which may be provided in SCILLC data sheets and/or specifications can and do vary in different applications and actual performance may vary over time. All operating parameters, including "Typicals" must be validated for each customer application by customer's technical experts. SCILLC does not convey any license under its patent rights nor the rights of others. SCILLC products are not designed, intended, or authorized for use as components in systems intended for surgical implant into the body, or other applications intended to support or sustain life, or for any other application in which the failure of the SCILLC product could create a situation where personal injury or death may occur. Should Buyer purchase or use SCILLC products for any such unintended or unauthorized application, Buyer shall indemnify and hold SCILLC and its officers, employees, subsidiaries, affiliates, and distributors harmless against all claims, costs, damages, and expenses, and reasonable attorney fees arising out of, directly or indirectly, any claim of personal injury or death associated with such unintended or unauthorized use, even if such claim alleges that SCILLC was negligent regarding the design or manufacture of the part. SCILLC is an Equal Opportunity/Affirmative Action Employer. This literature is subject to all applicable copyright laws and is not for resale in any manner.

PUBLICATION ORDERING INFORMATION

LITERATURE FULFILLMENT:
Literature Distribution Center for ON Semiconductor
P.O. Box 5163, Denver, Colorado 80217 USA
Phone: 303-675-2175 or 800-344-3860 Toll Free USA/Canada
Fax: 303-675-2176 or 800-344-3867 Toll Free USA/Canada
Email: orderlit@onsemi.com

N. American Technical Support: 800-282-9855 Toll Free
USA/Canada
Europe, Middle East and Africa Technical Support:
Phone: 421 33 790 2910
Japan Customer Focus Center
Phone: 81-3-5773-3850

ON Semiconductor Website: www.onsemi.com
Order Literature: <http://www.onsemi.com/orderlit>

For additional information, please contact your local Sales Representative