

SMCJ-HR Series

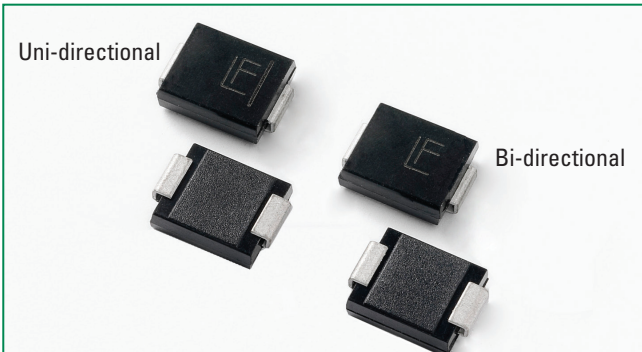

Agency Approvals

AGENCY	AGENCY FILE NUMBER
	E230531

Maximum Ratings and Thermal Characteristics (T_A=25°C unless otherwise noted)

Parameter	Symbol	Value	Unit
Peak Pulse Power Dissipation at T _A =25°C by 10/1000µs waveform (Fig.1)(Note 1), (Note 2)	P _{PPM}	1500	W
Power Dissipation on infinite heat sink at T _A =50°C	P _{M(AV)}	6.5	W
Peak Forward Surge Current, 8.3ms Single Half Sine Wave (Note 3)	I _{FSM}	200	A
Maximum Instantaneous Forward Voltage at 100A for Unidirectional only	V _F	3.5	V
Operating Junction and Storage Temperature Range	T _J , T _{STG}	-65 to 150	°C
Typical Thermal Resistance Junction to Lead	R _{wJL}	15	°C/W
Typical Thermal Resistance Junction to Ambient	R _{wJA}	75	°C/W

- Notes:**
- Non-repetitive current pulse, per Fig. 3 and derated above T_A = 25°C per Fig. 2.
 - Mounted on copper pad area of 0.31x0.31" (8.0 x 8.0mm) to each terminal.
 - Measured on 8.3ms single half sine wave or equivalent square wave for unidirectional device only, duty cycle=4 per minute maximum.

Functional Diagram

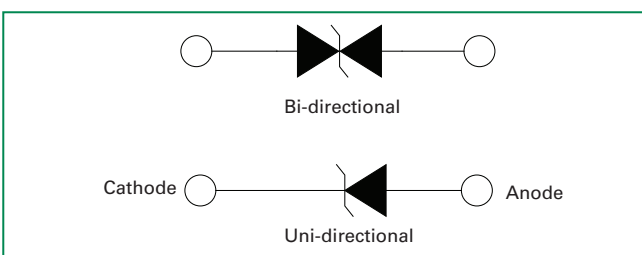

Description

The SMCJ-HR High Reliability series is designed specifically to protect sensitive electronic equipment from voltage transients induced by lightning and other transient voltage events.

Features

- 1500W peak pulse power capability at 10/1000µs waveform, repetition rate (duty cycles):0.01%
- For surface mounted applications in order to optimize board space
- Low profile package
- Built-in strain relief
- V_{BR} @ T_J = V_{BR} @ 25°C x (1 + α T x (T_J - 25)) (α T: Temperature Coefficient, typical value is 0.1%)
- Glass passivated chip junction
- Fast response time: typically less than 1.0ps from 0V to BV min
- Excellent clamping capability
- Low incremental surge resistance
- Typical I_R less than 1µA above 12V
- High Temperature soldering guaranteed: 260°C/40 seconds at terminals
- Plastic package is flammability rated V-0 per UL 94
- Meet MSL level1, per J-STD-020, LF maximum peak of 260°C
- Matte tin lead-free plated
- Halogen free and RoHS compliant
- Pb-free E3 means 2nd level interconnect is Pb-free and the terminal finish material is tin(Sn) (IPC/JEDEC J-STD-609A.01)

Applications

TVS devices are ideal for the protection of I/O Interfaces, V_{CC} bus and other vulnerable circuits used in Telecom, Computer, Industrial and Consumer electronic applications.

Electrical Characteristics

Part Number (Uni)	Part Number (Bi)	Marking		Reverse Stand off Voltage V_R (Volts)	Breakdown Voltage V_{BR} (Volts) @ I_T		Test Current I_T (mA)	Maximum Clamping Voltage V_C @ I_{PP} (V)	Maximum Peak Pulse Current I_{PP} (A)	Maximum Reverse Leakage I_R @ V_R (μ A)	Agency Approval 
		UNI	BI		MIN	MAX					
SMCJ5.0A-HR	SMCJ5.0CA-HR	GDE	BDE	5.0	6.40	7.00	10	9.2	163.0	800	X
SMCJ6.0A-HR	SMCJ6.0CA-HR	GDG	BDG	6.0	6.67	7.37	10	10.3	145.7	800	X
SMCJ6.5A-HR	SMCJ6.5CA-HR	GDK	BDK	6.5	7.22	7.98	10	11.2	134.0	500	X
SMCJ7.0A-HR	SMCJ7.0CA-HR	GDM	BDM	7.0	7.78	8.60	10	12.0	125.0	200	X
SMCJ7.5A-HR	SMCJ7.5CA-HR	GDP	BDP	7.5	8.33	9.21	1	12.9	116.3	100	X
SMCJ8.0A-HR	SMCJ8.0CA-HR	GDR	BDR	8.0	8.89	9.83	1	13.6	110.3	50	X
SMCJ8.5A-HR	SMCJ8.5CA-HR	GDT	BDT	8.5	9.44	10.40	1	14.4	104.2	20	X
SMCJ9.0A-HR	SMCJ9.0CA-HR	GDV	BDV	9.0	10.00	11.10	1	15.4	97.4	10	X
SMCJ10A-HR	SMCJ10CA-HR	GDX	BDX	10.0	11.10	12.30	1	17.0	88.3	5	X
SMCJ11A-HR	SMCJ11CA-HR	GDZ	BDZ	11.0	12.20	13.50	1	18.2	82.5	1	X
SMCJ12A-HR	SMCJ12CA-HR	GEE	BEE	12.0	13.30	14.70	1	19.9	75.4	1	X
SMCJ13A-HR	SMCJ13CA-HR	GEG	BEG	13.0	14.40	15.90	1	21.5	69.8	1	X
SMCJ14A-HR	SMCJ14CA-HR	GEK	BEK	14.0	15.60	17.20	1	23.2	64.7	1	X
SMCJ15A-HR	SMCJ15CA-HR	GEM	BEM	15.0	16.70	18.50	1	24.4	61.5	1	X
SMCJ16A-HR	SMCJ16CA-HR	GEP	BEP	16.0	17.80	19.70	1	26.0	57.7	1	X
SMCJ17A-HR	SMCJ17CA-HR	GER	BER	17.0	18.90	20.90	1	27.6	54.4	1	X
SMCJ18A-HR	SMCJ18CA-HR	GET	BET	18.0	20.00	22.10	1	29.2	51.4	1	X
SMCJ20A-HR	SMCJ20CA-HR	GEV	BEV	20.0	22.20	24.50	1	32.4	46.3	1	X
SMCJ22A-HR	SMCJ22CA-HR	GEX	BEX	22.0	24.40	26.90	1	35.5	42.3	1	X
SMCJ24A-HR	SMCJ24CA-HR	GEZ	BEZ	24.0	26.70	29.50	1	38.9	38.6	1	X
SMCJ26A-HR	SMCJ26CA-HR	GFE	BFE	26.0	28.90	31.90	1	42.1	35.7	1	X
SMCJ28A-HR	SMCJ28CA-HR	GFG	BFG	28.0	31.10	34.40	1	45.4	33.1	1	X
SMCJ30A-HR	SMCJ30CA-HR	GFK	BFK	30.0	33.30	36.80	1	48.4	31.0	1	X
SMCJ33A-HR	SMCJ33CA-HR	GFM	BFM	33.0	36.70	40.60	1	53.3	28.2	1	X
SMCJ36A-HR	SMCJ36CA-HR	GFP	BFP	36.0	40.00	44.20	1	58.1	25.9	1	X
SMCJ40A-HR	SMCJ40CA-HR	GFR	BFR	40.0	44.40	49.10	1	64.5	23.3	1	X
SMCJ43A-HR	SMCJ43CA-HR	GFT	BFT	43.0	47.80	52.80	1	69.4	21.7	1	X
SMCJ45A-HR	SMCJ45CA-HR	GFV	BFV	45.0	50.00	55.30	1	72.7	20.6	1	X
SMCJ48A-HR	SMCJ48CA-HR	GFX	BFX	48.0	53.30	58.90	1	77.4	19.4	1	X
SMCJ51A-HR	SMCJ51CA-HR	GFZ	BFZ	51.0	56.70	62.70	1	82.4	18.2	1	X
SMCJ54A-HR	SMCJ54CA-HR	GGE	BGE	54.0	60.00	66.30	1	87.1	17.3	1	X
SMCJ58A-HR	SMCJ58CA-HR	GGG	BGG	58.0	64.40	71.20	1	93.6	16.1	1	X
SMCJ60A-HR	SMCJ60CA-HR	GGK	BGK	60.0	66.70	73.70	1	96.8	15.5	1	X
SMCJ64A-HR	SMCJ64CA-HR	GGM	BGM	64.0	71.10	78.60	1	103.0	14.6	1	X
SMCJ70A-HR	SMCJ70CA-HR	GGP	BGP	70.0	77.80	86.00	1	113.0	13.3	1	X
SMCJ75A-HR	SMCJ75CA-HR	GGR	BGR	75.0	83.30	92.10	1	121.0	12.4	1	X
SMCJ78A-HR	SMCJ78CA-HR	GGT	BGT	78.0	86.70	95.80	1	126.0	11.9	1	X
SMCJ85A-HR	SMCJ85CA-HR	GGV	BGV	85.0	94.40	104.00	1	137.0	11.0	1	X
SMCJ90A-HR	SMCJ90CA-HR	GGX	BGX	90.0	100.00	111.00	1	146.0	10.3	1	X
SMCJ100A-HR	SMCJ100CA-HR	GGZ	BGZ	100.0	111.00	123.00	1	162.0	9.3	1	X
SMCJ110A-HR	SMCJ110CA-HR	GHE	BHE	110.0	122.00	135.00	1	177.0	8.5	1	X
SMCJ120A-HR	SMCJ120CA-HR	GHG	BHG	120.0	133.00	147.00	1	193.0	7.8	1	X
SMCJ130A-HR	SMCJ130CA-HR	GHK	BHK	130.0	144.00	159.00	1	209.0	7.2	1	X
SMCJ150A-HR	SMCJ150CA-HR	GHM	BHM	150.0	167.00	185.00	1	243.0	6.2	1	X
SMCJ160A-HR	SMCJ160CA-HR	GHP	BHP	160.0	178.00	197.00	1	259.0	5.8	1	X
SMCJ170A-HR	SMCJ170CA-HR	GHR	BHR	170.0	189.00	209.00	1	275.0	5.5	1	X

Note:

1. For bidirectional type having V_R of 10 volts and less, the I_R limit is double.
2. Each lot of parts will pass group B test requirement.

Screen Process

100% vision inspection	MIL-STD-750 method 2074
100%High Temperature Storage Life (168hrs,175C)	MIL-STD-750 method 1031
100% X-RAY inspection	MIL-STD-750 method 2076
100% Temperature cycle test (-55-150C, 20 cycles, dwell time 15 min)	MIL-STD-750 method 1051
100% Reflow (2X)	JEDEC J-STD-020
100% surge test (2x)	MIL-STD-750 method 4066
100% HTRB(150C, Bias=VR(80% breakdown voltage), 96hrs),for Bi-direction products, 96hrs for each direction	MIL-STD-750 method 1038
Final electrical test(100% 3 sigma limit, 100% dynamic test and PAT limit)	MIL-STD-750 method 4016.4021.4011

Note: Up-screen program can be specified by customer's request via contacting Littelfuse service

Group B Test Requirement

Screen	Method	Condition	Requirement
Surge test	10/1000 μ s Peak Pulse Waveform	Maximum Clamping Voltage (V_c) @ Peak Pulse Current (I_{pp})	Sample size 45 perform 10x Accept 0 failures
Burn - In (HTRB)	MIL-STD-750, Method 1038.5	Applied Voltage 100% V_R @150°C	Sample size 45 340 hours (680 hours for bi-direction products, each direction 340 hours) Accept 0 failures
Electrical test	--	I_R @ V_R , $V_{(BR)}$ @ I_T	Sample size 45 Accept 0 failures

I-V Curve Characteristics

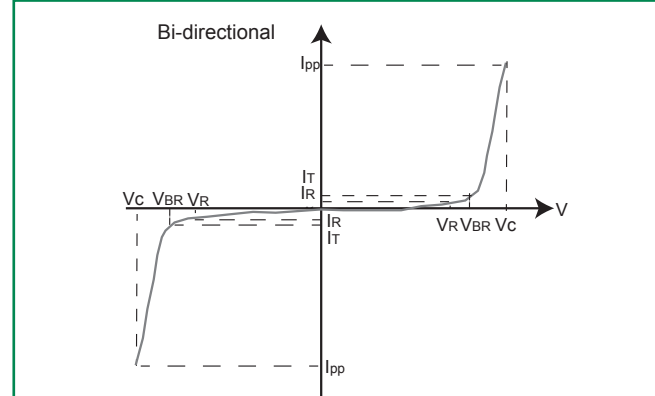
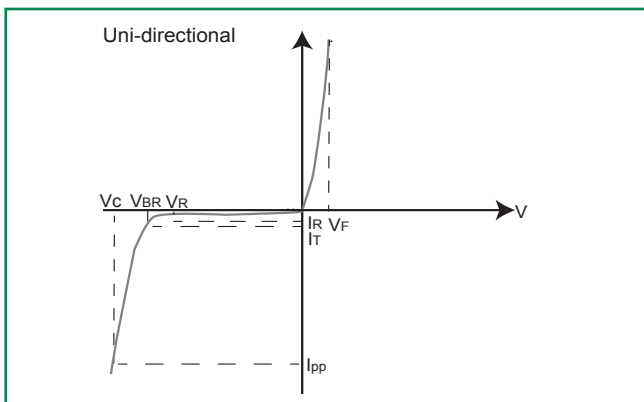

- P_{pp} Peak Pulse Power Dissipation** – Max power dissipation
- V_R Stand-off Voltage** – Maximum voltage that can be applied to the TVS without operation
- V_{BR} Breakdown Voltage** – Maximum voltage that flows through the TVS at a specified test current (I_T)
- V_C Clamping Voltage** – Peak voltage measured across the suppressor at a specified I_{pp} (peak impulse current)
- I_R Reverse Leakage Current** – Current measured at V_R
- V_F Forward Voltage Drop for Uni-directional**

Ratings and Characteristic Curves ($T_A=25^\circ\text{C}$ unless otherwise noted)

Figure 1 - TVS Transients Clamping Waveform

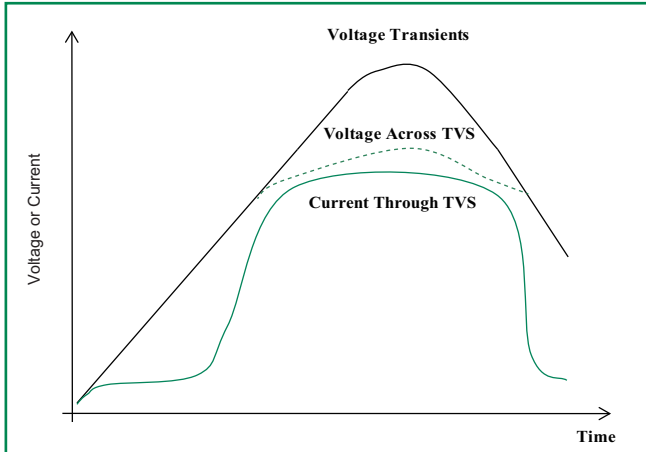

Figure 2 - Peak Pulse Power Rating

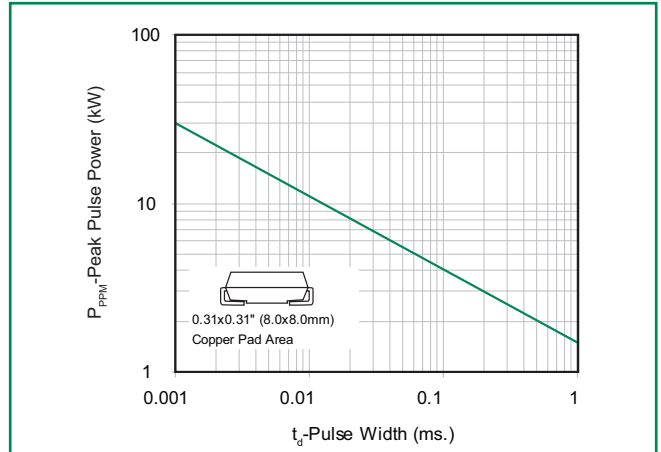

Figure 3 - Pulse Derating Curve

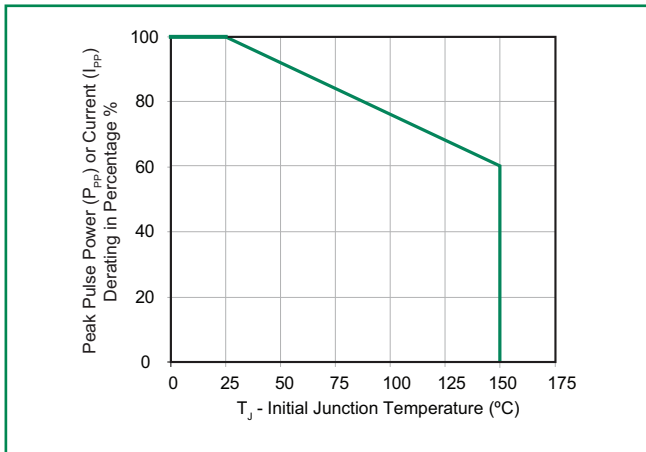

Figure 4 - Pulse Waveform

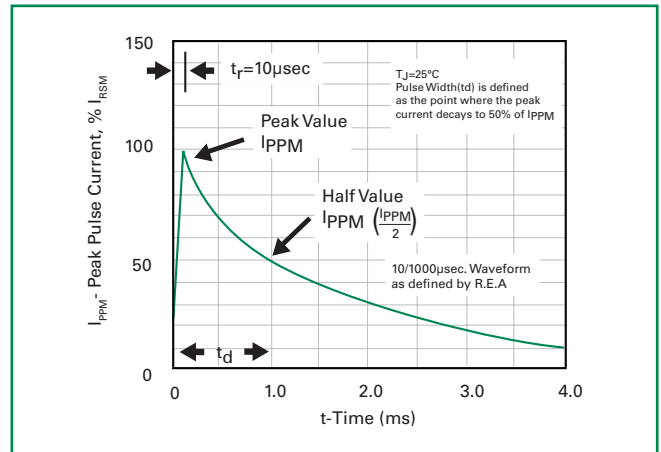

Figure 5 - Typical Junction Capacitance

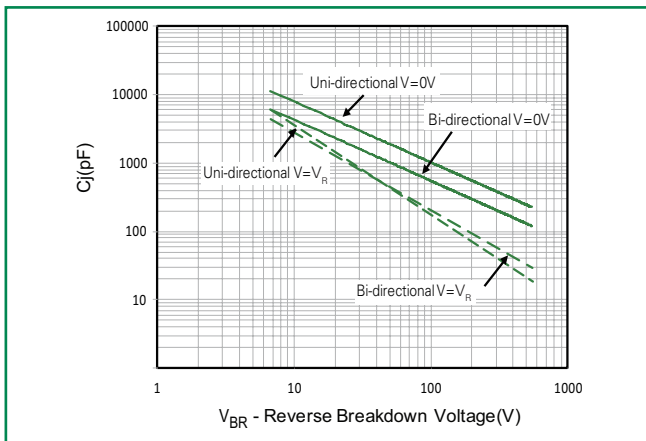

Figure 6 - Steady State Power Dissipation Derating Curve

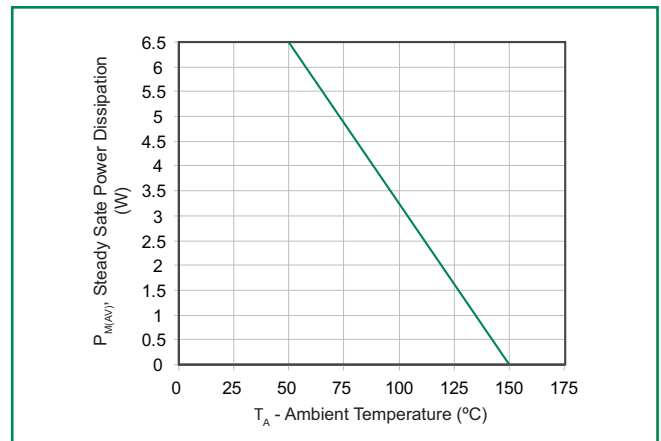
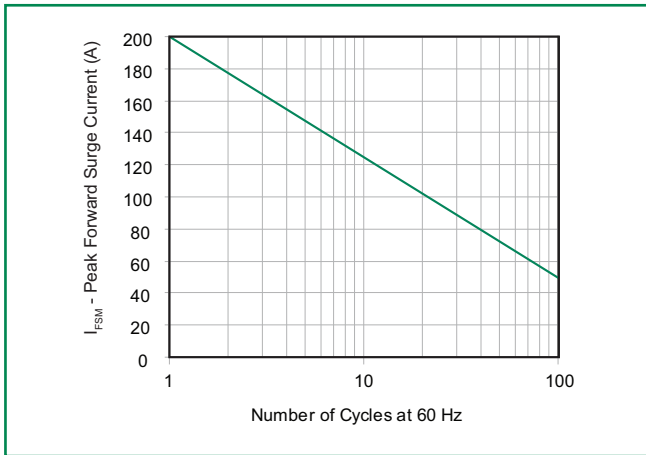
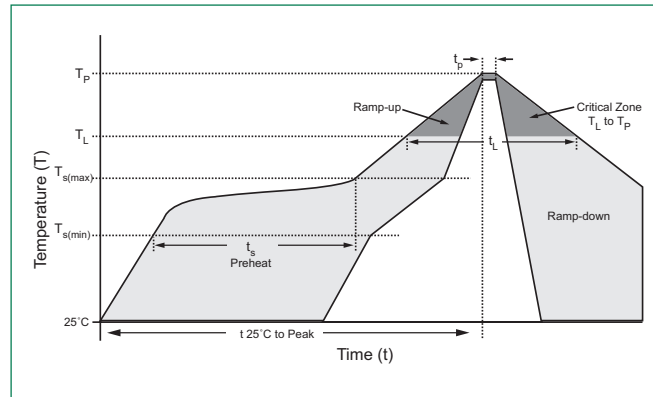

Figure 7 - Maximum Non-Repetitive Peak Forward Surge Current Uni-Directional Only



Soldering Parameters

Reflow Condition		Lead-free assembly
Pre Heat	- Temperature Min ($T_{s(min)}$)	150°C
	- Temperature Max ($T_{s(max)}$)	200°C
	- Time (min to max) (t_s)	60 – 180 secs
Average ramp up rate (Liquidus Temp (T_L) to peak)		3°C/second max
$T_{s(max)}$ to T_L - Ramp-up Rate		3°C/second max
Reflow	- Temperature (T_L) (Liquidus)	217°C
	- Time (min to max) (t_s)	60 – 150 seconds
Peak Temperature (T_p)		260 ^{+0/-5} °C
Time within 5°C of actual peak Temperature (t_p)		20 – 40 seconds
Ramp-down Rate		6°C/second max
Time 25°C to peak Temperature (T_p)		8 minutes Max.
Do not exceed		260°C



Physical Specifications

Weight	0.007 ounce, 0.21 grams
Case	JEDEC DO214AB. Molded plastic body over glass passivated junction
Polarity	Color band denotes positive end (cathode) except Bidirectional.
Terminal	Matte Tin-plated leads, Solderable per JESD22-B102

Environmental Specifications

High Temp. Storage	JESD22-A103
HTRB	JESD22-A108
Temperature Cycling	JESD22-A104
MSL	JEDEC-J-STD-020, Level 1
H3TRB	JESD22-A101
RSH	JESD22-A111

Dimensions

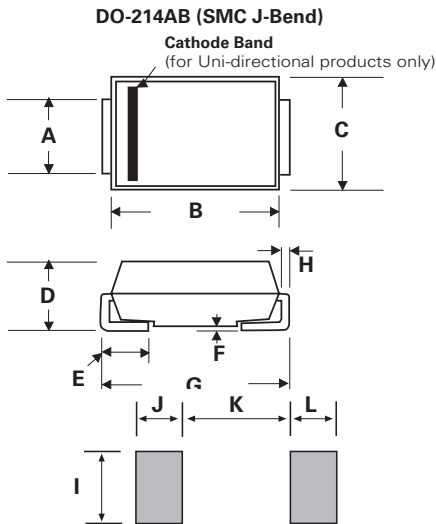

Dimensions	Inches		Millimeters	
	Min	Max	Min	Max
A	0.114	0.126	2.900	3.200
B	0.260	0.280	6.600	7.110
C	0.220	0.245	5.590	6.220
D	0.079	0.103	2.060	2.620
E	0.030	0.060	0.760	1.520
F	0.002	0.008	0.051	0.203
G	0.305	0.320	7.750	8.130
H	0.006	0.012	0.152	0.305
I	0.129	-	3.300	-
J	0.094	-	2.400	-
K	-	0.165	-	4.200
L	0.094	-	2.400	-

Part Numbering System

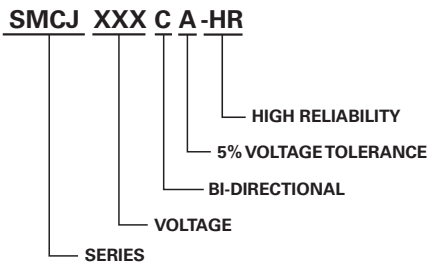

Part Marking System

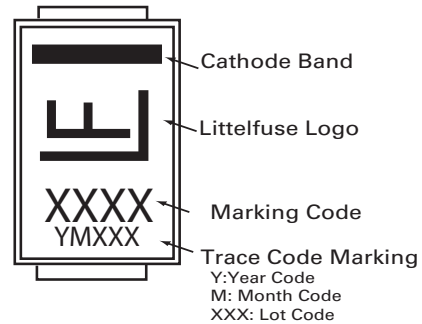

Packaging

Part number	Component Package	Quantity	Packaging Option	Packaging Specification
SMCJxxxXX-HR	DO-214AB	500	Tape & Reel – 16mm tape/7" reel	EIA STD RS-481

Tape and Reel Specification

