



THIS INFORMATION IS CONFIDENTIAL AND PROPRIETARY TO CW INDUSTRIES INCORPORATED AND ITS AFFILIATES. IT MAY NOT BE DISCLOSED TO ANYONE, OTHER THAN CW INDUSTRIES PERSONNEL, WITHOUT WRITTEN AUTHORIZATION FROM CW INDUSTRIES INCORPORATED, SOUTHAMPTON, PENNSYLVANIA USA.

Rating	16(4)A 250V AC   US		Mounting Hole 	Circuit 
	Contact Resistance	50m ohm Max.		
	Insulation Resistance	DC 500V 100M ohm Min.		
	Dielectric Strength	AC 1500V 1 minute		
	Switch Function	4P DPST ON-OFF		
	Operation Temp.	0° C ~ 85° C		

MATERIAL:

Frame: Nylon 6/6, Black
 UL Flame: 94-V0
 Lever: Metal
 Terminal: Copper Alloy

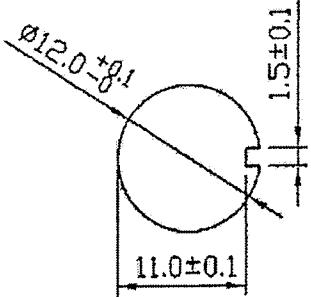
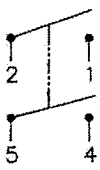
Water proof and Dust Proof
 to fit IP-56

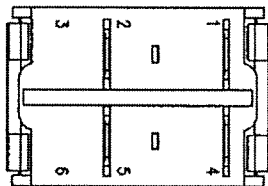
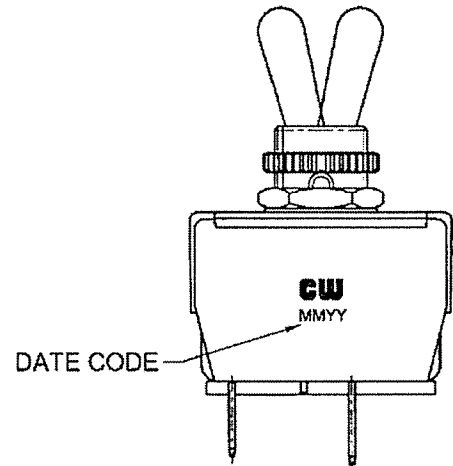
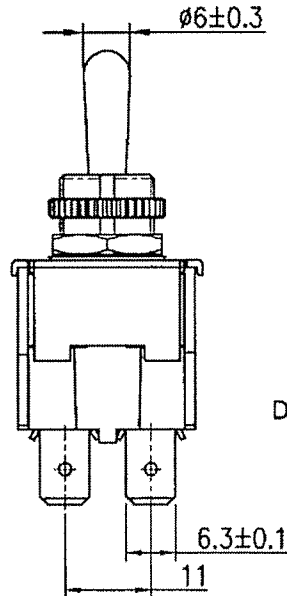
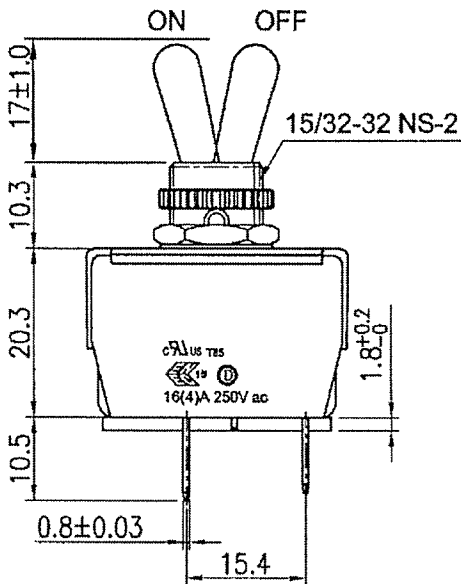
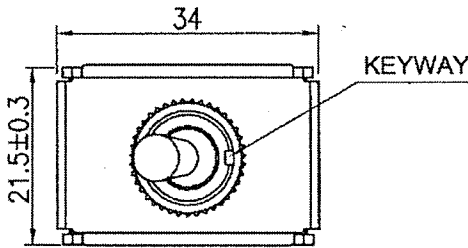

Tolerances Unless Otherwise Specified +/-0.5.

RoHS Compliant

1 Updated material notes.

CW INDUSTRIES
 Southampton, Pa. 18966
 Tel 215.355.7080/www.cwind.com

Date Drawn: 8/09/12

Rev. 1

Unit: mm

Checked By: *G. Gold*

Title:
TOGGLE SWITCH

CW P/N:
GTS448F101AHR