

SPECIFICATION

PATENT PENDING

- Part No : **MFX3.07.0150C**
- Product Name : NB-IoT / CAT M1 Wide Band Flex Antenna
698MHz - 3000 MHz
- Features : Patent Pending
Ground Plane Independent
NB-IoT / CAT M1 Bands
698-3000 MHz
>45% Efficiency on All bands
5 dBi Peak Gain
96*21*0.2 mm size
Φ1.37mm Cable, IPEX MHFI (U.FL Compatible)
RoHS Compliant



1. Introduction

The patent pending MFX3 ultra-wideband flexible antenna has been designed for NB-IoT / CAT M1 applications to provide highest efficiency and covers all working frequencies in the 698-3000MHz spectrum, covering all Cellular, 2.4GHz Wi-Fi, ISM and AGPS. The antenna is omni-directional, delivered with a flexible body with excellent efficiencies on all bands, ground independent, with cable and connector for easy installation.

NB-IoT / CAT M1 is a low power wide area (LPWA) technology specifically designed for IoT and M2M. NB-IoT / CAT M1 technology offers lower maintenance cost, with greater efficiency and reliability by reducing power consumption and providing deeper penetration compared to standard cellular technologies. It operates on secure mobile networks making it suited to automotive, smart meter, medical and smart city applications.

The MFX3 flexible polymer antenna, at 96*21*0.2mm, is extremely thin, and truly ultra-wideband, with high efficiencies across the bands. It is assembled by a simple “peel and stick” process, attaching securely to non-metal surfaces via 3M adhesive. It enables designers to use only one antenna that covers NB-IoT, CAT M1 and all common LTE frequencies.

The MFX3 is made of durable flexible polymer and is designed to be mounted directly onto a plastic or glass cover. It offers a peak gain of 5dBi, an efficiency of more than 45% across the bands and is an ideal choice for any device maker that needs to keep manufacturing costs down over the lifetime of a product. It is ground plane independent and delivered with a cable and connector for easy connecting to the wireless module or customer PCB.

Cables and connectors are customizable. Like all similar antennas, care should be taken to mount the antenna at least 10mm from metal components or surfaces, and ideally 20mm for best radiation efficiency.

2. Specification

ELECTRICAL						
Frequency(MHz)	Band 2		Band 4		Band 12	
	Tx	Rx	Tx	Rx	Tx	Rx
	1850-1910	1930-1990	1710-1755	2110-2155	699-716	729-746
Peak Gain (dBi)	3.07	3.10	3.68	4.51	0.36	0.21
Efficiency (%)	75.98	71.07	68.22	82.01	45.59	44.35
Average Gain (dB)	-1.19	-1.48	-1.66	-0.86	-3.41	-3.53
Radiation Properties	Omni-directional					
Max Input Power (Watts)	5					
Polarization	Linear					
Impedance (Ohms)	50 Ohms					

*Antenna measured on plastic plate of 3 mm thickness.

MECHANICAL	
Dimensions (mm)	96*21*0.2 mm
Material	Flexible Polymer
Connector and Cable	U.FL and 1.37 mm mini coax
Cable Length	150 mm

ENVIRONMENTAL	
Operation Temperature	-40°C to 85°C
Storage Temperature	-40°C to 85°C
Relative Humidity	40% to 95%
RoHS Compliant	Yes

3. Antenna Characteristics

3.1. Return Loss

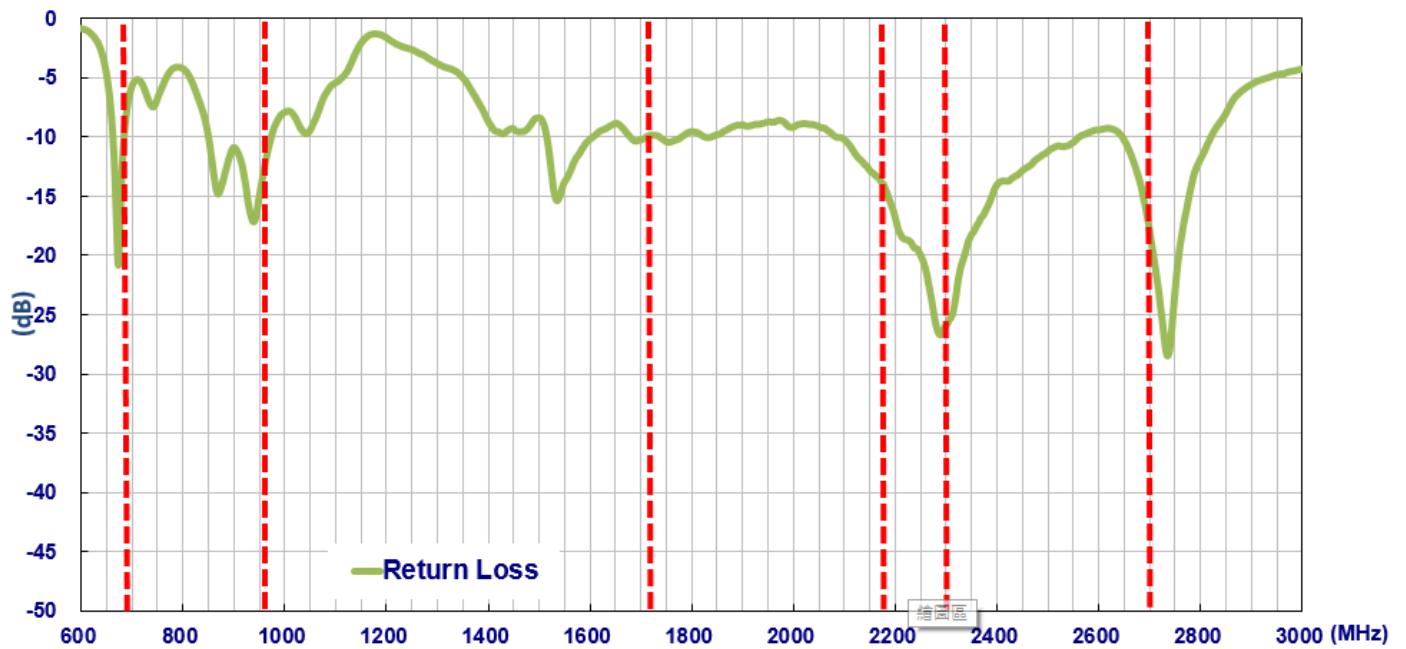

Figure 1. Return loss of MFX3 Antenna.

3.2. Peak Gain

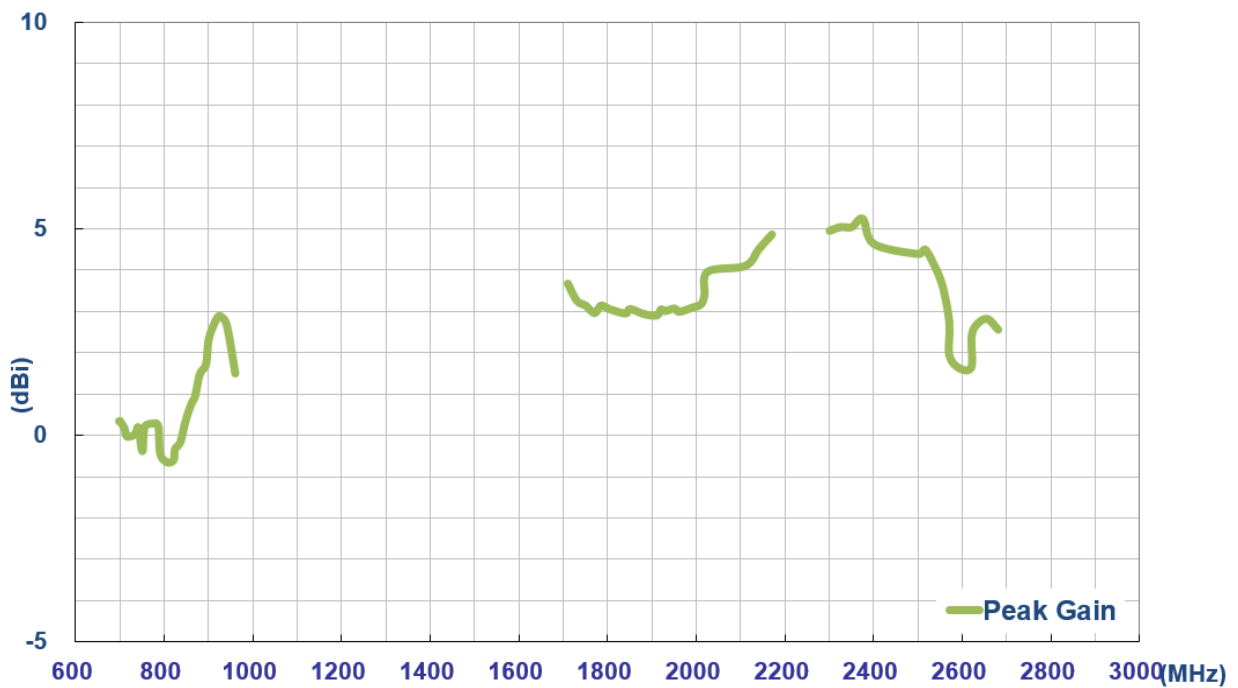

Figure 2. Peak Gain of MFX3 Antenna.

3.3. Efficiency

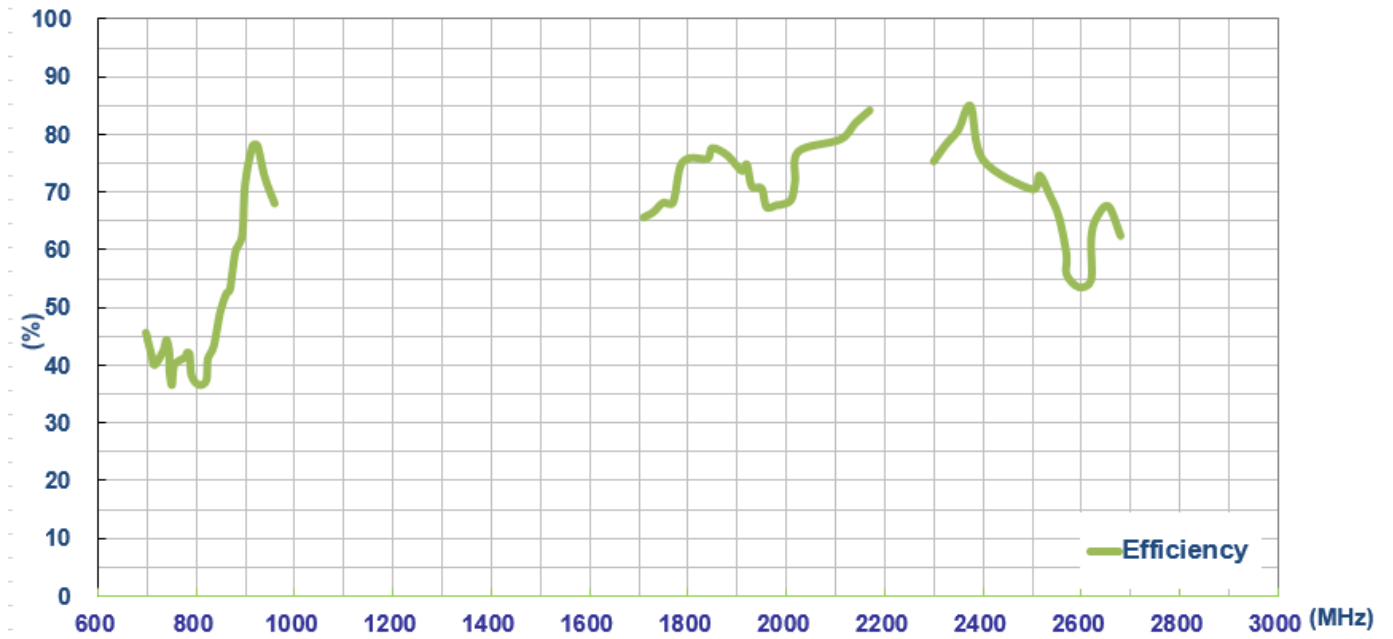

Figure 3. Efficiency of MFX3 Antenna.

3.4. Average Gain

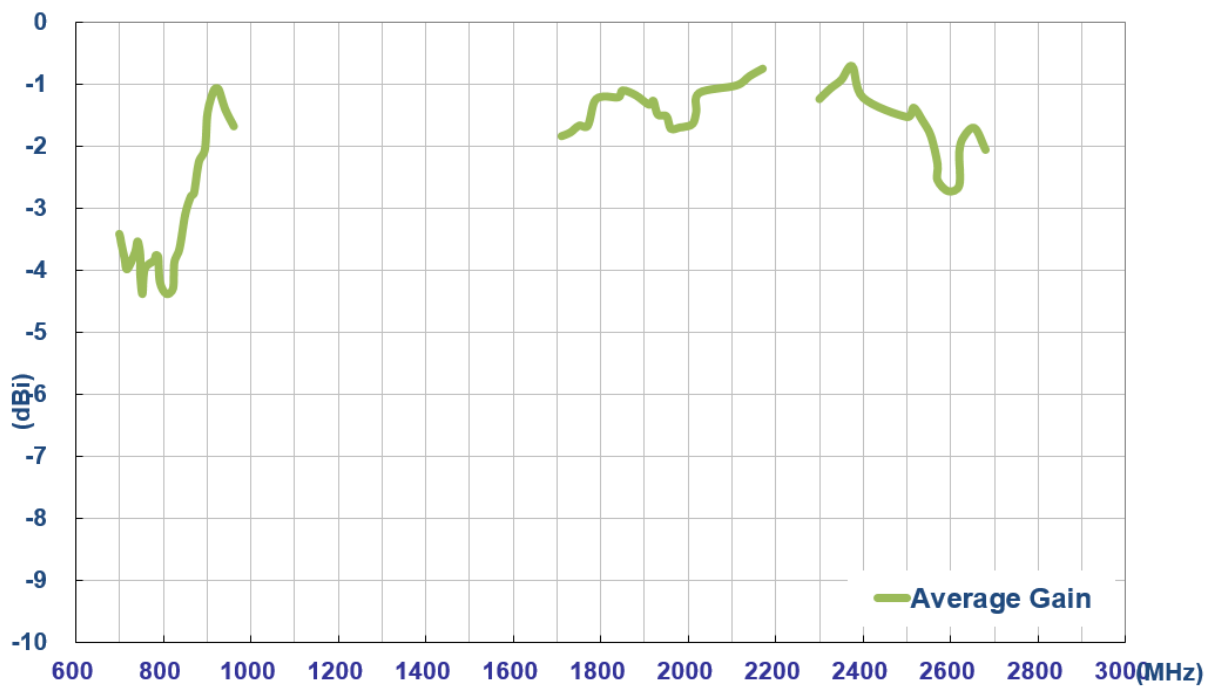
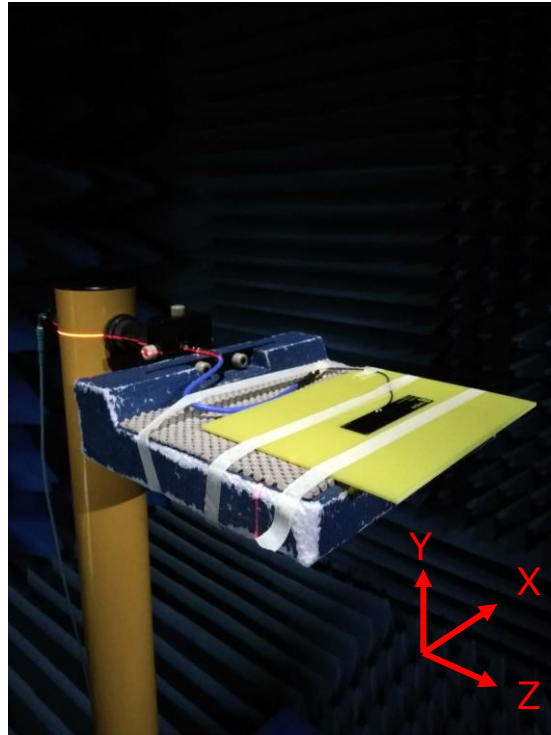

Figure 4. Average Gain of MFX3 Antenna.

4. Radiation Patterns

4.1. Antenna Test Setup



4.2. 2D Radiation Patterns

XY Plane

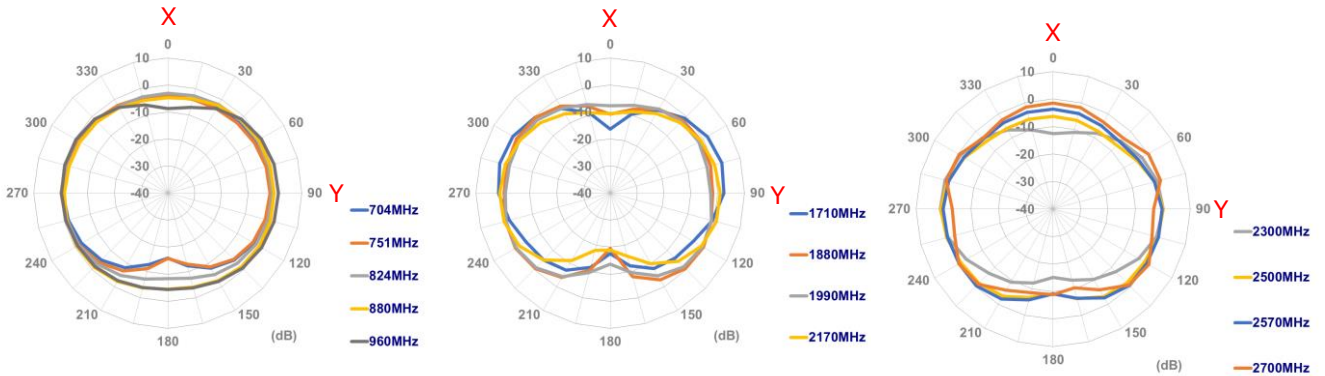

XZ Plane

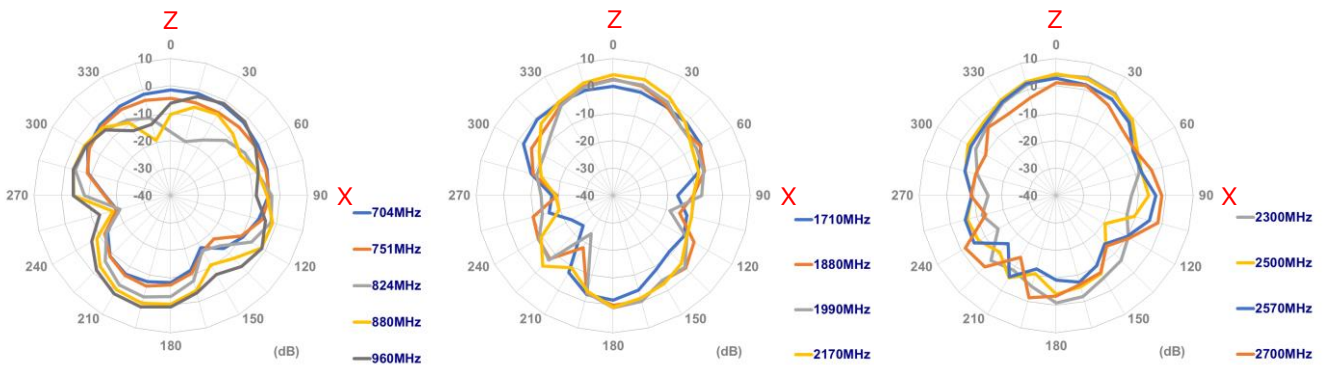

YZ Plane

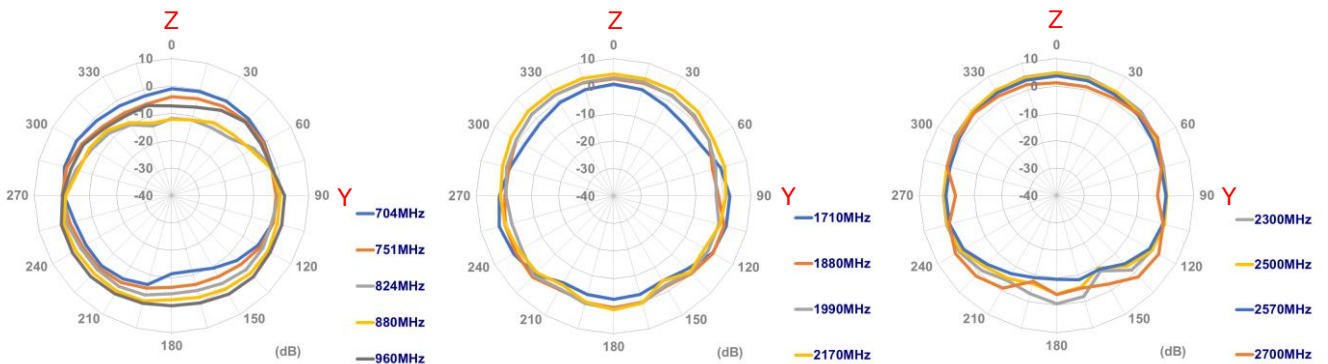

4.3. 3D Radiation Patterns

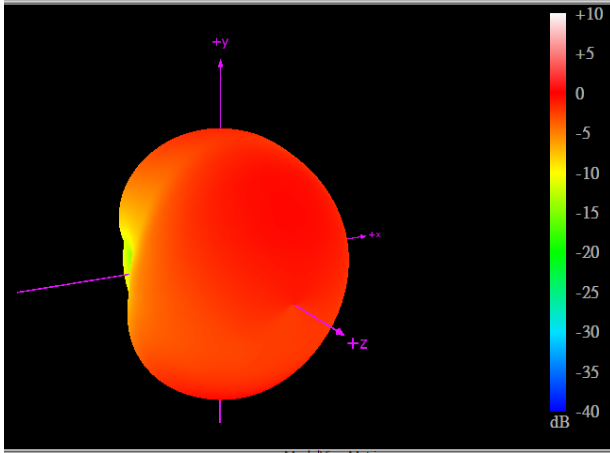

704 MHz

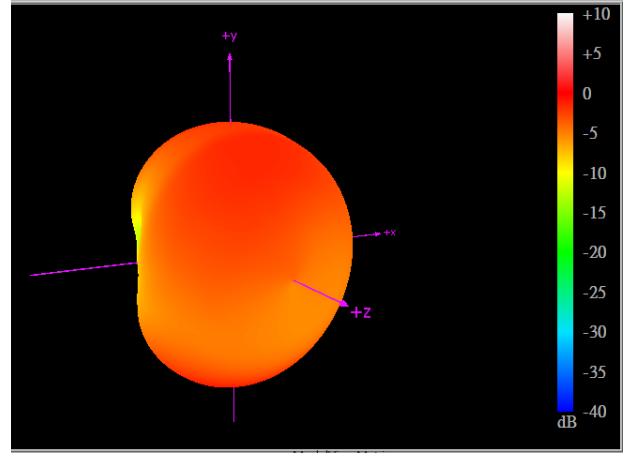

751 MHz

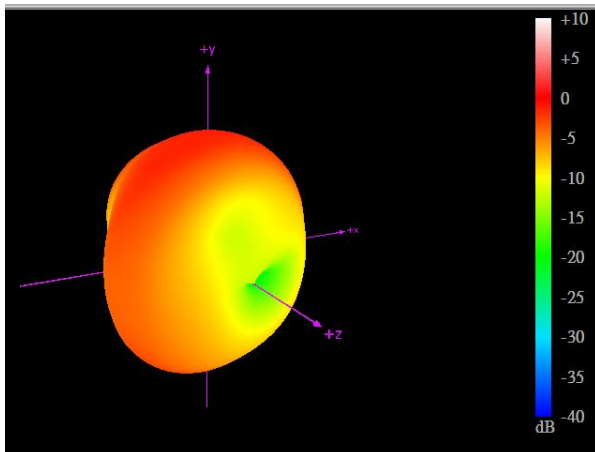

824 MHz

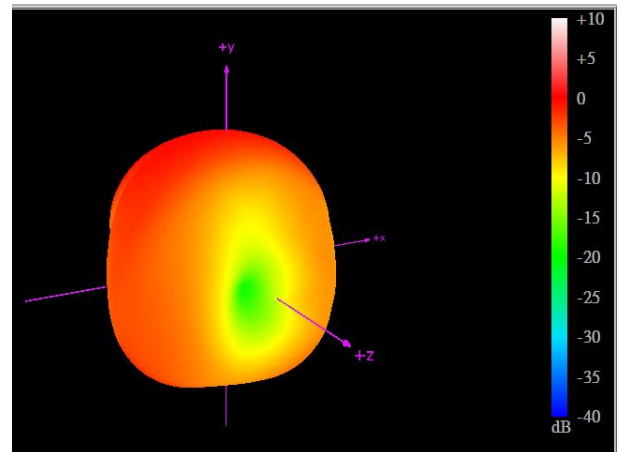

880 MHz

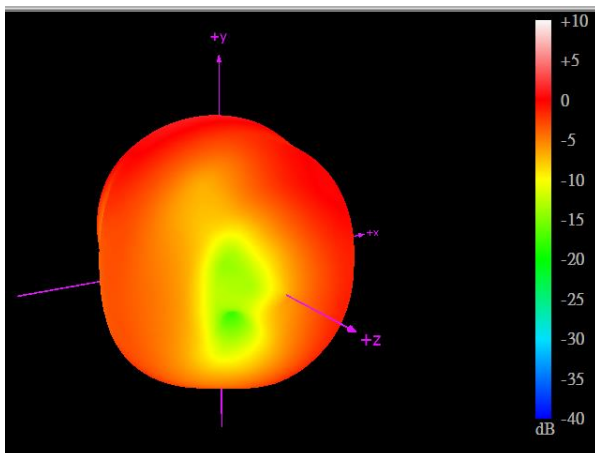

960 MHz

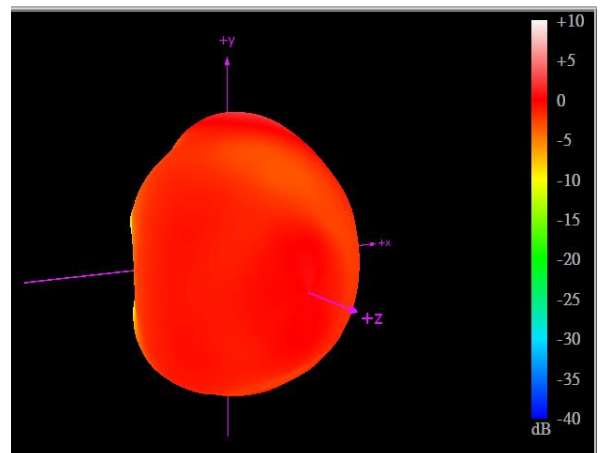

1710 MHz

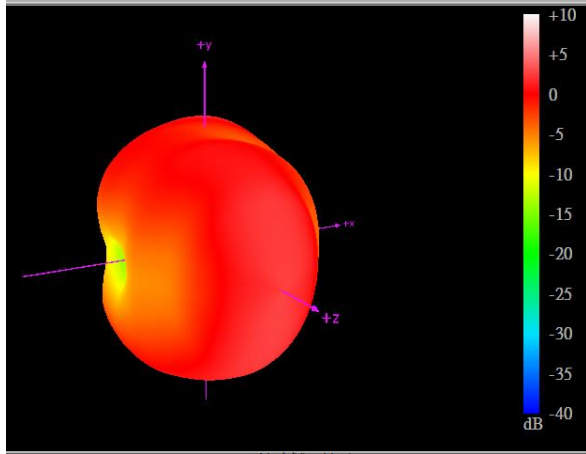

1880 MHz

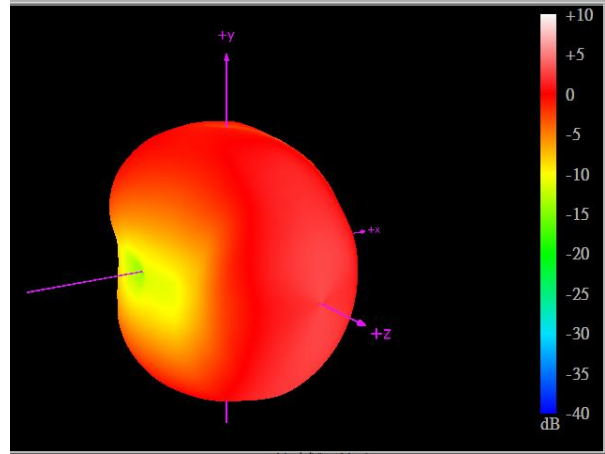

1990 MHz

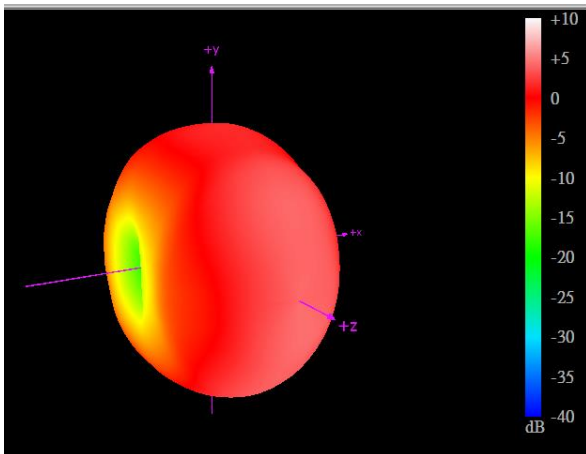

2170 MHz

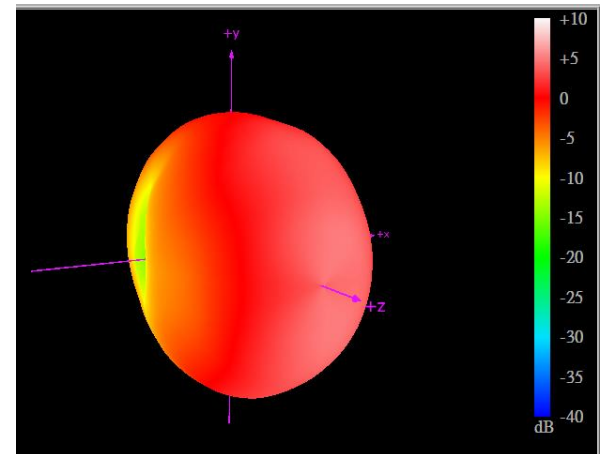

2300 MHz

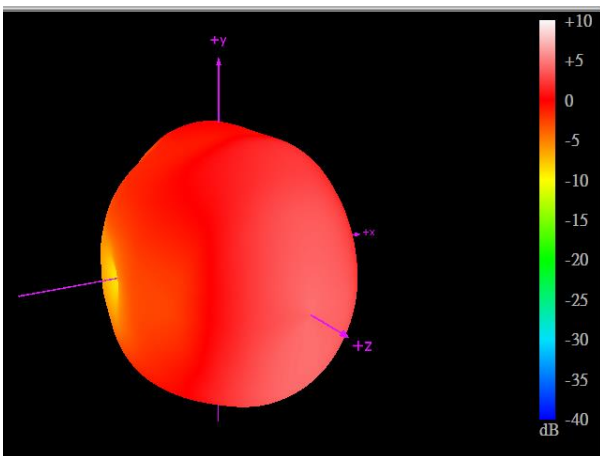

2500 MHz

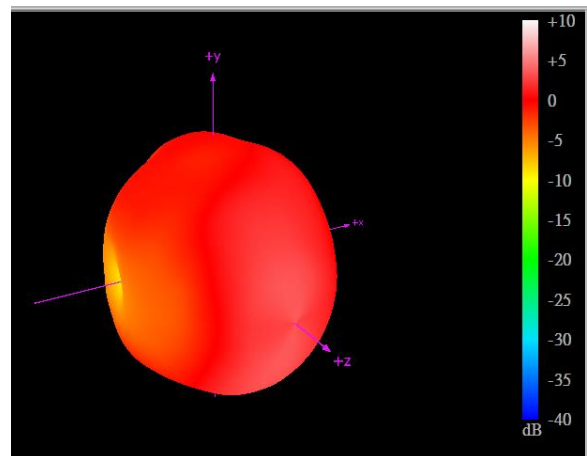

2570 MHz

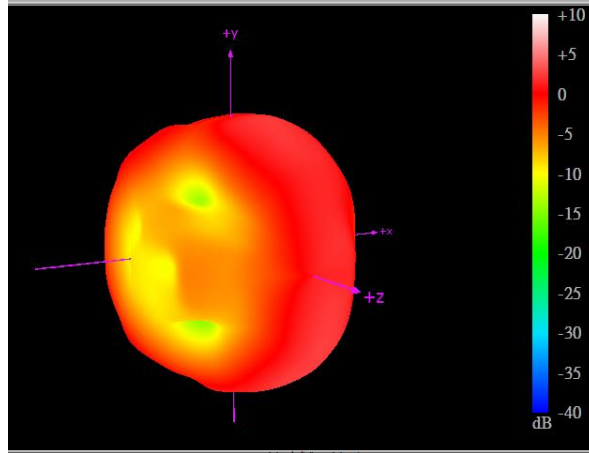

2700 MHz



6. Packaging

100 pcs MFX3 per PE bag
PE Bag Dimensions - 350 x 100mm
Weight - 150g

1000 pcs MFX3 per large PE bag
Large PE Bag Dimensions - 460 x 280mm
Weight - 1500g

4000 pcs MFX3 per carton
Carton Dimensions - 320*250*230 mm
Weight - 6Kg

Pallet Dimensions 1200*1000*1350mm
60 Cartons per Pallet
12 Cartons per layer
5 Layers

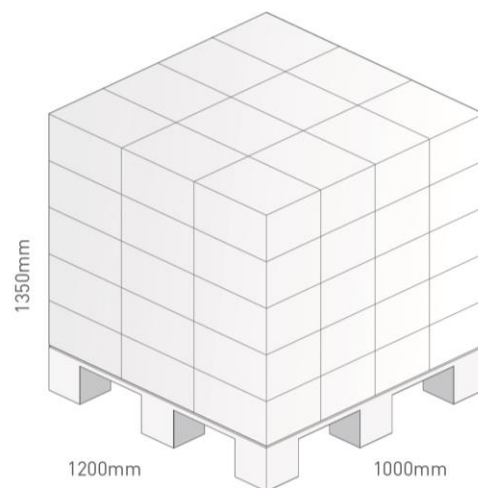
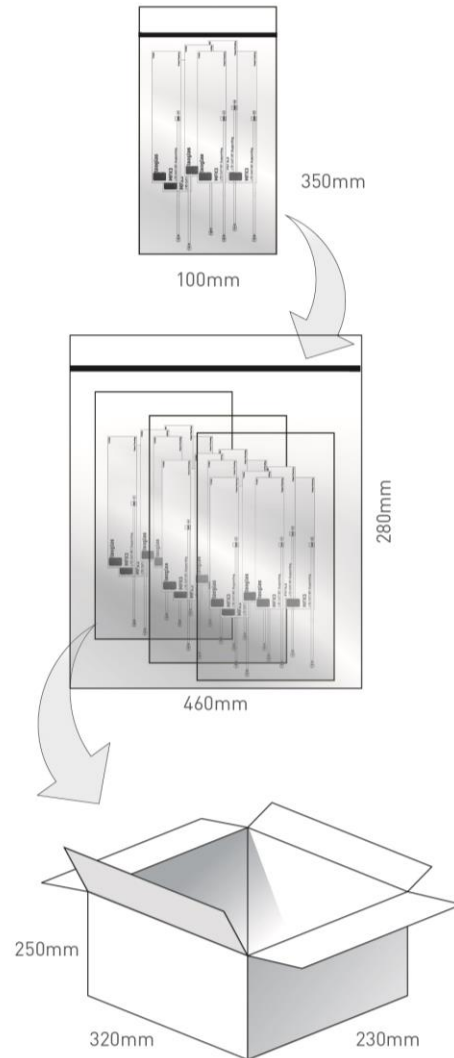



Taoglas makes no warranties based on the accuracy or completeness of the contents of this document and reserves the right to make changes to specifications and product descriptions at any time without notice. Taoglas reserves all rights to this document and the information contained herein.

Reproduction, use or disclosure to third parties without express permission is strictly prohibited.

Copyright © Taoglas Ltd.