



GS01MSAKE



GS01MSC1KE



GS01MSV1KE

- Process compatible—withstands IR and vapor phase reflow soldering and cleaning processes—high temperature materials (UL 94V-0)
- Tin-lead alloy coats all sides of terminals for joint integrity
- Tape and reel packaging available for automated placement
- Splashproof construction—internal actuator seal—epoxy base seal
- Five surface mount terminal styles—.050" and .100" terminal spacing
- SPST and SPDT models available

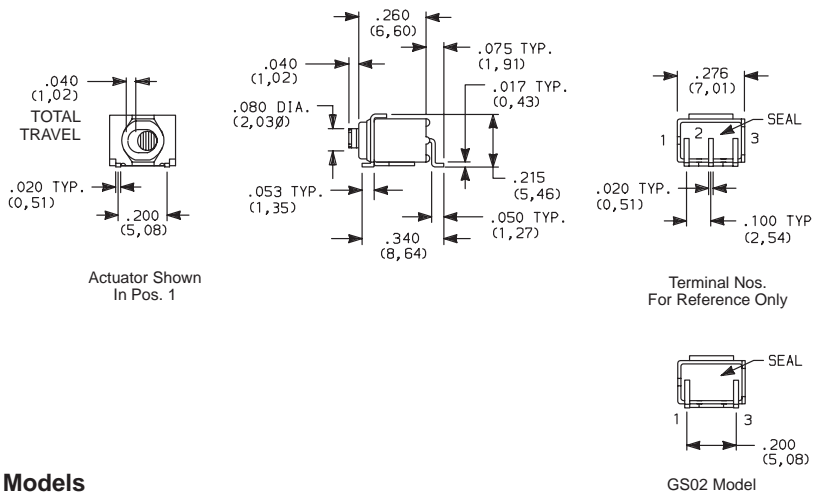

PART NO.	SWITCH FUNCTION	
	POS. 1	POS. 2
GS01MSAKE	ON	ON
Conn. Terms.	2-1	2-3
Schematic		
SPDT		
GS02MSAKE	OFF	ON
Conn. Terms.	OPEN	3-1
Schematic		
SPST		

SPST and SPDT Models With SA Surface Mount Terminals

Part No. Shown: GS01MSAKE

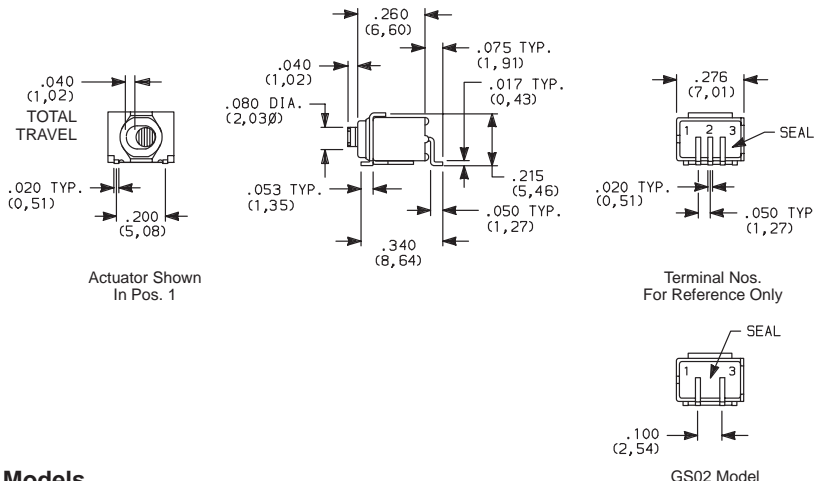

PART NO.	SWITCH FUNCTION	
	POS. 1	POS. 2
GS01MSA1KE	ON	ON
Conn. Terms.	2-1	2-3
Schematic		
SPDT		
GS02MSA1KE	OFF	ON
Conn. Terms.	OPEN	3-1
Schematic		
SPST		

SPST and SPDT Models With SA1 Surface Mount Terminals

Part No. Shown: GS01MSA1KE

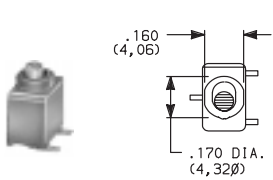

Actuator Shown
In Pos. 1

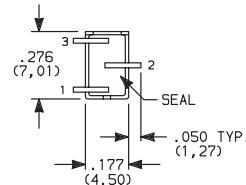
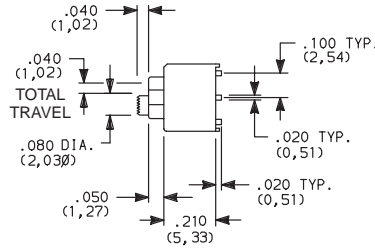

Terminal Nos.
For Reference Only

PART NO.	SWITCH FUNCTION	
	POS. 1	POS. 2
GS01MSCKE	ON	ON
Conn. Terms.	2-1	2-3
Schematic		
SPDT		

**SPDT Models
With SC Surface Mount Terminals**

Part No. Shown: GS01MSCKE

NOTE: Recommended for infrequent use applications only. For increased switch mounting strength, order, SV1 termination style with support bracket (see below).

E

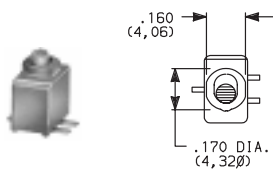

Actuator Shown
In Pos. 1

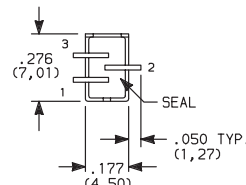
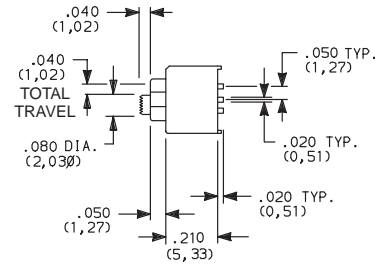

Terminal Nos.
For Reference Only

PART NO.	SWITCH FUNCTION	
	POS. 1	POS. 2
GS01MSC1KE	ON	ON
Conn. Terms.	2-1	2-3
Schematic		
SPDT		

**SPDT Models
With SC1 Surface Mount Terminals**

Part No. Shown: GS01MSC1KE

NOTE: Recommended for infrequent use applications only. For increased switch mounting strength, order, SV1 termination style with support bracket (see below).

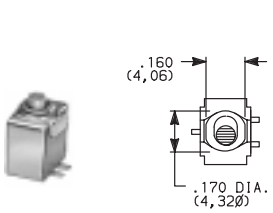

Actuator Shown
In Pos. 1

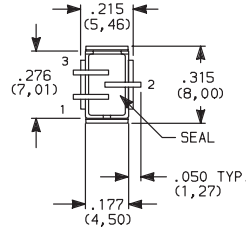
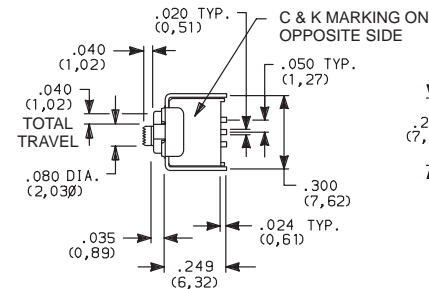

Terminal Nos.
For Reference Only

PART NO.	SWITCH FUNCTION	
	POS. 1	POS. 2
GS01MSV1KE	ON	ON
Conn. Terms.	2-1	2-3
Schematic		
SPDT		

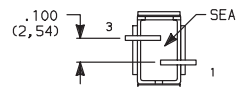

GS02 Model

GS02MSV1KE	OFF	ON
Conn. Terms.	OPEN	3-1
Schematic		
SPST		

**SPST and SPDT Models
With SV1 Surface Mount Terminals**

Part No. Shown: GS01MSV1KE

PC MOUNTING

SA Terminal Style

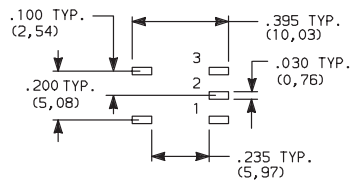

GS02 - omit pad 2.

SA1 Terminal Style

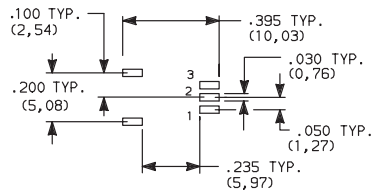

GS02 - omit pad 2.

SC Terminal Style

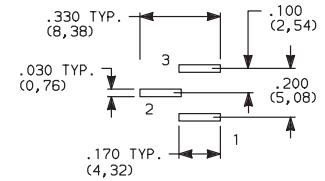

SC1 Terminal Style

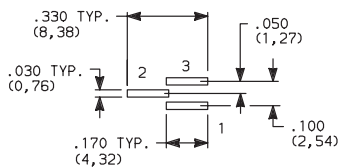

SV1 Terminal Style
GS02 Models

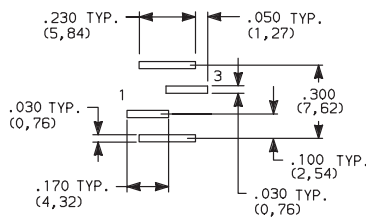

SV1 Terminal Style
GS01 Models

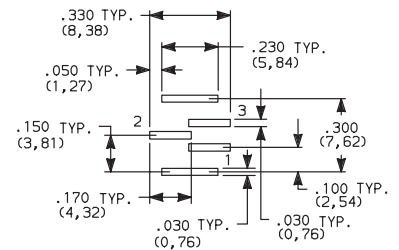

CAUTION: PC mounting layouts and pads as shown are designed to be compatible with the latest equipment and reflow techniques. Care should be taken in the design and location of PC lands to suit individual needs. Orientation relative to reflow direction may significantly impact solder joint integrity.

HOW TO ORDER

Complete part numbers for GS SERIES ULTRA-MINIATURE SURFACE MOUNT SLIDE SWITCHES are shown on pages E-11 and E-12. Switches available on embossed anti-static tape and reels per EIA 481-3, consult factory. GS Series thru-hole models also available, see pages E-9 and E-10.

SPECIFICATIONS

- CONTACT RATING: 0.4 VA max. @ 20 V AC or DC max.
- MECHANICAL & ELECTRICAL LIFE: 40,000 make-and-break cycles at full load.
- CONTACT RESISTANCE: Below 50 milliohms typ. initial @ 2-4 V DC, 100 mA.
- INSULATION RESISTANCE: 10⁹ ohms min.
- DIELECTRIC STRENGTH: 500 V RMS min. @ sea level.
- OPERATING TEMPERATURE: -30°C to 85°C.
- SOLDERABILITY: Per MIL-STD-202F method 208D, or EIA RS-186E method 9 (1 hour steam aging).
- PACKAGING: Some models available on embossed anti-static tape and reels per EIA 481-3. Tape and cover strip are conductive for use near statically sensitive components, consult factory.

NOTE: Specifications and materials listed above are general specifications for switches with standard options. For information on specific and custom switches, consult factory.

MATERIALS

- HOUSING AND BASE: Glass filled nylon 4/6, flame retardant, heat stabilized (UL 94V-0).
- ACTUATOR: Polyetherimide PEI (UL 94V-0), with standard internal seal.
- SWITCH SUPPORT: Brass, tin plated.
- MOVEABLE CONTACTS: Beryllium copper, with gold plate over nickel plate.
- STATIONARY CONTACTS: Copper alloy, with gold plate over nickel plate.
- TERMINALS: Copper alloy, with tin-lead alloy over nickel plate.
- TERMINAL SEAL: Epoxy. All terminals insert molded.