

Surface Mount Oven Stabilized Oscillator DOC Series

CONNOR WINFIELD

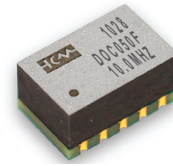

Description:

Connor-Winfield's high stability DOC OCXO / OCVCXO series are exceptionally precise frequency standards, excellent for use in cellular base stations, test equipment, Synchronous Ethernet and VSAT applications.

These true surface mount OCXO / OCVCXO provide frequency stabilities in the range of ± 20 ppb to ± 100 ppb, over the commercial, extended commercial or the industrial temperature range.

The DOC series is available with a CMOS output along with optional Electronic Frequency Tuning (OCVCXO). These oscillators provide outstanding phase noise characteristics that will meet the most stringent requirements.

Features:

- OCXO / OCVCXO
- 3.3 Vdc Operation
- SMT Package
- Frequency Stabilities Available:
 - ± 20 ppb, ± 50 ppb or ± 100 ppb
- Temperature Ranges Available:
 - 0 to 70°C, -20 to 75°, -40 to 85°C or -40 to 70°C
- Low Phase Noise
- LVCMOS Output
- Optional Electronic Frequency Tuning
- RoHS Compliant / Lead Free

2111 Comprehensive Drive
Aurora, Illinois 60505
Phone: 630-851-4722
Fax: 630-851-5040
www.conwin.com

US Headquarters:
630-851-4722
European Headquarters:
+353-61-472221

Package Outline

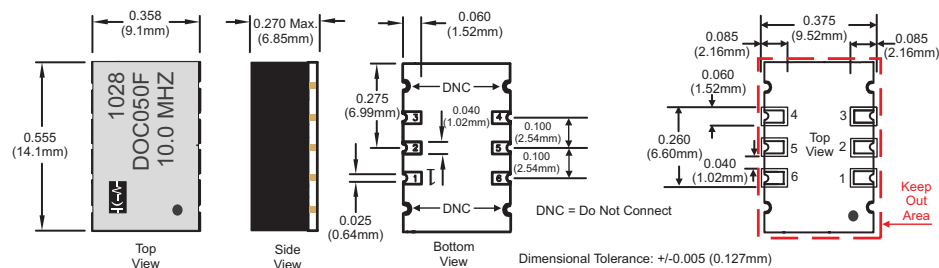

Suggested Pad Layout

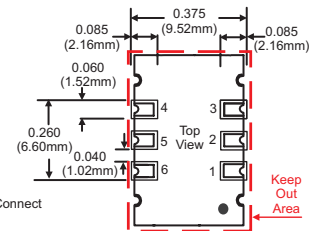

Attention: System Designers please review Application Note AN2093: System Design Information and Printed Circuit Board Layout Guidelines for OCXO Oscillators.
@ www.conwin.com/technologies.html

Pad Connections

- 1: N/C or Vc option
- 2: Do Not Connect
- 3: Ground:
- 4: Output
- 5: Do Not Connect
- 6: Supply Voltage (Vcc)

Ordering Information

DOC	05	0	F	-010.0M
Oscillator Type	Frequency Stability	Temperature Range	Voltage Control Option	Output Frequency
3.3 Vdc LVCMOS Output Surface Mount OCXO	02 = ± 20 ppb 05 = ± 50 ppb 10 = ± 100 ppb 25 = ± 250 ppb	0 = 0 to 70°C 1 = -20 to 75°C 2 = -40 to 85°C 3 = -40 to 70°C	F = OCXO (Fixed Freq.) V = OCVCXO (Voltage Controlled)	Frequency Format -xxx.xM Min.* -xxx.xxxxxM Max*

*Amount of numbers after the decimal point.
M = MHz

Example Part Numbers:

DOC050F-010.0M = 9x14mm package, ± 50 ppb, 0 to 70°C, 3.3 Vdc, CMOS Output, OCXO, Output Frequency 10.0 MHz
DOC022V-020.0M = 9x14mm package, ± 20 ppb, -40 to 85°C, 3.3 Vdc, CMOS Output, OCVCXO, 20.0 MHz



Bulletin **Cx207**
Page **1 of 4**
Revision **16**
Date **19 Nov 2012**



Absolute Maximum Ratings

Parameter	Minimum	Nominal	Maximum	Units	Notes
Storage Temperature	-55	-	125	°C	
Supply Voltage - 3.3 Vdc (Vcc)	-0.5	-	4.5	Vdc	
Control Voltage (Vc)	-0.5	-	Vcc+0.5	Vdc	

Operating Specifications

Parameter	Minimum	Nominal	Maximum	Units	Notes
Center Frequency: (Fo)	10, 12.8, 19.44, 20, 25, 38.88, 40, 50 or 80			MHz	
Frequency Stability vs. Change in Temperature: (See Ordering Information)					
Stability Code 02	-20.0	-	20.0	ppb	1
Stability Code 05	-50.0	-	50.0	ppb	1
Stability Code 10	-100.0	-	100.0	ppb	1
Operating Temperature Range: (See Ordering Information)					
Temperature Code 0	0	-	70	°C	
Temperature Code 1	-20	-	75	°C	
Temperature Code 2	-40	-	85	°C	
Temperature Code 3	-40	-	70	°C	
Frequency Calibration:	-1.0	-	1.0	ppm	2
Frequency Stability vs Load	-20	-	20	ppb	±5%
Frequency Stability vs Voltage	-20	-	20	ppb	±5%
Aging: Daily:	-10	-	10	ppb/day	3
Aging: First Year:	-300	-	300	ppb	3
Total Frequency Tolerance (20 Years)	-4.60	-	4.60	ppm	4
Supply Voltage: (Vcc)	3.13	3.30	3.47	Vdc	5
Power Consumption: Vcc = Nominal Voltage					
Commercial Temperature Range, 0 to 70 °C					
Turn On	-	-	2.5	W	
Steady State @ 25°C	-	-	1.1	W	
Industrial Temperature Range, -40 to 85 °C					
Turn On	-	-	3.0	W	
Steady State @ 25°C	-	-	1.3	W	
Phase Jitter: (BW: 12 KHz to Fo/2)	-	0.5	1.0	ps RMS	
Short Term Stability	-	-	1.0E-9/s		
Start-Up Time:	-	-	10	ms	
Warm Up Time (Within Specification @ 25°C)	-	-	60	s	
Warm Up Time (Within Specification @ -40°C)	-	-	90	s	

CMOS Output Characteristics

Parameter	Minimum	Nominal	Maximum	Units	Notes
Load	-	15	-	pF	6
Output Voltage:					
3.3 Vdc Models					
High (Voh)	2.70	-	-	V	
Low (Vol)	-	-	0.30		
Duty Cycle at 50% of Vcc	45	50	55	%	
Rise / Fall Time: 10% to 90%	-	-	6.5	ns	



Phase Noise Characteristics

Typical Phase Noise for DOC050F - 010.0M

Parameter	Minimum	Nominal	Maximum	Units	Notes
@ 1 Hz offset	-	-67	-	dBC/Hz	
@ 10 Hz offset	-	-100	-	dBC/Hz	
@ 100 Hz offset	-	-130	-	dBC/Hz	
@ 1 KHz offset	-	-148	-	dBC/Hz	
@ 10 KHz offset	-	-154	-	dBC/Hz	
@ 100 KHz offset	-	-155	-	dBC/Hz	

OCVCXO Input Characteristics (Optional)

Parameter	Minimum	Nominal	Maximum	Units	Notes
Control Voltage Range:	0.30	1.65	3.00	V	7
Frequency Pullability:	±10.0	-	-	ppm	8
Input Impedance	100K	-	-	Ohms	
Linearity	±5	-	-	%	

Package Characteristics

Package	Package consisting of a FR4 substrate and Ryton-R4 cover. Water Resistant, non-hermetic seal.
---------	---

Environmental Characteristics

Shock	500 G's 1ms, Halfsine, 3 shocks per direction, per MIL-STD 202G, Method 213B Test Condition D.
Sinusoidal Vibration	0.06" D.A. or 10G's Peak, 10 to 500 Hz, per MIL-STD-202G, Method 204D, Test Condition A.
Random Vibration	5.35 G's rms. 20 to 2000 Hz per MIL-STD-202G, Method 214, Test Condition 1A, 15 minutes each axis.
Moisture	10 cycles, 95% RH, Per MIL-STD-202G, Method 112.
Marking Permanency	Per MIL-STD-202G, Method 215J.
Solder Process	RoHS compliant, lead free. See solder profile on page 4.

Recommended Cleaning Process

DOC Series Package	Wash only in a inline high pressure wash station that has an air knife and drying capabilities. (Drying temperature range from 85° to 100°C)
--------------------	---

Notes:

1. Frequency stability vs. change in temperature. $[\pm(F_{max} - F_{min})/2.F_0]$.
2. Initial calibration @ 25°C. For OCVCXO control voltage must be fixed.
3. After 30 days of operation
4. Inclusive of calibration @ 25°C, frequency vs. change in temperature, change in supply voltage (±5%), load change (±5%), shock and vibration and 20 years aging
5. Minimum "Power On Time" after rail rises from 0 to within +/-5% of Vcc = 1 second.
Vcc ramp rate must be <0.3 volts per millisecond.
6. Attention: To achieve optimal frequency stability, and in some cases to meet the specification stated on this data sheet, it is required that the circuit connected to this OCXO output must have the equivalent input capacitance that is specified by the nominal load capacitance. Deviations from the nominal load capacitance will have a graduated effect on the stability of approximately 20 ppb per pF load difference.
7. Positive slope. (Frequency increases as Vc voltage increases. To ensure proper operation of OCVCXO's the control voltage input must be biased the nominal control voltage. Failure to bias the Vc input will cause an unstable output condition.
8. Referenced to Fo.

Bulletin	Cx207
Page	3 of 4
Revision	16
Date	19 Nov 2012

CMOS Output Waveform

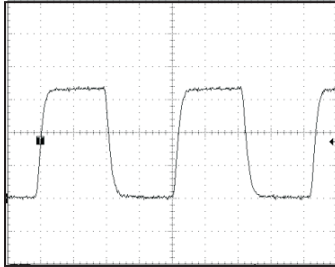

CMOS Test Circuit

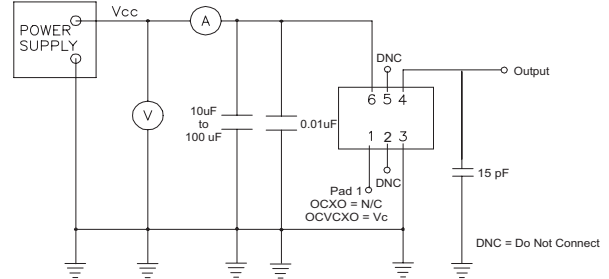

Phase Noise Plot

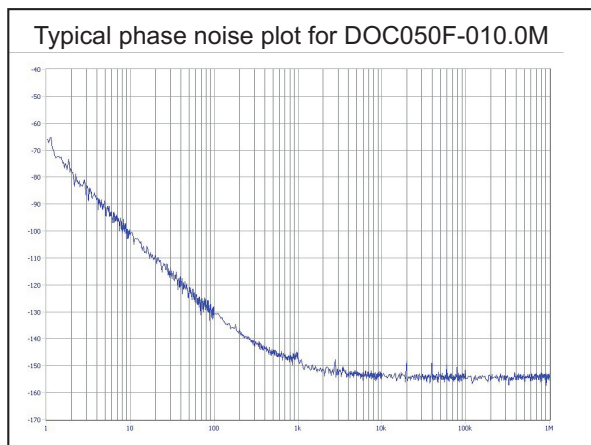

RoHS Solder Profile

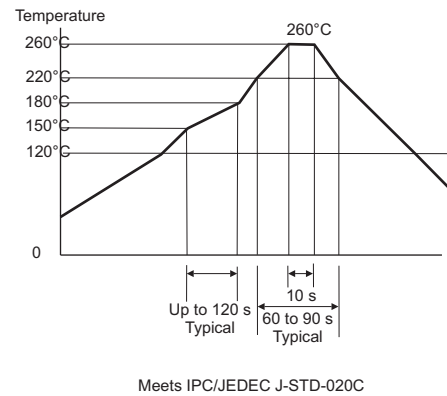

Tape and Reel Information

MEETS EIA-481A & EIAJ-1009B
 500 PCS/REEL MAXIMUM

→ DIRECTION OF FEED (CUSTOMER)

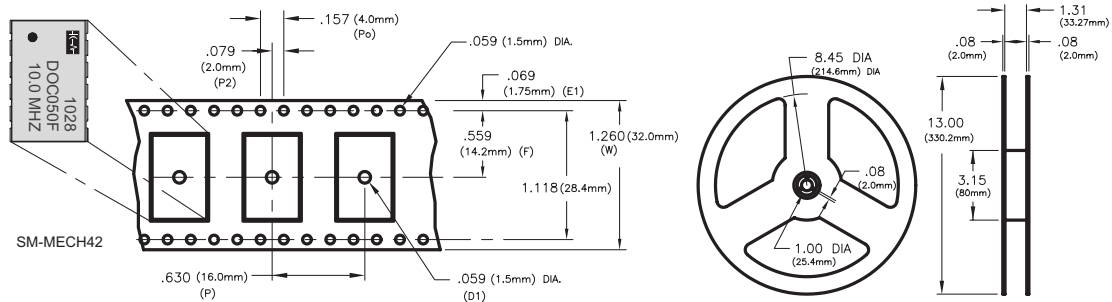

Bulletin	Cx207
Page	4 of 4
Revision	16
Date	19 Nov 2012