

PXAC182908FV

Thermally-Enhanced High Power RF LDMOS FET 240 W, 28 V, 1805 – 1880 MHz

Description

The PXAC182908FV is a 240-watt LDMOS FET with an asymmetrical design intended for use in multi-standard cellular power amplifier applications in the 1805 to 1880 MHz frequency band. Features include dual-path design, input and output matching, high gain and thermally-enhanced package with earless flanges. Manufactured with Wolfspeed's advanced LDMOS process, this device provides excellent thermal performance and superior reliability.

PXAC182908FV
Package H-37275G-6/2

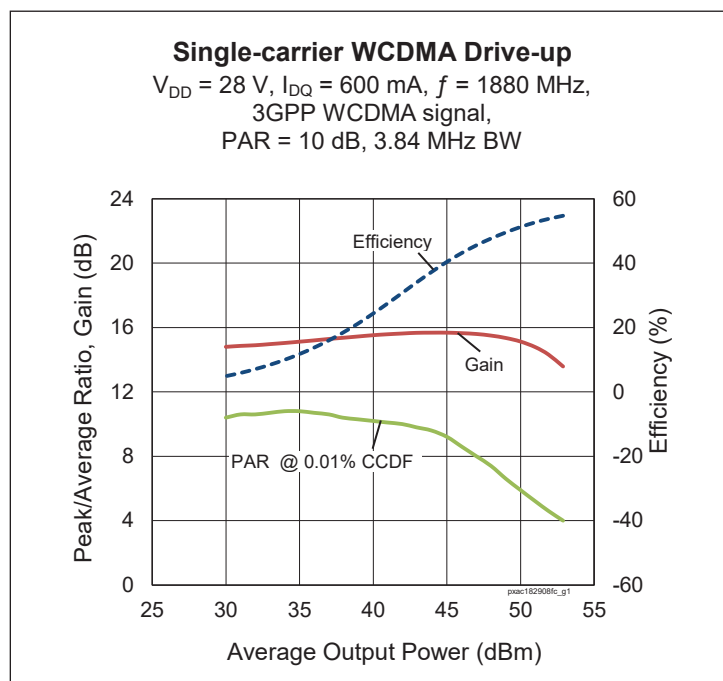
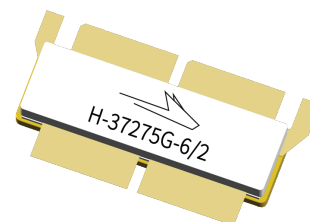

Features

- Broadband internal input and output matching
- Asymmetrical Doherty design
 - Main : $P_{1dB} = 120\text{ W Typ}$
 - Peak : $P_{1dB} = 220\text{ W Typ}$
- Typical Pulsed CW performance, 1842.5 MHz, 28 V, combined outputs
 - Output power at $P_{1dB} = 240\text{ W}$
 - Efficiency = 52.6%
 - Gain = 14.5 dB
- Capable of handling 10:1 VSWR @ 28 V, 240 W (CW) output power
- Human Body Model Class 2 (per ANSI/ESDA/ JEDEC JS-001)
- Integrated ESD protection
- Low thermal resistance
- Pb-free and RoHS compliant

RF Characteristics

Single-carrier WCDMA Specifications (tested in Wolfspeed Doherty test fixture)

$V_{DD} = 28\text{ V}$, $I_{DQ} = 600\text{ mA}$, $V_{GSPEAK} = 0.70\text{ V}$, $P_{OUT} = 70\text{ W avg}$, $f_1 = 1880\text{ MHz}$, 3GPP signal, channel bandwidth = 3.84 MHz, peak/average = 10 dB @ 0.01% CCDF

Characteristic	Symbol	Min	Typ	Max	Unit
Gain	G_{ps}	14	15	—	dB
Drain Efficiency	η_D	49.5	51	—	%
Adjacent Channel Power Ratio	ACPR	—	-27.5	-25	dBc

All published data at $T_{CASE} = 25^\circ\text{C}$ unless otherwise indicated

ESD: Electrostatic discharge sensitive device—observe handling precautions!

DC Characteristics (each side)

Characteristic	Conditions	Symbol	Min	Typ	Max	Unit
Drain-Source Breakdown Voltage	$V_{GS} = 0\text{ V}, I_{DS} = 10\text{ mA}$	$V_{(BR)DSS}$	65	—	—	V
Drain Leakage Current	$V_{DS} = 28\text{ V}, V_{GS} = 0\text{ V}$	I_{DSS}	—	—	1	μA
	$V_{DS} = 60\text{ V}, V_{GS} = 0\text{ V}$	I_{DSS}	—	—	10	μA
On-State Resistance (main)	$V_{GS} = 10\text{ V}, V_{DS} = 0.1\text{ V}$	$R_{DS(on)}$	—	0.11	—	Ω
	(peak) $V_{GS} = 10\text{ V}, V_{DS} = 0.1\text{ V}$	$R_{DS(on)}$	—	0.06	—	Ω
Operating Gate Voltage (main)	$V_{DS} = 28\text{ V}, I_{DQ} = 600\text{ mA}$	V_{GS}	2.45	2.70	2.95	V
	(peak) $V_{DS} = 28\text{ V}, I_{DQ} = 0\text{ A}$	V_{GS}	0.45	0.60	0.80	V
Gate Leakage Current	$V_{GS} = 10\text{ V}, V_{DS} = 0\text{ V}$	I_{GSS}	—	—	1	μA

Maximum Ratings

Parameter	Symbol	Value	Unit
Drain-Source Voltage	V_{DSS}	65	V
Gate-Source Voltage	V_{GS}	-6 to +10	V
Operating Voltage	V_{DD}	0 to +32	V
Junction Temperature	T_J	225	$^{\circ}\text{C}$
Storage Temperature Range	T_{STG}	-65 to +150	$^{\circ}\text{C}$
Thermal Resistance (main, $T_{CASE} = 70^{\circ}\text{C}$, 56 W CW)	$R_{\theta JC}$	0.56	$^{\circ}\text{C}/\text{W}$
	(peak, $T_{CASE} = 70^{\circ}\text{C}$, 200 W CW)	$R_{\theta JC}$	0.29

Ordering Information

Type and Version	Order Code	Package Description	Shipping
PXAC182908FV V1 R0	PXAC182908FV-V1-R0	H-37275G-6/2, earless flange	Tape & Reel, 50 pcs
PXAC182908FV V1 R250	PXAC182908FV-V1-R250	H-37275G-6/2, earless flange	Tape & Reel, 250 pcs

Typical Performance (data taken in a production test fixture)

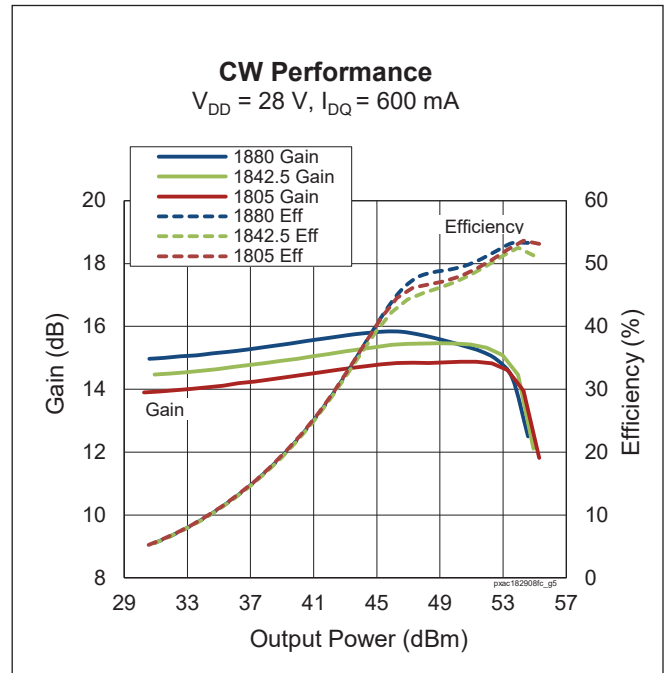
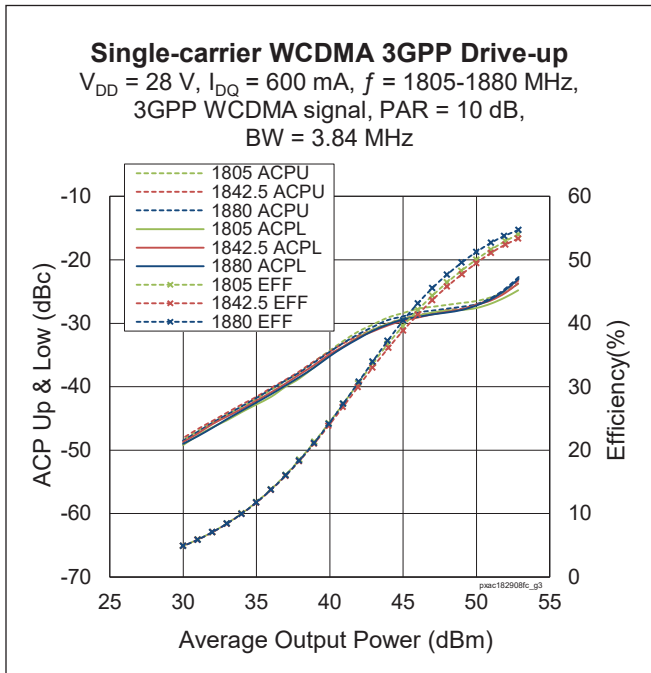
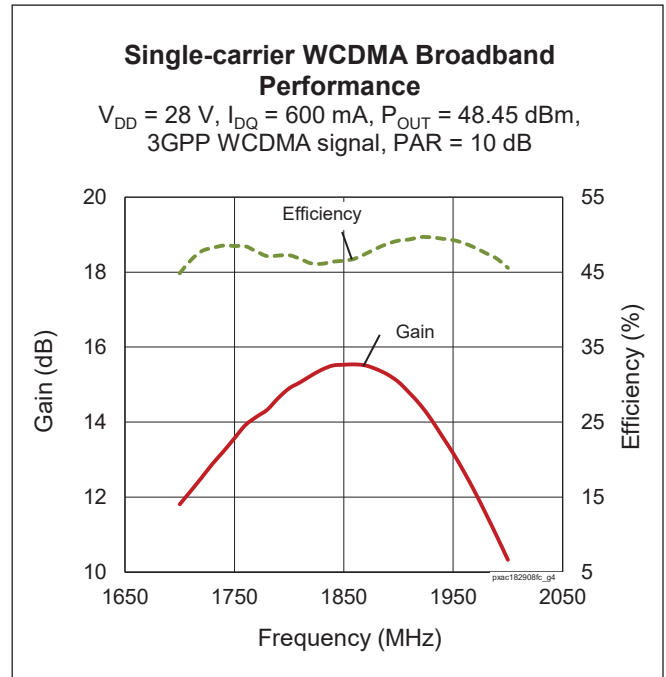
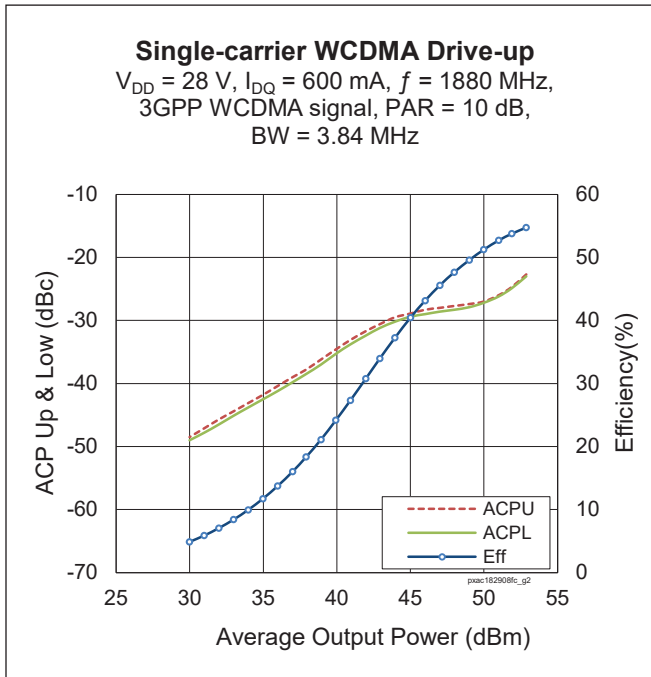

Typical Performance (cont.)

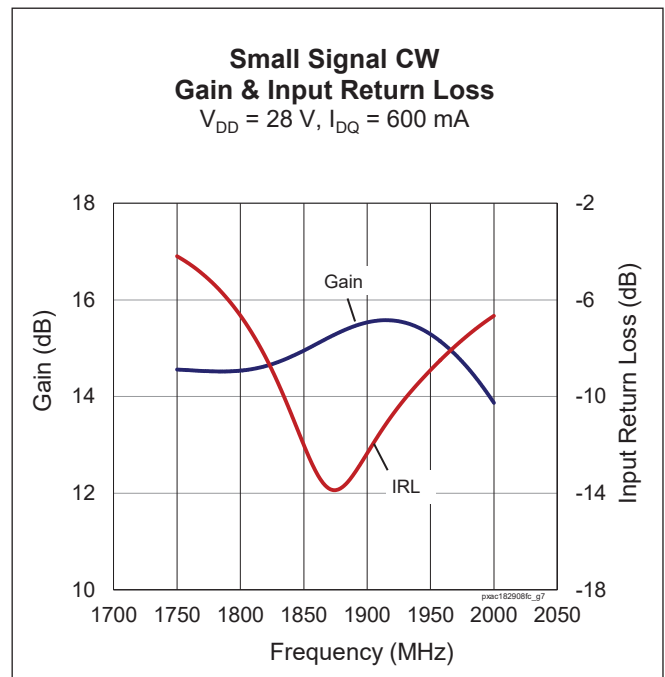
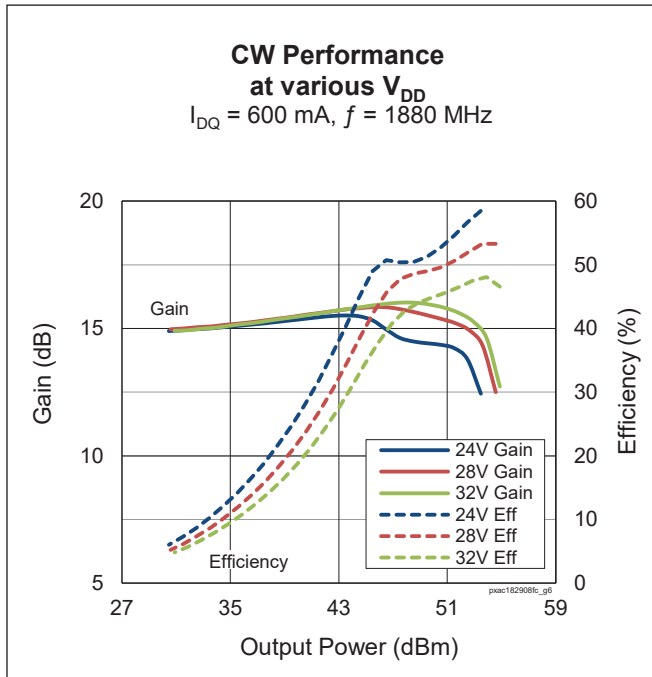

Load Pull Performance

Main Side Load Pull Performance – Pulsed CW signal: 10 μs , 10% duty cycle, 28 V, $I_{DQ} = 720 \text{ mA}$

Freq [MHz]	Z_s [Ω]	P_{1dB}									
		Max Output Power					Max PAE				
		Z_L [Ω]	Gain [dB]	P_{OUT} [dBm]	P_{OUT} [W]	η_D [%]	Z_L [Ω]	Gain [dB]	P_{OUT} [dBm]	P_{OUT} [W]	η_D [%]
1805	4.98+j9.12	2.04-j3.48	19.6	51.3	133	55.3	3.50-j2.06	21.4	50.0	99	63.6
1842.5	2.98+j7.93	2.19-j3.56	19.0	51.3	136	55.9	3.48-j1.96	20.9	49.9	99	64.0
1880	1.98+j6.60	2.18-j3.52	20.0	51.2	132	55.7	3.36-j1.89	21.9	49.8	95	64.0

Peak Side Load Pull Performance – Pulsed CW signal: 10 μs , 10% duty cycle, 28 V, $I_{DQ} = 100 \text{ mA}$

Freq [MHz]	Z_s [Ω]	P_{1dB}									
		Max Output Power					Max PAE				
		Z_L [Ω]	Gain [dB]	P_{OUT} [dBm]	P_{OUT} [W]	η_D [%]	Z_L [Ω]	Gain [dB]	P_{OUT} [dBm]	P_{OUT} [W]	η_D [%]
1805	0.68-j3.85	4.06-j3.83	18.6	54.2	261	55.4	3.01-j0.87	20.4	52.5	176	64.1
1842.5	0.60-j4.14	4.50-j3.68	18.9	54.1	258	55.3	3.02-j1.36	20.6	52.8	192	64.3
1880	0.87-j4.71	5.12-j3.69	18.8	54.0	249	54.0	3.01-j1.52	20.5	52.8	192	64.6

Reference Circuit , 1805 – 1880 MHz

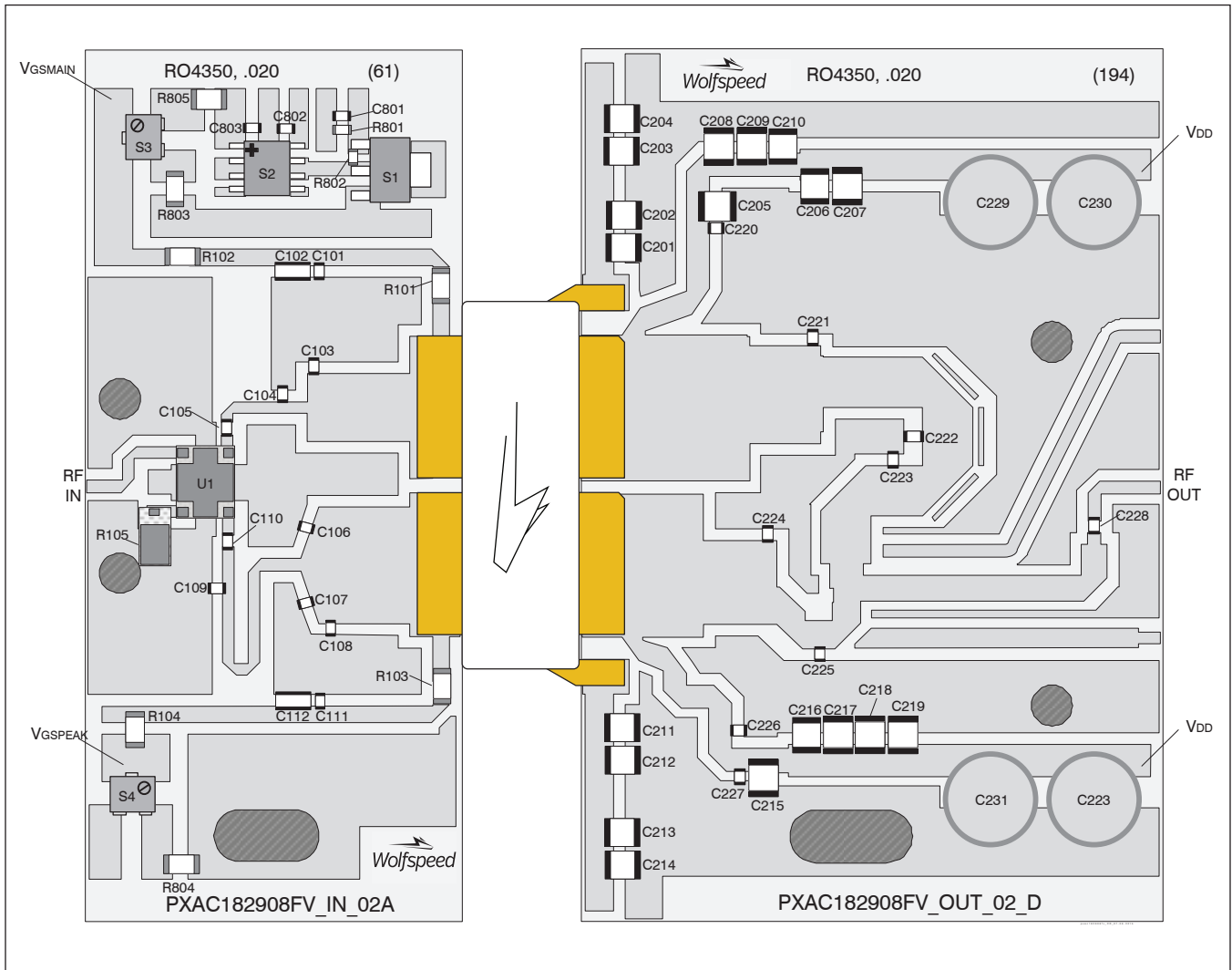

Reference circuit assembly diagram (not to scale)

Reference Circuit (cont.)**Reference Circuit Assembly**

DUT	PXAC182908FV V1
Test Fixture Part No.	LTA/PXAC182908FV V1
PCB	Rogers 4350, 0.508 mm [0.020"] thick, 2 oz. copper, $\epsilon_r = 3.66$, $f = 1805 - 1880$ MHz
Find Gerber files for this test fixture on the Wolfspeed Web site at http://www.wolfspeed.com/RF	

Components Information

Component	Description	Manufacturer	P/N
Input			
C101, C105, C110, C111	Capacitor, 18 pF	ATC	ATC100A180JW150XB
C102, C112	Capacitor, 10 μ F	Murata	LLL31BC70G106MA01L
C103	Capacitor, 1.5 pF	ATC	ATC100A1R5CW150XB
C104	Capacitor, 3.0 pF	ATC	ATC100A3R0CW150XB
C106	Capacitor, 0.4 pF	ATC	ATC100A0R4CW150XB
C107	Capacitor, 1.0 pF	ATC	ATC100A1R0CW150XB
C108	Capacitor, 0.7 pF	ATC	ATC100A0R7CW150XB
C109	Capacitor, 0.5 pF	ATC	ATC100A0R5CW150XB
C801, C802, C803	Capacitor, 1000 pF	Panasonic Electronic Components	ECJ-1VB1H102K
R101, R103	Resistor, 5.1 Ω	Panasonic Electronic Components	ERJ-8GEYJ5R1V
R102, R104	Resistor, 1K Ω	Panasonic Electronic Components	ERJ-8GEYJ102V
R105	Resistor, 50 Ω	Richardson	RICHARDSON
R801	Resistor, 1.3K Ω	Panasonic Electronic Components	ERJ-3GEYJ132V
R802	Resistor 1.2K Ω	Panasonic Electronic Components	ERJ-3GEYJ122V
R803, R804, R805	Resistor, 50 Ω	Panasonic Electronic Components	ERJ-8GEYJ510V
S1	Transistor	Infineon Technologies	BCP56
S2	Voltage regulator	Texas Instruments	LM78L05ACM
S3, S4	Potentiometer, 2k Ω	Bourns Inc.	3224W-1-202E
U1	Hybrid coupler	Anaren	X3C19P1-05S
Output			
C201, C202, C203, C204, C205, C206, C207, C208, C209, C210, C211, C212, C213, C214, C215, C216, C217, C218, C219	Capacitor, 10 μ F	Taiyo Yuden	UMK325C7106MM-T
C220, C226, C227, C228	Capacitor, 18 pF	ATC	ATC100A180JW150XB
C221	Capacitor, 2.2 pF	ATC	ATC100A2R2CW150XB
C222	Capacitor, 0.3 pF	ATC	ATC100A0R3CW150XB
C223	Capacitor, 1.2 pF	ATC	ATC100A1R2CW150XB
C224	Capacitor, 0.4 pF	ATC	ATC100A0R4CW150XB
C225	Capacitor, 1.1 pF	ATC	ATC100A1R1CW150XB
C229, C230, C231, C232	Capacitor, 220 μ F	Panasonic Electronic Components	EEE-FP1V221AP



Pinout Diagram (top view)

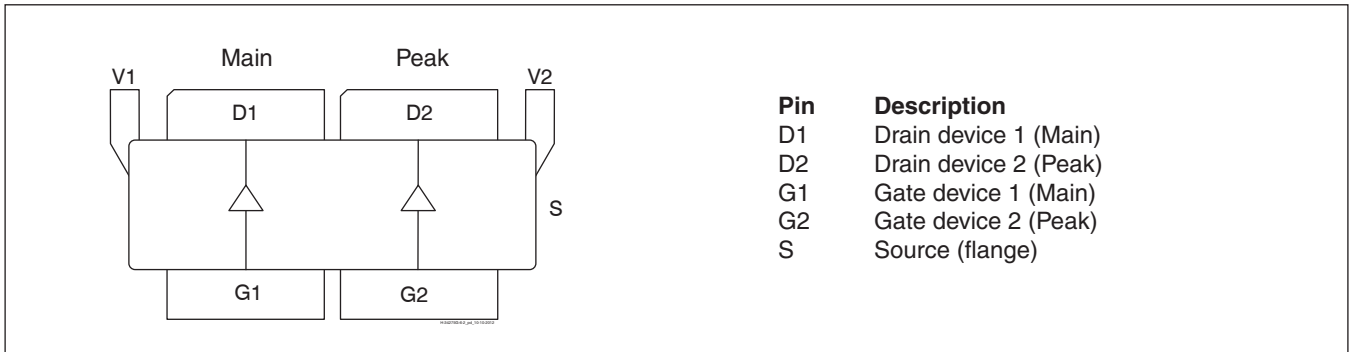

Lead connections for PXAC182908FV

Package Outline Specifications

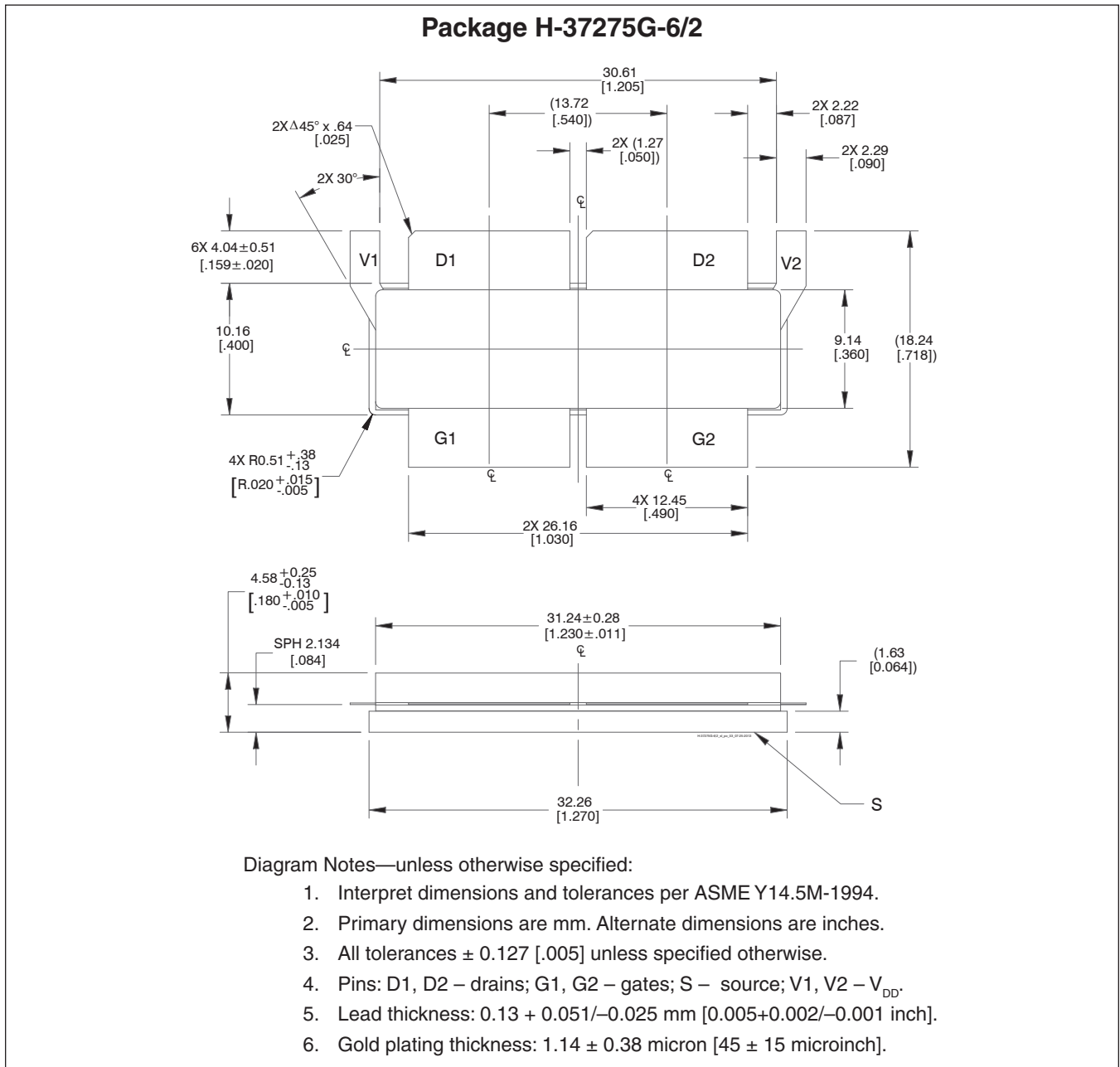

Revision History

Revision	Date	Data Sheet Type	Page	Subjects (major changes since last revision)
01	2015-01-08	Advance	All	Data Sheet reflects advance specification for product development
01.1	2015-01-29	Advance	2	Updated thermal resistance
02	2015-07-07	Production	All All	Data Sheet reflects released product specification Revised all data and includes updated final specs, typical performance graphs, loadpull, reference circuit, package outline
02.1	2015-07-29	Production	4	Corrected Drain Eff to PAE in Load Pull tablehead
03	2018-06-25	Production	All	Converted to Wolfspeed Data Sheet

For more information, please contact:

4600 Silicon Drive
Durham, North Carolina, USA 27703
www.wolfspeed.com/RF

Sales Contact
RFSales@wolfspeed.com

RF Product Marketing Contact
RFMarketing@wolfspeed.com
919.407.7816

Notes

Disclaimer

Specifications are subject to change without notice. Cree, Inc. believes the information contained within this data sheet to be accurate and reliable. However, no responsibility is assumed by Cree for any infringement of patents or other rights of third parties which may result from its use. No license is granted by implication or otherwise under any patent or patent rights of Cree. Cree makes no warranty, representation or guarantee regarding the suitability of its products for any particular purpose. "Typical" parameters are the average values expected by Cree in large quantities and are provided for information purposes only. These values can and do vary in different applications and actual performance can vary over time. All operating parameters should be validated by customer's technical experts for each application. Cree products are not designed, intended or authorized for use as components in applications intended for surgical implant into the body or to support or sustain life, in applications in which the failure of the Cree product could result in personal injury or death or in applications for planning, construction, maintenance or direct operation of a nuclear facility.