



RoHS Compliant

SPECIFICATION FOR APPROVAL

TO : _____

PAGE : 2/4

CUSTOMER PART NO	REV. 00	DELTA PART NO. DSP-06090	ISSUE DATE Feb.13,2017	TEMP(°C) 25
PART NAME Solenoid Pump		DELTA REV. 01	USED ON	HUM (%) 58 RH

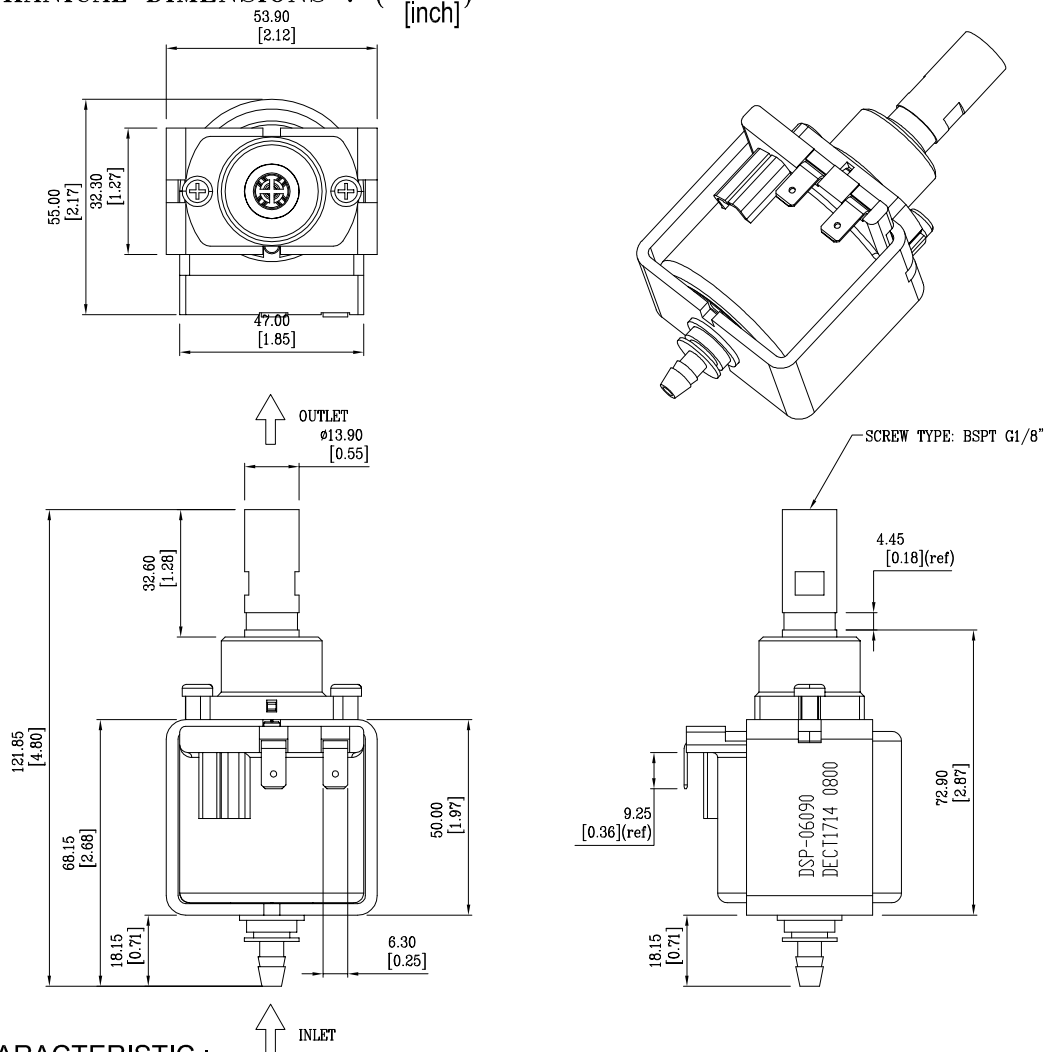
1. MECHANICAL DIMENSIONS : ($\frac{\text{mm}}{\text{[inch]}}$)

2. CHARACTERISTIC :

- 2-1. OPERATING VOLTAGE: 110Vac / 60Hz
- 2-2. POWER CONSUMPTION: 48W
- 2-3. OUTLET : BSPT G1/8"
- 2-4. FLOW RATE MAX : 900 c.c./min
- 2-5. FLOW RATE TOLERANCE : ±15%
- 2-6. PRESSURE MAX : 87 psi (6 bar)
- 2-7. WATER TEMPERATURE : 20 °C
- 2-8. WORKING CYCLE : 30 sec ON / 15 sec OFF
- 2-9. INTEGRATED DIODE
- 2-10. TEMPERATURE CLASS : F (155°C)
- 2-11. MAX. ON TIME : 11 min



RoHS Compliant

SPECIFICATION FOR APPROVAL

TO : _

PAGE : 3/4

CUSTOMER PART NO	REV. 00	DELTA PART NO. DSP-06090	ISSUE DATE Feb.13,2017	TEMP(°C) 25
PART NAME Solenoid Pump		DELTA REV. 01	USED ON	HUM (%) 58 RH

2. PRODUCT S/N :

DSP-06090
DECT1714 0800

NOTES:

"DSP-06090" IS DELTA P/N
 "DECT" IS DELTA Chachoengsao plant
 "1714": 17 IS YEAR ; 14 IS WEEK
 "0800" : 08 IS SHIP DATE ; 00 IS PRODUCTION LINE OF NO.

3. P-Q CURVE :

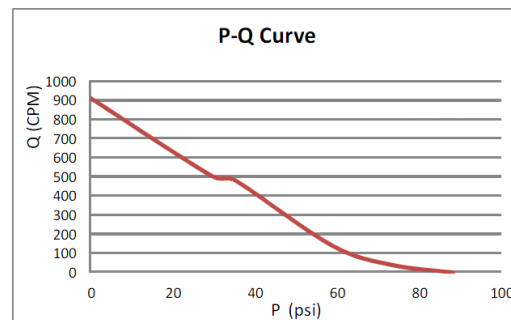
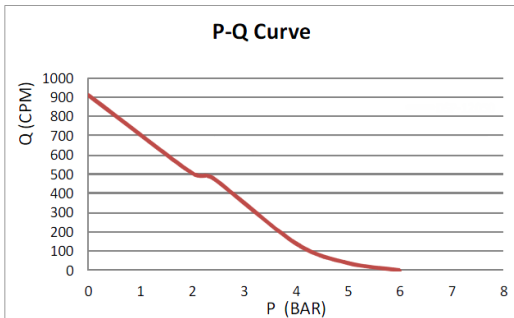

4. NOISE TEST : 51.1 dBA (at p=0 Bar/ 100cm)

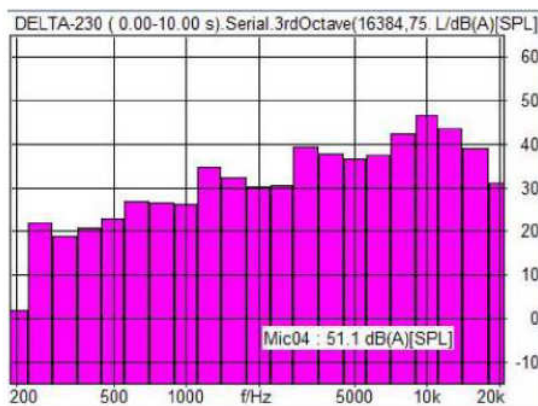



RoHS Compliant

SPECIFICATION FOR APPROVAL

TO : _

PAGE : 4/4

CUSTOMER PART NO	REV. 00	DELTA PART NO. DSP-06090	ISSUE DATE Feb.13,2017	TEMP(°C) 25
PART NAME Solenoid Pump		DELTA REV. 01	USED ON	HUM (%) 58 RH

5. EMC TEST :

3-1. BACKGROUND

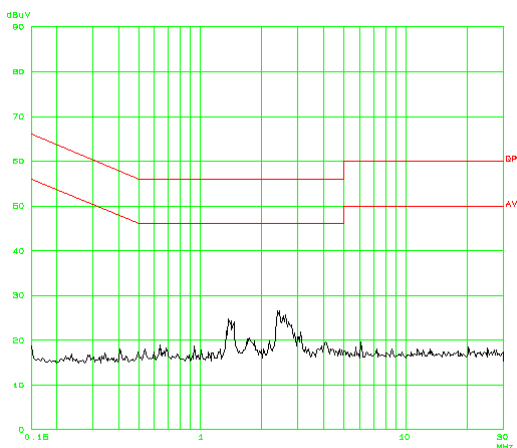

3-2. STANDBY

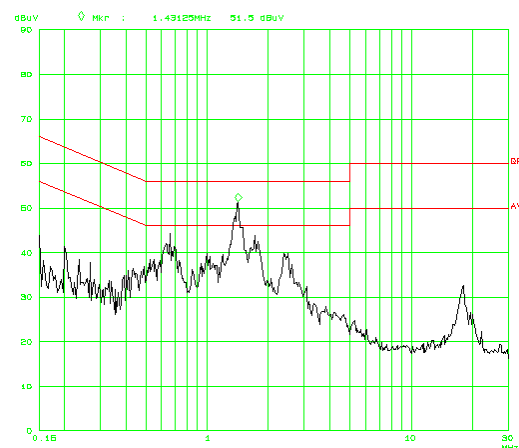

1.43125 MHz QP 49.7dB AV 43dB

3-3. OPERATION

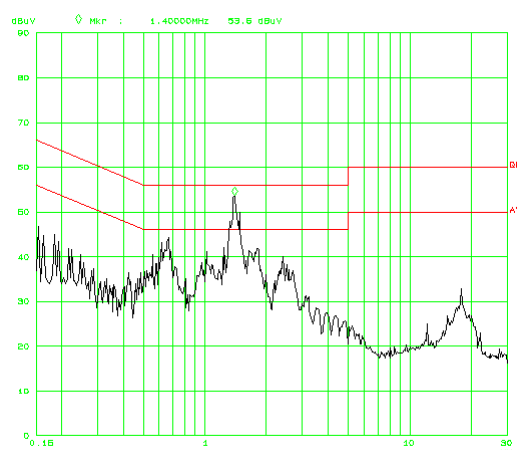

1.4 MHz QP 49dB AV 42.5dB