



nt
magnetics

nuvotem

- Encapsulated PC Transformers 1VA - 160VA
- Power Transformers 1VA - 7.5kVA
- Encapsulated Styles 1VA - 500VA
- Special Mounting Configurations

In Standard Configurations and to Customer Specifications

SECTION 1



Toroidal Transformers for Universal Application



TALEMA PROFILE

The TALEMA International Group of companies began in 1975 with the formation of Talema Elektronik GmbH in Munich, Germany. Five years later, in 1980 Nuvotem Teo started manufacturing in Ireland. In 1988 Talema began production in India and expanded into the Czech Republic with the formation of TALEMA spol s.r.o. in 1992.

Today the TALEMA International Group, with three manufacturing facilities and over 1000 employees in Europe and the Far East, is a world leader in the manufacture of toroidal transformers and related magnetic components. The vast majority of the output, around 85%, is of custom built products although a comprehensive range of standard devices is also available.



Note: All products manufactured by the Talema Group are RoHS compliant.



Application

TALEMA Toroidal Transformers meet modern day requirements for a small size, low magnetic interference field transformer. Featuring a nearly ideal physical construction, the design engineer can expect excellent performance. Small size and weight (approximately 50% of conventional transformers), extremely low noise and low magnetic interference field make the toroidal transformer ideal for compact power supplies. Modern production techniques make it possible to produce toroidal transformers at practically the same prices as conventional transformers making them ideal for a wide range of applications including:

- professional audio equipment
- computers and peripherals
- video monitors
- motor controls
- compact power supplies
- medical equipment
- instrumentation
- office machines
- industrial control equipment
- low voltage lighting

Volume and weight

The toroidal core has the optimal shape for producing a transformer with the minimum of material. Because the quality of the core is such a vital consideration for sensitive applications, TALEMA has invested heavily to provide extensive core manufacturing, annealing and testing facilities.

All windings are symmetrically spread over the entire core which makes the wire length very short. A higher flux density is possible as the magnetic flux is in the same direction as the rolling direction of the grain orientated core allowing significant savings of volume and weight. A higher current density can flow through the wire as the whole surface of the toroidal core allows efficient cooling of the copper windings.

The iron losses of the toroidal core are very small, typically 1.1W/kg at 1.7 Tesla and 50Hz, giving very small magnetizing current, which contributes to the excellent temperature rating of the toroidal transformer.

Transformer hum

Because there are no air gaps, there are no loose sheets which can vibrate. In addition, the high quality of the grain orientated silicone alloyed electric steel makes the magnetostriction very low, thus allowing the disturbing hum found in most common types of transformers to be almost completely eliminated.

Mounting details

For sizes up to 1000VA, a low cost assembly can be made with a centering washer and a center screw or bolt. Transformers in the range of 15VA through 500VA can also be potted in standard Polyamid housings. All transformers can also be center potted - either with a center hole or with a threaded insert.



Production program

Standard Distribution: Open wound, Standard and Mini; Encapsulated; Print & DIN Rail Transformers - 230V primary, with ENEC KEMA-KEUR marking (see page 8);

Customer standards: Open wound, Encapsulated, Print, DIN Rail, a wide range of secondary voltages and mounting styles (see page 6);

Specials: per customer specification (see page 5)

- Power: 1.6VA - 7.5kVA per phase
- Special sizes; extremely flat or small diameter, i.e., up to 250VA with 96mm O.D. for European P.C. formats
- Electrostatic copper shielding
- Operating frequencies up to 20kHz
- Assembled 3 phase sets
- Magnetic shielding
- Potting in special housings for sizes up to 1.2kVA
- Secondary voltages available up to 1kV

Safety

All TALEMA Stock Transformers from 15VA to 1kVA are delivered with ENEC KEMA marking according to EN61558 (VDE 0570, EN61558) protection class II, tested with 4500V_{AC} between primary and secondary windings. Special types can be made as safety transformers according to EN61558. This European Standard replaces the generally known VDE Standard 0570. Additionally, upon request we supply toroidals according to conventional standards, including UL, CSA and others, for office equipment, data processing, entertainment electronics and medical instrumentation.

Efficiency

The toroidal shape gives a significantly higher efficiency compared to conventional transformers of the same size. The advantage is either an increased output power with the same size or a lower weight and smaller size at the same output power.



Delivery

Various production facilities allow fast delivery and ensure continuity of supply to our customers.

Internationally Recognized Quality Systems and Approvals

Factory / Process Approvals

ISO-9001 approved quality systems ensure all internal processes run smoothly and efficiently, from incoming purchase orders through Resource Planning, Scheduling and Production, to the delivery of the finished products.

- NT Magnetics s.r.o., ISO-9001:2000, Cert. No. 1210024333
- Talema Electronic (India) Pvt. Ltd.; ISO-9001:2000, Cert. 9910001047 TS 16949:2002, 1211127793/01TMS ISO-14001:2004, 1210427793TMS

Product Approvals

TALEMA-NUVOTEM has numerous approvals covering a wide variety of international standards, including both standard and custom designed parts. By working closely with equipment designers and international test houses, the TALEMA Groups' engineering teams can assist in ensuring swift and smooth approval of equipment using its transformers and inductors.

Family Recognitions

The TALEMA Group have invested considerable time and effort to obtain "Family Approvals" enabling automatic recognition of custom transformers without having to send each new design to a certified test facility for approval, saving the customer both time and money.

UL Approvals

- **UL506**, General Application Transformers - Family approval to 3000VA for classes A & B UL File No. E215495
- **UL544**, Transformers for Medical and Dental Equipment - Family approval to 3000VA for classes A & B UL File No. E218027
- Insulation Systems with Temperature Classes B, B1 & F, applicable to transformers for both UL506, UL544 and UL60601-UL File No. 217412
- **UL1950**, Information Technology Equipment, including Electrical Business Equipment - 70000K series PCB transformers UL File No. E218027, Vol. 2
- **UL6500**, Audio/Video and Musical apparatus - 70000K series PCB transformers - UL File No. E218027, Vol. 2



- **UL60601-1**, Medical Equipment - Family approval to 3000VA for classes A & B - (UL File No. E251176)

EN Approvals

TALEMA-NUVOTEM has the distinction of being one of the very few toroidal transformer manufacturers to have a "General Approval" of custom designed power transformers to EN61558.

- **EN61588/VDE0570** - Isolation Transformers (Pri. 440V/Sec. 250V) Family approval and custom designs to 3000VA ("Non Short-circuit proof") Kema No. 2060938.02
- Safety Isolation Transformers (Pri.440V / Sec. 50V) Family approval and custom designs to 3000VA ("Non Short-circuit proof") Kema No. 2060938.03
- Safety Isolation Transformers (Pri.110-240V / Sec. 50V) Family approval and custom designs to 300VA ("Non Inherently Short-circuit proof") Kema No. 2060938.01
- **EN60950/VDE0805/IEC950/UL506/UL1950** - Family approval for 70000K PCB Transformers (VDE File No. 5803/ UL File No. E218027)

Talema toroidal transformers can also be designed to meet the following International Regulations

- VDE0750 (EN60601, IEC601) Medical and Dental Equipment
- VDE0805 (EN60950, IEC950) IT installations including office equipment
- VDE0860 (EN60065, IEC65) Electrical equipment for domestic use



In-rush Current

Due to lack of air gaps, toroidal transformers generally have a higher inrush current than normal transformers. For mains fuses we recommend the use of slow blowing types, especially for output power rates in excess of 500VA.

Frequency Range

TALEMA Standard Transformers are designed for operating frequencies between 48 Hz and 60Hz and operate up to 450 Hz maximum. With increasing frequency, the transformer size decreases accordingly. Core materials for frequencies up to 100kHz are available in materials such as thin tape wound nickel alloy, molded powder or sintered ferrite.

Autotransformers

An autotransformer allows smaller dimensions and a more economical over all design in cases where galvanically separated windings are not required (graph 1)

Graph 1 (Autotransformers)

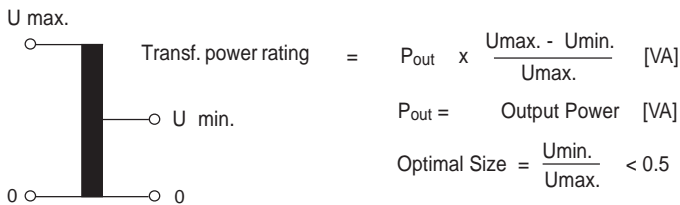

Voltage Drop

The secondary voltages and currents are valid as shown on page 10 for normal output power. At partial load the output voltage, as a function of transformer size, will be accordingly higher. Graph 2 shows the % voltage increase for TALEMA Standard Toroidal Transformers at no load conditions.

Graph 2 (Voltage Drop)

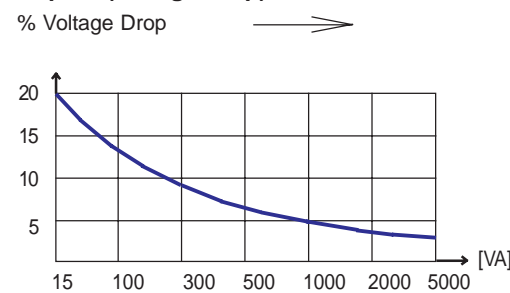

Duty Cycle

A smaller transformer can be used if the load is intermittent. Because the output power in this case significantly exceeds the nominal power, the secondary voltage drops below the voltages shown on page 8. The voltage drop increases proportionately with the current being drawn (graph 3).

Graph 3 (Duty Cycle)

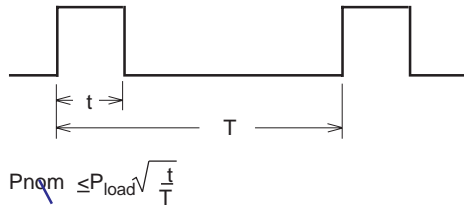

Temperature rise

As can be seen from graphs 5 and 6, TALEMA Standard Toroidal Transformers are designed for a temperature rise of 60°C to 70°C at nominal load. When choosing a transformer size, the ambient temperature and heat sink coefficient of the mounting place must be taken into consideration. Graphs 5 & 6 show the typical temperature change which occurs as a function of output power or overload.

Efficiency

Graph 4 shows typical efficiency which can be expected as a function of the power relationship P_{out} / P_{nom} and transformer size.

Graph 4 (Efficiency)

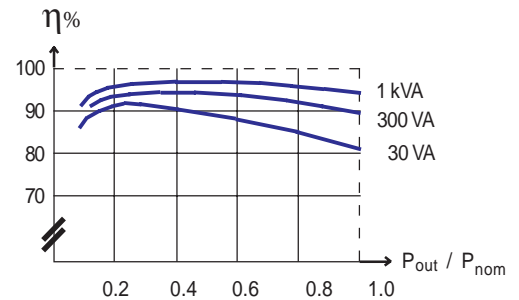

Graph 5

(Ambient Temperature)

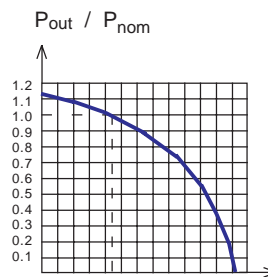

Graph 6

(Temperature Rise)

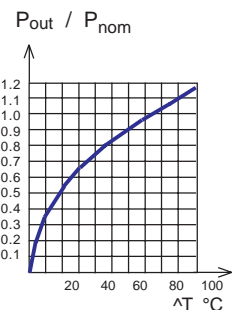

Rectifying

Graphs 7 and 8 give formulas for calculation of approximate values of the transformers and are primarily dependent on the size of the loading capacitor to be used. The applied form factor "F" is rated between 1.1 for smaller capacitors and up to 2.5 for for relatively large capacitors.

Graph 7

(Rectifying)

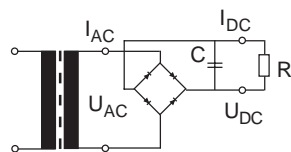

$$U_{AC} \approx \frac{U_{DC}}{\sqrt{2}} + 2 [V_{eff}]$$

$$I [A]$$

$$t \cdot I [Sec^{-1}]$$

$$C [F]$$

$$I_{AC} \approx F \cdot I_{DC} [A]$$

$$ripple \ \Delta U \approx \frac{I \cdot t}{C}$$

$$t_{Bridge} = 1 / 100 \text{ at } 50 \text{ Hz}$$

$$t_{Bridge} = 1 / 120 \text{ at } 60 \text{ cycles}$$

Graph 8

(Rectifying)

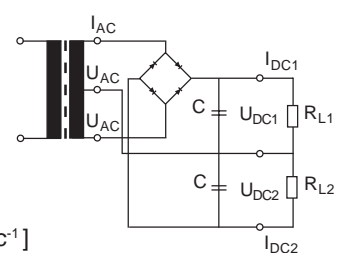

$$U_{AC} \approx \frac{U_{DC}}{\sqrt{2}} + 1 [V_{eff}]$$

$$I_{AC} \approx \frac{F \sqrt{I_{DC1}^2 + I_{DC2}^2}}{\sqrt{2}} [A]$$

Special Transformers

If we do not have a customer or stock standard which meets your requirements, we can offer expert engineering assistance to develop the special transformer you need. We stock the materials for the sizes shown on table 2 (page 6) and can supply other sizes as well on short notice.

Capabilities

- Power: 1VA - 7500VA / phase
- Assembled 3 phase sets
- Special sizes - extremely flat or small diameter
- Static copper shielding
- Magnetic shielding
- Operating frequencies to 20kHz
- Potting in special housings tp 1200VA
- Secondary voltages to 1000 V
- Up to 8 primaries or taps
- Up to 30 secondaries or taps
- Reinforced dielectric to 5000V_{eff}

Table1

Power VA	Core Loss W	Copper Loss (typical)		Dimensions mm		Weight kg
		T = 20°C W	T = 120°C W	O.D. Ø	Height	
5	0.16	0.6	0.8	51	27	0.1
10	0.14	1.1	1.6	58	29	0.3
15	0.21	1.8	2.5	60	31	0.3
20	0.26	2.4	3.3	60	36	0.4
30	0.26	3.6	5.0	70	32	0.5
50	0.39	4.7	6.6	70	44	0.7
50	0.43	4.7	6.6	80	35	0.7
80	0.65	8.4	11.8	80	45	1.0
80	0.51	8.4	11.8	92	36	1.0
120	0.76	9.9	13.9	92	45	1.3
160	1.00	14.9	20.8	92	58	1.5
160	0.97	14.9	20.8	104	44	1.6
225	1.30	15.2	21.3	112	48	2.1
250	1.30	15.7	22.0	95	69	2.3
250	1.20	15.7	22.0	135	38	2.3
300	1.70	16.1	22.5	115	58	2.5
375	2.10	20.0	28.0	115	68	3.0
375	1.90	20.0	28.0	135	48	3.0
500	2.50	22.1	31.0	135	60	3.9
625	3.10	27.9	39.0	140	70	4.6
625	2.90	27.9	42.0	160	48	4.6
800	3.80	30.0	42.0	160	60	5.5
1000	4.80	30.7	43.0	160	72	6.9
1000	4.40	30.7	43.0	200	48	6.9
1300	5.70	42.9	60.0	160	82	8.8
1300	5.90	44.3	62.0	200	65	8.8
1600	7.30	45.0	63.0	200	75	10.5
1900	8.80	47.1	66.0	200	85	12.0
2200	10.30	55.3	76.0	205	90	13.5
2500	11.70	59.3	83.0	205	105	16.6
2500	13.30	59.3	83.0	245	80	15.2
2800	13.30	68.0	95.0	245	80	16.0
3200	15.60	70.0	97.0	245	90	18.6
3700	17.80	73.0	102.0	245	100	21.2
4400	16.80	84.0	116.0	275	95	24.5
5000	22.40	87.0	120.0	275	105	28.0
6000	25.20	97.0	135.0	290	120	31.0
7500	28.60	110.0	153.0	320	100	39.0



Table 2

TALEMA Toroidal Transformers can be quickly supplied to your specific requirements over the following range:

- Primary: 1 x 230V or 2 x 115V
- Secondary: one or two identical windings from 5 V to 60 V

Customer Standards

Ordering Key

- 1) Transformer Power VA
- 2) No. of Primaries
- 3) No. of Secondaries - 2 max.
- 4) Secondary Voltage
- 5) Mounting - Encapsulation
 - O = w/o Centering Disk
 - M = with Centering Disk
 - K = in Polyamid Housing
 - B = with Center Potted Insert
 - H = with Center Potted thru hole
 - D = with DIN 35 rail mtg. bracket
 - L = with vertical mtg. bracket

0030 P1 - 2 - 010 - M
1 2 3 4 5

When ordering 2 secondaries, both must be the same voltage.

Specifications subject to change without notice!

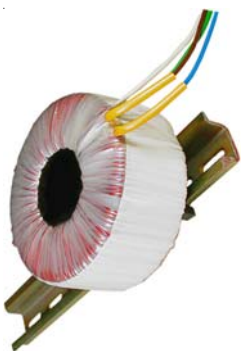

 Center Potting	Mounting Style						
	Nominal Power VA	Dimensions & weight w/o mounting hardware* mm			Style B	Style H	Style D
		A	B	kg	Thread	Center Hole Ø	DIN 35 (B + mm) mm
	15	60	31	0.3	M4	M4	8
	30	70	32	0.5	M4	M4	8
	50	80	35	0.7	M5	M5	10
	80	92	36	0.9	M6	M5	10
	120	92	45	1.2	M6	M5	10
	160	104	44	1.5	M6	M5	10
	225	112	48	1.9	M8	M8	8
	300	115	58	2.3	M8	M8	8
	500	135	60	3.5	M8	M8	--
	625	140	70	4.3	M8	M8	--
	800	160	60	5.1	M8	M8	--
	1000	160	72	6.5	M8	M8	--



Centering Discs

*Allow an extra 3mm to height for mounting kit and 3-4mm to O.D. where leads emerge

 Vertical Mounting Bracket	VA	L	W	H	W1 typ.	X	Y
		50	80	38	75	58	64
	80	95	39	86	59	80	27
	120	95	49	86	69	80	31
	160	105	48	95	68	95	30
	225	112	52	100	72	95	32
	300	117	63	105	83	96	43
	500	135	63	120	83	113	41
	625	140	74	125	94	118	50
	800	160	63	145	83	130	41
	1000	160	75	145	95	130	50

Vertical Mounting Bracket

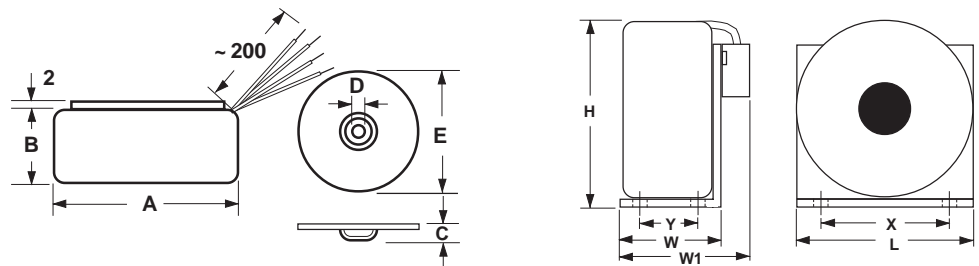

Mounting Disk	Power	Mounting Bolt D	C	E	Mounting Pressure kg
	15	M4	5	50	8
	30 - 50	M5	7	60	12
	80 - 120	M6	7	70	18
	160 - 300	M6	7	90	25
	500 - 625	M8	7	110	30
800 - 1000	M8	8	135	35	

Standard Stock Items

TALEMA Toroidal Transformers with centering washers or potted in Polyamid Housings are available from distribution. Standard primary voltages of 1 x 230V or 2 x 115V on open wound styles and 1 x 230V on encapsulated versions.



Nominal Power VA	Primary			Core Loss W	Copper Loss Typical		Dimensions and weight without Mounting Disks			Potted in Polyamid Housing		
	Full Load Current A	No Load Current mA	Copper Resistance T = 20°C Ohm		T = 20°C W	T = 120°C W	Ø mm	Height* mm	Weight kg	Ø mm	Height mm	Center Hole for Mounting Bolt Ø
15	0.08	2.0	178.0	0.21	1.8	2.5	60	31	0.3	63	34.5	5.1
30	0.15	2.8	92.0	0.26	3.6	5.0	70	32	0.5	73	39	5.1
50	0.25	5.0	42.0	0.43	4.7	6.6	80	35	0.7	87	42	5.1
80	0.40	5.6	27.0	0.51	8.4	11.0	92	36	1.0	97	44	6.1
120	0.53	8.5	15.5	0.76	9.9	13.9	92	45	1.3	104	52	6.1
160	0.79	10.0	10.5	0.97	11.9	20.8	104	44	1.6	115	53	6.1
225	1.08	14.0	6.6	1.30	15.2	21.3	112	48	2.1	126	52	6.1
300	1.41	17.0	4.2	1.70	16.1	22.5	115	58	2.5	126	65	6.1
500	2.32	23.0	1.83	2.50	22.1	31.0	135	60	3.9	147	65	8.2
625	2.90	28.0	1.50	3.10	27.9	39.0	140	70	4.6	--	--	--
1000	4.56	38.0	0.88	4.80	30.7	43.0	160	72	6.9	--	--	--

* Allow an extra 3mm for mounting kit and 3-4mm to the dimensions where the leads emerge

Schematic

Material

Copper (Pri. & Sek.)

Isolation between Primary & Secondary

Lead isolation

Temperature Class

H (180°C)

B (130°C)

A (105°C)

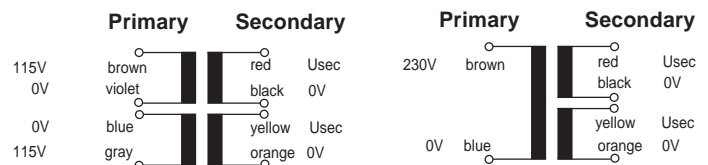

Approvals

Primary: 1 x 230V

approved to EN61558 (VDE0570/IEC61558):

KEMA Nr. 2060938.02 for isolation transformers

KEMA Nr. 2060938.03 for safety isolation transformers

marked with the ENEC KEMA-KEUR stamp of approval

Primary 2 x 115V - as above with added UL stamp

Approval to - UL506 (General Purpose Transformer)

File XPTQ2.E215495 - USA

File XPTQ8.E215495 - Canada

Primary: 2 x 115V / 48 - 60Hz
for series or parallel connection

Secondary: 2 x Usec
for series or parallel connection

Primary: 230V / 48 - 60Hz

Secondary: 2 or 4 x Usec
for series or parallel connection

Leads

Primary: Double insulated leads, 150mm long, 10mm stripped

Secondary: PVC insulated, 150mm long, 10mm tinned



Standard Open and Encapsulated Toroidal Transformers

- small size and low weight
- extremely low level of radiated magnetic field
- high efficiency
- reduced standby current
- very low induced noise (hum)
- 100% electrical and flash tested
- Test Voltage Primary - Secondary 4.5 kV
- Ambient operating temp.: +40°C max.
- Approved to EN61558 (VDE0570 / IEC61558)
- UL Recognized to UL506 under family approval file E215495 for 2 x 115V



Power VA	Part Number		Secondary		
	Primär - Primary		Full Load V	Current A	Open Circuit V
	230V	2 x 115V			
15	0015P1-2-009	0015P2-2-009	2 x 9	0.83	2 x 10.5
	0015P1-2-012	0015P2-2-012	2 x 12	0.63	2 x 14.0
	0015P1-2-015	0015P2-2-015	2 x 15	0.50	2 x 17.4
	0015P1-2-018	0015P2-2-018	2 x 18	0.42	2 x 21.1
30	0030P1-2-009	0030P2-2-009	2 x 9	1.67	2 x 10.6
	0030P1-2-012	0030P2-2-012	2 x 12	1.25	2 x 14.1
	0030P1-2-015	0030P2-2-015	2 x 15	1.00	2 x 17.6
	0030P1-2-018	0030P2-2-018	2 x 18	0.83	2 x 21.2
	0030P1-2-022	0030P2-2-022	2 x 22	0.68	2 x 26.0
50	0050P1-2-009	0050P2-2-009	2 x 9	2.78	2 x 10.2
	0050P1-2-012	0050P2-2-012	2 x 12	2.08	2 x 13.6
	0050P1-2-015	0050P2-2-015	2 x 15	1.67	2 x 17.1
	0050P1-2-018	0050P2-2-018	2 x 18	1.39	2 x 20.4
	0050P1-2-022	0050P2-2-022	2 x 22	1.14	2 x 24.9
80	0080P1-2-010	0080P2-2-010	2 x 10	4.00	2 x 11.5
	0080P1-2-012	0080P2-2-012	2 x 12	3.33	2 x 13.8
	0080P1-2-015	0080P2-2-015	2 x 15	2.67	2 x 17.3
	0080P1-2-018	0080P2-2-018	2 x 18	2.22	2 x 20.7
	0080P1-2-022	0080P2-2-022	2 x 22	1.82	2 x 25.4
120	0120P1-2-012	0120P2-2-012	2 x 12	5.00	2 x 13.4
	0120P1-2-015	0120P2-2-015	2 x 15	4.00	2 x 16.8
	0120P1-2-018	0120P2-2-018	2 x 18	3.33	2 x 20.2
	0120P1-2-022	0120P2-2-022	2 x 22	2.73	2 x 24.5
	0120P1-2-055	0120P2-2-055	2 x 55	1.03	2 x 61.3

Power VA	Part Number		Secondary		
	Primary		Full Load V	Current A	Open Circuit V
	230V				
160	0160P1-2-012		2 x 12	6.67	2 x 13.5
	0160P1-2-015		2 x 15	5.33	2 x 16.6
	0160P1-2-018		2 x 18	4.44	2 x 20.0
	0160P1-2-022		2 x 22	3.64	2 x 24.5
	0160P1-2-030		2 x 30	2.67	2 x 33.5
	0160P1-2-055		2 x 55	1.45	2 x 61.2
225	0225P1-2-012		2 x 12	9.38	2 x 13.1
	0225P1-2-015		2 x 15	7.50	2 x 16.5
	0225P1-2-018		2 x 18	6.25	2 x 19.7
	0225P1-2-022		2 x 22	5.11	2 x 24.2
	0225P1-2-024		2 x 24	4.69	2 x 26.5
300	0225P1-2-030		2 x 30	3.75	2 x 32.8
	0300P1-2-012		2 x 12	12.5	2 x 13.1
	0300P1-2-018		2 x 18	8.33	2 x 19.4
	0300P1-2-022		2 x 22	6.82	2 x 23.8
	0300P1-2-025		2 x 25	6.00	2 x 27.1
	0300P1-2-030		2 x 30	5.00	2 x 32.5
500	0300P1-2-035		2 x 35	4.29	2 x 37.8
	0300P1-2-055		2 x 55	2.73	2 x 59.6
	0500P1-2-020		2 x 20	12.5	2 x 21.5
	0500P1-2-025		2 x 25	10.0	2 x 26.7
	0500P1-2-030		2 x 30	8.33	2 x 32.3
625	0500P1-2-040		2 x 40	6.25	2 x 43.0
	0500P1-2-055		2 x 55	4.55	2 x 59.0
	0625P1-2-018		2 x 18	17.4	2 x 19.3
	0625P1-2-022		2 x 22	14.2	2 x 23.5
	0625P1-2-040		2 x 40	7.81	2 x 42.8
	0625P1-2-045		2 x 45	6.94	2 x 48.3
1000	0625P1-2-050		2 x 50	6.25	2 x 53.8
	0625P1-2-055		2 x 55	5.68	2 x 58.9
	0625P1-4-012		4 x 12	13.0	4 x 12.9
	1000P1-2-018		2 x 18	27.8	2 x 18.8
	1000P1-2-022		2 x 22	22.7	2 x 23.5
	1000P1-2-040		2 x 40	12.5	2 x 42.2
	1000P1-2-045		2 x 45	11.1	2 x 47.5
	1000P1-2-050		2 x 50	10.0	2 x 52.8
	1000P1-2-055		2 x 55	9.09	2 x 58.1
	1000P1-4-022		4 x 22	11.4	4 x 23.5
1000P1-4-028		4 x 28	8.93	4 x 29.3	

Note: Standard encapsulated versions available from 15VA to 500VA.
See page 7 for dimensions and specifications.

Ordering Information

Example: 0030 P1 -2 -010 -K

Power (VA) — 0030

Number of Primaries — P1

— -2 — Secondary Voltage

— -010 — Number of Secondaries

— -K — Polyamid Housing

Standard Mini" Series Toroidal Transformers

- lower strayfield
- high efficiency
- reduced standby current
- low weight
- Dual 115V primaries for parallel or series connections
- Test Voltage Primary - Secondary 4.0 kV
- Ambient operating temp.: +60°C max.
- Insulation system recognized for Class A (105°C) and meets all requirements of Class E (125°C)

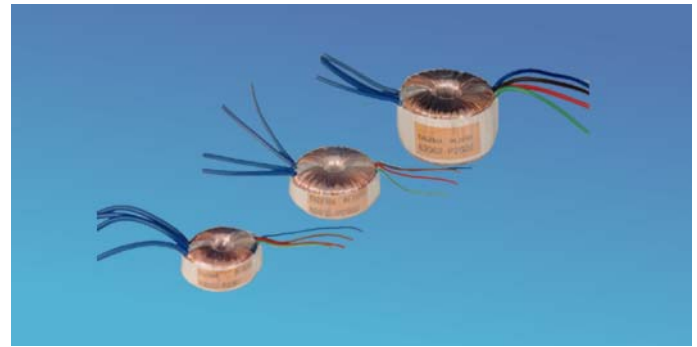

Power VA	Part Number 2 x 115V	Secondary Full Load V	Secondary Current mA	Open Circuit V
1.6	62000	2 x 7	114	2 x 8.9
	62001	2 x 9	89	2 x 11.6
	62002	2 x 12	67	2 x 15.4
	62003	2 x 15	53	2 x 19.3
	62004	2 x 18	44	2 x 23.4
	62005	2 x 22	36	2 x 28.2
3.2	62010	2 x 7	229	2 x 10.2
	62011	2 x 9	178	2 x 13.0
	62012	2 x 12	133	2 x 17.3
	62013	2 x 15	107	2 x 21.4
	62014	2 x 18	89	2 x 25.7
	62015	2 x 22	73	2 x 30.5
5.0	62020	2 x 7	357	2 x 9.7
	62021	2 x 9	278	2 x 12.4
	62022	2 x 12	208	2 x 17.0
	62023	2 x 15	167	2 x 21.3
	62024	2 x 18	139	2 x 25.5
	62025	2 x 22	114	2 x 30.5
7.0	62030	2 x 7	500	2 x 9.5
	62031	2 x 9	389	2 x 12.2
	62032	2 x 12	292	2 x 16.2
	62033	2 x 15	233	2 x 20.3
	62034	2 x 18	194	2 x 24.3
	62035	2 x 22	159	2 x 29.7
10	62040	2 x 7	714	2 x 8.3
	62041	2 x 9	556	2 x 10.8
	62042	2 x 12	417	2 x 14.4
	62043	2 x 15	333	2 x 18.0
	62044	2 x 18	278	2 x 21.7
	62045	2 x 22	227	2 x 26.3

Power VA	Part Number 2 x 115V	Secondary Full Load V	Secondary Current mA	Open Circuit V
15	62050	2 x 7	1071	2 x 8.9
	62051	2 x 9	833	2 x 11.1
	62052	2 x 12	625	2 x 14.8
	62053	2 x 15	500	2 x 18.5
	62054	2 x 18	417	2 x 22.2
	62055	2 x 22	341	2 x 27.2
25	62060	2 x 7	1785	2 x 8.3
	62061	2 x 9	1377	2 x 10.7
	62062	2 x 12	1041	2 x 14.2
	62063	2 x 15	832	2 x 17.8
	62064	2 x 18	694	2 x 21.4
	62065	2 x 22	568	2 x 26.2
35	62070	2 x 7	2500	2 x 8.2
	62071	2 x 9	1944	2 x 10.6
	62072	2 x 12	1458	2 x 14.0
	62073	2 x 15	1166	2 x 17.6
	62074	2 x 18	972	2 x 20.9
	62075	2 x 22	795	2 x 25.7
50	62080	2 x 7	3571	2 x 8.1
	62081	2 x 9	2777	2 x 10.4
	62082	2 x 12	2083	2 x 13.8
	62083	2 x 15	1666	2 x 17.3
	62084	2 x 18	1388	2 x 20.7
	62085	2 x 22	1136	2 x 25.4

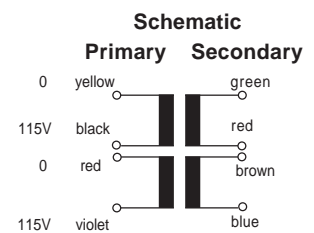
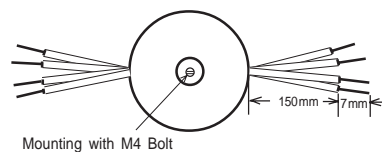

Standard Output (Electrical measurements @ 20°C ambient temperature)

Power VA	Dimensions OD x ID x H mm	Weight grams	No Load Regulation $\Delta V/\text{Sec.}$ (%)	Δt °C	Efficiency %	No Load mA (typ.)	230V Fuse mA	Secondary Power (Max.)				
								VA	$\Delta V / \text{sec.}$ %	Δt °C	Efficiency %	Rec. Fuse mA
1.6	37.5x7.0x17.0	71	29	10	77	1.0	32	2.0	60	30	60	32
3.2	42.0x7.0x17.5	89	41	20	70	1.5	32	3.7	80	40	50	50
5.0	47.0x6.0x18.0	115	45	29	70	2.0	50	5.5	80	40	50	63
7.0	47.0x6.8x21.5	145	34	25	74	3.0	63	7.5	70	40	60	80
10	53.5x6.8x23.5	216	20	24	82	3.0	80	12.0	60	45	60	100
15	57.5x7.0x24.0	262	23	27	81	4.0	100	16.0	60	40	65	125
25	58.0x13.8x34.5	388	19.0	28	84	5.0	160	--	--	--	--	--
35	72.0x17.0x33.5	453	17.7	31	85	7.0	200	--	--	--	--	--
50	78.0x22.5x35.0	670	15.5	30	86	8.0	315	--	--	--	--	--



Toroidal PC Transformers • 1.6VA - 50VA

- Dual 115V or 120V primaries for parallel or series connection
- low profile - small size and low weight
- low magnetic interference field
- low noise
- high efficiency
- reduced "standby" current
- ease of mounting - M4 central bush
- Test Voltage Primary - Secondary 4.0 kV
- Ambient operating temp.: +60°C max. 1.6VA - 25VA; +40°C max. 35VA - 50VA
- Insulation system recognized for Class A (105°C) and meets all requirements of Class E (125°C)
- UL & VDE recognized

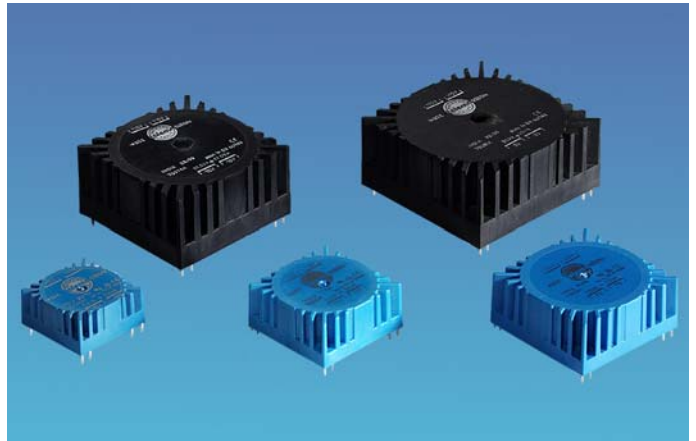

Standard Outputs (Electrical measurements @ 20°C ambient temperature)

Power VA	Weight Cu gram	No Load Regulation $\Delta V/\text{Sec.}$ (%)	Δt °C	Efficiency %	No Load mA (typ.)	230V Fuse mA	Secondary Range (Max.)				
							VA	$\Delta V / \text{sec.}$ %	Δt °C	Efficiency %	Rec. Fuse mA
1.6	82	29	10	77	1.0	32	2.0	60	30	60	32
3.2	110	43	20	70	1.5	32	3.7	80	40	50	50
5.0	144	40	29	68	2.0	50	5.5	80	40	50	63
7.0	174	34	25	74	3.0	63	7.5	70	40	60	80
10	252	20	24	82	3.0	80	12.0	60	45	60	100
15	304	23	27	80	4.0	100	16.0	60	40	65	125
25	435	19.0	28	83	5.0	160	--	--	--	--	--
35	525	17.7	31	81	7.0	200	--	--	--	--	--
50	685	15.5	30	86	8.0	315	--	--	--	--	--

Power VA	Part Number		Secondary		
	2 x 115V	2 x 120V	Full Load V	Current mA	Open Circuit V
1.6	70000K	72400K	2 x 7	114	2 x 8.9
	70001K	72401K	2 x 9	89	2 x 11.6
	70002K	72402K	2 x 12	67	2 x 15.4
	70003K	72403K	2 x 15	53	2 x 19.3
	70004K	72404K	2 x 18	44	2 x 23.4
	70005K	72405K	2 x 22	36	2 x 28.2
3.2	70010K	72410K	2 x 7	229	2 x 10.2
	70011K	72411K	2 x 9	178	2 x 13.0
	70012K	72412K	2 x 12	133	2 x 17.3
	70013K	72413K	2 x 15	107	2 x 21.4
	70014K	72414K	2 x 18	89	2 x 25.7
	70015K	72415K	2 x 22	73	2 x 31.3
5.0	70020K	72420K	2 x 7	357	2 x 9.7
	70021K	72421K	2 x 9	278	2 x 12.4
	70022K	72422K	2 x 12	208	2 x 17.0
	70023K	72423K	2 x 15	167	2 x 21.3
	70024K	72424K	2 x 18	139	2 x 25.5
	70025K	72425K	2 x 22	114	2 x 30.5
7.0	70030K	72430K	2 x 7	500	2 x 9.5
	70031K	72431K	2 x 9	389	2 x 12.2
	70032K	72432K	2 x 12	292	2 x 16.2
	70033K	72433K	2 x 15	233	2 x 20.3
	70034K	72434K	2 x 18	194	2 x 24.3
	70035K	72435K	2 x 22	159	2 x 29.7
10	70040K	72440K	2 x 7	714	2 x 8.3
	70041K	72441K	2 x 9	556	2 x 10.8
	70042K	72442K	2 x 12	417	2 x 14.4
	70043K	72443K	2 x 15	333	2 x 18.0
	70044K	72444K	2 x 18	278	2 x 21.7
	70045K	72445K	2 x 22	227	2 x 26.3

Power VA	Part Number		Secondary		
	2 x 115V	2 x 120V	Full Load V	Current mA	Open Circuit V
15	70050K	72450K	2 x 7	1071	2 x 8.9
	70051K	72451K	2 x 9	833	2 x 11.1
	70052K	72452K	2 x 12	625	2 x 14.8
	70053K	72453K	2 x 15	500	2 x 18.5
	70054K	72454K	2 x 18	417	2 x 22.2
	70055K	72455K	2 x 22	341	2 x 27.2
25	70060K	72460K	2 x 7	1785	2 x 8.3
	70061K	72461K	2 x 9	1377	2 x 10.7
	70062K	72462K	2 x 12	1041	2 x 14.3
	70063K	72463K	2 x 15	832	2 x 17.8
	70064K	72464K	2 x 18	694	2 x 21.4
	70065K	72465K	2 x 22	568	2 x 26.2
35	70070K	72470K	2 x 7	2500	2 x 8.0
	70071K	72471K	2 x 9	1944	2 x 10.6
	70072K	72472K	2 x 12	1458	2 x 14.0
	70073K	72473K	2 x 15	1166	2 x 17.6
	70074K	72474K	2 x 18	972	2 x 20.9
	70075K	72475K	2 x 22	795	2 x 25.7
50	70080K	72480K	2 x 7	3571	2 x 8.1
	70081K	72481K	2 x 9	2777	2 x 10.4
	70082K	72482K	2 x 12	2083	2 x 13.9
	70083K	72483K	2 x 15	1666	2 x 17.3
	70084K	72484K	2 x 18	1388	2 x 20.8
	70085K	72485K	2 x 22	1136	2 x 25.4

Primaries and secondaries for parallel or series connection.

Dimensions and schematics on page 12

Toroidal PC Transformers • 90VA - 160VA

Features

- 115V or 230V primary, 50/60 Hz
- low magnetic interference field
- low noise
- high efficiency
- reduced “standby” current
- Test Voltage Primary - Secondary 4.0 kV
- Ambient operating temp.: +40°C max.
- Insulation system recognized for Class A (105°C) and meets all requirements of Class E (125°C)

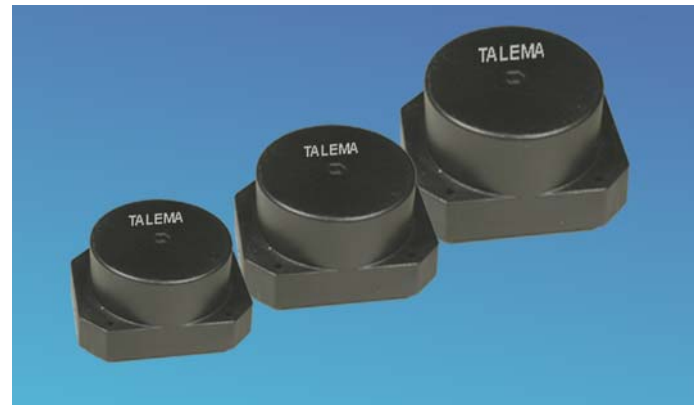

Standard Outputs (Electrical measurements @ 20°C ambient temperature)

Power VA	Bestellnr. - Part Number		Secondary - Full Load V	Efficiency %	Regulation $\Delta V/\text{sec}$ @ 20°C	Schematic Primary - Secondary
	115V	230V				
90	6420K	6520K	2 X 7	89	11.5	
	6421K	6521K	2 X 9			
	6422K	6522K	2 X 12			
	6423K	6523K	2 X 15			
	6424K	6524K	2 X 18			
	6425K	6525K	2 X 24			
	6426K	6526K	2 X 30			
110	6430K	6530K	2 X 7	87	10.1	
	6431K	6531K	2 X 9			
	6432K	6532K	2 X 12			
	6433K	6533K	2 X 15			
	6434K	6534K	2 X 18			
	6435K	6535K	2 X 24			
	6436K	6536K	2 X 30			
160	6440K	6540K	2 X 7	90	9.5	
	6441K	6541K	2 X 9			
	6442K	6542K	2 X 12			
	6443K	6543K	2 X 15			
	6444K	6544K	2 X 18			
	6445K	6545K	2 X 24			
	6446K	6546K	2 X 30			

Note: 160VA only - Secondary pin connection for 2 x 7V will be 15+16, 18+19 and 24+25, 27+28

Options

- Dual primaries and multiple secondaries with different voltage ratings
- Magnetic and/or electrostatic shielding
- Fuses
- Temperature switches

Dimensions on page 12

Dimensions - 7XXXX Series					
Power VA	Dimensions L x W x H mm	Pin Layout		Weight gram	Pin Availability
		XY mm	Pin Size mm		
1.6	39.6x39.6x18.5	35.56	1.0x0.5	82	1 - 16
3.2	44.7x44.7x19.5	40.64	1.0x0.5	110	1 - 18
5.0	49.7x49.7x19.5	45.72	1.0x0.5	144	1 - 18
7.0	49.7x49.7x23.1	45.72	1.0x0.5	174	1 - 18
10	55.0x55.0x26.0	50.80	1.0x0.5	252	1 - 18
15	60.0x60.0x26.3	55.88	1.0x0.5	304	1 - 20
25	60.0x60.0x37.5	55.88	1.0x0.5	435	1 - 20
35	72.0x72.0x37.5	66.04	Ø 1.3	525	1 - 26
50	82.4x82.4x37.5	76.20	Ø 1.3	685	1 - 34

Example of Schematic to customer specification			
Special Voltages - 1.6VA to 50VA			
Primary	Pin No.	Secondary	Pin No.
1) 100 - 120V	3 - 4	1) 7 - 120V	14 - 13
2) 100 - 120V	5 - 6	2) 7 - 120V	12 - 11
3) 5 - 30V	7 - 2	3) 7 - 42V	10 - 15
4) 5 - 30V	8 - 1	4) 7 - 42V	9 - 16
5) 230V	3 - 6		

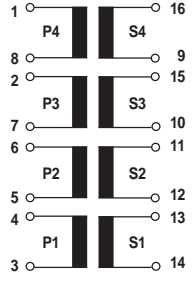

Other special voltages available upon request

70000 & 72400 Series
Pin Side

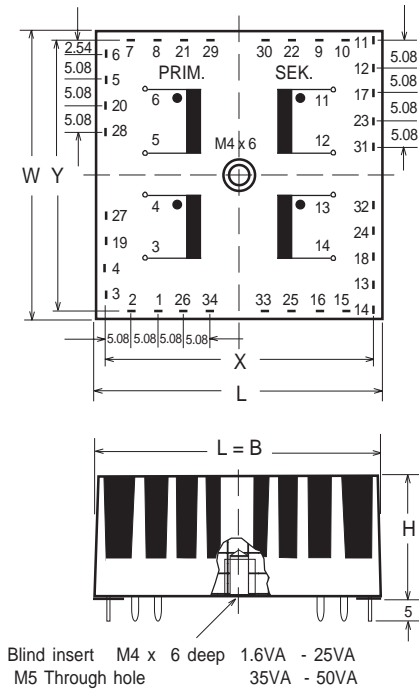

6400K & 6500K Series
Pin Side

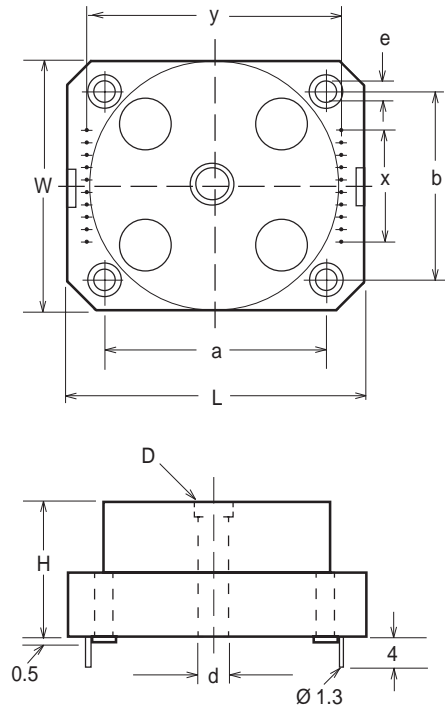

Power VA	Dimensions - 6400K & 6500K Series										Weight kg
	L ±0.3	W ±0.2	H ±0.2	x ±0.2	y ±0.2	a ±0.2	b ±0.2	d ±0.2	e ±0.2	D (SW-Hex) ±0.2	
90	100.0	83.5	43.4	9 x 5	90	70	70	5.1	3.4	7	1.00
110	112.2	93.3	50.5	11 x 5	100	80	80	6.1	3.4	10	1.35
160	120.3	103.3	55.5	13 x 5	110	90	90	6.1	3.4	10	1.80

Organization



Talema-Nuvotem- Ireland



Czech - Production

THE TALEMA GROUP

BOARD OF DIRECTORS
(Shareholders)
C.E.O.
Martin Park

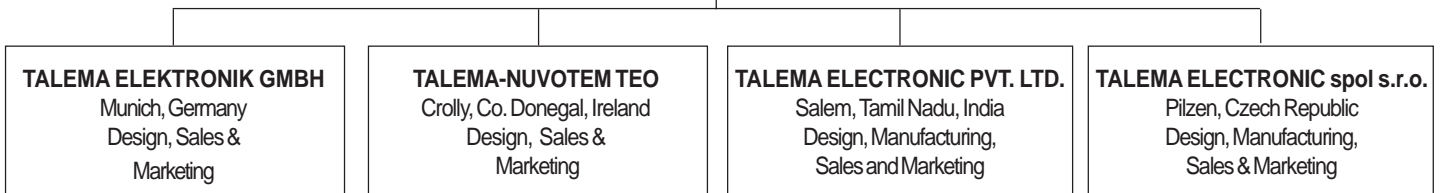

Employees	
Management	20
Technical Design Staff	26
Administrative & Clerical	44
Sales & Marketing	17
Factory Floor Staff	79
Quality Control	77
Stores, Shipping & Core Production	84
Security & Housekeeping	27
Direct Operators	<u>1,016</u>
TOTAL	1,390

TALEMA ELECTRONIC PVT. LTD.
Plant 1
Adm. & Manufacturing
Transformers

TALEMA ELECTRONIC PVT. LTD.
Plant 2
Manufacturing
Communications Products

TALEMA ELECTRONIC PVT. LTD.
Plant 3
Manufacturing
High Frequency Products



Production



Hybrid/Module Fabrication



India - Headquarters



Production - Telecom



Clean Room



Production - Inductive Components

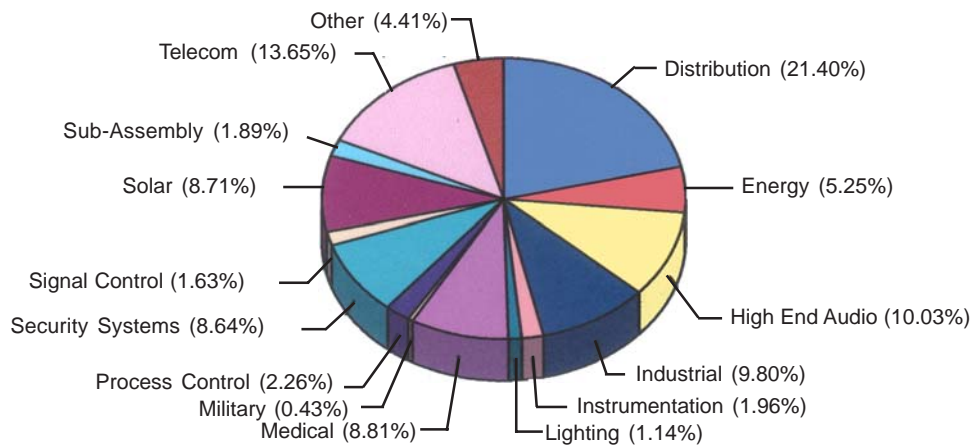

- **Medical Equipment**
 - Apnea Therapy
 - Respirators
 - Hemodialysis
 - DNA Analysis
 - Stimulation Current
 - Low Temperature Treatment
 - Monitoring Systems
 - X-ray Equipment
- **Telecom**
 - ISDN Extension - Terminal Equipment
 - ISDN Adapter
 - ISDN Modem and Router
 - LAN / WAN Components
 - Ethernet / S₂M Transmission Systems
- **Industrial Applications**
 - Control Systems
 - Power Supplies
 - Access Control
 - Fire Alarm Systems
 - Soldering and Welding Equipment
 - SMPS
 - Measuring Equipment
 - Traffic Control Systems
 - Electric Motor Controls
 - Radio Equipment
- **Automotive Industry**
 - Fallback/Safety Systems
 - On-board Electronics
- **Computer**
 - Power Supplies
 - Data Line Applications
- **High End**
 - Pre-amplifier / Power Amplifier
 - CD Player
- **Halogen Lighting**
 - Large Scale Lighting
 - Standard Systems
 - Traffic control / Traffic Lights
- **Distribution**
 - RS Components
 - Schukat
 - Bürklin
 - Rutronik

Authorised Talema Sales Representatives and Distributors

Sales Representatives

Germany

PLZ 1, 4,5, 6, 8 & 9
TALEMA ELEKTRONIK GMBH
Sembdnerstr. 5, Postfach 2523
82110 Germering
Tel: Int. + 49 89 841 00 - 0
Fax: Int. + 49 89 841 00 25
Email: info@talema.de

Australia

TORTECH PTY. LTD.
POB 194
North Strathfield,
Sydney, N.S.W. 2137
Tel: Int. + 61 2 9642 6003
Fax: Int. + 61 2 9642 6127
E-Mail: tortech@ozemail.com.au
Web Site: www.tortech.com.au

France

E.S.I.A
5-7 Place Marcel Rebuffat
Courtaboeuf 7 Villejust
91971 Courtaboeuf Cedex
Tel: Int. + 33 1 6931 4410
Fax: Int. + 33 1 6931 4425
E-Mail: esia@wanadoo.fr
Web Site: www.esia.fr

UK

DELTA COMPONENTS LTD.
Delta House,
Unit T3, Fircroft Way,
Edenbridge, Kent, TN8 6EL
England.
Tel: Int. + 44 1732 865 435
Fax: Int. + 44 1732 863 514
sales@deltacomponents.com
www.deltacomponents.com

PLZ 2 & 3 (less 35 & 36)

H. J. MERCK & Co. GmbH
Hasenhöhe 128
22587 Hamburg
Tel: Int. + 49 40 87 08 63-0
Fax: Int. + 49 40 87 08 63-33
E-mail: info@hj-merck.de

Benelux

ISATRONICK B.V.B.A.
Doolhoflaan 17
B-2640 Mortsel
Tel: Int. + 32 3 448 1976
Fax: Int. + 32 3 448 1195
E-Mail: info@isatronick.be
Web Site: www.isatronick.be

Spain

Oscar Tejedor Badia
Urb. Can Barri,
Carrer de la Rosa 3,
08415-Bigues i Reills,
Barcelona, Spain.
Tel + 34 93 865 7106.
Email: spain@nuvotem.com

PLZ 7

BERND BIELER
Industrievertretung
Max-Eyth-Straße 1
72379 Hechingen
Tel: Int. + 49 7471 1804-0
Fax: Int. + 49 7471 1804-10
E-mail: bieler@bernd-bieler.de

Denmark

NORDTEK DANMARK
Horsensvej 134
DK-8300 Odder
Tel: Int. + 45 86 554 344
Fax: Int. + 45 86 554 644
E-Mail: post@nordtek.dk
Web Site: www.nordtek.dk

Sweden

ORNATUS AB
Stockholmsvägen 26
SE-194 54 UPPLANDS VÄSBY
SWEDEN
Tel: +46 8 444 39 70
Fax: +46 8 444 39 79
Email: info@ornatus.se
Website: http://www.ornatus.se

Austria

TALEMA ELEKTRONIK GMBH
Sembdnerstr. 5, Postfach 2523
82110 Germering
Tel: Int. + 49 89 841 00 - 0
Fax: Int. + 49 89 841 00 25

Italy

TECHNOLASA ELETTRONICA
Via Macello, 65/B
I-39100 Bolzano
Tel: Int. + 39 0471 305 400
Fax: Int. + 39 0471 305 444
E-Mail: sales@technolasa.com

Switzerland

BTB COMPONENTS AG
Im Chlösterli 4
CH-8902 Urdorf
Tel: Int. + 41 44 734 4888
Fax: Int. + 41 44 734 4892
E-mail: info@btbcomponents.ch

Distributors

Germany

BÜRKLIN OHG MÜNCHEN
Schillerstr. 41
80336 München
Tel: Int.+49 89 558 75-0
Fax: Int.+49 89 558 75-421
E-Mail: info@buerklin.de
Web: www.buerklin.com

**SCHUKAT ELECTRONIC
VERTRIEBS GMBH**
Daimlerstraße 26
40789 Monheim
Tel: Int.+49 2173 9505
Fax: Int.+49 2173 950999
Web: www.schukat.com

Italy

RUTRONIK ITALIA S.r.l
21, Via Caldera
Centro Direzionale S.Siro
20153 Milano
Tel: Int.+39 02 40951 1
Fax: Int.+39 02 40951 224
E-Mail: MI@rutronik.com
Web: www.rutronik.com

Switzerland

**RUTRONIK ELEKTRONISCHE
BAUELEMENTE AG**
Hözlizwisenstraße 5
CH-8604 Volketswil
Tel: Int.+41 44 947 3737
Fax: Int.+41 44 947 3747
E-Mail: rutronik_ch@rutronik.com

BÜRKLIN OHG DÜSSELDORF

Hoherweg 245
40231 Düsseldorf
Tel: Int.+49 211 9067-0
Fax: Int.+49 211 9067-125
E-Mail: info@buerklin.de
Web: www.buerklin.com

RUTRONIK ELEKTRONISCHE

BAUELEMENTE GMBH
Industriestraße 2
75228 Ispringen/Pforzheim
Tel: Int.+49 7231 801-0
Fax: Int.+49 7231 82282
E-Mail: rutronik@rutronik.com
Web: www.rutronik.com

UK

RS COMPONENTS LTD.
Birchington Road
Corby
Northants, NN17 9RS
Tel: Int.+44 8457 201201
Fax: Int.+44 845 850 9911
www.rs-components.com

Sales & Marketing, Design and Manufacturing Facilities

Germany

TALEMA ELEKTRONIK GMBH
Sembdnerstr. 5, Postfach 2523
82110 Germering
Tel: Int. + 49 89 - 841 00 - 0
Fax: Int. + 49 89 - 841 00 25
Email: info@talema.de
Web Site: www.talema.de

Ireland

NUVOTEM TEO.
Crolley
Co. Donegal
Tel: Int. + 353 74 - 954 8666
Fax: Int. + 353 74 - 954 8139
Email: info@nuvotem.com
Web Site: www.nuvotem.com

USA

Talema Group, LLC
650 Holmes Lane,
Rolla,
MO 65401
Tel: Int.+1 573 263-0659,
Email: sales@talemagroup.com
Web Site: www.talema-nuvotem.com

India

Talema Electronic (India) Pvt. Ltd.
No. 221, I & II Floor, K.J.Plaza,
Meyanoor Main Road, Salem-636 004, Tamil Nadu, India
Tel: ++91-427-2433 000
Fax: ++91-427-2433 109
Email: talema@talemaindia.net

Eastern Europe & Czech Republic

NT MAGNETICS s.r.o.
Chebská 27
322 00 Plzeň
Tel: Int. + 420 377 - 338 351
Fax: Int. + 420 377 - 338 350
Email: talema@talema.cz
Web Site: www.ntmagnetics.cz

The Talema Group – World Wide Toroidal Specialists

www.talema-nuvotem.com



nt
magnetics

nuvotem

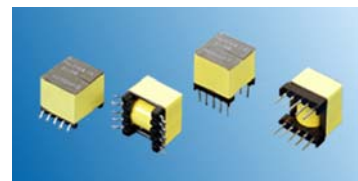
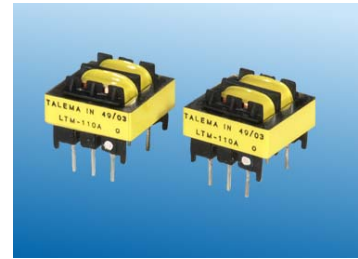
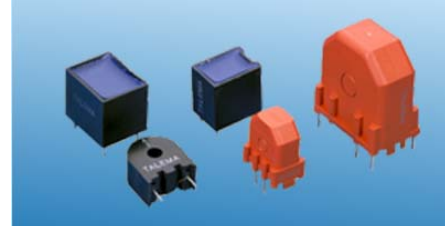
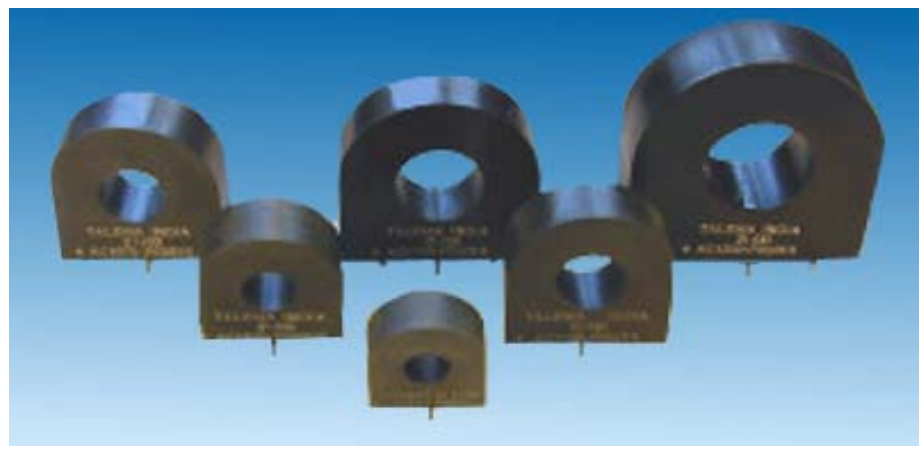

Summary TOTAL PROGRAM

SECTION 1

- TOROIDAL 50/60Hz TRANSFORMERS
- TOROIDAL PCB TRANSFORMERS

SECTION 3

- ELEVEN GOOD REASONS TO SELECT TALEMA TOROIDAL TRANSFORMERS

SECTION 4

- CHOKES, INDUCTORS AND TRANSFORMERS FOR POWER APPLICATIONS

SECTION 5

- COMPONENTS FOR TELECOMMUNICATIONS AND DATA LINE TECHNOLOGY

SECTION 6

- CURRENT COMPENSATED EMI NOISE SUPPRESSION CHOKES

SECTION 7

- CURRENT SENSE TRANSFORMERS AND INDUCTORS

SECTION 8

- LAN MAGNETIC COMPONENTS FOR ETHERNET APPLICATIONS

SECTION 9

- T1/E1/CEPT-PR1 - T3/DS3/E3/STS-1 FOR TELECOMMUNICATION PRODUCTS

SECTION 10

- U INTERFACE TRANSFORMERS FOR COMMUNICATIONS AND DATA LINE TECHNOLOGY

SECTION 11

- TRANSFORMERS FOR BROADBAND ACCESS AND FIBRE CHANNEL INTERFACE