

D2HW

Sealed Ultra Subminiature Basic Switch

Smallest sealed snap-action switch in the industry with a very long stroke for reliable ON/OFF action

- The case dimensions are 78% of conventional models, contributing to down-sizing of mechanical modules.
- Extra-long stroke even without levers. (OT reference value: 1.4 mm).
- Made of environmentally-friendly materials. All models are lead-free, including molded lead wire models.

RoHS Compliant

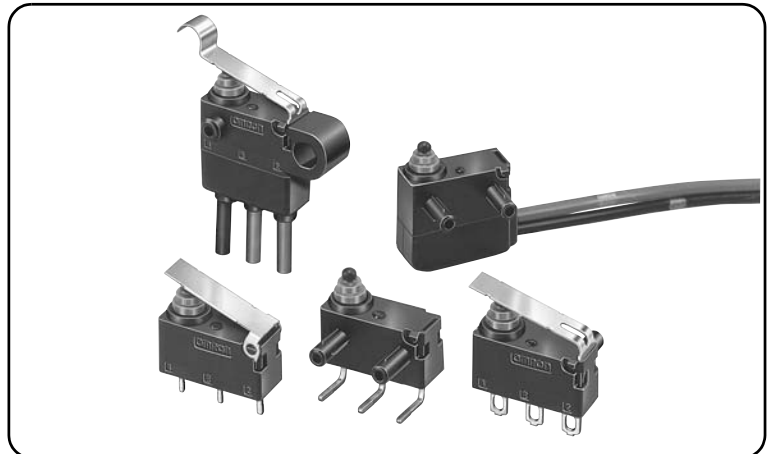

D
2
H
W

Model Number Legend

D2HW - 1 2 3 4 5 6 7

1. Mounting Structure

- A : Without posts (base-mounting)
- BR : Long post on right
- BL : Long post on left
- C : M3-screw mounting models
- ER : Short post on right
- EL : Short post on left

2. Ratings

- 2 : 5 VDC 1mA to 12 VDC 2A

3. Actuator

- 0 : Pin plunger
- 1 : Hinge lever
- 2 : Long hinge lever
- 3 : Simulated roller lever
- 4 : Hinge roller lever
- 5 : Straight leaf lever
- 6 : Leaf lever
- 7 : Simulated roller leaf lever
- 8 : Long leaf lever

4. Contact form

- 1 : SPDT
- 2 : SPST-NC (Molded lead wire models only)
- 3 : SPST-NO (Molded lead wire models only)

5. Terminals

- D, DS : PCB terminals (Straight)
- DR, DRS : PCB Terminals (Right-angled)
- DL, DLS : PCB Terminals (Left-angled)
- H, HS : Solder terminals
- M, MS : Molded lead wires downwards
- MR, MRS : Molded lead wires on right-side
- ML, MLS : Molded lead wires on left-side







Note. UL/CSA approved versions are available.
In this case, a "S" will be added to the end of the model number.
The Lead wire is a UL approved wire (AWG24, UL1007).







6. Special Specification

7. Special Industry Specification

List of Models

●PCB-mounted Models











List of Models				Long post on right 	Short post on right 
Actuator	Terminals		Contact form		
Pin plunger 	For PCB	Straight	SPDT	-	-
		Angled		D2HW-BR201DR	D2HW-ER201DR
Hinge lever 		Straight		-	-
		Angled		D2HW-BR211DR	D2HW-ER211DR
Long hinge lever 		Straight		-	-
		Angled		D2HW-BR221DR	D2HW-ER221DR
Simulated roller hinge lever 	Straight	-	-		
	Angled	D2HW-BR231DR	D2HW-ER231DR		

List of Models				Long post on left 	Short post on left 	Without posts 
Actuator	Terminals		Contact form			
Pin plunger 	For PCB	Straight	SPDT	-	-	D2HW-A201D
		Angled		D2HW-BL201DL	D2HW-EL201DL	-
Hinge lever 		Straight		-	-	D2HW-A211D
		Angled		D2HW-BL211DL	D2HW-EL211DL	-
Long hinge lever 		Straight		-	-	D2HW-A221D
		Angled		D2HW-BL221DL	D2HW-EL221DL	-
Simulated roller hinge lever 	Straight	-	-	D2HW-A231D		
	Angled	D2HW-BL231DL	D2HW-EL231DL	-		

Note1. Angled terminals and posts are the same direction.

Note2. "S" is added to the end of the model number for the UL/CSA-approved version Consult your OMRON sales representative for details.













●Models with Solder Terminals or Molded Lead Wires

Actuator	Terminals	Contact form	List of Models		
			Long post on right 	Short post on right 	
Pin plunger 	Solder	Downwards	SPDT	D2HW-BR201H	D2HW-ER201H
			SPDT	D2HW-BR201M	D2HW-ER201M
			SPST-NC	D2HW-BR202M	D2HW-ER202M
	Molded lead wires	Right-side	SPST-NO	D2HW-BR203M	D2HW-ER203M
			SPST-NC	D2HW-BR202MR	D2HW-ER202MR
			SPST-NO	D2HW-BR203MR	D2HW-ER203MR
		Left-side	SPST-NC	D2HW-BR202ML	D2HW-ER202ML
			SPST-NO	D2HW-BR203ML	D2HW-ER203ML
			SPST-NO	D2HW-BR203ML	D2HW-ER203ML
Hinge lever 	Solder	Downwards	SPDT	D2HW-BR211H	D2HW-ER211H
			SPDT	D2HW-BR211M	D2HW-ER211M
			SPST-NC	D2HW-BR212M	D2HW-ER212M
	Molded lead wires	Right-side	SPST-NO	D2HW-BR213M	D2HW-ER213M
			SPST-NC	D2HW-BR212MR	D2HW-ER212MR
			SPST-NO	D2HW-BR213MR	D2HW-ER213MR
		Left-side	SPST-NC	D2HW-BR212ML	D2HW-ER212ML
			SPST-NO	D2HW-BR213ML	D2HW-ER213ML
			SPST-NO	D2HW-BR213ML	D2HW-ER213ML
Long hinge lever 	Solder	Downwards	SPDT	D2HW-BR221H	D2HW-ER221H
			SPDT	D2HW-BR221M	D2HW-ER221M
			SPST-NC	D2HW-BR222M	D2HW-ER222M
	Molded lead wires	Right-side	SPST-NO	D2HW-BR223M	D2HW-ER223M
			SPST-NC	D2HW-BR222MR	D2HW-ER222MR
			SPST-NO	D2HW-BR223MR	D2HW-ER223MR
		Left-side	SPST-NC	D2HW-BR222ML	D2HW-ER222ML
			SPST-NO	D2HW-BR223ML	D2HW-ER223ML
			SPST-NO	D2HW-BR223ML	D2HW-ER223ML
Simulated roller hinge lever 	Solder	Downwards	SPDT	D2HW-BR231H	D2HW-ER231H
			SPDT	D2HW-BR231M	D2HW-ER231M
			SPST-NC	D2HW-BR232M	D2HW-ER232M
	Molded lead wires	Right-side	SPST-NO	D2HW-BR233M	D2HW-ER233M
			SPST-NC	D2HW-BR232MR	D2HW-ER232MR
			SPST-NO	D2HW-BR233MR	D2HW-ER233MR
		Left-side	SPST-NC	D2HW-BR232ML	D2HW-ER232ML
			SPST-NO	D2HW-BR233ML	D2HW-ER233ML
			SPST-NO	D2HW-BR233ML	D2HW-ER233ML
Hinge roller lever 	Solder	Downwards	SPDT	D2HW-BR241H	D2HW-ER241H
			SPDT	D2HW-BR241M	D2HW-ER241M
			SPST-NC	D2HW-BR242M	D2HW-ER242M
	Molded lead wires	Right-side	SPST-NO	D2HW-BR243M	D2HW-ER243M
			SPST-NC	D2HW-BR242MR	D2HW-ER242MR
			SPST-NO	D2HW-BR243MR	D2HW-ER243MR
		Left-side	SPST-NC	D2HW-BR242ML	D2HW-ER242ML
			SPST-NO	D2HW-BR243ML	D2HW-ER243ML
			SPST-NO	D2HW-BR243ML	D2HW-ER243ML
Straight leaf lever 	Solder	Downwards	SPDT	D2HW-BR251H	D2HW-ER251H
			SPDT	D2HW-BR251M	D2HW-ER251M
			SPST-NC	D2HW-BR252M	D2HW-ER252M
	Molded lead wires	Right-side	SPST-NO	D2HW-BR253M	D2HW-ER253M
			SPST-NC	D2HW-BR252MR	D2HW-ER252MR
			SPST-NO	D2HW-BR253MR	D2HW-ER253MR
		Left-side	SPST-NC	D2HW-BR252ML	D2HW-ER252ML
			SPST-NO	D2HW-BR253ML	D2HW-ER253ML
			SPST-NO	D2HW-BR253ML	D2HW-ER253ML
Leaf lever 	Solder	Downwards	SPDT	D2HW-BR261H	D2HW-ER261H
			SPDT	D2HW-BR261M	D2HW-ER261M
			SPST-NC	D2HW-BR262M	D2HW-ER262M
	Molded lead wires	Right-side	SPST-NO	D2HW-BR263M	D2HW-ER263M
			SPST-NC	D2HW-BR262MR	D2HW-ER262MR
			SPST-NO	D2HW-BR263MR	D2HW-ER263MR
		Left-side	SPST-NC	D2HW-BR262ML	D2HW-ER262ML
			SPST-NO	D2HW-BR263ML	D2HW-ER263ML
			SPST-NO	D2HW-BR263ML	D2HW-ER263ML
Simulated roller leaf lever 	Solder	Downwards	SPDT	D2HW-BR271H	D2HW-ER271H
			SPDT	D2HW-BR271M	D2HW-ER271M
			SPST-NC	D2HW-BR272M	D2HW-ER272M
	Molded lead wires	Right-side	SPST-NO	D2HW-BR273M	D2HW-ER273M
			SPST-NC	D2HW-BR272MR	D2HW-ER272MR
			SPST-NO	D2HW-BR273MR	D2HW-ER273MR
		Left-side	SPST-NC	D2HW-BR272ML	D2HW-ER272ML
			SPST-NO	D2HW-BR273ML	D2HW-ER273ML
			SPST-NO	D2HW-BR273ML	D2HW-ER273ML
Long leaf lever 	Solder	Downwards	SPDT	D2HW-BR281H	D2HW-ER281H
			SPDT	D2HW-BR281M	D2HW-ER281M
			SPST-NC	D2HW-BR282M	D2HW-ER282M
	Molded lead wires	Right-side	SPST-NO	D2HW-BR283M	D2HW-ER283M
			SPST-NC	D2HW-BR282MR	D2HW-ER282MR
			SPST-NO	D2HW-BR283MR	D2HW-ER283MR
		Left-side	SPST-NC	D2HW-BR282ML	D2HW-ER282ML
			SPST-NO	D2HW-BR283ML	D2HW-ER283ML
			SPST-NO	D2HW-BR283ML	D2HW-ER283ML

Note1. The length of standard lead wires (AVSS 0.5) for molded lead wire models shown above is 30 cm.

Note2. "S" is added to the end of the model number for the UL/CSA-approved version. The lead wire models are UL approved wires (AWG24, UL1007). Consult your OMRON sales representative for details.

●Models with Solder Terminals or Molded Lead Wires

Actuator	Terminals	Contact form	List of Models			
			Long post on left 	Short post on left 	M3-screw mounting 	
Pin plunger 	Solder	Molded lead wires	SPDT	D2HW-BL201H	D2HW-EL201H	D2HW-C201H
			SPDT	D2HW-BL201M	D2HW-EL201M	D2HW-C201M
	Downwards		SPST-NC	D2HW-BL202M	D2HW-EL202M	D2HW-C202M
			SPST-NO	D2HW-BL203M	D2HW-EL203M	D2HW-C203M
	Right-side		SPST-NC	D2HW-BL202MR	D2HW-EL202MR	D2HW-C202MR
			SPST-NO	D2HW-BL203MR	D2HW-EL203MR	D2HW-C203MR
	Left-side	SPST-NC	D2HW-BL202ML	D2HW-EL202ML	-	
		SPST-NO	D2HW-BL203ML	D2HW-EL203ML	-	
	Hinge lever 	Solder	Molded lead wires	SPDT	D2HW-BL211H	D2HW-EL211H
SPDT				D2HW-BL211M	D2HW-EL211M	D2HW-C211M
Downwards		SPST-NC		D2HW-BL212M	D2HW-EL212M	D2HW-C212M
		SPST-NO		D2HW-BL213M	D2HW-EL213M	D2HW-C213M
Right-side		SPST-NC		D2HW-BL212MR	D2HW-EL212MR	D2HW-C212MR
		SPST-NO		D2HW-BL213MR	D2HW-EL213MR	D2HW-C213MR
Left-side		SPST-NC	D2HW-BL212ML	D2HW-EL212ML	-	
		SPST-NO	D2HW-BL213ML	D2HW-EL213ML	-	
Long hinge lever 		Solder	Molded lead wires	SPDT	D2HW-BL221H	D2HW-EL221H
	SPDT			D2HW-BL221M	D2HW-EL221M	D2HW-C221M
	Downwards	SPST-NC		D2HW-BL222M	D2HW-EL222M	D2HW-C222M
		SPST-NO		D2HW-BL223M	D2HW-EL223M	D2HW-C223M
	Right-side	SPST-NC		D2HW-BL222MR	D2HW-EL222MR	D2HW-C222MR
		SPST-NO		D2HW-BL223MR	D2HW-EL223MR	D2HW-C223MR
	Left-side	SPST-NC	D2HW-BL222ML	D2HW-EL222ML	-	
		SPST-NO	D2HW-BL223ML	D2HW-EL223ML	-	
	Simulated roller hinge lever 	Solder	Molded lead wires	SPDT	D2HW-BL231H	D2HW-EL231H
SPDT				D2HW-BL231M	D2HW-EL231M	D2HW-C231M
Downwards		SPST-NC		D2HW-BL232M	D2HW-EL232M	D2HW-C232M
		SPST-NO		D2HW-BL233M	D2HW-EL233M	D2HW-C233M
Right-side		SPST-NC		D2HW-BL232MR	D2HW-EL232MR	D2HW-C232MR
		SPST-NO		D2HW-BL233MR	D2HW-EL233MR	D2HW-C233MR
Left-side		SPST-NC	D2HW-BL232ML	D2HW-EL232ML	-	
		SPST-NO	D2HW-BL233ML	D2HW-EL233ML	-	
Hinge roller lever 		Solder	Molded lead wires	SPDT	D2HW-BL241H	D2HW-EL241H
	SPDT			D2HW-BL241M	D2HW-EL241M	D2HW-C241M
	Downwards	SPST-NC		D2HW-BL242M	D2HW-EL242M	D2HW-C242M
		SPST-NO		D2HW-BL243M	D2HW-EL243M	D2HW-C243M
	Right-side	SPST-NC		D2HW-BL242MR	D2HW-EL242MR	D2HW-C242MR
		SPST-NO		D2HW-BL243MR	D2HW-EL243MR	D2HW-C243MR
	Left-side	SPST-NC	D2HW-BL242ML	D2HW-EL242ML	-	
		SPST-NO	D2HW-BL243ML	D2HW-EL243ML	-	
	Straight leaf lever 	Solder	Molded lead wires	SPDT	D2HW-BL251H	D2HW-EL251H
SPDT				D2HW-BL251M	D2HW-EL251M	D2HW-C251M
Downwards		SPST-NC		D2HW-BL252M	D2HW-EL252M	D2HW-C252M
		SPST-NO		D2HW-BL253M	D2HW-EL253M	D2HW-C253M
Right-side		SPST-NC		D2HW-BL252MR	D2HW-EL252MR	D2HW-C252MR
		SPST-NO		D2HW-BL253MR	D2HW-EL253MR	D2HW-C253MR
Left-side		SPST-NC	D2HW-BL252ML	D2HW-EL252ML	-	
		SPST-NO	D2HW-BL253ML	D2HW-EL253ML	-	
Leaf lever 		Solder	Molded lead wires	SPDT	D2HW-BL261H	D2HW-EL261H
	SPDT			D2HW-BL261M	D2HW-EL261M	D2HW-C261M
	Downwards	SPST-NC		D2HW-BL262M	D2HW-EL262M	D2HW-C262M
		SPST-NO		D2HW-BL263M	D2HW-EL263M	D2HW-C263M
	Right-side	SPST-NC		D2HW-BL262MR	D2HW-EL262MR	D2HW-C262MR
		SPST-NO		D2HW-BL263MR	D2HW-EL263MR	D2HW-C263MR
	Left-side	SPST-NC	D2HW-BL262ML	D2HW-EL262ML	-	
		SPST-NO	D2HW-BL263ML	D2HW-EL263ML	-	
	Simulated roller leaf lever 	Solder	Molded lead wires	SPDT	D2HW-BL271H	D2HW-EL271H
SPDT				D2HW-BL271M	D2HW-EL271M	D2HW-C271M
Downwards		SPST-NC		D2HW-BL272M	D2HW-EL272M	D2HW-C272M
		SPST-NO		D2HW-BL273M	D2HW-EL273M	D2HW-C273M
Right-side		SPST-NC		D2HW-BL272MR	D2HW-EL272MR	D2HW-C272MR
		SPST-NO		D2HW-BL273MR	D2HW-EL273MR	D2HW-C273MR
Left-side		SPST-NC	D2HW-BL272ML	D2HW-EL272ML	-	
		SPST-NO	D2HW-BL273ML	D2HW-EL273ML	-	
Long leaf lever 		Solder	Molded lead wires	SPDT	D2HW-BL281H	D2HW-EL281H
	SPDT			D2HW-BL281M	D2HW-EL281M	D2HW-C281M
	Downwards	SPST-NC		D2HW-BL282M	D2HW-EL282M	D2HW-C282M
		SPST-NO		D2HW-BL283M	D2HW-EL283M	D2HW-C283M
	Right-side	SPST-NC		D2HW-BL282MR	D2HW-EL282MR	D2HW-C282MR
		SPST-NO		D2HW-BL283MR	D2HW-EL283MR	D2HW-C283MR
	Left-side	SPST-NC	D2HW-BL282ML	D2HW-EL282ML	-	
		SPST-NO	D2HW-BL283ML	D2HW-EL283ML	-	

Note1. The length of standard lead wires (AVSS 0.5) for molded lead wire models shown above is 30 cm.

Note2. "S" is added to the end of the model number for the UL/CSA-approved version. The lead wire models are UL approved wires (AWG24, UL1007).

Consult your OMRON sales representative for details.

Contact form

● SPDT

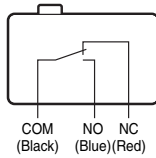

● SPST-NC, (Molded Lead Wire Models Only)

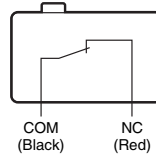

● SPST-NO, (Molded Lead Wire Models Only)

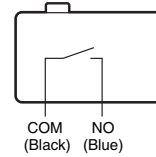

Molded lead wire colors are indicated in parentheses.

Contact Specifications

Contact	Specification	Crossbar
	Material	Gold alloy
	Gap (standard value)	0.5 mm
Minimum applicable load (see note)		5 VDC 1mA

Ratings

Rated voltage	Resistive load
125 VAC	0.1A
12 VDC	2A
24 VDC	1A
42 VDC	0.5A

Note. The above rating values apply under the following test conditions.

- (1) Ambient temperature: 20±2°C
- (2) Ambient humidity: 65±5 %
- (3) Operating frequency: 30 operations/min

Approved Safety Standard

Consult your OMRON sales representative for specific models with standard approvals.

UL (UL1054/CSA C22.2 No.55)

Rated voltage	Model	D2HW
	Item	Resistive load
125 VAC		0.1A
12 VDC		2A
24 VDC		1A
42 VDC		0.5A

Characteristics

Permissible operating speed	1 mm to 500 mm/s (for pin plunger models)	
Permissible operating frequency	30 operations/min	
Insulation resistance	100 MΩ min. (at 500 VDC with insulation tester)	
Contact resistance (initial value)	Terminals	100 mΩ max.
	Molded lead wire models	150 mΩ max.
Dielectric strength	Between terminals of the same polarity	600 VAC 50/60 Hz 1min
	Between current-carrying metal parts and ground	1,500 VAC 50/60 Hz 1 min
	Between terminals and non-current-carrying metal parts	1,500 VAC 50/60 Hz 1 min
Vibration resistance * 1	Malfunction	10 to 55 Hz, 1.5 mm double amplitude
Shock resistance	Durability	1,000 m/s ² {approx. 100G} max.
	Malfunction * 1	300 m/s ² {approx. 30G} max.
Durability * 2	Mechanical	1,000,000 operations min. (30 operations/min)
	Electrical	100,000 operations min. (20 operations/min)
Degree of protection	Terminals	IEC IP67 (excluding the terminals on terminal models)
	molded lead wire models	IEC IP67
Ambient operating temperature	-40 to +85°C (at ambient humidity of 60% max.) (with no icing or condensation)	
Ambient operating humidity	95% max. (for +5 to +35°C)	
Weight	Approx. 0.7 g (for pin plunger models with terminals)	

Note. The data given above are initial values.

*1. For the pin plunger models, the above values apply for use at the free position, operating position, and total travel position. For the lever models, they apply at the total travel position. Close or open circuit of the contact is 1ms max.

*2. For testing conditions, consult your OMRON sales representative.

Mounting Structure and Reference Positions for Operating Characteristics (Unit: mm)

●Without posts
D2HW-A□

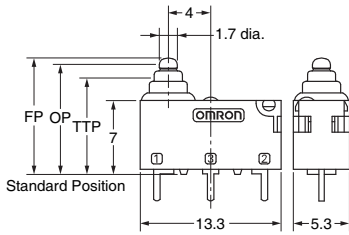

●Long post
D2HW-B□

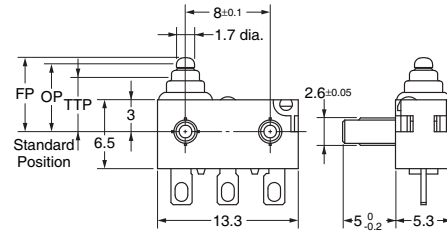

●M3-screw Mounting Models
D2HW-C□

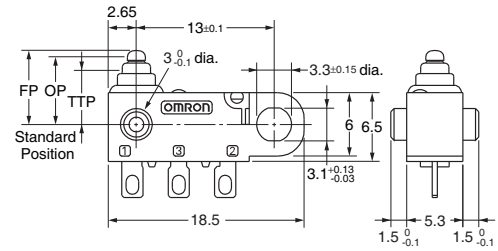

Mounting Hole Dimensions (Reference)

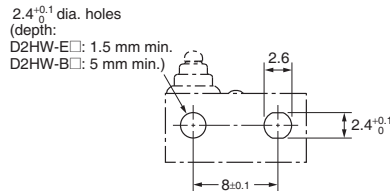

Mounting Hole Dimensions (Reference)

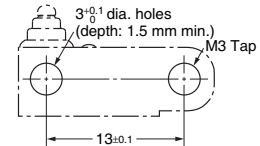

●Short post
D2HW-E□

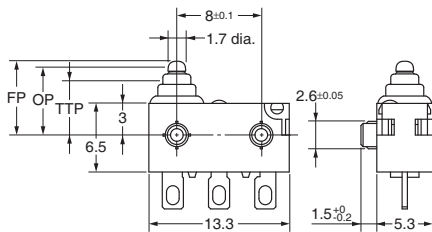

Note. The reference positions used for Free Position (FP), Operating Position (OP), and Total Travel Position (TTP) values are as shown above for each type of mounting.

Terminals/Apearances (Unit: mm)

●PCB terminals (Straight)

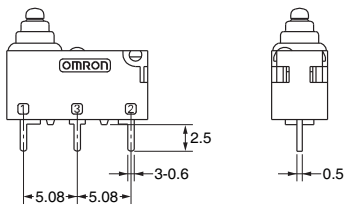

<PCB Mounting Dimensions (Reference)>

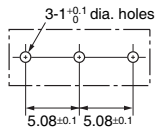

●PCB Terminals (Left-angled)

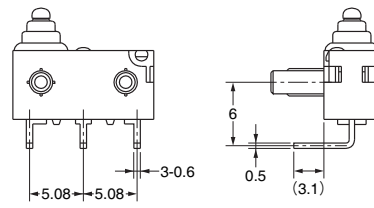

<PCB Cutout Dimensions (Reference)>

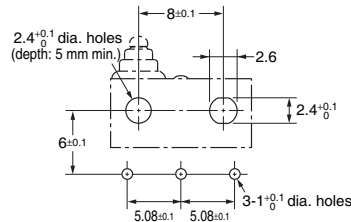

●PCB terminals (Right-angled)

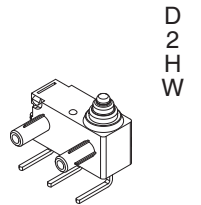
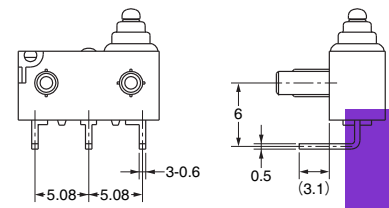

D
2
H
W

●Solder terminals

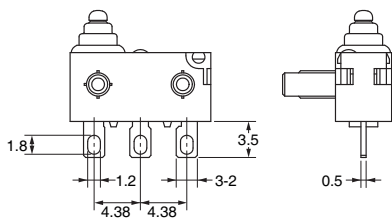

●Molded Lead Wires on Left-side

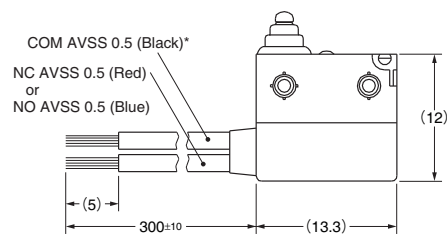

* UL approved wires (AWG24, UL1007) are used for UL/CSA standard approved items.

●Molded Lead Wires on Right-side

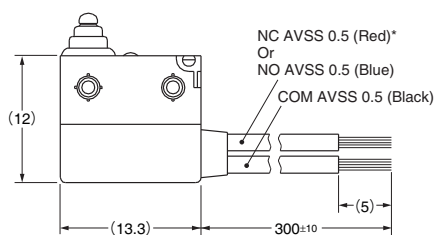

* UL approved wires (AWG24, UL1007) are used for UL/CSA standard approved items.

●Molded Lead Wires Downwards

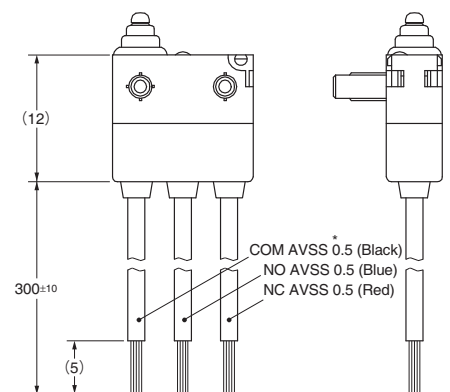

* UL approved wires (AWG24, UL1007) are used for UL/CSA standard approved items.

Dimensions (Unit: mm) / Operating Characteristics

The following illustrations and drawings are representative models. When ordering, replace □ with the code for the mounting structure, contact form and terminal that you need.
See the "List of Models" for available combinations of appearances.
Refer to page 3 to 4 for the mounting structures and terminal forms.

● Pin plunger

D2HW-□20□□

D
2
H
W

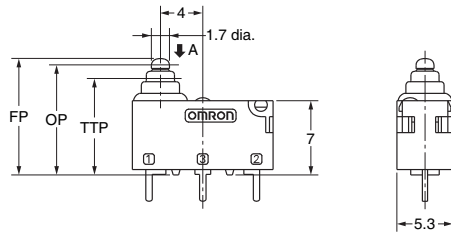

Operating characteristics	Type	Without posts	Models with Posts	M3-screw Mounting Models
Operating Force	OF Max.	0.75N {76 gf}		
Releasing Force	RF Min.	0.10N {10 gf}		
Overtravel	OT	1.4 mm (reference value)		
Movement Differential	MD Max.	0.25 mm		
Free Position	FP Max.	11.2 mm	7.2 mm	
Operating Position	OP	10.4±0.2 mm	6.4±0.2 mm	
Total Travel Position	TTP Max.	9.1 mm	5.1 mm	

● Hinge Lever

D2HW-□21□□

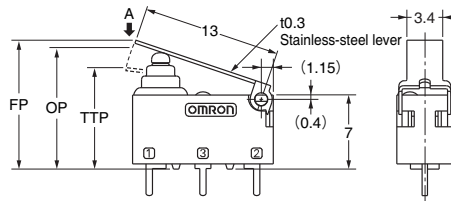

Operating characteristics	Type	Without posts	Models with Posts	M3-screw Mounting Models
Operating Force	OF Max.	0.75N {76 gf}		
Releasing Force	RF Min.	0.07N {7 gf}		
Overtravel	OT	1.6 mm (reference value)		
Movement Differential	MD Max.	0.5 mm		
Free Position	FP Max.	12.8 mm	8.8 mm	
Operating Position	OP	11.5±0.5 mm	7.5±0.5 mm	
Total Travel Position	TTP Max.	10 mm	6 mm	

● Long Hinge Lever

D2HW-□22□□

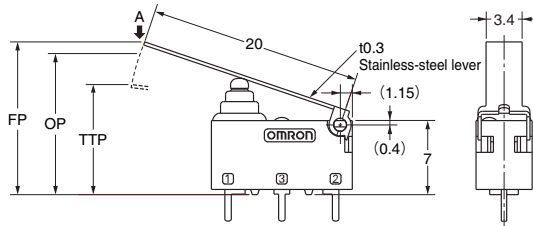

Operating characteristics	Type	Without posts	Models with Posts	M3-screw Mounting Models
Operating Force	OF Max.	0.5N {50 gf}		
Releasing Force	RF Min.	0.03N {3 gf}		
Overtravel	OT	2.5 mm (reference value)		
Movement Differential	MD Max.	0.8 mm		
Free Position	FP Max.	15.5 mm	11.5 mm	
Operating Position	OP	13.3±0.8 mm	9.3±0.8 mm	
Total Travel Position	TTP Max.	11 mm	7 mm	

● Simulated Roller Lever

D2HW-□23□□

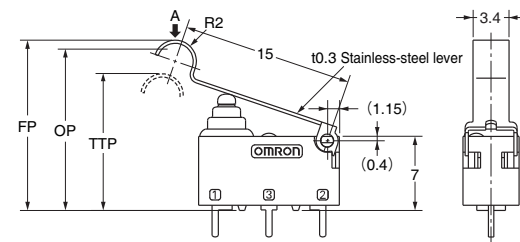

Operating characteristics	Type	Without posts	Models with Posts	M3-screw Mounting Models
Operating Force	OF Max.	0.65N {66 gf}		
Releasing Force	RF Min.	0.05N {5 gf}		
Overtravel	OT	1.9 mm (reference value)		
Movement Differential	MD Max.	0.5 mm		
Free Position	FP Max.	16.5 mm	12.5 mm	
Operating Position	OP	15.2±0.5 mm	11.2±0.5 mm	
Total Travel Position	TTP Max.	13.5 mm	9.5 mm	

● Hinge Roller Lever

D2HW-□24□□

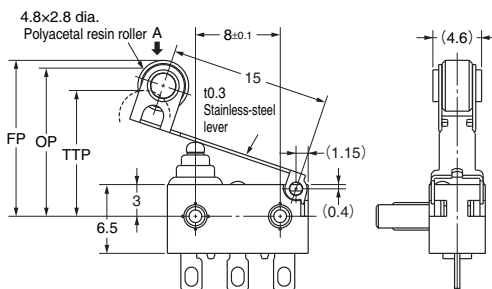

Operating characteristics	Type	Without posts	Models with Posts	M3-screw Mounting Models
Operating Force	OF Max.	0.65N {66 gf}		
Releasing Force	RF Min.	0.03N {3 gf}		
Overtravel	OT	1.9 mm (reference value)		
Movement Differential	MD Max.	0.6 mm		
Free Position	FP Max.	15.3 mm		
Operating Position	OP	14±0.6 mm		
Total Travel Position	TTP Max.	12.3 mm		

Note1. Unless otherwise specified, a tolerance of ±0.2mm applies to all dimensions.
Note2. The operating characteristics are for operation in the A direction (↓).

●Leaf straight lever

D2HW-□25□□

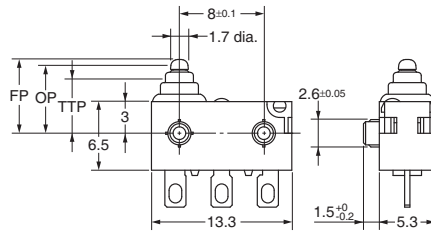
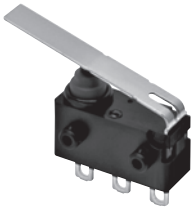

Operating characteristics	Type	Models with Posts	M3-screw Mounting Models
Operating Force	OF Max.	1.2N {122 gf}	
Releasing Force	RF Min.	0.05N {5 gf}	
Overtravel	OT	2.5 mm (reference value)	
Movement Differential	MD Max.	0.7 mm	
Free Position	FP Max.	11.9 mm	
Operating Position	OP	8.1±0.8 mm	
Total Travel Position	TTP Max.	6.0 mm	

●Leaf Lever

D2HW-□26□□

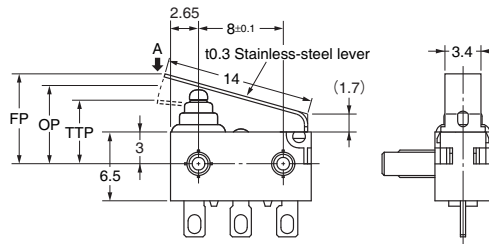

Operating characteristics	Type	Models with Posts	M3-screw Mounting Models
Operating Force	OF Max.	1.8N {183 gf}	
Releasing Force	RF Min.	0.20N {20 gf}	
Overtravel	OT	1.8 mm (reference value)	
Movement Differential	MD Max.	0.5 mm	
Free Position	FP Max.	9.3 mm	
Operating Position	OP	7.4±0.5 mm	
Total Travel Position	TTP Max.	5.8 mm	

●Simulated Roller Lever

D2HW-□27□□

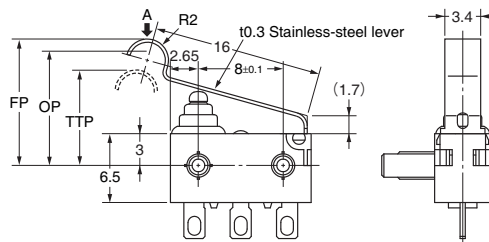

Operating characteristics	Type	Models with Posts	M3-screw Mounting Models
Operating Force	OF Max.	1.8N {183 gf}	
Releasing Force	RF Min.	0.20N {20 gf}	
Overtravel	OT	2.0 mm (reference value)	
Movement Differential	MD Max.	0.5 mm	
Free Position	FP Max.	13.0 mm	
Operating Position	OP	10.8±0.5 mm	
Total Travel Position	TTP Max.	8.9 mm	

●Long Leaf Lever

D2HW-□28□□

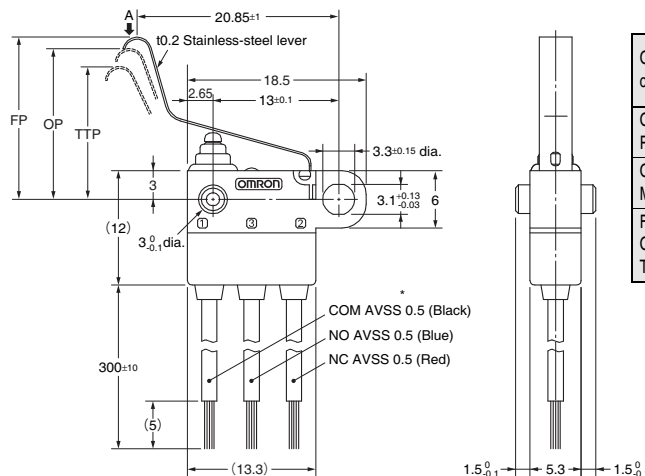

Operating characteristics	Type	Models with Posts	M3-screw Mounting Models
Operating Force	OF Max.	0.9N {92 gf}	
Releasing Force	RF Min.	0.05N {5 gf}	
Overtravel	OT	2.8 mm (reference value)	
Movement Differential	MD Max.	0.7 mm	
Free Position	FP Max.	19 mm	
Operating Position	OP	15.4±1.5 mm	
Total Travel Position	TTP Max.	12.8 mm	

* UL approved wires (AWG24, UL1007) are used for UL/CSA standard approved items.

Note1. Unless otherwise specified, a tolerance of ±0.2mm applies to all dimensions.

Note2. The operating characteristics are for operation in the A direction (↓).

Precautions

★Please refer to "General Information" for correct use.

Cautions

●Degree of Protection

- Do not use this product underwater. Although molded lead wire models satisfy the test conditions for the standard given below, this test is to check the ingress of water into the switch enclosure after submerging the Switch in water for a given time. Satisfying this test condition does not mean that the Switch can be used underwater.
 - JIS C0920:
Degrees of protection provided by enclosures of electrical apparatus (IP Code)
 - IEC 60529:
Degrees of protection provided by enclosures (IP Code)
 - Degree of protection: IP67
(check water intrusion after immersion for 30 min. submerged 1m underwater)
- Do not operate the Switch when it is exposed to water spray, or when water drops adhere to the Switch surface, or during sudden temperature changes, otherwise water may intrude into the interior of the Switch due to a suction effect.
- Prevent the Switch from coming into contact with oil and chemicals. Otherwise, damage to or deterioration of Switch materials may result.
- Do not use the Switch in areas where it is exposed to silicon adhesives, oil, or grease. Otherwise faulty contact may result due to the generation of silicon oxide.

●Soldering

When soldering the lead wire to the terminal, first insert the lead wire conductor through the terminal hole and then conduct soldering. Make sure that the temperature of the soldering iron tip does not exceed 300°C, and complete the soldering within 3 seconds. Do not apply any external force for 1 minute after soldering. Soldering at an excessively high temperature or soldering for more than 3 seconds may deteriorate the characteristics of the Switch. In case of automatic soldering, please do not apply the heat beyond 260°C within 5 seconds. Pay careful attention so that flux or solder liquid does not flow over the edge of the PCB panel.

●Side-actuated (Cam/Dog) Operation

- When using a cam or dog to operate the Switch, factors such as the operating speed, operating frequency, push-button indentation, and material and shape of the cam or dog will affect the durability of the Switch. Confirm performance specifications under actual operating conditions before using the Switch in applications.

Correct Use

●Mounting

- Turn OFF the power supply before mounting or removing the Switch, wiring, or performing maintenance or inspection. Failure to do so may result in electric shock or burning.
- For M3-screw mounting models, use M3 mounting screws with plane washers or spring washers to securely mount the Switch. Tighten the screws to a torque of 0.27 to 0.29 N·m {27.5 to 29.5 gf}. Exceeding the specified torque may result in deterioration of the sealing or damage.
- For models with posts, secure the posts by thermal caulking or by pressing into an attached device. When pressed into an attached device, provide guides on the opposite ends of the posts to ensure that they do not fall out or rattle. Thermal caulking conditions varies according to the equipment, jig and base used for switch mounting. Consult your OMRON sales representative for details.

●Operating Body

- Use an operating body with low frictional resistance and of a shape that will not interfere with the sealing rubber, otherwise the plunger may be damaged or the sealing may deteriorate.

●Handling

- Do not handle the Switch in a way that may cause damage to the sealing rubber.
- When handling the Switch, ensure that pressure is not applied to the posts in the directions shown in the following diagram. Also, ensure that uneven pressure or pressure in a direction other than the operating direction is not applied to the Actuator as shown in the following diagram. Otherwise, the post, Actuator, or Switch may be damaged, or the service life may be reduced.

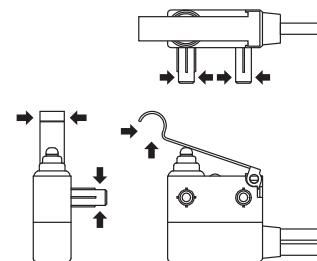

●Wiring Molded Lead Wire Models

- When wiring molded lead wire models, ensure that there is no weight applied on the wire or that there are no sharp bends near the parts where the wire is drawn out. Otherwise, damage to the Switch or deterioration in the sealing may result.

●Using Micro Loads

- Even when using micro load models within the operating range shown below, if inrush/surge current occurs, it may increase the contact wear and so decrease durability. Therefore, insert a contact protection circuit where necessary.

- Application examples provided in this document are for reference only. In actual applications, confirm equipment functions and safety before using the product.
- Consult your OMRON representative before using the product under conditions which are not described in the manual or applying the product to nuclear control systems, railroad systems, aviation systems, vehicles, combustion systems, medical equipment, amusement machines, safety equipment, and other systems or equipment that may have a serious influence on lives and property if used improperly. Make sure that the ratings and performance characteristics of the product provide a margin of safety for the system or equipment, and be sure to provide the system or equipment with double safety mechanisms.

Note: Do not use this document to operate the Unit.