

Energy saving, High brightness,  
High accuracy UV irradiation using LED type  
Complete range of Lamp type, too.

For resin curing in adhesion, printing, separation, coating, as a UV light source for inspection,  
and for other uses, for workpieces and applications, choose from our lineup.

## UJ30 / UJ35

LED  
UV Curing System



## UD40 series

LED  
UV Curing System



## UP50

LAMP  
UV Curing System



## ANUP8000 series

LAMP  
UV Curing System

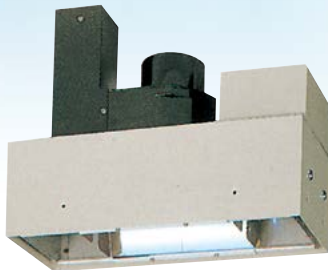

## UD90 series

LED  
UV Curing System









## ANUP7000 series

LAMP  
UV Curing System



The energy-efficient and high-precision UV irradiation systems come in the LED and lamp types to meet diverse requirements for a variety of workpieces.

# Lineup

		Series	UV intensity	Advantages	Disadvantages
LED Type	Spot Type	 <b>UJ35</b>	<b>UJ30 / UJ35</b> with 22,000 mW/cm <sup>2</sup>	<ul style="list-style-type: none"> <li>Low thermal stress</li> <li>Capable of irradiation ON / OFF control</li> <li>Low power consumption</li> <li>Stable UV irradiation</li> </ul>	<ul style="list-style-type: none"> <li>Requires UV resin that cures at a single wavelength 365 nm, 385 nm or 405 nm (405 nm type is available for combining with <b>UJ30 / UJ35</b> only)</li> </ul>
	Line Type		<b>UD40 series</b> with 4,600 mW/cm <sup>2</sup>	<ul style="list-style-type: none"> <li>Long estimated light source life</li> <li>Small size</li> <li>Does not generate ozone</li> <li>Exhaust duct not required</li> </ul>	
	Line Type		<b>UD90 series</b> with 10,000 mW/cm <sup>2</sup>	<ul style="list-style-type: none"> <li>Can be used with large equipment</li> <li>Suitable for UV irradiation through polycarbonate (<b>UJ30 / UJ35</b> 405 nm type)</li> </ul>	
Lamp Type	Spot Type		<b>UP50</b> with 6,000 mW/cm <sup>2</sup>		
	Tube Type		<b>ANUP8000 series</b> 1.5 kW (Note) 3 kW (Note) 6 kW (Note)	<ul style="list-style-type: none"> <li>Broad UV wavelength range (including heat rays)</li> </ul>	<ul style="list-style-type: none"> <li>High thermal stress</li> <li>Short lamp life</li> </ul>
			<b>ANUP7000 series</b> 3 kW (Note) 6 kW (Note)	<ul style="list-style-type: none"> <li>Compatible with a variety of UV resins</li> </ul>	<ul style="list-style-type: none"> <li>Exhaust duct required (tube type)</li> </ul>
			<b>ANUP3000 series</b> 1.5 kW (Note) 3 kW (Note)		

Note: For the tube type, the lamp output is indicated.

Applications

Bonding and curing applications



Assembly of lens modules



Fixing and bonding of camera modules

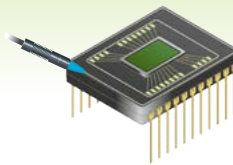

Adhesion of image sensor glass

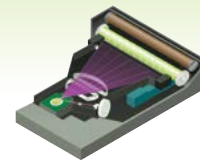

Optical parts for printers and copiers

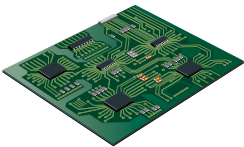

Resin coatings for printed circuit boards



Adhesion of vehicle coil terminals

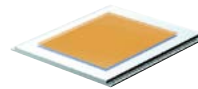

Sealing of LCDs and organic ELs

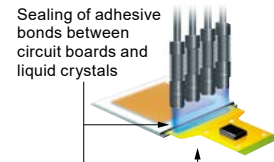

Reinforcement of UV resin at flexible board junctions

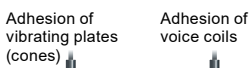

Adhesion of voice coils

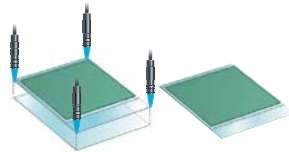

Temporary adhesion and permanent curing of touch panels

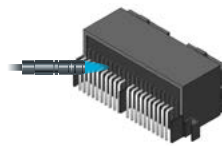

Reinforcement and waterproofing of vehicle-use connectors



Adhesion of touch panels and printed circuit boards

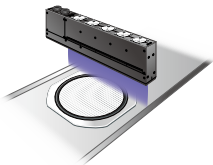

Curing and separation of dicing film and BG film



Adhesion of injection needles and medical devices

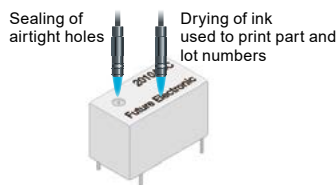

Curing of ink used to print text on electronic components

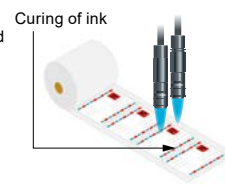

Curing of ink used to print labels

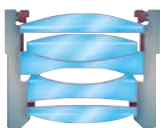

Manufacture of hybrid lenses



Hard coating for cases and all kinds of ornaments

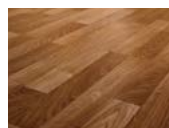

Construction material and flooring coatings

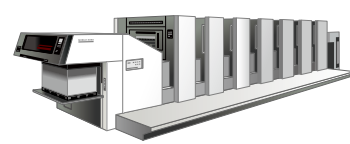

UV printing UV ink jet printing

UV light sources for testing use



Luminescence testing of fluorescent substances



Testing for the presence of oil, grease, and other materials containing fluorescent substances

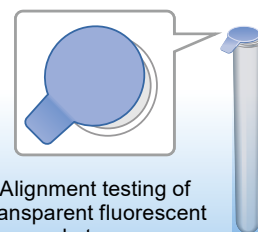

Alignment testing of transparent fluorescent substances

# Featuring Panasonic high-efficiency lens \*1 High-output Head equivalent to 20,000 mW/cm<sup>2</sup> class \*2

\*1 Lens embedded in the head of ANUJ6186, ANUJ6188 or ANUJ6189.

\*2 Peak value and representative value at an irradiation distance of 8 mm (0.315 in) when ANUJ6186 or ANUJ6423 is used.

## High-output head equipped with new high-efficiency lens

Wavelength 365 nm **ANUJ6186** Wavelength 405 nm **ANUJ6189**  
Wavelength 385 nm **ANUJ6188**



## Standard type head inherits an existing intensity profile

Wavelength 365 nm **ANUJ6180** Wavelength 405 nm **ANUJ6187**  
Wavelength 385 nm **ANUJ6184**

### UV intensity comparison with existing models

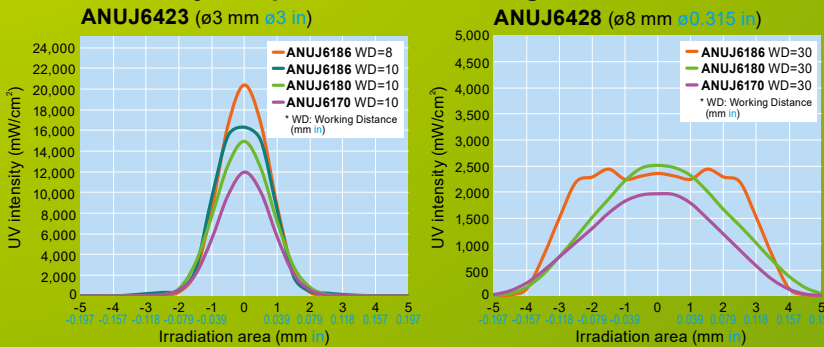

The intensity profiles shown are representative values, not guaranteed values. Install the metal attachment (ANUJ6804), or take other heat radiation measures.

- Advantage 1** Tact time can be significantly reduced.
- Advantage 2** If the same UV intensity as the existing head model is required, output can be reduced, which will save power and extend LED life.
- Advantage 3** The UV irradiation area can be significantly expanded.
- Advantage 4** 405 nm type Extend UV curing to coatings that were hard to irradiate. Now, you can even perform photo-curing of adhesion through glass or resin.

# High-performance of High-output head brings real benefit! User-friendliness and Stable Irradiation

## Controller selections for you applications UJ30 / UJ35

Controller selection for you applications	<b>Standard model</b> <b>UJ30</b> Limited to most necessary and sufficient functions provides highly reliable UV irradiation.		<b>High performance model</b> <b>UJ35</b> A variety of functions will provide more advanced UV irradiation solution.	
	User-friendly	Easy-to-read display and easy-to-operate panel are as simple to use as a home appliance.		
Stable irradiation	The LED head incorporates a temperature sensor. The temperature feedback control provides excellent irradiation stability.			
Four-head irradiation	Different irradiation power and time can be set for each LED head attached to the controller. Both "all" and "individual" UV irradiation modes are available.			
External control	UV irradiation operation can be externally controlled using the parallel I/O, enabling automatic control suitable for production lines.		UV irradiation operation can be externally controlled using the parallel I/O or the RS232C port, enabling automatic control suitable for production lines.	
UV sensor	—	UV intensity measurement and automatic calibration can be done at the actual production line using the slim UV sensor.		
Programmable irradiation	—	The programmable irradiation function helps prevents curing distortion and enable high-quality precision bonding at a lower temperature.		
Multiple setting profiles	—	Up to 8 different irradiation patterns can be saved.		
UJ35 software (Note)	—	Free downloadable software available from our website for easy PC operation. Software will allow you to operate the unit from a PC. Also allows you to save irradiation programs. Japanese, English, Chinese and Korean languages available.		
Global 3-year warranty	Guaranteed for three years from date of purchase (controller only) For details, please visit our website. <a href="http://industrial.panasonic.com/ac/e/fasys/warranty/index.jsp">http://industrial.panasonic.com/ac/e/fasys/warranty/index.jsp</a>			

Quick setup immediately after installation

# User Friendly Interface



## Simple interface

Easy-to-read display and easy-to-operate panel

UJ30 / UJ35 can be easily set up like setting up a home appliance. Only three switches required for basic settings.

- 1 Choose LED head (CH1 to CH4).
- 2 Set UV irradiation intensity (%).
- 3 Set irradiation time.

(0.0 sec. to 999 sec., continuous irradiation: [Con])  
To set [Con], press "▼" once again at 0.0 sec. or press "▲" once again at 999 sec.

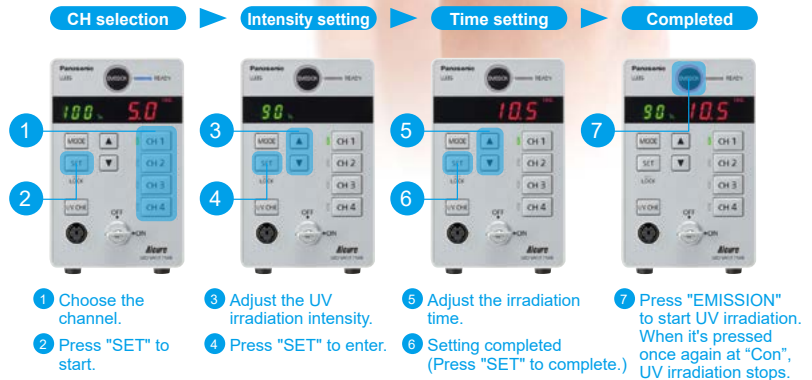

## Four individually controllable LED heads

The irradiation power and time can be individually controlled.

The irradiation power, time, and timing of the LED heads can be individually controlled. With the lamp type model, one process requires one irradiation unit. With UJ30 / UJ35, one unit can be used for up to four processes due to its four individually-controllable LED heads. It will also show a notice if any of the LED head reaches time to replace or when there is a temperature warning on one of the heads.



## External control

UV irradiation can be controlled by external signal inputs, enabling automatic control in production lines.

UV irradiation (time and irradiation timing) of the LED heads can be controlled by parallel signals from a programmable controller or other external devices.

A variety of control is possible. For example, UV irradiation time can be set up in increments of 0.1 seconds by the controller for each LED head. And an external signals can be used to individually start or stop the UV irradiation of the LED heads. With UJ35, irradiation control using RS232C (Note 1) is available.

"UJ35 software (free) (Note 2)," the setup process can be easily set up using a PC.

Notes: 1) Use straight RS232C for connection to PC or similar. Cable side: D-sub connector 9-pin (female pin)  
2) Downloadable from our website.  
[http://industrial.panasonic.com/ac/e/fasys/software\\_info/uv/tol\\_uj30-uj35.jsp](http://industrial.panasonic.com/ac/e/fasys/software_info/uv/tol_uj30-uj35.jsp)

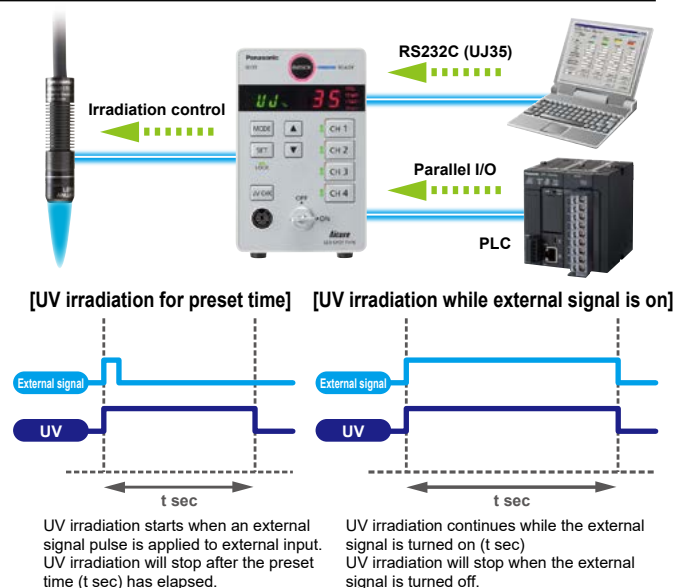

# Strict quality control

# Stable Irradiation

## Prevention of resin curing defects and bonding failures

### Temperature feedback control

Panasonic's original

±3 % or better UV irradiation accuracy (for wavelength 365 nm / 385 nm type with the intensity set to 80 %)

Generally, when the LED temperature rises, the UV irradiation output decreases. To prevent the temperature to rise, the LED heads are built with metal materials with fins to increase heat dissipation. The LED heads are also equipped with a built-in temperature sensor to feedback the temperature to the controller. The controller will calculate the loss of power due to temperature increase, enabling stable UV irradiation at an accuracy within ±3 % when the intensity is set to 80 %. This high performance is ideal for high-quality and precision bonding applications.

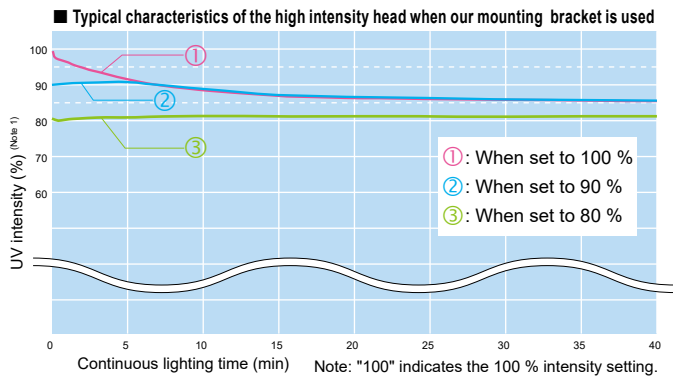

## Infrared rays-free UV irradiation

### High-accuracy bonding without thermal distortion

The LED heads irradiate 365 nm, 385 nm wavelength UV rays or 405 nm short wavelength, which do not contain infrared rays (heat) unlike the light from the lamp type system, preventing the temperature rise of workpieces. This is ideal for applications that require high precision bonding with minimum thermal distortion, such as the assembly of thin plastic lenses.

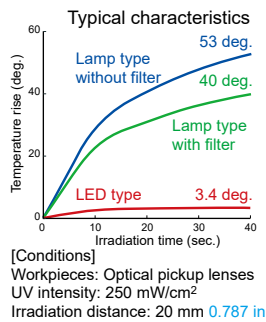

### LED emission spectrum

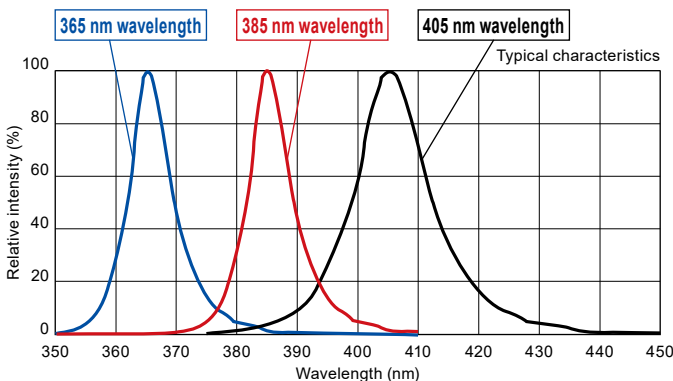

## Programmable irradiation function (for UJ35)

This function prevents curing distortion and enables high-quality precision bonding.

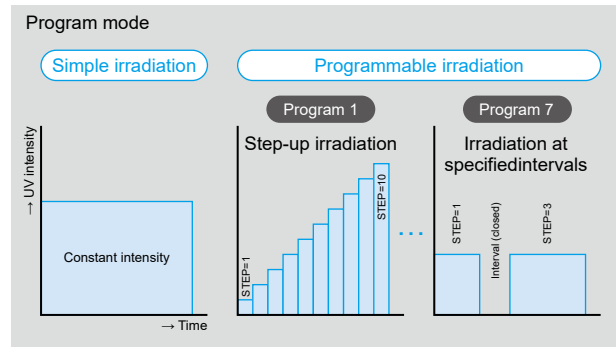

The irradiation can be programmed to controls the irradiation power and time depending on the resin and curing application, supporting high-quality and high-precision bonding with minimum cure shrinkage. In addition to the simple irradiation mode which irradiation is continuously performed at a constant intensity, up to 10 steps 7 different irradiation patterns (7 product types) can be programmed for each of the four LED head.

## Significantly higher reliability for bonding and fixing

### Slim UV sensor (for UJ35)

Panasonic's original

The UV sensor for measuring irradiation intensity enables auto-turning in high-accuracy.

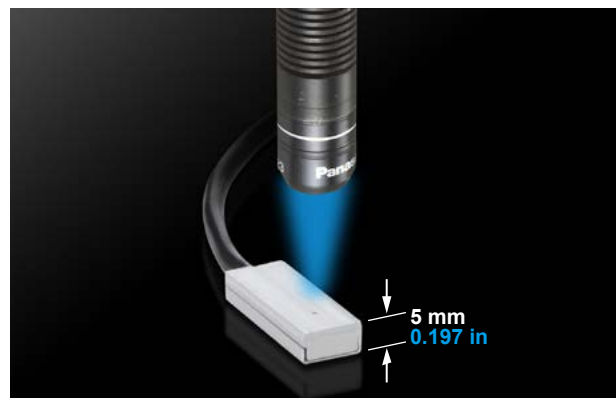

The UV irradiation intensity of the LED heads can be relative measured at the actual position by using the optional slim UV sensor (Note). It can also automatically adjust the UV intensity to the preset level. Since the sensor only has 5 mm 0.197 in thickness, which is similar to the workpiece, the intensity measurement is possible without removing the system from the production line, facilitating high-accuracy setting and in-line condition optimization. The UV intensity can be checked and adjusted at real time, enhancing the bonding and fixing reliability.

Note: UV intensity can be measured as a relative value.

Sensitivity adjustment of the UV sensor is carried out at 365 nm, if you use the UV sensor at 385 nm or 405 nm, the displayed value may be greater than the actual UV intensity.

For more information, please consult us.

Safe and reliable

# Environmental Consciousness and Reliable

Frequent part replacement is reduced by LED type.  
**Long-lasting cost effective LED type**

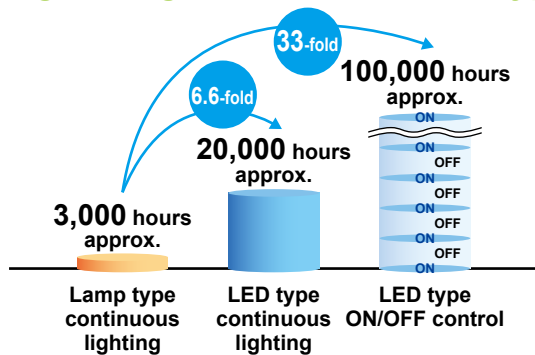

One of the biggest benefits of using the LED type is that the light source life is much longer than lamps used in lamp type. The life of the lamp is 3,000 hours approx., but the LED has 20,000 hours approx. Further more, unlike the lamp type, which needs to be kept turned on through out the operation, the LED type can turn on UV irradiation only when it is needed. When the irradiation ON/OFF time ratio is 1:4 (process cycle time = 5, irradiation time = 1), the LED type operation life is equivalent to 100,000 hours approx. compared to lamp types, leading to significant reductions in running costs and hours for maintenance.

You can see LED head temperature readings on the display!  
**Designed to dissipate heat, estimation of life is easy.**



While the display is showing irradiation conditions, you can see the temperature of the LED head simply by pressing the MODE button. The controller is designed to dissipate heat, and it is easy to estimation of life.

Estimated life according to LED temperature (The value is not a guaranteed value.)

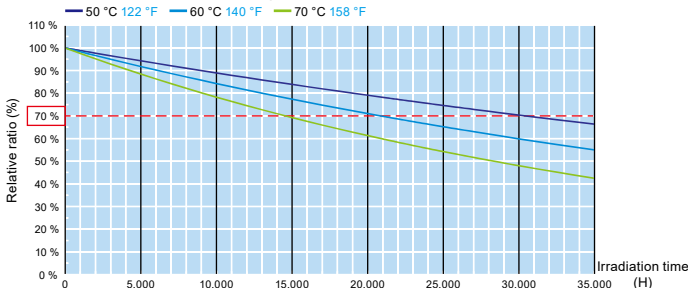

Reliable operation anywhere in the world  
**Covered by the global 3-year warranty**



Guaranteed for three years from the date of purchase (controller only), providing reliability even if the manufacturing line is at remote location. For details, please visit our website

<http://industrial.panasonic.com/ac/e/fasys/warranty/index.jsp>

Flexible cable for LED head will enable installation to even moving sections.

**Standard Flexible head cables**



Flexible cable has been adopted as the standard LED head connection cable considering that the LED heads will be mounted on to a moving section. Unlike silica fiber cables where there is a risk of damaging the cable by moving the cable too much, these flexible cables can be easily handled without risk of damaging. (withstanding 10 million bends to a radius of 33 mm 1.299 in based on our evaluation). The cables can be extended to a maximum of 10 m 32.808 ft using extension cables, which also have the same flexibility.

(The minimum allowable bend radius for 5 m 16.404 ft or longer cable diameter 5.5 mm 0.217 in is R45.6 mm R1.795 in.)

**Ideal for high-precision process. Helps reducing costs.**

**Cooling fan-less structure**

Without the need for a cooling fan, it is ideal for vibration-sensitive or dust-sensitive high precision process. Also, this design reduces need for exhaust ventilation ducting and related installation work as well as the running costs for exhaust ventilation and air conditioning.

**Lead and Mercury free**

**Eco product compliant with CE, RoHS, etc.**



Unlike lamps LED heads do not contain mercury. UJ30 and UJ35 conform to CE Marking, RoHS Directive, and Management Methods for Controlling Pollution by Electronic Information Products (China RoHS), ensuring environmentally safe use. (Please follow the proper industrial waste disposal procedures.)

**Available for worldwide use**

We have local sales companies to support the expansion of customers' global operations. Please visit our website to see our worldwide sales network.

<http://industrial.panasonic.com/ac/e/salesnetwork/index.jsp>



# Intensity Profiles (Typical example)

Featuring Panasonic high-efficiency lens (Note)

**High-output head** UV wavelength 365 nm (ANUJ6186)

Please see the Web site for intensity profiles data of UV wavelengths 385 nm (ANUJ6184, ANUJ6188) and 405 nm (ANUJ6187, ANUJ6189).

<http://industrial.panasonic.com/ac/e/fasys/uv/led/uj30-uj35/data/index.jsp>

Note: Lens embedded in the head of ANUJ6186, ANUJ6188 or ANUJ6189.

## Standard lens and Protective glass

\* WD: Working Distance (mm)

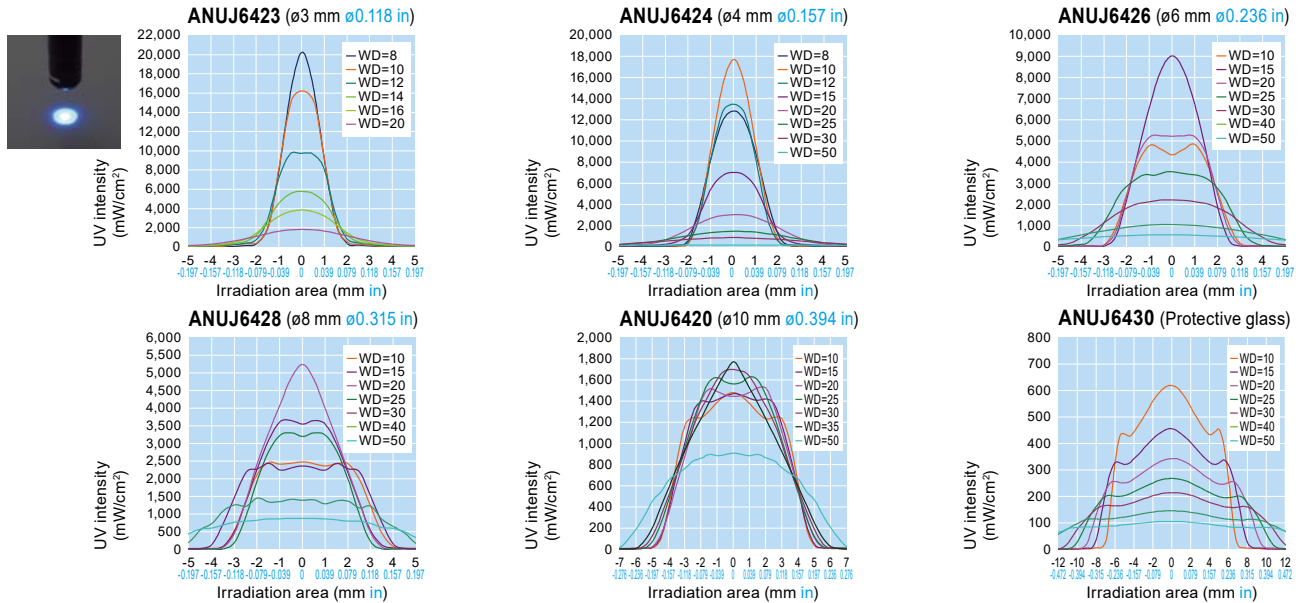

## Side view lens

\* WD: Working Distance (mm)

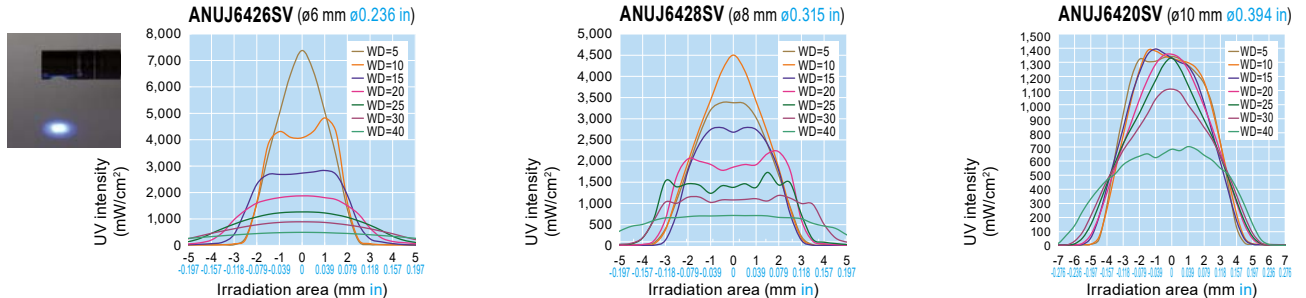

## Cylindrical lens

\* WD: Working Distance (mm)

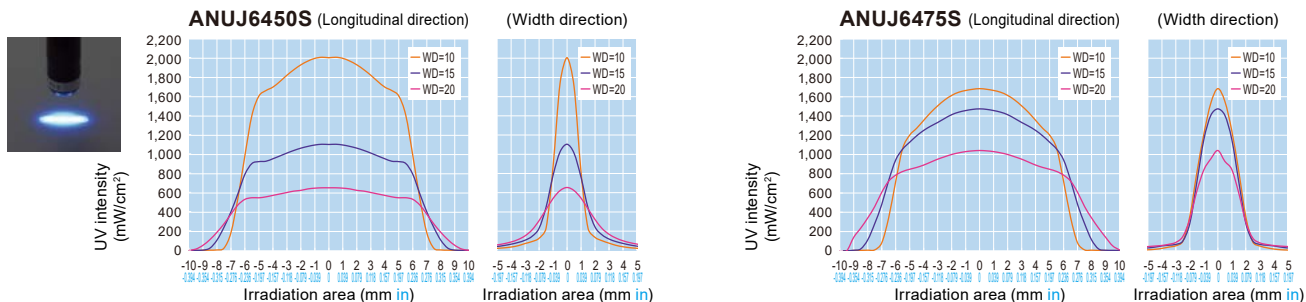

## Rod lens

\* WD: Working Distance (mm)

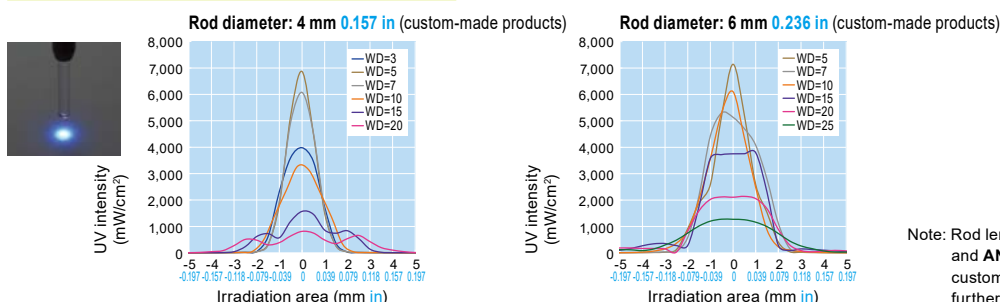

Note: Rod lens combined with ANUJ6186, ANUJ6188 and ANUJ6189 high-output heads are treated as custom-made products. Please consult us for further information.



# Inherits an existing intensity profile

## Standard type head UV wavelength 365 nm (ANUJ6180)

Please see the Web site for intensity profiles data of UV wavelengths 385 nm (ANUJ6184, ANUJ6188) and 405 nm (ANUJ6187, ANUJ6189).  
<http://industrial.panasonic.com/ac/e/fasys/uv/led/uj30-uj35/data/index.jsp>

### Standard lens and Protective glass

\* WD: Working Distance (mm)

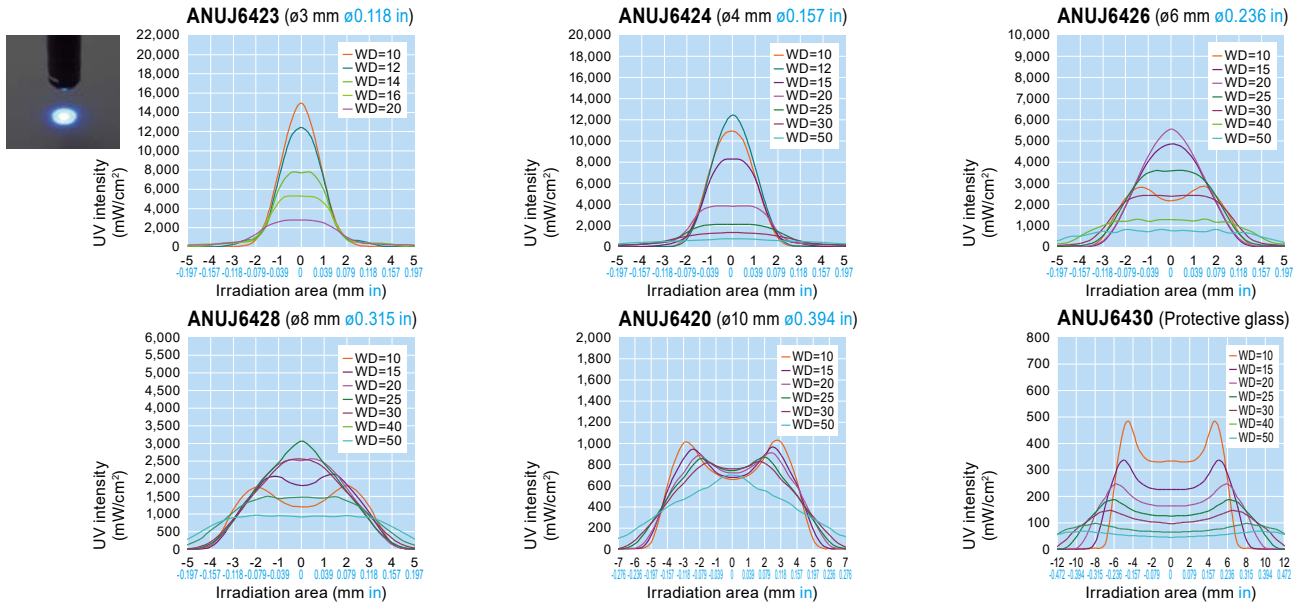

### Side view lens

\* WD: Working Distance (mm)

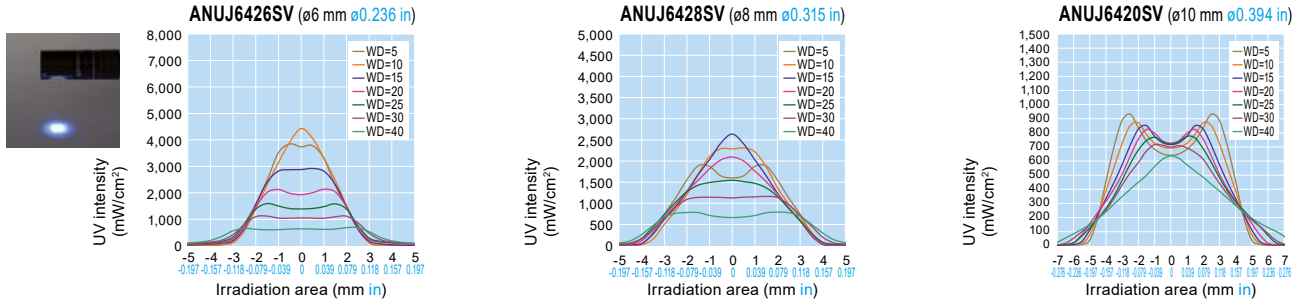

### Cylindrical lens

\* WD: Working Distance (mm)

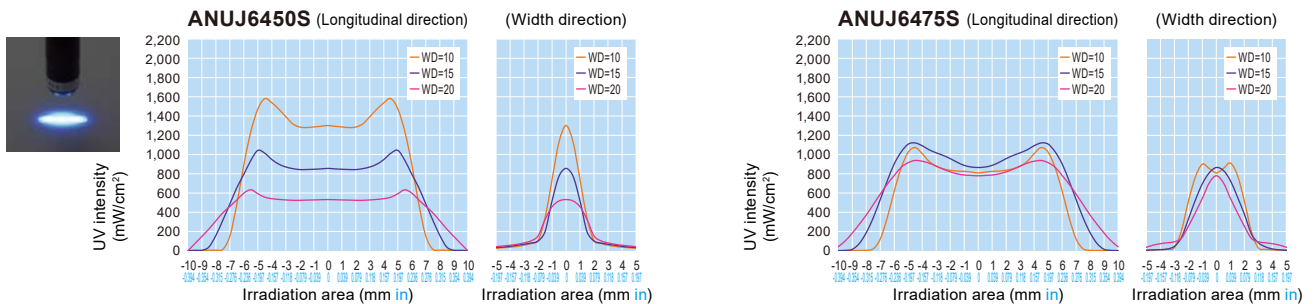

### Rod lens

\* WD: Working Distance (mm)

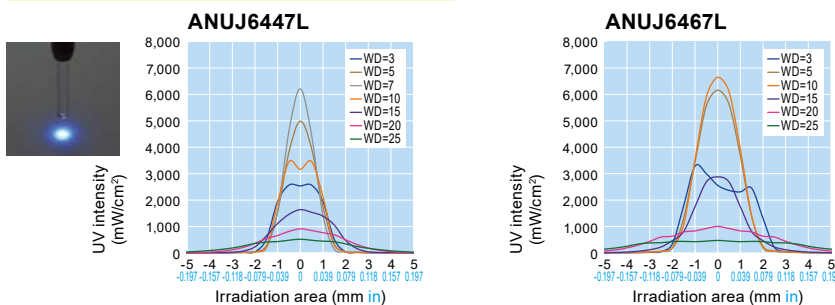

# Wide variation Product Lineup

**UJ30 controller  
ANUJ3000**



- Up to four heads can be connected.
- With an AC adapter (ANUJ6802)

**UJ35 controller  
ANUJ3500**



- Up to four heads can be connected.
- With an AC adapter (ANUJ6802)
- Compatible with a UV sensor (ANUJ3800)

**UV sensor  
ANUJ3800**



UV sensor for UJ35 / UP50 (includes 2 m 6.562 ft ANUJ38102 cable)

**UV sensor extension cable**  
**ANUJ38110** (10 m 32.808 ft)  
**ANUJ38102** (2 m 6.562 ft)









UV sensor connection cable (ANUJ38102 is the same cable that ships with the UV sensor)

**Connection cable  
ANUJ62\*\***



Cable length 1.7 m 5.906 ft (Cable diameter: ø 5.5 mm ø 0.217 in): ANUJ6220    Cable length 5 m 16.404 ft (Cable diameter: ø 7.6 mm ø 0.299 in): ANUJ6250    Cable length 10 m 32.808 ft (Cable diameter: ø 7.6 mm ø 0.299 in): ANUJ6200  
 Cable length 3 m 9.843 ft (Cable diameter: ø 5.5 mm ø 0.217 in): ANUJ6230    Cable length 7 m 22.966 ft (Cable diameter: ø 7.6 mm ø 0.299 in): ANUJ6270

(Note 1)  
Heads & Cables

High-output head 365 nm ANUJ6186	Standard type 365 nm ANUJ6180	High-output head 385 nm ANUJ6188	Standard type 385 nm ANUJ6184	High-output head 405 nm ANUJ6189	Standard type 405 nm ANUJ6187
					
• ø12 x 50 mm ø0.472 x 1.969 in • Cable length 0.2 m 0.656 ft	• ø12 x 50 mm ø0.472 x 1.969 in • Cable length 0.2 m 0.656 ft	• ø12 x 50 mm ø0.472 x 1.969 in • Cable length 0.2 m 0.656 ft	• ø12 x 50 mm ø0.472 x 1.969 in • Cable length 0.2 m 0.656 ft	• ø12 x 50 mm ø0.472 x 1.969 in • Cable length 0.2 m 0.656 ft	• ø12 x 50 mm ø0.472 x 1.969 in • Cable length 0.2 m 0.656 ft

**Standard lens  
ANUJ642\***



- Circular irradiation
- ø 3 mm 0.118 in: ANUJ6423
- ø 4 mm 0.157 in: ANUJ6424
- ø 6 mm 0.236 in: ANUJ6426
- ø 8 mm 0.315 in: ANUJ6428
- ø 10 mm 0.394 in: ANUJ6420

**Side view lens  
ANUJ642\*SV**



- Circular irradiation Angled at 9°
- ø 6 mm 0.236 in: ANUJ6426SV
- ø 8 mm 0.315 in: ANUJ6428SV
- ø 10 mm 0.394 in: ANUJ6420SV

**Cylindrical lens  
ANUJ64\*\*S**



- Elliptical irradiation
- R5 : ANUJ6450S
- R7.5: ANUJ6475S

**Rod lens  
ANUJ64\*7L (For standard head)**



- Small diameter circular irradiation
- ø4 mm 0.157 in: ANUJ6447L
- ø6 mm 0.236 in: ANUJ6467L

\*Rod lens combined with ANUJ6186, ANUJ6188 and ANUJ6189 are treated as custom-made products. Please consult us.

**AC adapter (Note 2)  
ANUJ6802**

100 to 240 V AC adapter supplied with the controller unit  
With a 100 V AC power cable

**200 V AC power cable  
ANUJ6803**

200 V AC power cable for ANUJ6802 (Note 3)

**Mounting bracket  
ANUJ6804**

Head mounting bracket  
Material: Aluminum

**Protective glass  
ANUJ6430**

For head protection if lenses are not used.

Notes: 1) The head does not come with a lens.  
 2) The ANUJ6802 AC adapter is supplied with the controller unit. The ANUJ6802 AC adapter is compatible with 100 to 240 V AC; however, the primary-side power cable is compatible with 100 V AC only. For use in a 200 V AC region, purchase the ANUJ6803 primary-side power cable (for 200 V AC) separately.  
 3) For China only. Primary-side A-type plug. (Since this product is not PSE Mark compliant, it cannot be connected directly to a lamp line in Japan.)

## Specifications

Controllers		
Controller Product type	UJ30 (Standard model)	UJ35 (High performance model)
Controller Part No.	ANUJ3000	ANUJ3500
Connectable heads	1 to 4 heads	
Connectable UV sensor	Not compatible	Compatible
UV irradiation	One pattern irradiation in simple mode The heads are either collectively or individually controlled.	One pattern in simple mode and programmed pattern irradiation (up to 7 patterns with up to 10 steps) The heads are either collectively or individually controlled.
Pattern switching	None (1 type)	Switchable (8 types)
Intensity / irradiation control	Digital intensity and irradiation control manual or timer control (0.1 to 99.9, 100 to 999 sec.) Auto-tuning function using the UV sensor (for UJ35 only) Specifications of UV sensor: [Temperature characteristic: ±5 % F.S. (+5 to +35 °C 41 to 95 °F) / Repeat accuracy: ±1 % (25 °C 77 °F)]	
Setting/Operation	Setting by the operation switches and power-on/off by a key switch	Setting by the operation switches, power-on/off by a key switch and RS232C (UJ35 setup tool)
Display	7-segment display	
Cooling system	Natural cooling (without a fan)	
External control	Method	Parallel I/O RS232C, Parallel I/O
	External input	Individual irradiation input, irradiation stop input, interlock, full-irradiation input, pattern switching (for UJ35 only)
	External output	READY signal, error signal, alarm output, BUSY output (each head separately), +5 V output (for indicator)
Operating voltage	With AC adapter: 100 - 240 V AC (±10 %) 50 / 60 Hz 60 VA (at 100 V AC)	
Ambient temperature / humidity range	0 to +35 °C 32 to 95 °F / 30 to 85 % RH (no condensation)	
Storage temperature / humidity range	-10 to +60 °C 14 to 140 °F / 30 to 85 % RH (no condensation)	
Accessories	AC adapter and Key	
Weight	1,180 g approx. (Controller: 940 g approx., AC adapter: 240 g approx.)	1,200 g approx. (Controller: 960 g approx., AC adapter: 240 g approx.)

Heads												
365 nm wavelength high-output head	Head model No.		ANUJ6186									
	Compatible lens	Spot diameter	ø3 mm ø0.118 in	ø4 mm ø0.157 in	ø6 mm ø0.236 in	ø8 mm ø0.315 in	ø10 mm ø0.394 in	Protective glass <sup>*)</sup>				
	Lens model No.	Lens model No.	ANUJ6423	ANUJ6424	ANUJ6426	ANUJ6428	ANUJ6420	ANUJ6430				
	UV intensity (mW/cm <sup>2</sup> ) <sup>*)</sup>		17,200	14,940	7,560	4,450	1,360	530				
365 nm wavelength standard type	Head model No.		ANUJ6180									
	Compatible lens	Spot diameter	ø3 mm ø0.118 in	ø4 mm ø0.157 in	ø6 mm ø0.236 in	ø8 mm ø0.315 in	ø10 mm ø0.394 in	Protective glass <sup>*)</sup>				
	Lens model No.	Lens model No.	ANUJ6423	ANUJ6424	ANUJ6426	ANUJ6428	ANUJ6420	ANUJ6430				
	UV intensity (mW/cm <sup>2</sup> ) <sup>*)</sup>		12,500	10,600	4,720	2,500	580	300				
385 nm wavelength high-output head	Head model No.		ANUJ6188									
	Compatible lens	Spot diameter	ø3 mm ø0.118 in	ø4 mm ø0.157 in	ø6 mm ø0.236 in	ø8 mm ø0.315 in	ø10 mm ø0.394 in	Protective glass <sup>*)</sup>				
	Lens model No.	Lens model No.	ANUJ6423	ANUJ6424	ANUJ6426	ANUJ6428	ANUJ6420	ANUJ6430				
	UV intensity (mW/cm <sup>2</sup> ) <sup>*)</sup>		19,500	16,920	8,860	4,750	1,400	580				
385 nm wavelength standard type	Head model No.		ANUJ6184									
	Compatible lens	Spot diameter	ø3 mm ø0.118 in	ø4 mm ø0.157 in	ø6 mm ø0.236 in	ø8 mm ø0.315 in	ø10 mm ø0.394 in	Protective glass <sup>*)</sup>				
	Lens model No.	Lens model No.	ANUJ6423	ANUJ6424	ANUJ6426	ANUJ6428	ANUJ6420	ANUJ6430				
	UV intensity (mW/cm <sup>2</sup> ) <sup>*)</sup>		14,700	11,700	5,800	2,790	590	330				
405 nm wavelength high-output head	Head model No.		ANUJ6189									
	Compatible lens	Spot diameter	ø3 mm ø0.118 in	ø4 mm ø0.157 in	ø6 mm ø0.236 in	ø8 mm ø0.315 in	ø10 mm ø0.394 in	Protective glass <sup>*)</sup>				
	Lens model No.	Lens model No.	ANUJ6423	ANUJ6424	ANUJ6426	ANUJ6428	ANUJ6420	ANUJ6430				
	UV intensity (mW/cm <sup>2</sup> ) <sup>*)</sup>		20,900	17,800	9,190	5,450	1,790	810				
405 nm wavelength standard type	Head model No.		ANUJ6187									
	Compatible lens	Spot diameter	ø3 mm ø0.118 in	ø4 mm ø0.157 in	ø6 mm ø0.236 in	ø8 mm ø0.315 in	ø10 mm ø0.394 in	Protective glass <sup>*)</sup>				
	Lens model No.	Lens model No.	ANUJ6423	ANUJ6424	ANUJ6426	ANUJ6428	ANUJ6420	ANUJ6430				
	UV intensity (mW/cm <sup>2</sup> ) <sup>*)</sup>		15,500	12,600	5,730	3,150	890	440				
Common item	Light source		Class 3B LED product (JIS S6802:2005) Risk group 3 (ANUJ6189 / ANUJ6187: Risk group 2) (IEC 62471)									
	Estimated light source life <sup>*)</sup>		20,000 hours (when the LED temperature inside the head is 60°C 140°F)									
	Cable length		0.2 m 0.656 ft. A connection cable is required to connect the high-output head to a UJ series controller.									
	Operating temperature and humidity		+5 to +35 °C +41 to +95 °F / 30 to 85 % RH (No condensation)									
Storage temperature and humidity		-10 to +60 °C +14 to +140 °F / 30 to 85 % RH (No condensation)										

Notes: 1) The values were measured using a UJ30 / UJ35 illuminometer with ø1 mm ø0.039 in sensor hole when the high-output heads were fixed to the attachment, the ambient temperature was maintained at 25 °C (77 °F) by the UJ30 / UJ35, and they were turned on with 100% output (initial value; based on Panasonic's reference measurement).  
 Since the LED elements show illumination intensity fluctuations, the actual UV intensity may be more than 20 % higher.  
 2) It is recommended that protective glass (ANUJ6430) be used to protect the head-side lens from contamination when the high-output head is used without a lens. For further information about protective glass, contact our sales office.  
 3) The value is not a guaranteed value.

# Dimensions (Unit: mm in) Excluding the protruding sections

## UJ30 / UJ35

**UJ35 Controller**  
**ANUJ3500**

(Weight: 960 g approx.)

**UJ30 Controller**  
**ANUJ3000**

(Weight: 940 g approx.)

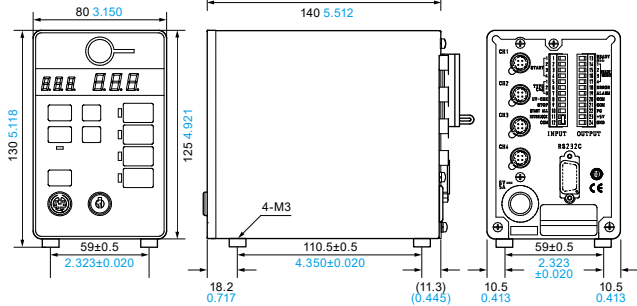

**UV sensor ANUJ3800**

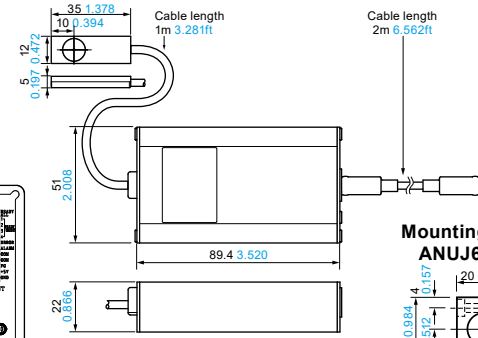

**Mounting bracket for head**  
**ANUJ6804**

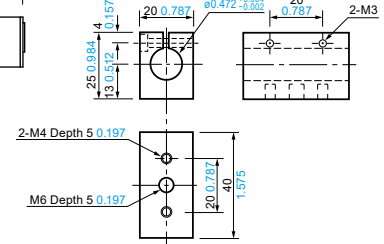

**AC adapter ANUJ6802**

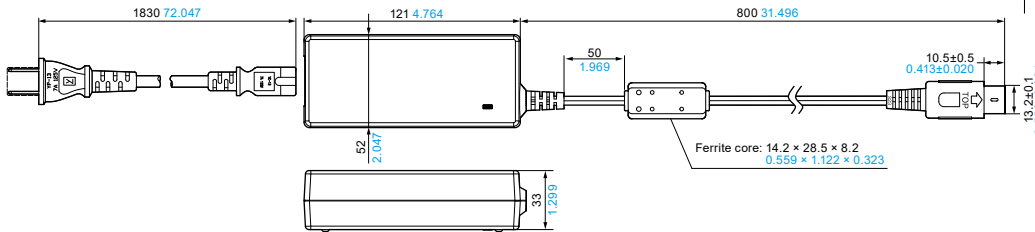

**Head sections (with standard lens)**

**ANUJ6180 / ANUJ6184 / ANUJ6186 / ANUJ6187 / ANUJ6188 / ANUJ6189**

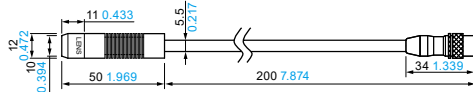

**200V AC power cable ANUJ6803**

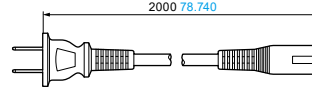

\* Type A plug

**Connection cable**

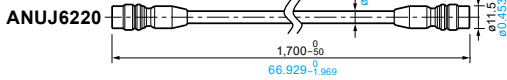

**Standard and Cylindrical lens**

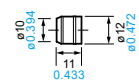

**Rod lens**

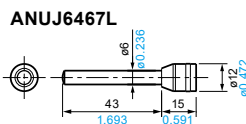

**Side view lens**

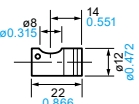

**ANUJ6447L**

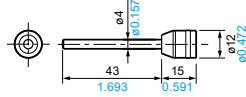

**Protective glass**



## Input and Output specifications

**Input specifications**

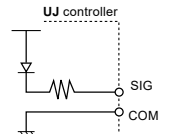

Open collector (Tr) or non-voltage input such as a relay

**Output specifications**

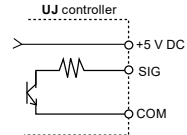

Rated operation voltage: 5 to 24 V DC  
Output capacity: 100 mA (max.)

**I/O list**

INPUT		OUTPUT	
Terminal No.	Signal	Terminal No.	Signal
1	START1	13	READY-All
2	START2	14	READY/BUSY1 (Note 2)
3	START3	15	READY/BUSY2 (Note 2)
4	START4	16	READY/BUSY3 (Note 2)
5	TYPE Chg1 (Note 1)	17	READY/BUSY4 (Note 2)
6	TYPE Chg2 (Note 1)	18	ERROR
7	TYPE Chg3 (Note 1)	19	ALARM
8	UV CHECK (Note 1)	20	COM
9	STOP	21	COM
10	START-All	22	FG
11	INTERLOCK (Note 3)	23	+5 V DC
12	COM	24	COM

Notes: 1) Nos. 5 / 6 / 7 / 8 (Type-Chg 1 / 2 / 3 and UV-CHECK) are functions available UJ35 only.  
These terminals for UJ30 are spare.  
2) The READY/BUSY switching of Nos. 14 / 15 / 16 / 17 is performed on the UJ30 / UJ35 controller.  
3) At shipment, for B-contact (allows irradiation when ON), No.11 (INTERLOCK) is connected to No.12 (COM) by a short-circuit line.

## Configuration

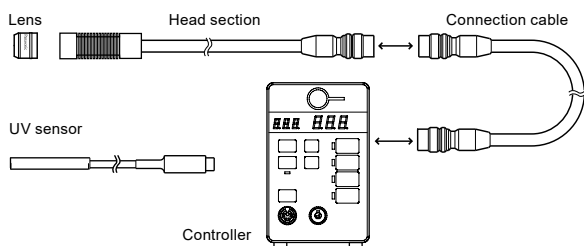

Four heads can be simultaneously connected to one controller.

# Panasonic original LED provides a UV intensity\* of 4,600 mW/cm<sup>2</sup>.

\* Wavelength: 385 nm 0.015 mil, Irradiation distance: 10 mm 0.394 in  
Based on our company's measurement standards. Values are typical, but not guaranteed.

The wavelength 365 nm 0.014 mil type and 385 nm 0.015 mil type are available.



## Air cooling method

Water cooling equipment is not required since the unit is fan-cooled.  
Compact equipment makes installation easy.

■ **Illumination profile (Example)** Note: The intensity profiles shown are representative values, not guaranteed values.

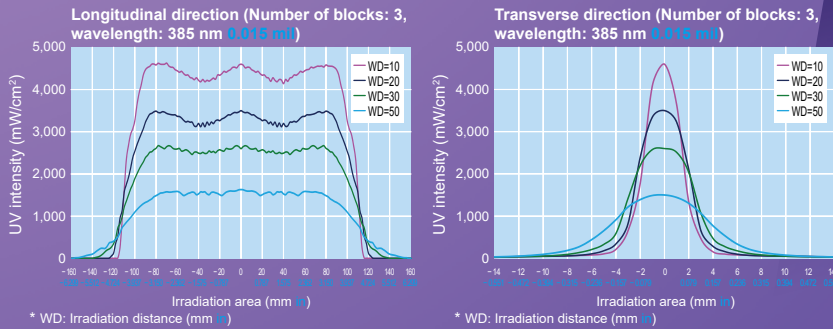

## Multiple Size Variations

Six sizes are available for use in various applications.

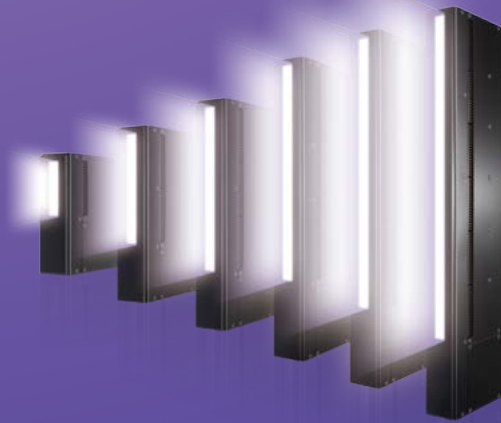

## Compact Size Makes Installation Easier

This compact equipment can be installed in a small space. Provides greater flexibility in choosing the installation location



## Why is the UV intensity high?

**Reason 1** The LED's capabilities are maximized by its cooling structure and a small size was also achieved.

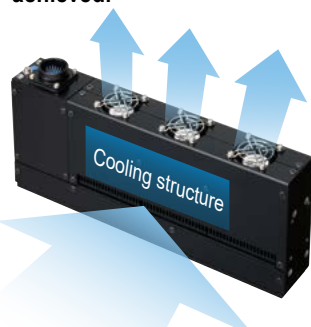

**Reason 2** It has high light density due to its optical design. Further, it also enables long distance irradiation.

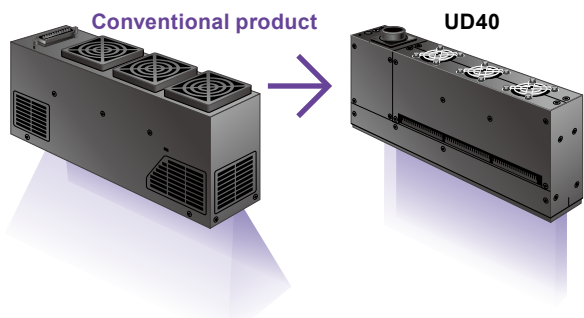

# Flexible UV Irradiation Patterns

## Block-level UV intensity control

UV irradiation can be controlled separately for each block in the head. This enables UV irradiation according to the workpiece shape and also reduces power consumption by turning off the LEDs where UV irradiation is not needed.

### UV irradiation pattern example (6 blocks)

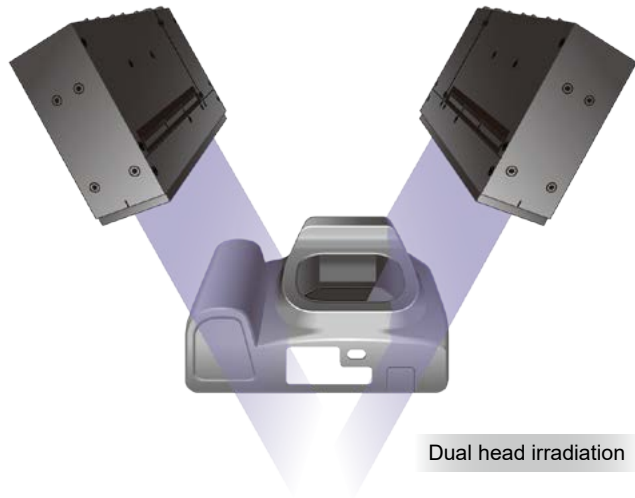
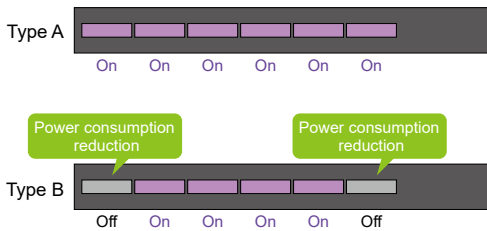

## UV Irradiation Stability

No more resin curing defects or adhesion errors

### Temperature feedback control

Panasonic's original

Provides UV irradiation accuracy within  $\pm 5\%$ .  
(at 80 % UV intensity setting)

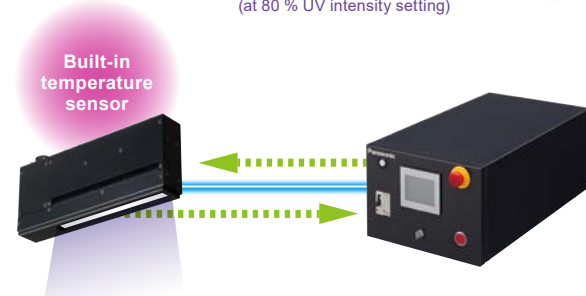

Generally, an increase in LED temperature reduces the UV irradiation output. However, the UD40 series employs a Panasonic original head cooling mechanism to suppress temperature increases. Further, a temperature sensor is built into the head to constantly monitor and feed back temperature information. This has resulted in a superb UV irradiation stability within  $\pm 5\%$  for output up to 80 %. This is ideal for high quality, precise adhesion applications.

### Typical characteristics (25 °C 77 °F atmosphere)

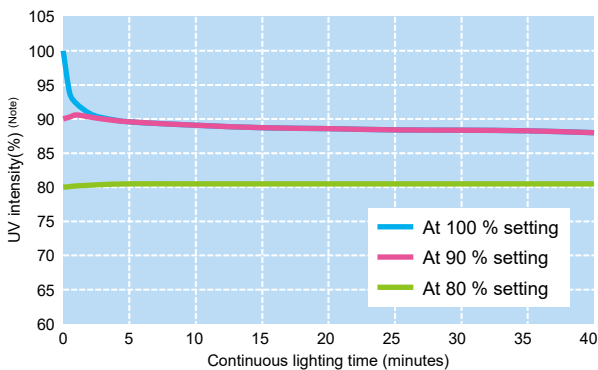

## External Access Control

Control UV irradiation from an external device. UV irradiation can be applied only during the required time period.

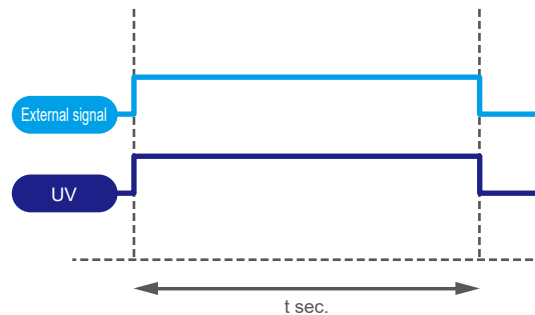
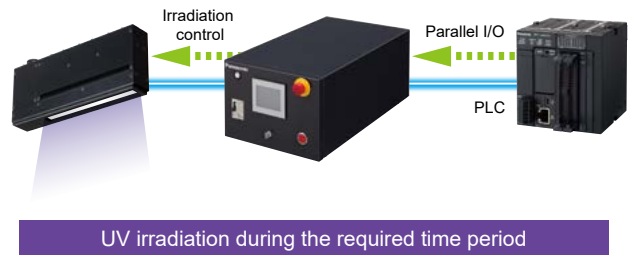

UV irradiation continues during the time period (t sec.) that the external signal is on. UV irradiation stops when the signal is turned off.

UV irradiation from the head can be controlled using a parallel signal from a PLC or other external device.

Note: From detection of external signal ON, up to about 500 msec is required for UV illumination to reach the set value (necessary for overcurrent protection).

# Operating Time and Temperature Display Functions

## Notification of LED replacement period and abnormal temperature

The number of hours of lighting is counted for each LED block in the head. When a specific number of hours is reached, the LED replacement period is indicated through the controller's external output and panel display. In addition, because the head has a built-in temperature sensor, the LED temperature during operation can be displayed. If an abnormal temperature is detected, the controller sends a warning through its external output and panel display. These functions ensure safety and improve productivity.

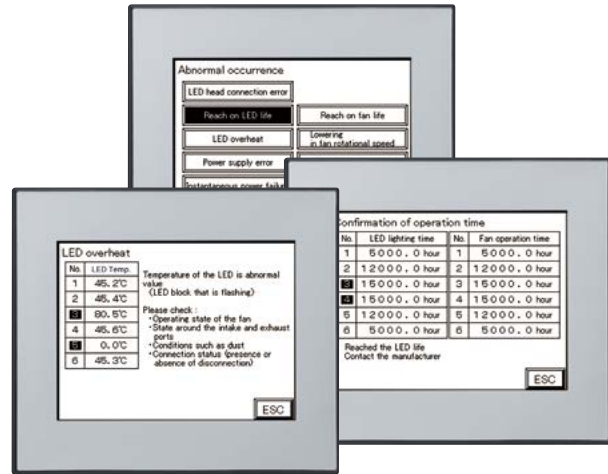

## Long-life, Economical LED Type

### LED type makes frequent replacement of service parts unnecessary.

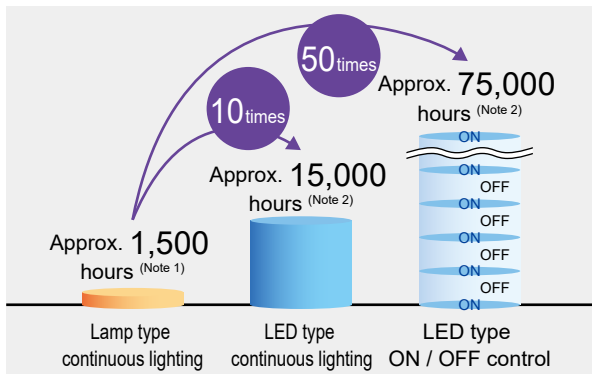

The LED type features extremely long light-source life span compared to the lamp type. As compared to the estimated lamp life span of 1,500 hours (Note 1), the estimated LED life span is 15,000 hours (Note 2).

Furthermore, unlike the lamp type that remains on at all times, the LED type can be turned on only when UV irradiation is needed. If the irradiation on/off time ratio is 1:4 (process takt time = 5, irradiation time = 1), this calculates to a life span of approximately 75,000 hours (Note 2), which can drastically reduce running cost and maintenance man-hours.

Notes: 1) Our straight tube type  
2) At an ambient operating temperature of +25 °C +77 °F

## Low Power Consumption at 100 W per LED Block

### Reduces running cost and CO<sub>2</sub>

Even when six blocks in a single head are turned on, the maximum power consumption is 650 W (at 200 V AC). This effectively reduces power consumption and CO<sub>2</sub> emission. Since less heat is generated than the lamp type, even when the system is used in a small clean room, the increase in room temperature is small. This reduces the power needed for air conditioning.

## Eco product compliant with CE, RoHS, etc.



Unlike lamp type, LED type heads do not contain mercury. UD40 conform to CE Marking, RoHS Directive, and Management Methods for Controlling Pollution by Electronic Information Products (China RoHS), ensuring environmentally safe use. (Please follow the proper industrial waste disposal procedures.)

## Proposal

**Switching from lamp type UD40**

Long term light source  
Exhaust air duct not required  
Space-saving  
Power saving

**Switching from spot type connection style to line type UD40**

UV intensity distribution of spot type (Typical example)  
ANUJ6180 (standard type) + ANUJ6450S (wavelength: 365 nm 0.014 mil, irradiation distance 20 mm 0.787 in)

UV intensity distribution of line type (Typical example)  
UD40 (Number of blocks: 2, wavelength: 365 nm 0.014 mil, irradiation distance: 30 mm 1.181 in)

- High UV intensity
- Long distance irradiation is also possible
- Improvement in UV intensity uniformity

# Product Components

## With single head

### ■ Number of head blocks: 1 to 3

·Head 

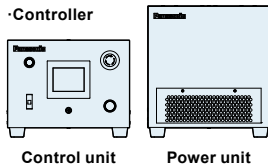

### ■ Number of head blocks: 4 to 6

·Head 

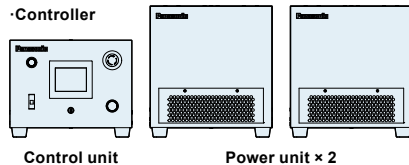

## With dual head

### ■ Number of blocks in head 1: 1 to 3, number of blocks in head 2: 1 to 3

·Head 

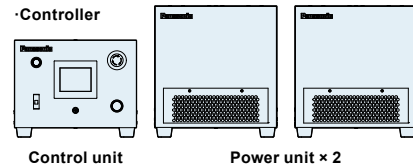

## With dual head

### ■ Number of blocks in head 1: 1 to 3, number of blocks in head 2: 4 to 6

### ■ Number of blocks in head 1: 4 to 6, number of blocks in head 2: 1 to 3

·Head 

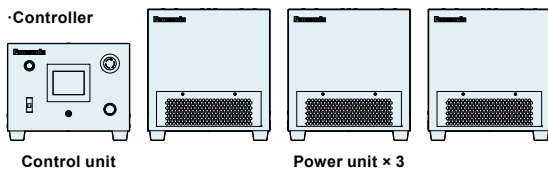

### ■ Number of blocks in head 1: 4 to 6, number of blocks in head 2: 4 to 6

·Head 

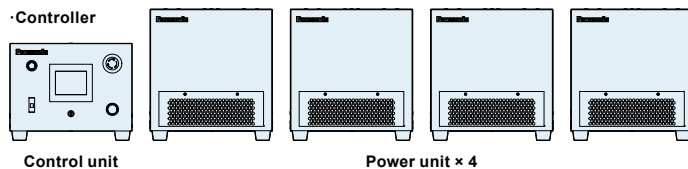

# Specifications

## Common head specifications

Item	Head part No.	Wavelength: 365 nm 0.014 mil					
		ANUD4A111		ANUD4A211		ANUD4A311	
		ANUD4B111		ANUD4B211		ANUD4B311	
		ANUD4B411		ANUD4B511		ANUD4B611	
Number of blocks		1		2		3	
Light source		365 nm ±10 nm 0.014 mil ±0.0004 mil / 385 nm ±10 nm 0.015 mil ±0.0004 mil					
Peak irradiation intensity	Irradiation distance: 10 mm 0.394 in	2,100 mW/cm <sup>2</sup> (Wavelength: 365 nm 0.014 mil) / 2,500 mW/cm <sup>2</sup> (Wavelength: 385 nm 0.015 mil)					
Initial guaranteed value <sup>(Note 1)</sup>	Irradiation distance: 30 mm 1.181 in	1,100 mW/cm <sup>2</sup> (Wavelength: 365 nm 0.014 mil) / 1,400 mW/cm <sup>2</sup> (Wavelength: 385 nm 0.015 mil)					
Peak irradiation intensity	Irradiation distance: 10 mm 0.394 in	4,200 mW/cm <sup>2</sup> (Wavelength: 365 nm 0.014 mil) / 4,600 mW/cm <sup>2</sup> (Wavelength: 385 nm 0.015 mil)					
Typical value <sup>(Note 2)</sup>	Irradiation distance: 30 mm 1.181 in	2,300 mW/cm <sup>2</sup> (Wavelength: 365 nm 0.014 mil) / 2,600 mW/cm <sup>2</sup> (Wavelength: 385 nm 0.015 mil)					
Effective irradiation width <sup>(Note 2)</sup>	Irradiation distance: 10 mm 0.394 in	36 mm 1.417 in	108 mm 4.252 in	180 mm 7.087 in	252 mm 9.921 in	324 mm 12.756 in	396 mm 15.591 in
	Irradiation distance: 30 mm 1.181 in	16 mm 0.630 in	88 mm 3.465 in	160 mm 6.299 in	232 mm 9.134 in	304 mm 11.968 in	376 mm 14.803 in
Estimated head life expectancy <sup>(Note 2)</sup>		15,000 hours (70 % for initial UV intensity)					
Ambient operating temperature / ambient operating humidity		0 to +35 °C +32 to +95 °F / 30 to 85 % RH (no dew condensation or icing allowed)					
Storage temperature / storage humidity		-10 to +60 °C +14 to +140 °F / 30 to 85 % RH (no dew condensation or icing allowed)					
Cooling method		Fan-forced air cooling					
Outer finishing		Matte black painting					
Accessories		Power supply wiring connector *Connection cable not supplied. If only a head is purchased, please also prepare a constant-current power supply for the LED, a constant-voltage power supply for the fan and connection cable, etc.					

Notes: 1) Based on our company's measurement standards. Values are initial guaranteed values, but not representative values.

2) Based on our company's measurement standards. Values are typical, but not guaranteed.

## Common controller specifications

Item	Controller part No.	ANUD4S□
Input supply voltage		1ø 200 to 240 V AC
Input supply frequency		50 to 60 Hz
AC inlet		Terminal block (terminal block screw diameter: ø4 mm ø0.16 in) <sup>(Note 1)</sup>
No. of irradiation program patterns		32 patterns <sup>(Note 2)</sup>
Display, setting, operation		Display, setting, operation from the touch screen
External control	Type	Parallel I/O (D-Sub37) <sup>(Note 3)</sup>
	External input	LED lighting, program selection, LED block individual lighting, local or remote selection, external emergency stop
	External output	Equipment power ON, irradiation preparation complete, irradiating, alert, error, main unit emergency stop
Dimming control <sup>(Note 2)</sup>		50 to 100 % (in increments of 1 %)
LED temperature feedback		A function that senses the temperature of the LED head section and maintains constant UV intensity
Ambient operating temperature / ambient operating humidity		0 to +35 °C +32 to +95 °F / 30 to 85 % RH (no dew condensation or icing allowed)
Storage temperature / storage humidity		-10 to +60 °C +14 to +140 °F / 30 to 85 % RH (no dew condensation or icing allowed)
Cooling method		Control unit: Fan-less natural air cooling, Power unit: Fan-forced air cooling
Configuration		Separation of control unit equipped with PLC and power supply for LED lighting
Outer finishing		Matte black painting
Accessories	Control unit	Power key, D-Sub37 connector
	Power unit	Signal cable (1 m 3.281 ft), AC connection cable (1 m 3.281 ft), LED head connection cable (5 m 16.404 ft)

Notes: 1) Prepare a separate power supply cable (AC supply cable) with a diameter appropriate for the maximum input current.

2) Setting from the touch screen.

3) Prepare a separate cable for connecting to the D-Sub37 connector.

# Specifications

## Individual specifications

### With single head

Number of blocks		1	2	3	4	5	6
Head part No.	Wavelength: 365 nm 0.014 mil	ANUD4A111	ANUD4A211	ANUD4A311	ANUD4A411	ANUD4A511	ANUD4A611
	Wavelength: 385 nm 0.015 mil	ANUD4B111	ANUD4B211	ANUD4B311	ANUD4B411	ANUD4B511	ANUD4B611
Controller part No.		ANUD4S10	ANUD4S20	ANUD4S30	ANUD4S40	ANUD4S50	ANUD4S60
No. of control units		1					
No. of power units		1			2		
Maximum input current		1 A	2 A	3 A	4 A	5 A	6 A
Maximum power consumption		150 W	250 W	350 W	450 W	550 W	650 W
Weight <sup>(Note)</sup>	Head	1.3 kg approx.	1.8 kg approx.	2.3 kg approx.	3.0 kg approx.	3.5 kg approx.	4.0 kg approx.
	Control unit	10 kg approx.					
	Power unit-1	10 kg approx.	12 kg approx.	14 kg approx.			
	Power unit-2	—			10 kg approx.	12 kg approx.	14 kg approx.

Note: Excluding connectors and cables.

### With dual head (Combinations of [1 to 6 blocks in Head 1] and [1 to 3 blocks in Head 2])

		Number of blocks (Head 1)						
		1	2	3	4	5	6	
Number of blocks (Head 2)	1	Controller part No.	ANUD4S11	ANUD4S21	ANUD4S31	ANUD4S41	ANUD4S51	ANUD4S61
		No. of control units	1					
		No. of power units	2			3		
		Maximum input current	2 A	3 A	4 A	5 A	6 A	7 A
		Maximum power consumption	250 W	350 W	450 W	550 W	650 W	750 W
		Weight <sup>(Note)</sup>	Head 1	1.3 kg approx.	1.8 kg approx.	2.3 kg approx.	3.0 kg approx.	3.5 kg approx.
	Head 2		1.3 kg approx.					
	Control unit		10 kg approx.					
	Power unit-1		10 kg approx.	12 kg approx.	14 kg approx.			
	Power unit-2		—			10 kg approx.	12 kg approx.	14 kg approx.
	Power unit-3		10 kg approx.					
	2	Controller part No.	ANUD4S12	ANUD4S22	ANUD4S32	ANUD4S42	ANUD4S52	ANUD4S62
		No. of control units	1					
		No. of power units	2			3		
		Maximum input current	3 A	4 A	5 A	6 A	7 A	8 A
		Maximum power consumption	350 W	450 W	550 W	650 W	750 W	850 W
		Weight <sup>(Note)</sup>	Head 1	1.3 kg approx.	1.8 kg approx.	2.3 kg approx.	3.0 kg approx.	3.5 kg approx.
	Head 2		1.8 kg approx.					
Control unit	10 kg approx.							
Power unit-1	10 kg approx.		12 kg approx.	14 kg approx.				
Power unit-2	—			10 kg approx.	12 kg approx.	14 kg approx.		
Power unit-3	12 kg approx.							
3	Controller part No.	ANUD4S13	ANUD4S23	ANUD4S33	ANUD4S43	ANUD4S53	ANUD4S63	
	No. of control units	1						
	No. of power units	2			3			
	Maximum input current	4 A	5 A	6 A	7 A	8 A	9 A	
	Maximum power consumption	450 W	550 W	650 W	750 W	850 W	950 W	
	Weight <sup>(Note)</sup>	Head 1	1.3 kg approx.	1.8 kg approx.	2.3 kg approx.	3.0 kg approx.	3.5 kg approx.	4.0 kg approx.
Head 2		2.3 kg approx.						
Control unit		10 kg approx.						
Power unit-1		10 kg approx.	12 kg approx.	14 kg approx.				
Power unit-2		—			10 kg approx.	12 kg approx.	14 kg approx.	
Power unit-3		14 kg approx.						

Note: Excluding connectors and cables.



# Specifications

## Individual specifications

With dual head (Combinations of [1 to 6 blocks in Head 1] and [4 to 6 blocks in Head 2])

		Number of blocks (Head 1)							
		1	2	3	4	5	6		
Number of blocks (Head 2)	4	Controller part No.	ANUD4S14	ANUD4S24	ANUD4S34	ANUD4S44	ANUD4S54	ANUD4S64	
		No. of control units	1						
		No. of power units	3			4			
		Maximum input current	5 A	6 A	7 A	8 A	9 A	10 A	
		Maximum power consumption	550 W	650 W	750 W	850 W	950 W	1,050 W	
		Weight <sup>(Note)</sup>	Head 1	1.3 kg approx.	1.8 kg approx.	2.3 kg approx.	3.0 kg approx.	3.5 kg approx.	4.0 kg approx.
			Head 2	3.0 kg approx.					
			Control unit	10 kg approx.					
			Power unit-1	10 kg approx.	12 kg approx.	14 kg approx.			
	Power unit-2		—			10 kg approx.	12 kg approx.	14 kg approx.	
	Power unit-3		14 kg approx.						
	Power unit-4	10 kg approx.							
	5	Controller part No.	ANUD4S15	ANUD4S25	ANUD4S35	ANUD4S45	ANUD4S55	ANUD4S65	
		No. of control units	1						
		No. of power units	3			4			
		Maximum input current	6 A	7 A	8 A	9 A	10 A	11 A	
		Maximum power consumption	650 W	750 W	850 W	950 W	1,050 W	1,150 W	
		Weight <sup>(Note)</sup>	Head 1	1.3 kg approx.	1.8 kg approx.	2.3 kg approx.	3.0 kg approx.	3.5 kg approx.	4.0 kg approx.
			Head 2	3.5 kg approx.					
			Control unit	10 kg approx.					
			Power unit-1	10 kg approx.	12 kg approx.	14 kg approx.			
Power unit-2	—			10 kg approx.	12 kg approx.	14 kg approx.			
Power unit-3	14 kg approx.								
Power unit-4	12 kg approx.								
6	Controller part No.	ANUD4S16	ANUD4S26	ANUD4S36	ANUD4S46	ANUD4S56	ANUD4S66		
	No. of control units	1							
	No. of power units	3			4				
	Maximum input current	7 A	8 A	9 A	10 A	11 A	12 A		
	Maximum power consumption	750 W	850 W	950 W	1,050 W	1,150 W	1,250 W		
	Weight <sup>(Note)</sup>	Head 1	1.3 kg approx.	1.8 kg approx.	2.3 kg approx.	3.0 kg approx.	3.5 kg approx.	4.0 kg approx.	
		Head 2	4.0 kg approx.						
		Control unit	10 kg approx.						
		Power unit-1	10 kg approx.	12 kg approx.	14 kg approx.				
Power unit-2		—			10 kg approx.	12 kg approx.	14 kg approx.		
Power unit-3		14 kg approx.							
Power unit-4	14 kg approx.								

Note: Excluding connectors and cables.

# Dimensions (Unit: mm in)

## ANUD4A□ ANUD4B□

### Heads

■ Number of blocks: 1 to 3

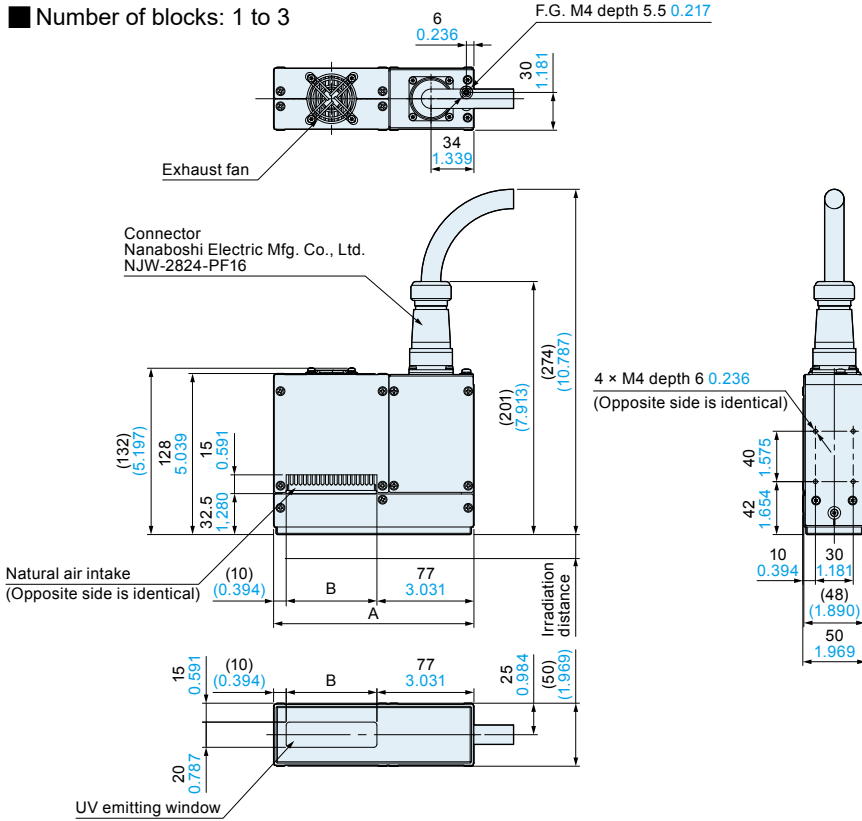

Head Part No.	Wavelength: 365 nm 0.014 mil	ANUD4A111	ANUD4A211	ANUD4A311
	Wavelength: 385 nm 0.015 mil	ANUD4B111	ANUD4B211	ANUD4B311
Number of blocks		1	2	3
Effective irradiation width	Irradiation distance: 10 mm 0.394 in	36 1.417	108 4.252	180 7.087
	Irradiation distance: 30 mm 1.181 in	16 0.630	88 3.465	160 6.299
External dimensions	Width	50 1.969		
	Height	(142 5.591) (with receptacle, without connector and cable)		
	A (Length)	159 6.260	231 9.094	303 11.929
	B	72 2.835	144 5.669	216 8.504

■ Number of blocks: 4 to 6

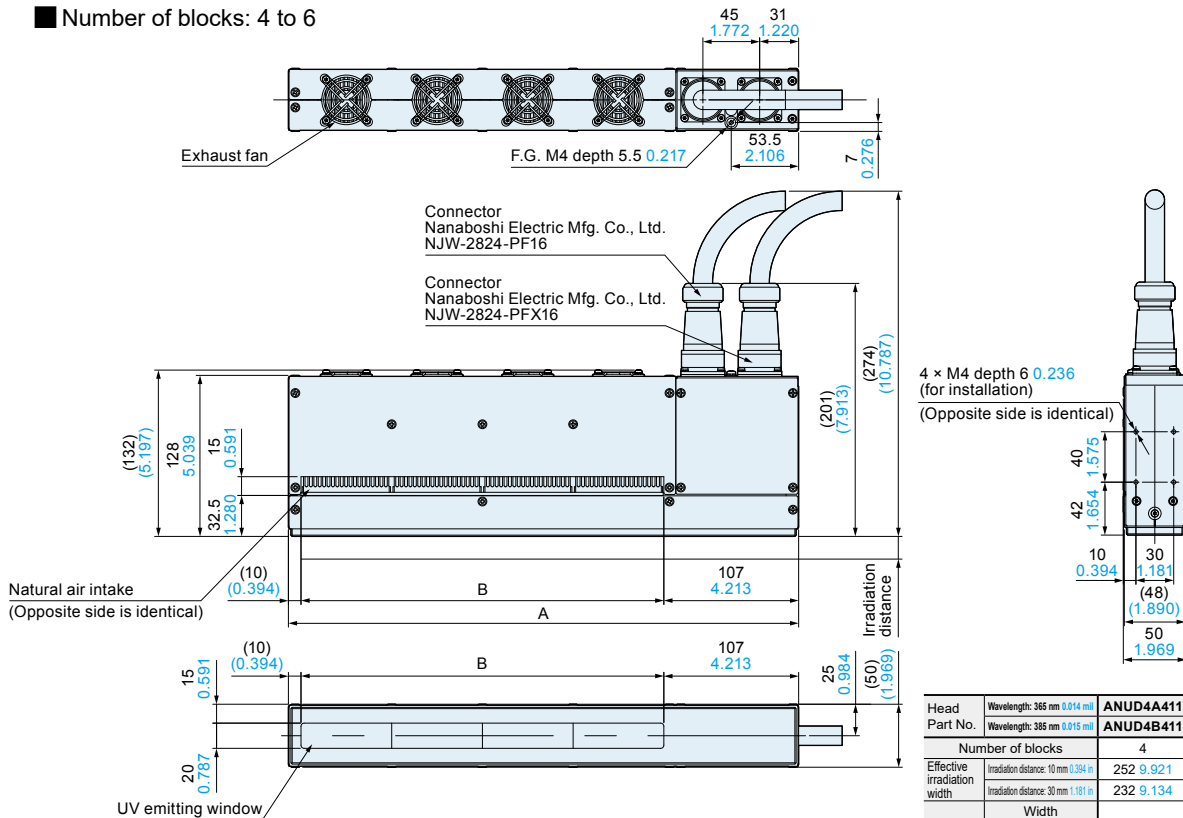

Head Part No.	Wavelength: 365 nm 0.014 mil	ANUD4A411	ANUD4A511	ANUD4A611
	Wavelength: 385 nm 0.015 mil	ANUD4B411	ANUD4B511	ANUD4B611
Number of blocks		4	5	6
Effective irradiation width	Irradiation distance: 10 mm 0.394 in	252 9.921	324 12.756	396 15.591
	Irradiation distance: 30 mm 1.181 in	232 9.134	304 11.968	376 14.803
External dimensions	Width	50 1.969		
	Height	(142 5.591) (with receptacle, without connector and cable)		
	A (Length)	405 15.945	477 18.779	549 21.614
	B	288 11.339	360 14.173	432 17.008

# Dimensions (Unit: mm in)

## ANUD4S□ Controllers

### ■ Control unit

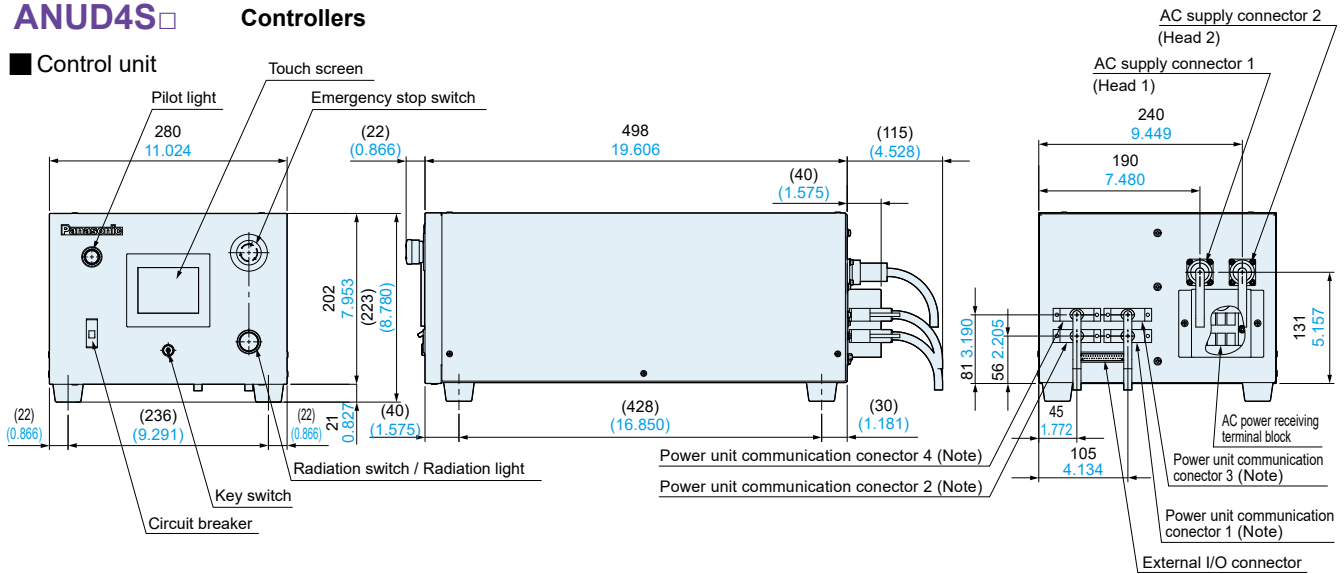

Note: The position and number of power unit communication connectors depend on the number of connected power units. See the chart on the right for the corresponding models. (Figure above shows an example of using 4 power units)

**Power unit communication connector availability chart**

	Controller part No.						
	ANUD4S10	ANUD4S40	ANUD4S11	ANUD4S14	ANUD4S41	ANUD4S44	
Power unit communication connector	ANUD4S20	ANUD4S50	ANUD4S12	ANUD4S15	ANUD4S42	ANUD4S45	
	ANUD4S30	ANUD4S60	ANUD4S13	ANUD4S16	ANUD4S43	ANUD4S46	
			ANUD4S21	ANUD4S24	ANUD4S51	ANUD4S54	
			ANUD4S22	ANUD4S25	ANUD4S52	ANUD4S55	
			ANUD4S23	ANUD4S26	ANUD4S53	ANUD4S56	
			ANUD4S31	ANUD4S34	ANUD4S61	ANUD4S64	
			ANUD4S32	ANUD4S35	ANUD4S62	ANUD4S65	
			ANUD4S33	ANUD4S36	ANUD4S63	ANUD4S66	
	No. of power units	1	2	2	3	3	4
	Power unit communication connector 1	Available	Available	Available	Available	Available	Available
Power unit communication connector 2	None	Available	None	None	Available	Available	
Power unit communication connector 3	None	None	Available	Available	Available	Available	
Power unit communication connector 4	None	None	None	Available	None	Available	

### ■ Power unit

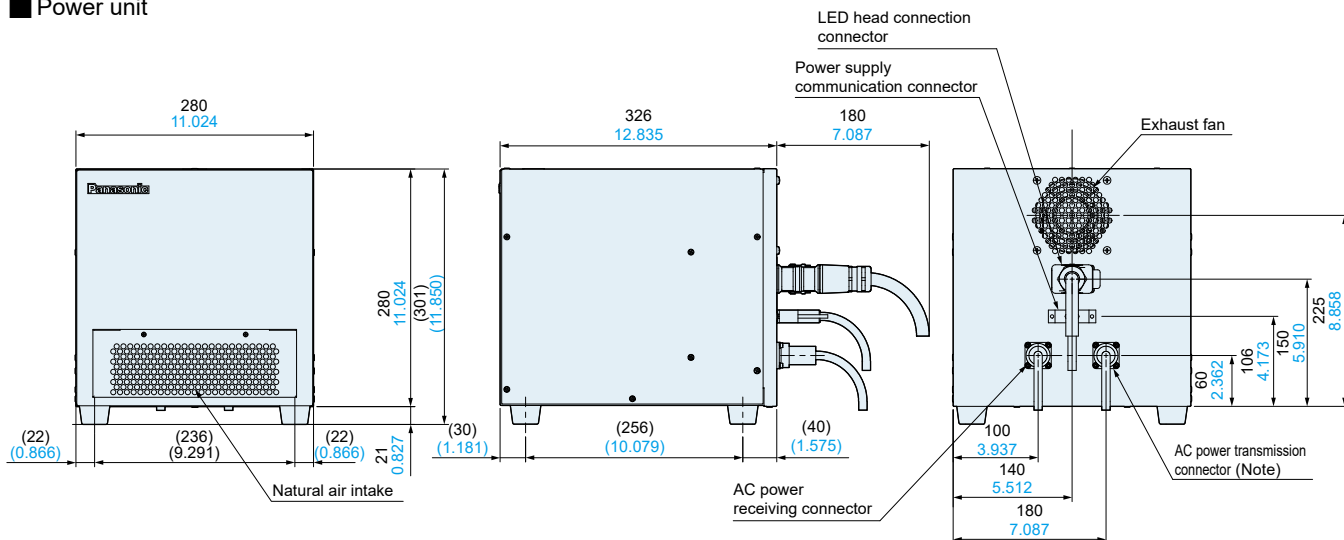

Note: Whether an AC transmission connector is used depends on the controller model. See the chart on the right for information on which models use AC transmission connectors. (Figure above shows an example of using an AC transmission connector)

**AC power transmission connector availability chart** — : Power unit not available

	Controller part No.						
	ANUD4S10	ANUD4S40	ANUD4S11	ANUD4S14	ANUD4S41	ANUD4S44	
AC transmission connector used / not used	ANUD4S20	ANUD4S50	ANUD4S12	ANUD4S15	ANUD4S42	ANUD4S45	
	ANUD4S30	ANUD4S60	ANUD4S13	ANUD4S16	ANUD4S43	ANUD4S46	
			ANUD4S21	ANUD4S24	ANUD4S51	ANUD4S54	
			ANUD4S22	ANUD4S25	ANUD4S52	ANUD4S55	
			ANUD4S23	ANUD4S26	ANUD4S53	ANUD4S56	
			ANUD4S31	ANUD4S34	ANUD4S61	ANUD4S64	
			ANUD4S32	ANUD4S35	ANUD4S62	ANUD4S65	
			ANUD4S33	ANUD4S36	ANUD4S63	ANUD4S66	
	No. of power units	1	2	2	3	3	4
	Power unit-1	None	Available	None	None	Available	Available
Power unit-2	—	None	—	—	None	None	
Power unit-3	—	—	None	Available	None	Available	
Power unit-4	—	—	—	None	—	None	

# Energy-efficient mode will cut power consumption by maximum of 15 % when the irradiation is off. Also featuring high-accuracy auto-tuning function



## High-efficiency UV irradiation

### Eco mode reduces power consumption.

The Eco mode cuts the standby power consumption by a maximum of 15 % while the irradiation is off (the shutter is closed), contributing to the running costs (electricity charge). Compatible with a wide range of power supply voltages from 100 to 240 V AC for worldwide use.

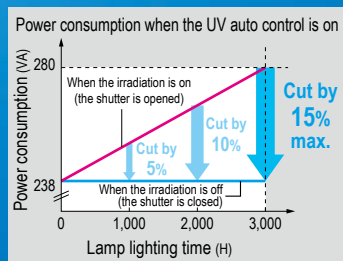

### Surface tackiness can be quickly eliminated.

The development and adoption of our unique special mirror that allows for the effective irradiation with short wavelengths enables the quick elimination of surface stickiness caused during curing. The irradiation time can also be reduced, decreasing the temperature rise of workpieces.

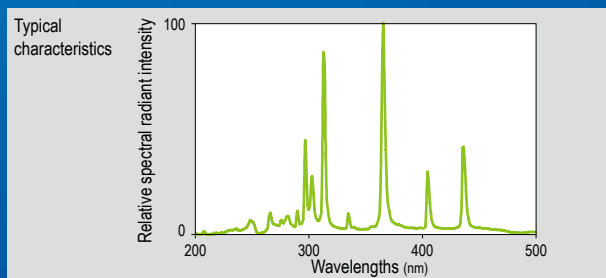

## ANUP5001F heat ray cut filter prevents temperature rises in the irradiation unit.

The use of the filter is recommended especially for heat-sensitive workpieces. You can reduce temperature rises in the irradiation unit by attaching a heat reflecting filter depending on the type of workpiece.

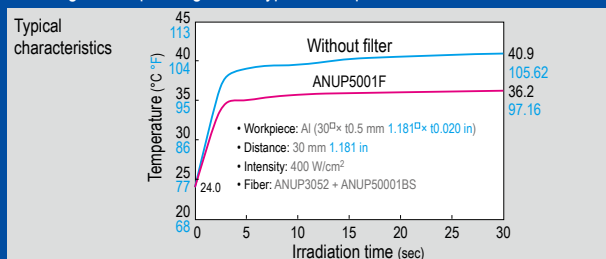

## Stable UV irradiation performance

### UV auto control function automatically compensates for the UV intensity

This function increases the electrical power applied to the lamp according to the total irradiation time of the lamp to compensate for the UV intensity decrease, maintaining stable UV irradiation until the end of the lamp life.

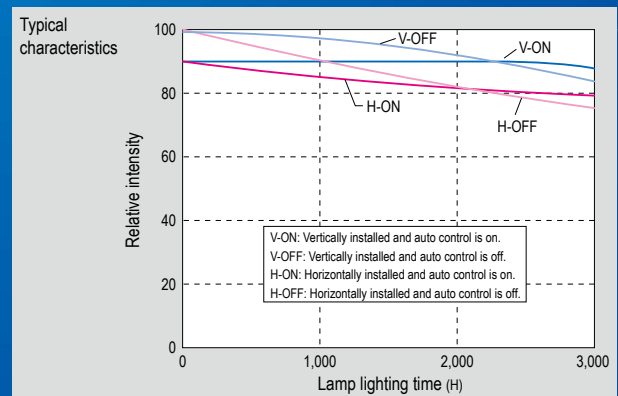

### Significantly higher reliability for bonding and fixing



## Slim UV sensor

The UV sensor for measuring irradiation intensity enables auto-turning in high-accuracy.



The UV intensity can be relative measured<sup>(Note 1)</sup> at the actual position by using the slim UV sensor. It can also automatically adjust the UV intensity to the preset level. Since the sensor only has 5 mm (0.197 in) thickness, which is similar to the workpiece, the intensity measurement is possible without removing the system from the production line, facilitating

high-accuracy setting and in-line condition optimization. The UV intensity can be checked and adjusted at real time, enhancing the bonding and fixing reliability.

Notes: 1) UV intensity can be measured as a relative value.  
 2) Because sensitivity adjustment of the UV sensor is carried out at 365 nm single wavelength, depending on the spectral sensitivity characteristics of the UV resin being used, it may not be possible to fully control the curing process. For more information, please consult us.

## Stable UV irradiation performance

### Programmable irradiation function

This function prevents curing distortion and enables high-quality precision bonding.

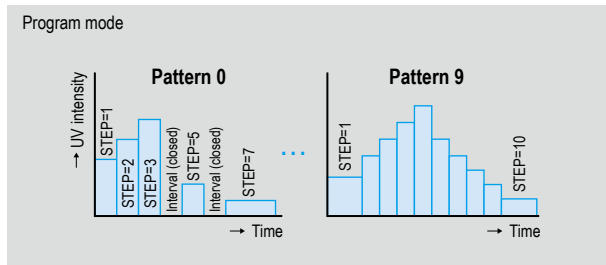

The irradiation can be programmed to controls the irradiation power and time depending on the resin and curing application, supporting high-quality and high-precision bonding with minimum cure shrinkage. In addition to the simple irradiation mode which irradiation is continuously performed at a constant intensity, up to 10 steps 10 patterns can be set. This includes the step-up mode which the intensity is changed over time and the interval mode which irradiation is performed at specified intervals.

### Digital setting allows for consistency of set values from operator to operator.

The irradiation power can be finely set in the range of 0 to 100 % in increments of 0.5 %. The actual UV irradiation intensity is approximately proportional to the displayed value, making the setting work easier and more accurate.

### Interchangeability with ANUP5204

The wavelength distribution (typical characteristics) of **UP50** is identical to **ANUP5204**, our existing model. The replacement lamp, the **ANUPS204**, is also the same as that for the **ANUP5204**.

## Specifications

Part No.	<b>ANUP50</b>
Power supply	90 to 264 V AC 50 / 60 Hz 280 VA
Lamp	Lamp Part No. <b>ANUPS204</b>
	200 W mercury xenon lamp, preset quickly-attachable type Notes: 1) Average life of 3,000 hours: Ratio to the initial UV intensity -- 80% or higher in a vertical position, 70 % or higher in a horizontal position (when the auto control function is off) 2) Guaranteed life: 2,000 hours
Ambient temperature / ambient humidity	+10 to +40 °C +50 to +104 °F / Max. 80 % RH (no condensation)
Accessories	Lamp ( <b>ANUPS204</b> ) Power cord (3 m 9.843 ft, 100 V AC compatible, plug with 2-pole ground)

## Easy to install

### Can be placed either vertically or horizontally .

The unit can be placed in either a vertical position that makes the footprint smaller or a horizontal position that allows stacking other units.



### Long life, quickly-attachable lamp

The average lamp life is 3,000 hours (guaranteed life: 2,000 hours<sup>(Note)</sup>). The lamp can be easily replaced with a single operation and does not require an optical axis adjustment.

Note: Ratio to the initial UV intensity -- 80 % or higher in vertical placement, 70 % or higher in horizontal placement



### Two lens unit models for short and long range converging

The two lens unit models, one for short range and the other for long range converging, cover a variety of applications and workpieces.

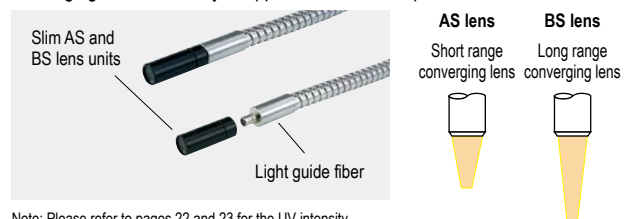

Note: Please refer to pages 22 and 23 for the UV intensity distribution data.

UV irradiation	UV intensity adjustment by digital setting (0 to 100 %, in increments of 0.5 %)
	UV auto control
	Programmable irradiation (10 steps in each of 10 patterns) External signal control: Turning the lamp on/off, manual opening/closing of the shutter, starting programmed pattern irradiation, starting timer-controlled irradiation, and executing calibration
Shutter	Electronically-controlled shutter using manual or timer-controlled operation
Setting	Digital setting using membrane switches
External signal	Input: Opening/closing the shutter (timer/manual), lighting the lamp
	Output: Lighting the lamp, stabilizing the lamp light, opening the shutter, outputting error signals, and indicating the lamp life
Dimensions	165 × 201 × 325 mm 6.496 × 7.913 × 12.795 in (Excluding protruding sections)
Weight	8 kg approx.

Note: Please refer to page 22 for the light guide fiber units and other optional parts.

# Options

## Light guide fiber units

Number of branches	1	2	3	4
Shape				
Bundle diameter: ø3.5 mm ø0.138 in (light outlet end)	<b>ANUP5031</b>	<b>ANUP5032</b>	<b>ANUP5033</b>	<b>ANUP5034</b>
Bundle diameter: ø5 mm ø0.197 in (light outlet end)	<b>ANUP5051</b>	<b>ANUP5052</b>	<b>ANUP5053</b>	<b>ANUP5054</b>
Bundle diameter: ø8 mm ø0.315 in (light outlet end)	<b>ANUP5081</b>			

Note: The custom-made correspondence with the line type light outlet shape is also possible. For more information, please consult us.

## Others

Product name	Specifications	Part No.
Lens <sup>(Note)</sup>	Short range converging lens	<b>ANUP5001AS</b>
	Long range converging lens	<b>ANUP5001BS</b>
	Cylindrical lens	Custom-made product
Heat ray cut filter	Reflection type	<b>ANUP5001F</b>
Lamp	For <b>UP50</b>	<b>ANUPS204</b>
Lamp lead wire	For <b>UP50</b>	<b>ANUPS50H2</b>
UV sensor	Slim type (Thickness: 5 mm 0.197 in) ( <b>ANUJ38102</b> is attached.)	<b>ANUJ3800</b>
UV sensor extension cable	Length: 10 m 32.808 ft	<b>ANUJ38110</b>
	Length: 2 m 6.562 ft (Equivalent to the cable attached with <b>ANUJ3800</b> )	<b>ANUJ38102</b>

Note: Please consult us separately for the lens for the ø8 mm ø0.315 in fiber unit.

# Dimensions

(Unit: mm in) Excluding the protruding sections

## UP50

### UP50 Controller

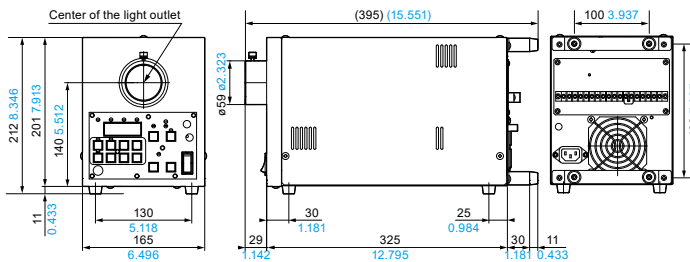

## Light guide fiber units

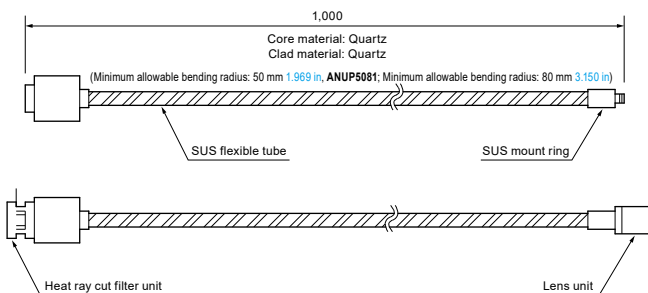

# Intensity Profiles

(Typical examples)

## Bundle diameter: ø8 mm ø0.315 in, Straight

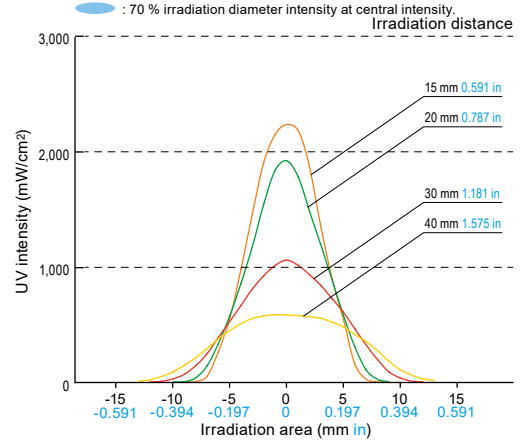
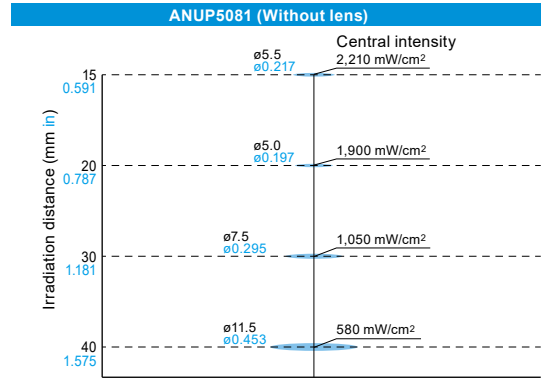

[Rough guide of the relationship between the number of fiber unit branches and the UV intensity ratio] (Irradiation distance: 15 mm 0.591 in, ø1 mm ø0.039 in sensor)

Fiber unit	UV intensity ratio	
	Without lens	With lens
ø5 × 1 branch	100 %	100 %
ø5 × 2 branches	75 %	65 %
ø5 × 3 branches	55 %	53 %
ø5 × 4 branches	50 %	45 %
ø3.5 × 1 branch	100 %	100 %
ø3.5 × 2 branches	80 %	75 %
ø3.5 × 3 branches	62 %	60 %
ø3.5 × 4 branches	57 %	50 %

External control connector (18-pin M3 screw terminal block) terminal layout

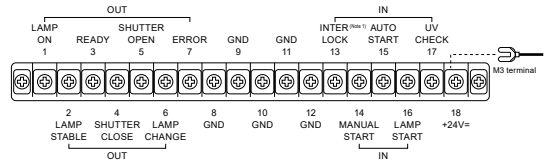

Note: At shipment, for B-contact (allows irradiation when ON), No.13 (INTERLOCK) is connected to No.12 (GND) by a short-circuit line.

## Light outlet end shape

	Fiber bundle diameter: ø5 mm ø0.197 in	Fiber bundle diameter: ø3.5 mm ø0.138 in	Fiber bundle diameter: ø8 mm ø0.315 in
Without lens	 ø10 0.394, ø14 0.551, ø19.7 0.776, ø27 1.063	 ø8 0.315, ø9 0.354, ø10.6 0.417, ø14 0.551	 ø16 0.630, ø18 0.709, ø22 0.866, ø30 0.394
For AS with lens and BS lens	 ø10 0.394, ø14 0.551, ø14 1.614	 ø8 0.315, ø9 0.354, ø14 1.614	

# Intensity Profiles (Typical examples)

## Bundle diameter: $\varnothing 5 \text{ mm } \varnothing 0.197 \text{ in}$ , Straight

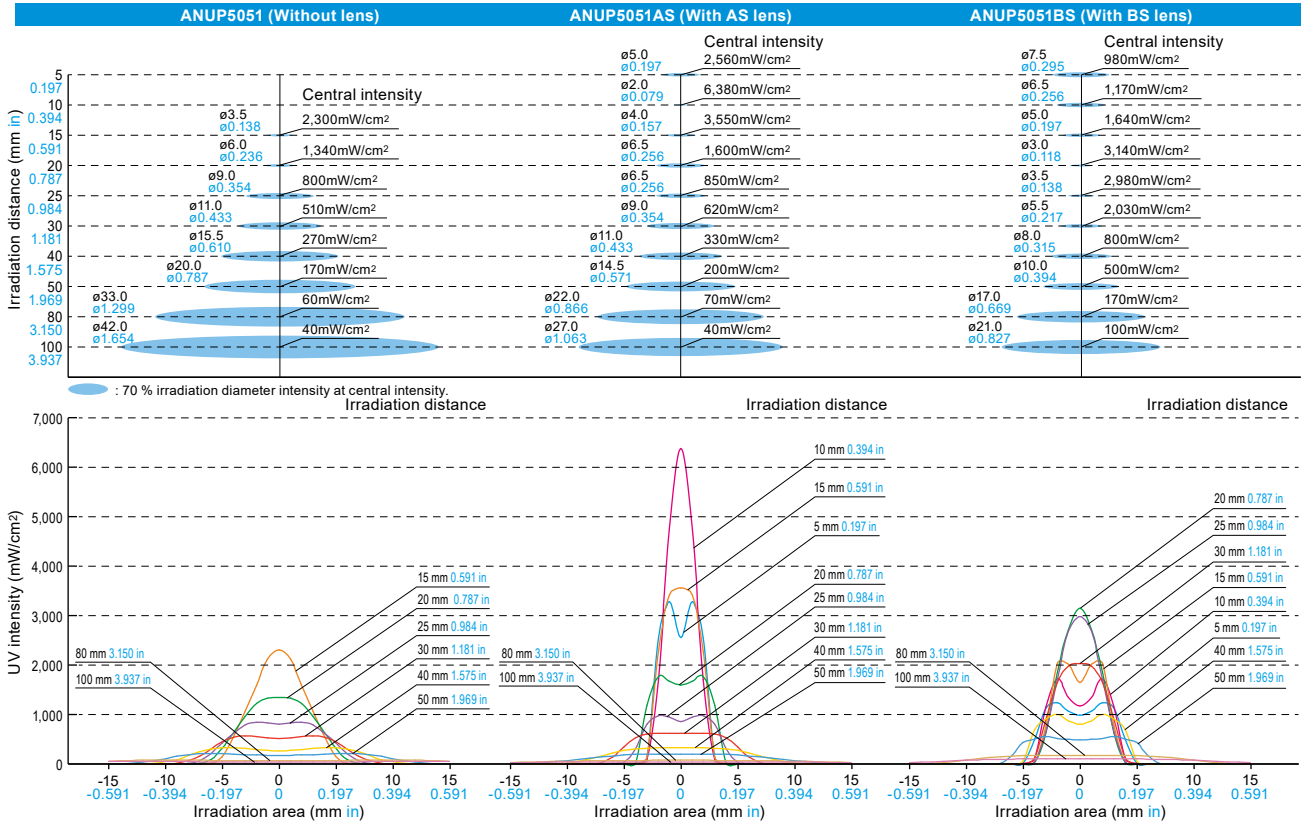

## Bundle diameter: $\varnothing 3.5 \text{ mm } \varnothing 0.138 \text{ in}$ , Straight

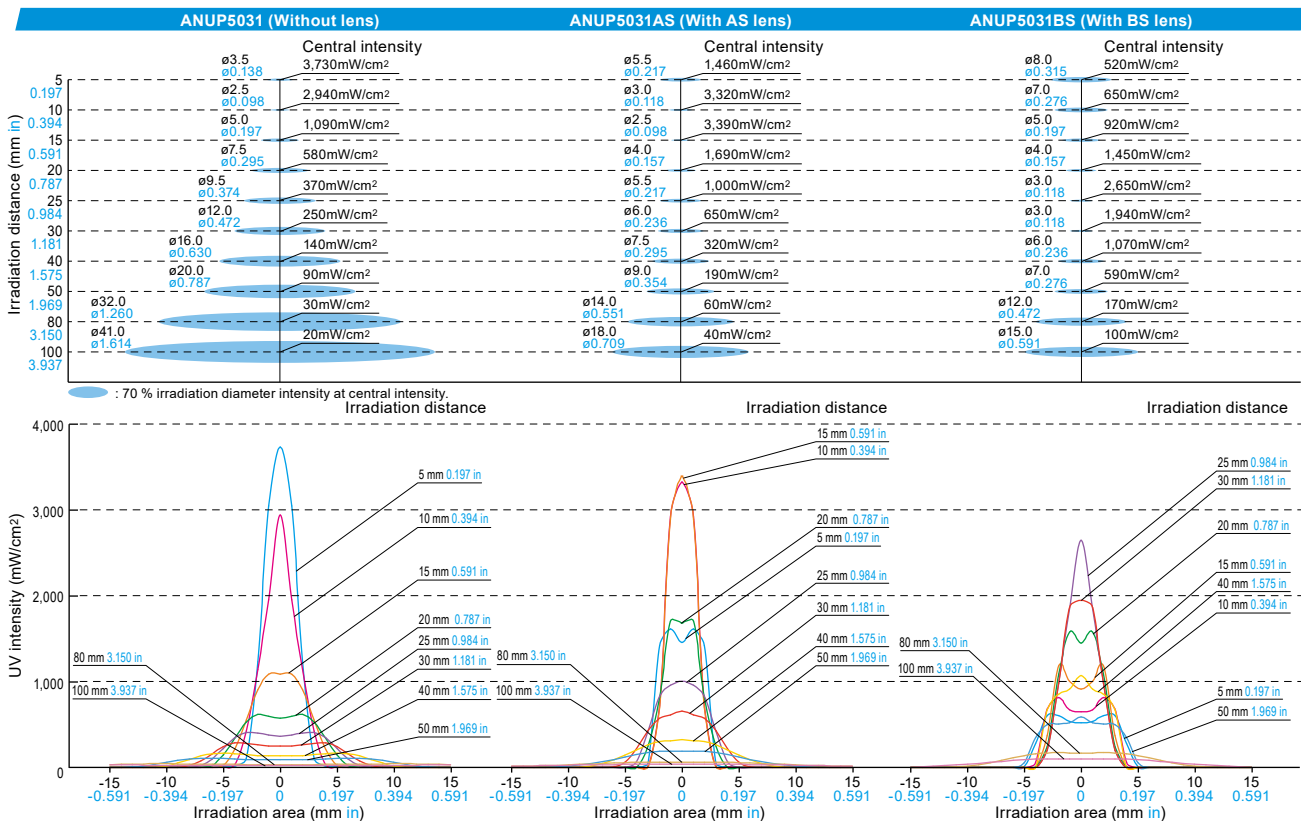

# The DICOOL optical mirror, Metal halide lamp, and UV auto control function supports customer needs.

Ideal for UV irradiation of a variety of workpieces.

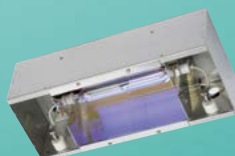

The tube types are order made to customer specifications. For more information, please consult us.

## High efficiency and high intensity

Functions for this unit has been developed based on lighting and control technologies accumulated over years, including a unique Panasonic light distribution technology (efficient irradiation) and DICOOL optical mirror, which prevents the rise of workpiece temperature. The efficient light distribution allows for high irradiation intensity, significantly enhancing productivity.

## UV auto control function for automatic compensation

Our unique UV auto control function automatically compensates for decrease in the irradiation power due to lamp deterioration over time, maintaining a stable UV irradiation until the end of the lamp life.

\*For 3 kW and 6 kW models

## DICOOL optical mirror (reflection mirror) adopted to prevent temperature rise

Our original DICOOL optical mirror which reflects UV rays only has been adopted. The DICOOL filter which transmits UV rays only can also be installed as an option. These components decrease radiant heat from the lamp and reflection mirror, reducing the workpiece temperature rise by about 40 %. This feature allows for a wider application to heat-sensitive materials. Also it is equipped with a safety system that stops UV irradiation in case of an excessive temperature rise inside the lamp housing.

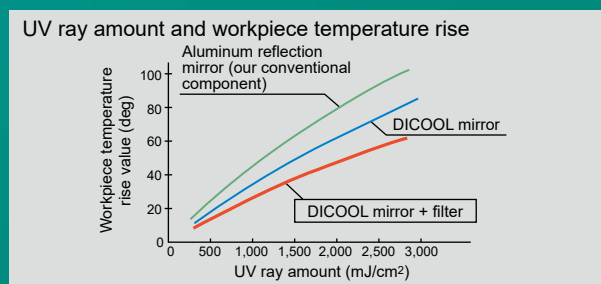
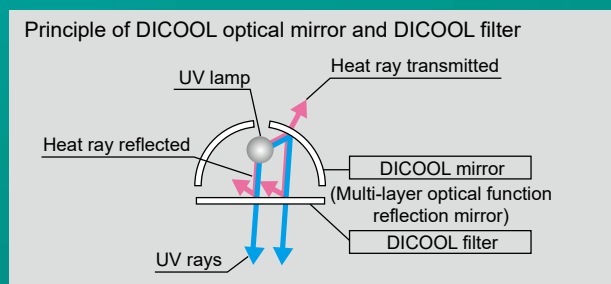

## Metal halide lamp developed to significantly increase the thick film curing speed

The metal halide lamp has high luminous efficiency at a wavelength range from 300 to 400 nm, which is about 20 % higher than the efficiency of the conventional UV lamp. This lamp is ideal for bonding, printing, marking, etc. of materials containing a color and materials that require thick film application. Also, the lamp type can be selected according to the type of UV-curable resin or coating film thickness, etc.

### Spectral energy distribution

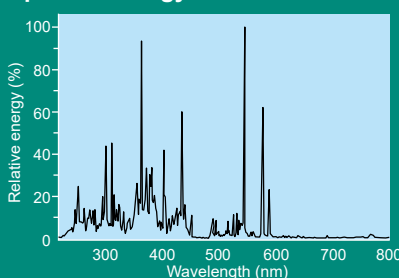

Metal halide lamp

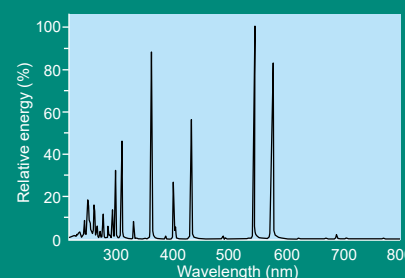

UV lamp

### Lamp lineup to cover the resin types and applications

The metal halide lamp is suited for thick-film sealing, coating, bonding, and other general purposes. The UV lamp is suited for applications that require higher surface-curing performance.



## A lamp with the best irradiation width can be chosen depending on workpiece size.

Area with 75 % peak intensity is defined as effective irradiation width. The standard effective irradiation width along the lamp width is 50 mm 1.969 in, and the effective irradiation width along the lamp length is as shown in the table below. Areas outside the effective irradiation width are also irradiated with UV rays; however, the irradiation intensity in these areas are lower.

### Irradiation width and lamp output intensity

Effective irradiation width (mm in)		Lamp output			Lamp emission length (mm in)
Along the lamp width	Along the lamp length	80 W/cm	120 W/cm	160 W/cm	
50 1.969	100 3.937		1.5 kW		125 4.921
50 1.969	150 5.906			3 kW	180 7.087
50 1.969	200 7.874			3 kW	250 9.843
50 1.969	300 11.811	3 kW		6 kW	375 14.764
50 1.969	400 15.748		6 kW		500 19.685
50 1.969	650 25.591	6 kW			750 29.528

Note: The irradiation distance is 130 mm 5.118 in (DICOOL optical mirror).

### Width along the lamp width (Workpiece flow along the lamp length)

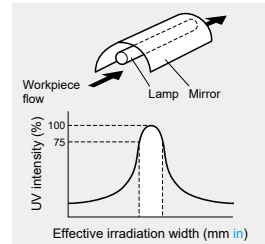

### Width along the lamp length (Workpiece flow perpendicular to the lamp length)

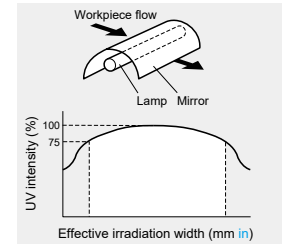

### Irradiation intensity (in the lamp width direction)

#### 50 mm 1.969 in wide type (Standard)

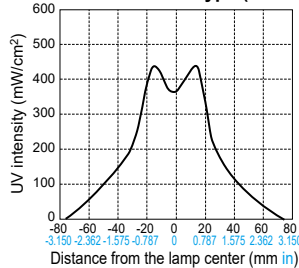

■ Lamp: Metal halide lamp (1.5 kW)  
Reflector: DICOOL optical mirror  
Distance: 130 mm 5.118 in

The 30 mm 1.181 in wide and 100 mm 3.937 in wide types are also available.

#### 30 mm 1.181 in wide type (custom-made product)

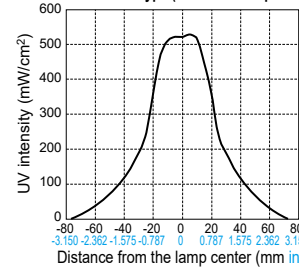

■ Lamp: Metal halide lamp (1.5 kW)  
Reflector: DICOOL optical mirror  
Distance: 130 mm 5.118 in

#### 100 mm 3.937 in wide type (custom-made product)

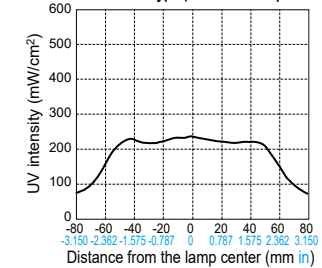

■ Lamp: Metal halide lamp (1.5 kW)  
Reflector: DICOOL optical mirror  
Distance: 130 mm 5.118 in

Note: The standard type is designed to uniformly irradiate the area of the 50 mm 1.969 in effective irradiation width.

## Power supply unit

### Function list

Capacity (kW)	Ballast type	UV intensity control function
6	Electronic ballast type (with a UV auto control function)	Continuous intensity control function
3		50 to 100 % range (in 5 % increments)
1.5	Transformer type	With a switch for dimming the intensity to 75 %

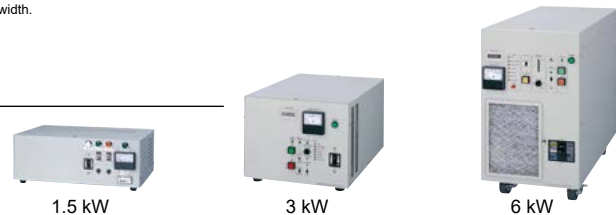

**Electronic ballast type has a smaller size and 40 % lower energy consumption**

Compared with the conventional model (6 kW), the size and weight has been significantly reduced to approx. 2/3 to 1/3. The power supply capacity has been cut by approx. 40 %, achieving significant energy conservation.

## Replacement lamps

When replacing a lamp, without fail, use one with the same lamp power and same dimensions as the one being replaced. Metal halide lamps and UV lamps of the same lamp power and same dimensions can be used to provide lighting in the same unit.

- UV-curing lamp types include a UV lamp suited for surface curing and a metal halide lamp ideal for thick-film sealing, coating, and bonding.
- You can choose from a wide selection of lamps to find the optimum type for the application.
- The average lamp life is 1,500 hours. Replace the lamp when the total lighting time reaches about 1,500 hours. (The guaranteed life is 1,000 hours.)

### ■ Lamp UV rays output retention curve

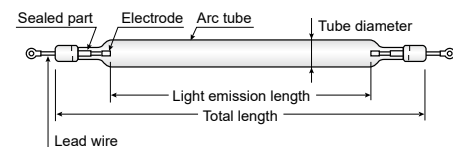
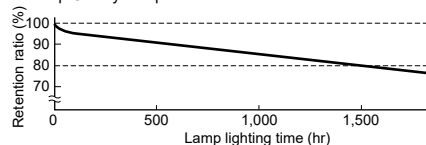

Lamp type	Part No.	Lamp power (kW)	Total length (mm in)	Emission length (mm in)	Tube diameter (mm in)	Effective irradiation width (mm in)	
						Along the lamp length	Along the lamp width
Metal halide lamp	80 W/cm type	ANUM10081	215 8.465	125 4.921	24 0.945	100 3.937	Depends on the irradiation unit
		ANUM30081	475 18.701	375 14.764	24 0.945	300 11.811	
		ANUM60081	850 33.465	750 29.528	24 0.945	650 25.591	
	120 W/cm type	ANUM15021	215 8.465	125 4.921	24 0.945	100 3.937	
		ANUM30021	350 13.780	250 9.843	24 0.945	200 7.874	
		ANUM60021	600 23.622	500 19.685	24 0.945	400 15.748	
UV lamp	80 W/cm type	ANUM30061	280 11.024	180 7.087	24 0.945	150 5.906	Depends on the irradiation unit
		ANUM60061	475 18.701	375 14.764	24 0.945	300 11.811	
		ANUPL10081	215 8.465	125 4.921	24 0.945	100 3.937	
	120 W/cm type	ANUPL20081	350 13.780	250 9.843	24 0.945	200 7.874	
		ANUPL30081	475 18.701	375 14.764	24 0.945	300 11.811	
		ANUPL60081	850 33.465	750 29.528	24 0.945	650 25.591	
160 W/cm type	ANUPL15021	215 8.465	125 4.921	24 0.945	100 3.937		
	ANUPL30021	350 13.780	250 9.843	24 0.945	200 7.874		
	ANUPL60021	600 23.622	500 19.685	24 0.945	400 15.748		
160 W/cm type	ANUPL30061	280 11.024	180 7.087	24 0.945	150 5.906	Depends on the irradiation unit	
	ANUPL60061	475 18.701	375 14.764	24 0.945	300 11.811		
	ANUPL60061	475 18.701	375 14.764	24 0.945	300 11.811		

Note: The effective irradiation width refers to the irradiation width when the light intensity is approx. 75 % of the peak intensity. The standard effective irradiation width along the lamp width is 50 mm 1.969 in. Areas outside the effective irradiation width are also irradiated with UV rays; however, the irradiation intensity in such areas is lower, taking longer to complete the curing process.

### Precautions for lamp handling

- The arc tube is heated (+700 to +800 °C +1,292 to +1,472 °F) during the lamp lighting. If the arc tube makes contact with a foreign substance or the user's bare hands, the dirt can cause the tube to lose its clarity, decreasing the lamp efficiency. When setting up the lamp, wipe the lamp with alcohol.
- Lighting the lamp alone will overheat and shorten the lamp life. Make sure to use a UV irradiation unit designed by our company and cool the lamp.

# ANUP8000 Series

## Wide selection of 1.5 kW, 3 kW, and 6 kW type helps select best option for your production equipment.

- The 3 kW and 6 kW types adopt an electronic ballast (with a UV auto control function). The 1.5 kW types adopt a transformer system.
- The lamp housing and the power supply unit can be easily connected by metal connectors.
- The lamp switch automatically runs and stops the lamp cooling fan by timer control.
- The system has a lamp voltmeter and an hour meter.

### Power supply unit specifications

Lamp output		1.5 kW	3 kW	6 kW
Ballast type		Transformer	Electronic ballast	
Input power supply		Single phase 200 V AC 50 / 60 Hz (Toggle switch selectable) 15 A	Single phase 200 / 220 / 240V AC 50 / 60Hz 30A	Three phase 200V AC 50 / 60Hz 30A
Lamp	Metal halide lamp	1.5 kW	3 kW	6 kW
	UV lamp			
External output signals (Monitor function)		Shutter open/close confirmation (available in the type with the shutter function) and temperature thermal normal	Detection of lamp-on, lamp stabilized, errors and cooling fan operation (6 kW type only)	
External input signals (Remote control function)		Shutter open / close (available in the type with the shutter function)	Lamp-ON / OFF, lamp output switching, interlock and shutter open / close (available in the type with the shutter function)	
Error monitor displays		Lamp housing temperature errors and lamp cooling fan errors	Lamp errors, lamp error output power supply unit errors, lamp housing temperature errors, lamp cooling fan errors and interlock	
Lamp intensity control		With a switch for dimming the intensity to 75 %	Adjustable range: 100 to 50 %	
Auto control function (UV intensity retention function)		—	Equipped, adjustable range:100 to 50 %	Equipped, adjustable range:100 to 65 %
Power supply unit size (mm in)		L: 450 × W: 310 × H: 175 L: 17.717 × W: 12.205 × H: 6.890	L: 340 × W: 450 × H: 247 L: 13.386 × W: 17.717 × H: 9.724	L: 270 × W: 685 × H: 475 L: 10.630 × W: 26.968 × H: 18.701
Weight		32 kg approx.	28 kg approx.	45 kg approx.



### Main base part number specifications

Part No.	Lamp output	Lamp output intensity	Effective irradiation width (width along the lamp width)
<b>ANUP8154</b>	1.5 kW	120 W/cm	100 mm <a href="#">3.937 in</a>
<b>ANUP8304E</b>	3 kW	80 W/cm	300 mm <a href="#">11.811 in</a>
<b>ANUP8308E</b>	3 kW	120 W/cm	200 mm <a href="#">7.874 in</a>
<b>ANUP8368E</b>	3 kW	160 W/cm	150 mm <a href="#">5.906 in</a>
<b>ANUP8604DE</b>	6 kW	80 W/cm	650 mm <a href="#">25.591 in</a>
<b>ANUP8608DE</b>	6 kW	120 W/cm	400 mm <a href="#">15.748 in</a>
<b>ANUP8668DE</b>	6 kW	160 W/cm	300 mm <a href="#">11.811 in</a>



Fan (for 6 kW)

- Notes: 1) Lamp type: Metal halide lamp  
 2) For UV lamp type, shutter, DICOOL filter, aluminum reflector type and other specifications, please consult us.  
 3) Except for some part numbers, **ANUP8000** series products are delivered according to customer specifications. The part number will be presented when a quotation is issued.  
 4) All tube type products are order made to customer specifications. The part number will be presented when a quotation is issued.

## ANUP8000 Series (Standard type)

Tube type standard model Easy to install and set up.

### Specifications (ANUP8308E)

(Metal halide lamp: 3 kW 120 W/cm type, base part number)

Power supply	Single phase 200 V (50 / 60 Hz), 30 A
UV lamp	3 kW x 1 lamp (Metal halide lamp)
Effective irradiation width (width along the lamp width)	200 mm <a href="#">7.874 in</a>
System size (mm in)	L: 548 × W: 212 × H: 383 L: <a href="#">21.575</a> × W: <a href="#">8.346</a> × H: <a href="#">15.079</a> (Lamp housing)
	L: 340 × W: 450 × H: 247 L: <a href="#">13.386</a> × W: <a href="#">17.717</a> × H: <a href="#">9.724</a> (Power supply unit)
System weight	Lamp housing: 15 kg approx., Power supply unit: 28 kg approx.



Lamp housing



Power supply unit

- Notes: 1) For UV lamp type, shutter, DICOOL filter, aluminum reflector type and other specifications, please consult us.  
 2) The 6 kW types are also available.

## ANUP3000 Series (Bench top type)

The power supply unit is separate, and the system can be placed on the same rack as other peripheral equipment, allowing for easy setup of the system

The tube type products are order made to customer specifications. For more information about the conveyor unit or other details, please consult us.

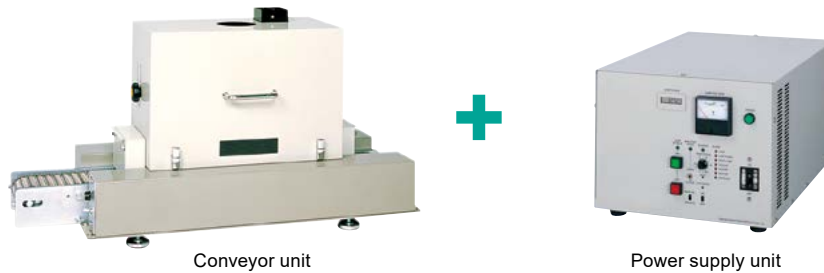

Note: Conveyor unit varies in appearance according to the lamp specification.

## ANUP7000 Series (Standalone type)

General-purpose type that supports a wide variety of workpieces, including electronic components and PC boards

### Specifications (ANUP7328E) (Metal halide lamp: 3 kW 120 W/cm type, base part number)

Power supply	Single phase 200 V (50 / 60 Hz), 30 A
UV lamp	3 kW × 1 lamp (Metal halide lamp, 120 W/cm)
Conveyor speed	0.5 to 5 m/min.
Conveyor belt	Stainless steel mesh belt
Conveyable workpiece size	W: 300 × H: 100 mm W: 11.811 × H: 3.937 in
Conveyor height	750 ±25 mm 29.528 ±0.984 in
Effective irradiation width	200 mm 7.874 in
System size	L: 1,200 × W: 536 × H: 1,156 mm L: 47.244 × W: 21.102 × H: 45.512 in
System weight	110 kg approx.

Note: For UV lamp type, conveyor size, shutter, DICOOL filter, heat-resistant resin belt, aluminum reflector type and other specifications, please consult us.

- The intensity can be adjusted to a range from 50 to 100 % in increments of 5 %.
- Ideal for workpieces of 300 mm 11.811 in or less in width and an irradiation width of 200 mm 7.874 in or less.
- The lamp height can be easily adjusted according to the workpiece height.
- The lightweight compact design facilitates in-line installation with other equipment.



Standalone type

## Customization options

We can also offer products using 1.5 kW, 3 kW and 6 kW type power supply units and lamps according to your requirements of the irradiation area and energy. In addition, the following specification options are also available. Please consult us for details.

1. Changing the belt to a heat-resistant resin belt
2. Changing the belt conveyor width and/or length
3. With shutter type
4. Change to irradiation width 30mm or 100 mm  
1.181 in or 3.937 in
5. Decreasing the irradiation unit temperature (Adding a DICOOL filter)
6. Change to aluminum reflector
7. Adding a conveyor speed display
8. Making a conveyor-equipped type based on ANUP8000 Series
9. The irradiation unit position can be customized to be, for example, perpendicular or parallel with respect to the workpiece flow direction if necessary.

# UV irradiation intensity of 10,000 mW/cm<sup>2</sup> class at irradiation distance 30 mm 1.181 in. High power output LED Line Type UV curing system

1,050 mm type head production sample  
(L: 1,225 × W: 210 × H: 110 mm L: 48.228 × W: 8.268 × H: 4.331 in)  
Excl. wiring connections and protruding sections



## Specifications

Effective irradiation width	Min. 70 to 1,800 mm 2.756 to 70.866 in (* For more detailed specifications, please consult us.)
UV irradiation intensity	9,600 mW/cm <sup>2</sup> can be supplied (at surface 30 mm 1.181 in below the irradiation section )
Irradiation distance	30 mm 1.181 in, 80 mm 3.150 in (types with standard mounts for printing machines) *For different specifications, please consult us.
UV wavelength (Central wavelength)	385 nm, 365 nm
Estimated light source life	15, 000 hours approx. (* The value is not a guaranteed value.)
Controller size	L: 500 × W: 300 × H: 710 mm L: 19.685 × W: 11.811 × H: 27.953 in (Depending on the irradiation specification, more than two units will be required.)
UV irradiation unit cooling system	Forced water cooling system (please make your own arrangements for chillers, etc.) * Clear water (or tap water) cooling can also be used.



Power supply and controller unit  
( L: 500 × W: 300 × H: 710 mm  
L: 19.685 × W: 11.811 × H: 27.953 in )  
Excl. wiring connections and protruding sections

Please contact:

## Panasonic Industrial Devices SUNX Co., Ltd.

2431-1 Ushiyama-cho, Kasugai-shi, Aichi, 486-0901, Japan  
Global Sales Department  
■Telephone: +81-568-33-7861 ■Facsimile: +81-568-33-8591  
[panasonic.net/id/pidsx/global](http://panasonic.net/id/pidsx/global)

**Panasonic**<sup>®</sup>