



4D SYSTEMS

TURNING TECHNOLOGY INTO ART

MOTG

Modules On The Go Series

MOTG-WiFi-ESP

MOTG-MP3

MOTG-RS232

MOTG-RS485

MOTG-BLUETOOTH

Gen4-MOTG-AC1

Gen4-MOTG-AC2

Gen4-MOTG-AC3

MOTG-BREADTOOTH

Document Date: 22nd March 2017

Document Revision: 1.0

MOTG Introduction	6
Universal MOTG Interface (UMI)	6
Pin Description	6
Board Dimension	7
Hardware Support	7
MOTG-BREADTOOTH	7
gen4-MOTG-AC1	8
gen4-MOTG-AC2	8
gen4-MOTG-AC3	8
Software Support	9
1. MOTG-WiFi-ESP	9
1.1. Description	9
1.2. Features.....	9
1.3. Before Getting Started	9
1.4. Chipset Features.....	10
1.4.1. The ESP8266 Wi-Fi Module	10
1.5. Pins, Buttons and Solder Bridges	10
1.5.1. Pin Description	10
1.5.2. Button Description	10
1.5.3. Solder Bridge Description.....	10
1.6. Firmware Programming	11
1.7. Mechanical Views.....	14
1.8. Schematic Details	15
1.9. Specifications	16
1.10. Hardware Revision History.....	17
2. MOTG-MP3	18
2.1. Description	18
2.2. Features.....	18
2.3. Before Getting Started	18
2.4. Pin and Solder Bridges	19
2.4.1. Pin Description	19
2.4.2. Solder Bridge Description.....	19
2.5. Serial Commands.....	20
2.6. Media – micro-SD card.....	23

2.7. File & Folder Structure	23
2.8. Mechanical Views.....	24
2.9. Schematic Details	25
2.10. Specifications	26
2.11. Hardware Revision History.....	27
3. MOTG-RS232.....	28
3.1. Description	28
3.2. Features.....	28
3.3. Before Getting Started	28
3.4. Chipset Features.....	28
3.5. Pins and Solder Bridges	29
3.5.1. Pin Description	29
3.5.2. Solder Bridge Description.....	29
3.6. Mechanical Views.....	30
3.7. Schematic Details	31
3.8. Specifications	32
3.9. Hardware Revision History.....	33
4. MOTG-RS485.....	34
4.1. Description	34
4.2. Features.....	34
4.3. Before Getting Started	34
4.4. Chipset Features.....	34
4.5. Pins and Solder Bridges	35
4.5.1. Pin Description	35
4.5.2. Solder Bridge Description.....	35
4.6. Mechanical Views.....	36
4.7. Schematic Details	37
4.8. Specifications	38
4.9. Hardware Revision History.....	39
5. MOTG-BLUETOOTH	40
5.1. Description	40
5.2. Features.....	40
5.3. Before Getting Started	40
5.4. Chipset Features.....	40
5.4.1. The RN4870 Bluetooth Module.....	40

5.5. Pins and Solder Bridges	41
5.5.1. Pin Description	41
5.5.2. Solder Bridge Description.....	41
5.6. Firmware Programming	42
5.7. Mechanical Views.....	48
5.8. Schematic Details	49
5.9. Specifications	50
5.10. Hardware Revision History.....	51
6. gen4-MOTG-AC1.....	52
6.1. Description	52
6.2. Hardware Overview	52
6.3. Pin Description	52
6.4. Accessing pins of MOTG via gen4-PA.....	53
6.5. Mechanical Views.....	54
6.6. Schematic Details	55
6.7. Hardware Revision History.....	56
7. gen4-MOTG-AC2	57
7.1. Description	57
7.2. Hardware Overview	57
7.3. Pin Description	57
7.3.1. MOTG Slot #1 Pin Description	57
7.3.2. MOTG Slot #2 Pin Description	58
7.4. Communication	58
7.4.1. UART	58
7.4.2. SPI	58
7.4.3. I2C.....	58
7.5. Accessing MOTG pins via gen4-PA.....	59
7.6. Mechanical Views.....	60
7.7. Schematic Details	61
7.8. Specifications	62
7.9. Hardware Revision History.....	63
8. gen4-MOTG-AC3	64
8.1. Description	64
8.2. Hardware Overview	64
8.3. Pin Description	64

8.4. Accessing pins of MOTG via gen4-PA.....	65
8.5. Mechanical Views.....	66
8.6. Schematic Details	67
8.7. Specifications	68
8.8. Hardware Revision History.....	69
9. MOTG-BREADTOOTH.....	70
9.1. Description	70
9.2. Hardware Overview	70
9.3. Pin Description	70
9.4. Mechanical Views.....	71
9.5. Schematic Details	72
9.6. Hardware Revision History.....	73
10. Legal Notice.....	74
11. Contact Information	74

Board Dimension

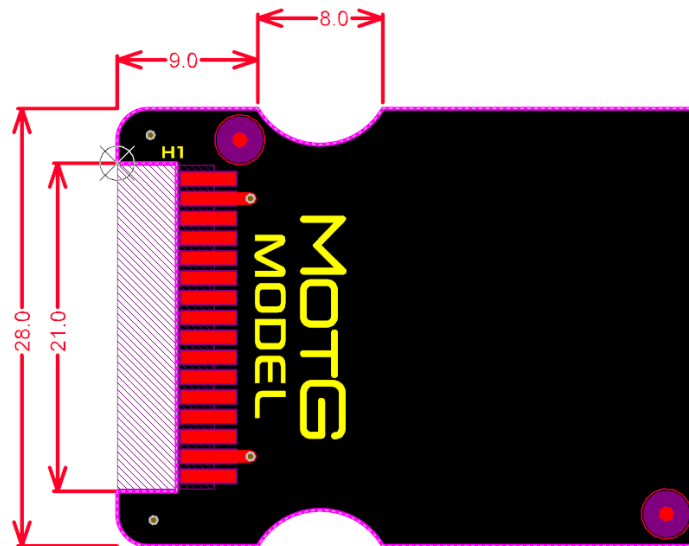

The MOTG boards are designed in such a way that the leading edge (header end) of the MOTG modules is a fixed design, and depending how complex the MOTG module is, will determine how long the board itself is. By default, the standard MOTG module is around 37mm in length, but can be extended longer if required. Note that depending on the target application, longer boards may have mounting challenges.

Created by 4D Systems, UMI is an open standard – anyone can implement UMI in their hardware design provided the requirements for UMI are met.

Hardware Support

Improving the experience with MOTG modules, 4D Systems provides interface boards enabling easy connectivity to popular host controllers such as gen4 modules, Arduino, Raspberry PI and Beaglebone Black.

MOTG-BREADTOOTH

The MOTG-BREADTOOTH breaks out the UMI pins of the MOTG. It is compatible with all MOTG modules and is a quick and easy way to make your MOTG module breadboard-friendly. The MOTG-BREADTOOTH permits the MOTG to be interfaced to a breadboard for prototyping and for interfacing to virtually any host.

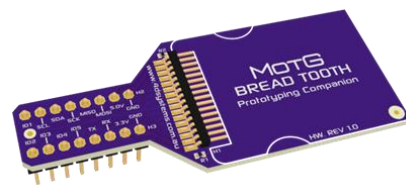

gen4-MOTG-AC1

The gen4-MOTG-AC1 Interface Board allows easy interface of a MOTG module to Diablo16-based gen4 display modules. The board carries one UMI-compatible MOTG slot which acts as an extension to the display module providing plug-and-play interface with MOTG.

The interface board is designed to sit flush on the back of the Diablo16 2.4" to 3.5" display modules enabling sleek and compact designs. For more information, refer to section 6 of this datasheet.

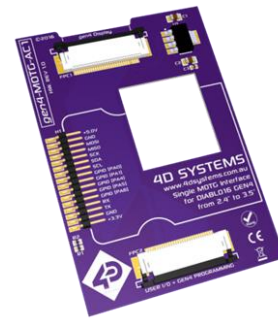

gen4-MOTG-AC2

The gen4-MOTG-AC2 Interface Board allows easy interface of a MOTG module to Diablo16-based gen4 display modules. The board carries two UMI-compatible MOTG slots which act as an extension to the display module providing plug-and-play interface with MOTG.

The interface board is designed to sit flush on the back of the Diablo16 3.2" and 3.5" display modules enabling sleek and compact designs. For more information, refer to section 7 of this datasheet.



gen4-MOTG-AC3

The gen4-MOTG-AC3 Interface Board allows easy interface of a MOTG module to Picaso-based gen4 display modules. The board carries one UMI-compatible MOTG slot which acts as an extension to the display module providing plug-and-play interface with MOTG.

The interface board is designed to sit flush on the back of the Picaso 2.4" to 3.2" display modules enabling sleek and compact designs. For more information, refer to section 8 of this datasheet.

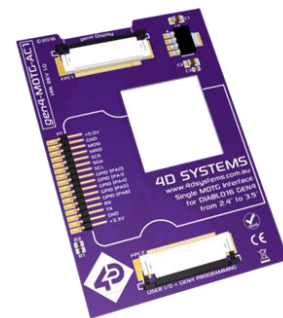

Software Support

4D Systems also provides extensive software support allowing designers to get started easily with popular host controller platforms. In addition, projects, application notes and code base examples utilising MOTG modules are available at www.4dsystems.com.au

1. MOTG-WiFi-ESP



1.1. Description

MOTG-WiFi-ESP provides a low-cost solution for all embedded wireless applications. It features an ESP8266 Wi-Fi SoC, a leading platform for Wi-Fi related projects or Internet of Things (IoT).

The MOTG-WiFi-ESP supports APSD for VoIP applications and Bluetooth co-existence interface. It contains a self-calibrated RF allowing it to work under all operating conditions.

1.2. Features

- ESP8266 Wi-Fi Module by Espressif with
 - 802.11 b/g/n
 - Wi-Fi Direct (P2P), soft-AP
 - TCP/IP protocol stack
 - 1MB Flash
- 3.3V Power supply only
- Supports 2-Wire 3.3V TTL UART interface
- On board Reset and Flash Buttons
- On board PCB trace antenna

1.3. Before Getting Started

Out of the box, the chipset's UART pins are not connected to the UMI of the MOTG.

MOTG-WiFi-ESP hardware allows the UART pins to be connected to either TX, RX or GPIO1, GPIO2 of the UMI. This is could be achieved by shorting the respective sides of solder bridges SB1 and SB2, using a solder blob and a soldering iron. This must be done by the User.

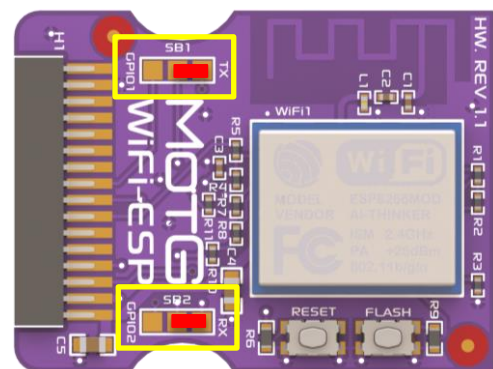

Unless the designer intends to use 2 UART MOTGs on a gen4-MOTG-AC2 board, the UART pins should be directed to TX, RX of the UMI as shown above.

When two UART MOTGs are being used on a gen4-MOTG-AC2 board, the UART pins of one of the MOTGs should be diverted to GPIO1 and GPIO2 of the UMI, as shown below. This prevents both MOTGs from utilising the same pins of the gen4 display module for UART communication.

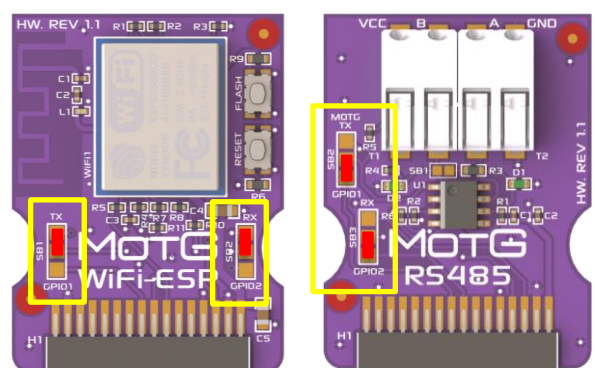

1.4. Chipset Features

1.4.1. The ESP8266 Wi-Fi Module



The ESP8266 Wi-Fi SoC is a leading platform for Wi-Fi related projects or Internet of Things (IoT).

The ESP8266 supports APSD for VoIP applications and Bluetooth co-existence interfaces, it contains a self-calibrated RF allowing it to work under all operating conditions.

There is an almost limitless fountain of information available for the ESP8266, all of which has been provided by amazing community support.

By default, the MOTG-WiFi-ESP module comes with the AT Command set, so no programming of the WiFi module's firmware is required to get it running.

The data sheet for the ESP8266 is available from the <https://espressif.com> website.

1.5. Pins, Buttons and Solder Bridges

1.5.1. Pin Description

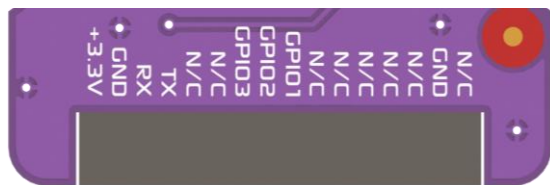

Pin	Symbol	Description
1	3.3V	3.3V Input Supply
2	GND	Supply Ground
3	RX	Asynchronous Serial Receive Pin
4	TX	Asynchronous Serial Transmit Pin
5	N/C	No Connect
6	N/C	No Connect
7	GPIO3	Reset pin. An active Low pulse will reset the module
8	GPIO2	RX Bypass
9	GPIO1	TX Bypass
10	N/C	No Connect
11	N/C	No Connect
12	N/C	No Connect

13	N/C	No Connect
14	N/C	No Connect
15	GND	Supply Ground
16	N/C	No Connect

Note:

Designer can choose if the UART pins of the MOTG should be connected to either TX, RX or GPIO1, GPIO2 of the UMI. This is could be achieved by shorting the respective sides of solder bridges SB1 and SB2. This is discussed in detail in 1.3. Before Getting Started.

1.5.2. Button Description

The MOTG-WiFi-ESP also has two buttons, the functionalities of which are described in the table below.

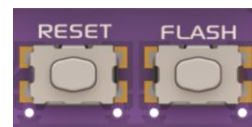

Button	Description
Reset	Resets the ESP8266 module
Flash	Used along with Reset button to update/change firmware on ESP8266

The Flash button, when held down and the reset button pressed, puts the ESP8266 WiFi processor into its bootloader mode. This is required when flashing the ESP8266 with an updated or alternative firmware.

1.5.3. Solder Bridge Description

The MOTG-WiFi-ESP also has two solder bridges. The functionality of these solder bridges is described in the table below. These are soldered by the User.

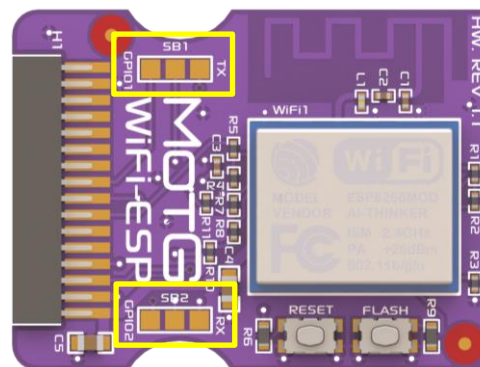

Solder Bridge	Description
SB1	TX Selector
SB2	RX Selector

1.6. Firmware Programming

The MOTG-WiFi-ESP comes preprogrammed with the AT command set firmware. If an updated command set is desired, or if another program is to be loaded on to the ESP8266 instead, then the default AT command set will be lost.

The following procedure outlines how to reload the ESP8266 with the AT command set.

Please download the AT command set files from the MOTG-WiFi-ESP product page on the 4D Systems website.

Extract the files to a known location on your hard drive that is easy to access.

Run the application:
ESPFlashDownloadTool_v3.3.4.exe

The application window will appear.

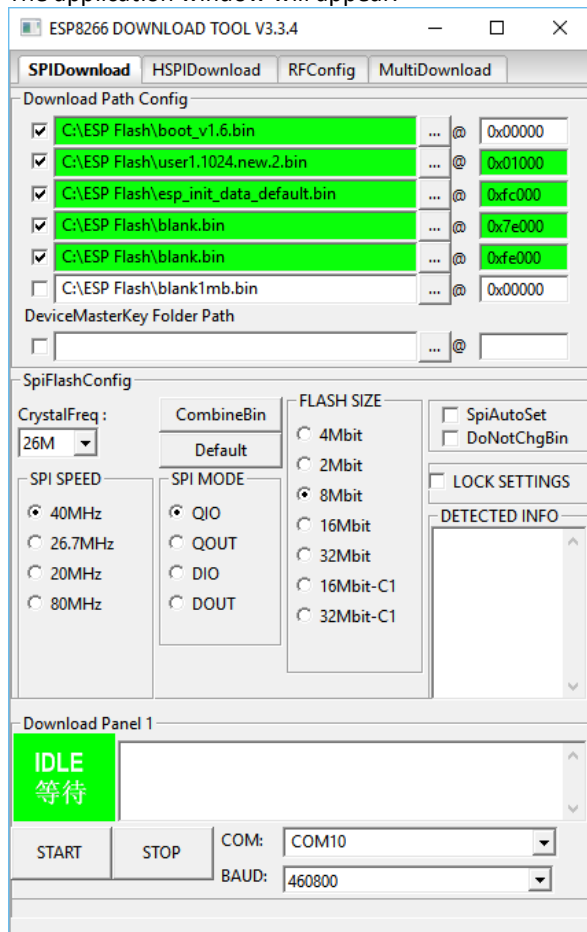

It will be noticed there are 6 different files preloaded into the Download Path Config boxes. These need to be changed to the location where the files were extracted to.

Click the [...] mark and locate the path to the file it is referring to.

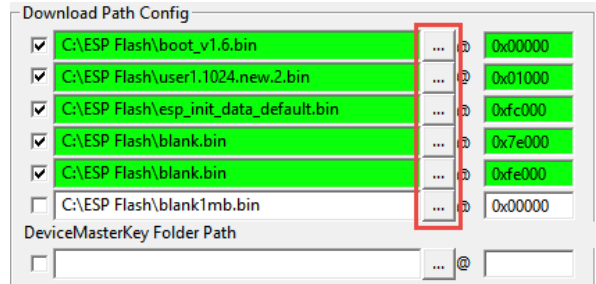

The lines will be highlighted if the files are found.

Ensure that the addresses are correct as per the picture and set to the following:

- boot_v1.6.bin – **ADDR 0x0000**
- user1.1024.new.2.bin – **ADDR 0x01000**
- esp_init_data_default.bin – **ADDR 0xfc000**
- blank.bin – **ADDR 0x7e000**
- blank.bin – **ADDR 0xfe000**
- blank1mb.bin – **ADDR 0x00000**

All the files are located in the root folder of that zip you just extracted, next to the ESPFlashDownloadTool_v3.3.4.exe file.

The following 5 pins of the MOTG-WiFi-ESP will be used when uploading a firmware. TX, RX sides of the SB1 and SB2 should be shorted for the following procedure.

- +3.3V (not 5V tolerant)
- GND
- RX
- TX
- GPIO3 (Reset)

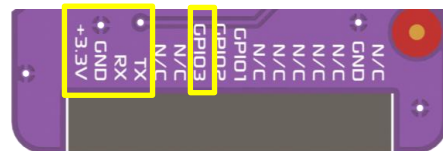

In this case, a gen4-MOTG-AC1 is used to gain access to the above 5 pins of the MOTG-WiFi-ESP. However, other gen4-MOTG-AC interface boards provided by 4D Systems could be used as well. The gen4-MOTG-AC1 is then interfaced to the gen4-PA, which essentially serves as a breakout board for the UMI pins in this setup.

Note: If you opt to use a MOTG-BREADTOOTH instead of the gen4-MOTG-AC1 + gen4-PA combo, the 5V supply needs to be dropped to 3.3V externally, as MOTG-BREADTOOTH does not facilitate this internally.

Lastly, a programming module is needed to program the MOTG-WiFi-ESP through the gen4-MOTG-AC1 + gen4-PA combo. This process does not necessarily require a 4D Systems programming module - the 4D USB programming cable or the uUSB-PA5. However these are compatible and could be used to perform this procedure.

Carefully slide the MOTG-WiFi-ESP on to the gen4-MOTG-AC1. Then connect the gen4-MOTG-AC1 to the gen4-PA using a 30-way FFC cable. Then connect the 4D programming module to the corresponding pins of the gen4-PA as shown in the image below.

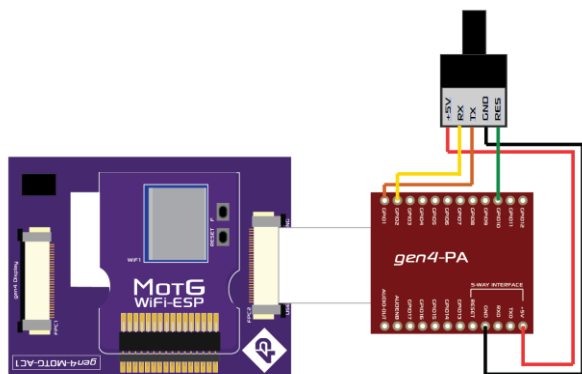

MOTG-WiFi-ESP	gen4-PA	4D programming cable
	+5V	5V
GND	GND	GND
RX	GPIO1	TX
TX	GPIO2	RX
GPIO3 (Reset)	GPIO10	RES

Then check the com port of the programmer you are using and change it accordingly in the application.

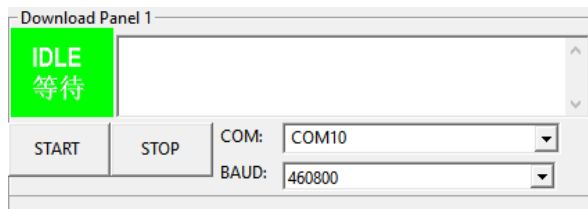

Before anything is programmed, the ESP8266 module needs to be wiped blank. It is always best to do this before programming in any new firmware, as residual data can be left which can cause unexpected results.

To wipe the ESP8266 blank, untick all the files in the Download Path Config section, except for blank1mb.bin – **ADDR 0x0000** (the last file)

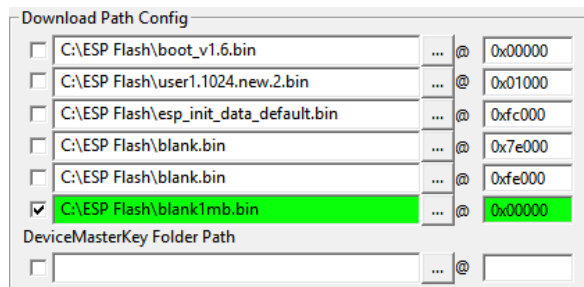

Now the ESP8266 needs to be placed into bootloader mode. To do this, simply press and hold the Flash button on the MOTG-WiFi-ESP, and press the Reset button for a second and then release the Reset button. Keep holding the Flash button. A second or so later, you can release the Flash button. The ESP8266 should now be in bootloader mode.

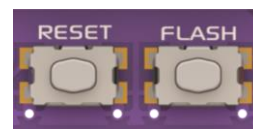

Press the Start Button, to start the programming of the ESP8266 module.

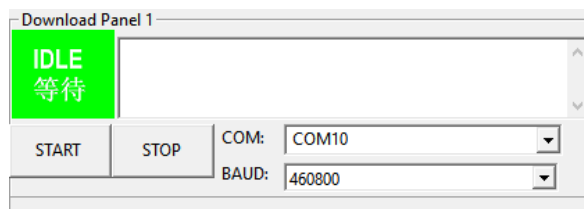

After clicking the START button the application will SYNC as shown below.

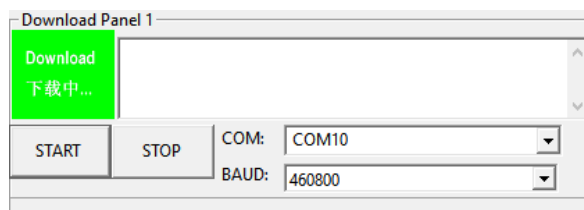

Then the application will load and the ESP8266 is wiped blank. It will complete when the progress bar goes to the very right hand side.

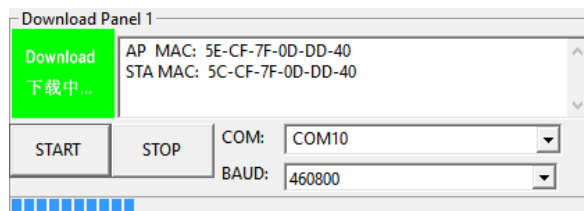

If the initiation was not successful, the loading will fail. If failed, try the procedure again till it loads.

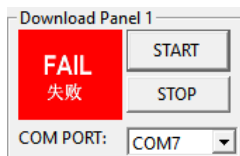

Now the module is ready to be programmed with the firmware. This procedure is almost same as earlier.

Tick all the files except for blank1mb.bin – **ADDR 0x0000** (the only difference in the procedure compared to before).

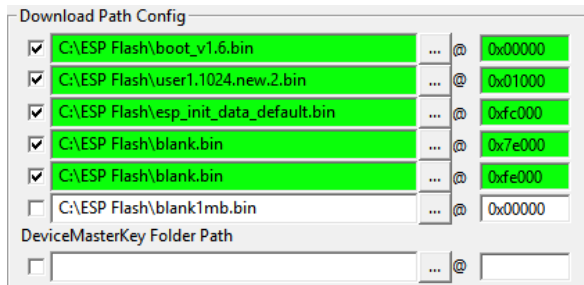

Again, the ESP8266 needs to be placed into bootloader mode. To do this, simply press and hold the Flash button on the MOTG-WiFi-ESP, and press the Reset button for a second and then release the Reset button. Keep holding the Flash button. A second or so later, you can release the Flash button. The ESP8266 should now be in bootloader mode.

Press the Start Button, to start the programming of the ESP8266 module. When the progress bar goes to the very right hand side, the process is complete, and the module should have been successfully loaded with the AT command set.

1.7. Mechanical Views

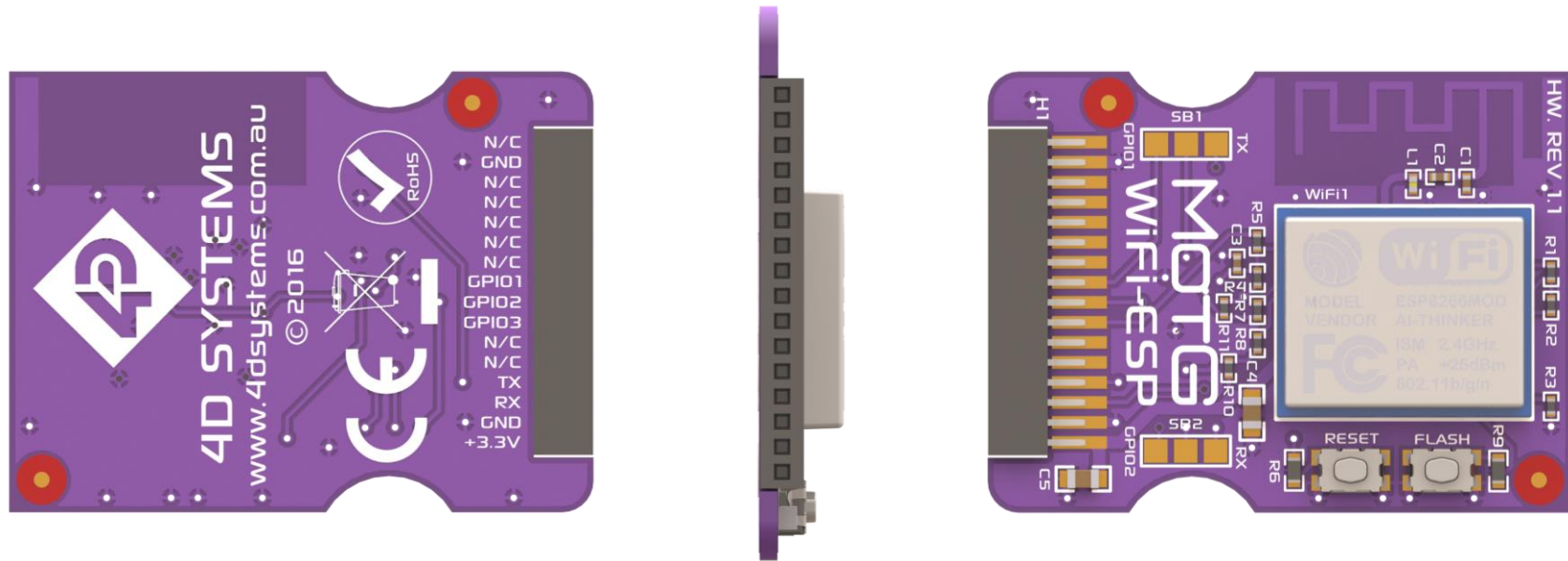

1.8. Schematic Details

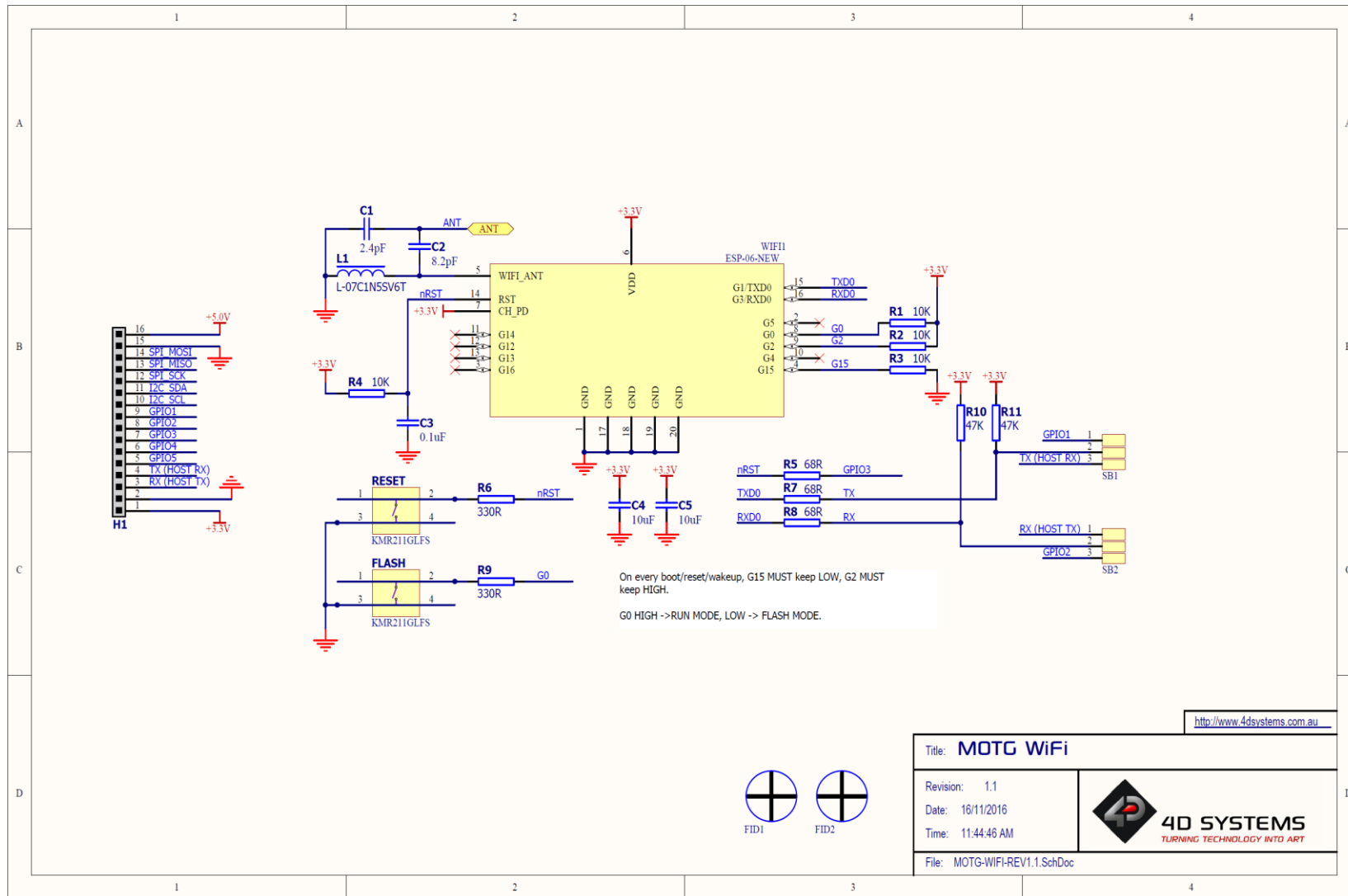

1.9. Specifications

RECOMMENDED OPERATING CONDITIONS

Parameter	Conditions	Min	Typ	Max	Units
Supply Voltage (VCC)		1.7	3.3	3.6	V
Operating Temperature		-20	--	70	°C
Input Low Voltage (VIL)	All pins	-0.3	--	0.25*VCC	V
Input High Voltage (VIH)	All pins	0.75*VCC	--	3.6	V

GLOBAL CHARACTERISTICS BASED ON OPERATING CONDITIONS

Parameter	Conditions	Min	Typ	Max	Units
Supply Current (ICC)		--	215.0	--	mA
Output Low Voltage (VOL)		-0.3	--	0.1*VCC	V
Output High Voltage (VOH)		0.8*VCC	--	VCC	V

2. MOTG-MP3

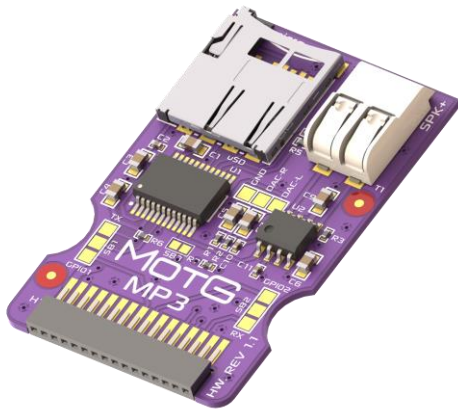

2.1. Description

MOTG-MP3 is an audio sound module that can play MP3 audio files stored on a micro-SD card, such as voice and music.

The MOTG-MP3 features an on board 16bit MCU, specifically designed for hardware audio decoding by 4D Systems.

It features an on-board mono amplifier capable of driving a 4-ohm 3-watt speaker. It also features stereo DAC output for connecting directly to headphones or to an external amplifier.

In short, the MOTG-MP3 offers very flexible, compact and low cost embedded audio solution for many applications.

2.2. Features

- Features SOMO II 16 bit MCU by 4D Systems
- Supports 5V power supply only
- Supports bit rates 11172-3 & ISO1381303
- Sample rates from 8Khz to 48Khz
- 24-bit DAC audio output
- Supports 2-Wire 3.3V TTL UART interface
- Mono amplified Speaker output
- On-board micro-SD memory card connector

2.3. Before Getting Started

Out of the box, the chipset's UART pins are not connected to the UMI of the MOTG.

MOTG-MP3 hardware allows the UART pins to be connected to either TX, RX or GPIO1, GPIO2 of the UMI. This is could be achieved by shorting the respective sides of solder bridges SB1 and SB2 with a blob of solder, using a soldering iron. This must be done by the User.

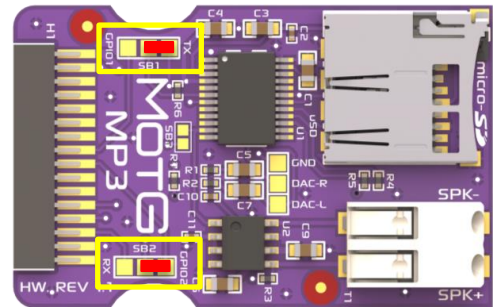

Unless the designer intends to use 2 UART MOTGs on a gen4-MOTG-AC2 board, the UART pins should be directed to TX, RX of the UMI as shown above.

When two UART MOTGs are being used on a gen4-MOTG-AC2 board, the UART pins of one of the MOTGs should be diverted to GPIO1 and GPIO2 of the UMI, as shown below. This prevents both MOTGs from utilising the same pins of the gen4 display module for UART communication.

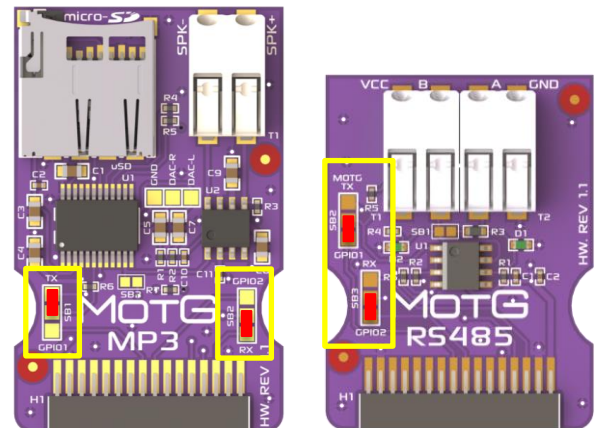

2.4. Pin and Solder Bridges

2.4.1. Pin Description

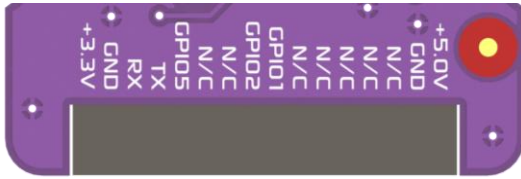

Pin	Symbol	Description
1	3.3V	No Connect
2	GND	Supply Ground
3	RX	Asynchronous Serial Receive Pin
4	TX	Asynchronous Serial Transmit Pin
5	GPIO5	Busy Signal
6	N/C	No Connect
7	N/C	No Connect
8	GPIO2	RX Bypass Pin
9	GPIO1	TX Bypass Pin
10	N/C	No Connect
11	N/C	No Connect
12	N/C	No Connect
13	N/C	No Connect
14	N/C	No Connect
15	GND	Supply Ground
16	5.0V	5V Input Supply

Note:
 GPIO 5 indicates if the Audio is playing. It can be used to trigger an external amplifier. Low indicates Audio output is occurring. High indicates no Audio output. SB3 requires to be shorted in order to utilize this functionality.

The designer can choose if the UART pins of the MOTG should be connected to either TX, RX or GPIO1, GPIO2 of the UMI. This is could be achieved by shorting the respective sides of solder bridges SB1 and SB2. This is discussed in detail in 2.3. Before Getting Started.

2.4.2. Solder Bridge Description

The MOTG-MP3 also has 3 solder bridges. The functionality of those solder bridges is described in the table below. These are soldered by the User.

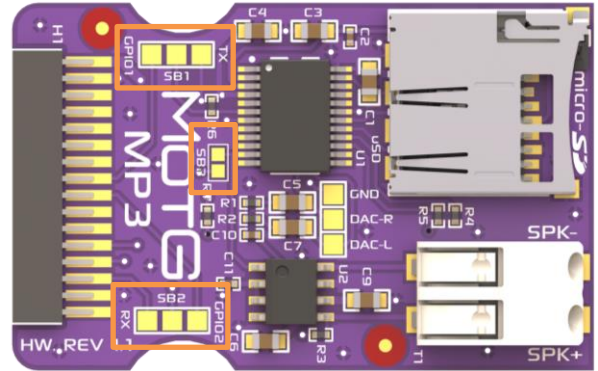

Solder Bridge	Description
SB1	TX Selector
SB2	RX Selector
SB3	Enable Busy Pin

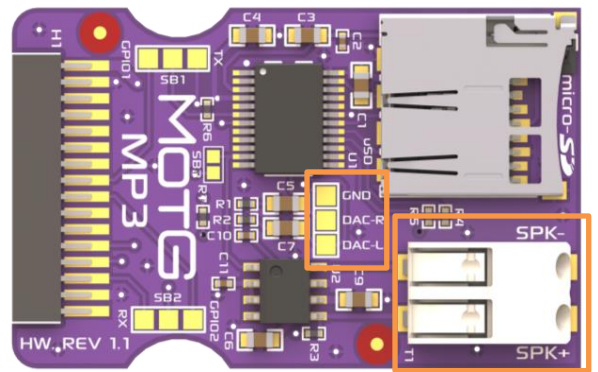

SPK+, SPK- provides a differential amplified output to a single speaker. Connect these pins to a 4/8/16/32 ohm speaker, at max of 3 watts when powered from a 5V supply. 8ohm 2.5W is recommended.

DAC_R, DAC_L provides the Left and Right audio outputs, capable of driving headphones directly or small speakers, or fed into an external amplifier. To utilise these signals, wires or pins can be soldered to these pads by the User.

2.5. Serial Commands

The SERIAL-MODE provides a simple 2-wire TTL Serial UART interface to any micro-controller capable of interfacing to 5.0V TLL Serial UART system that can be configured to output the simple protocol required to communicate with the MOTG-MP3.

Baud Rate: 9600 bps
 Data bits: 8
 Stop Bits: 1
 Parity bit: none
 Flow Control: none

The MOTG-MP3 audio operations such as PLAY, PAUSE, STOP, NEXT, PREVIOUS and VOLUME etc are all available to the host micro-controller to control using a simple set of bytes sent to the MOTG-MP3, along with many more, which can be found under the Valid Commands listed below.

Command Format: The format of the serial commands are as follows

FORMAT: \$S, CMD, Feedback, Para1, Para2, Checksum1, Checksum2, \$0		
\$S	Start Character \$S is 0x7E in HEX	Every command starts with this
CMD	Command Code	Every command has a unique command code, which determines the operation
Feedback	Command Feedback	Specifies whether feedback is required by the host microcontroller in reply to the command. 1 = Feedback, 0 = No Feedback
Para1	Parameter #1	First parameter of the specific Command Code
Para2	Parameter #2	Second parameter of the specific Command Code
Checksum1	Checksum #1	First byte of the checksum. Checksum calculation shown below
Checksum2	Checksum #2	Second byte of the checksum. Checksum calculation shown below.
\$0	End Character \$0 is 0xEF in HEX	Every command ends with this

Checksum Calculation:

The checksum is calculated using the following formula.

Checksum (2 bytes) = 0xFFFF – (CMD + Feedback + Para1 + Para2) + 1

Valid Commands:

All commands shown below have Feedback turned off so there will be no data sent from the MOTG-MP3 after the command has been sent from the microcontroller (except for the Query commands which are requesting data).

Function	Serial Command	Description
NEXT	7E 01 00 00 00 FF FF EF	If no track is currently playing, issuing the NEXT command will start playing the first track copied to the media (see Section 6). If the MOTG-MP3 is currently playing a song or has previously played a song, this will play the next song in the order copied on to the media.
PREVIOUS	7E 02 00 00 00 FF FE EF	If no track is currently playing, issuing the PREVIOUS command will start playing the last track copied to the media (see Section 6). If the MOTG-MP3 is currently playing a song or has previously played a song, this will play the previous song in the order copied on to the media.
SPECIFY TRACK #	7E 03 00 00 01 FF FC EF 7E 03 00 00 02 FF FB EF 7E 03 00 00 0A FF F3 EF	Start playing the first track copied to the media. (See Section 6) This will start playing the second track copied to the media. This will start playing the tenth track copied to the media.
VOLUME +	7E 04 00 00 00 FF FC EF	This will increase the volume by 1 (0 – 30 range, level 20 is default power on setting)
VOLUME -	7E 05 00 00 00 FF FB EF	This will decrease the volume by 1 (0 – 30 range, level 20 is default power on setting)
VOLUME #	7E 06 00 00 1E FF DC EF 7E 06 00 00 05 FF F5 EF	This will set the volume to be 30 (30 is the Max) This will set the volume to be 5
SPECIFY EQ	7E 07 00 00 01 FF F8 EF 7E 07 00 00 04 FF F5 EF	This will set the EQ to pop This will set the EQ to classic (0/1/2/3/4/5 Normal, Pop, Rock, Jazz, Classic, Bass)
REPEAT A TRACK	7E 08 00 00 01 FF F7 EF 7E 08 00 00 02 FF F6 EF 7E 08 00 00 1F FF D9 EF	This will repeat the first track copied to the media. (See Section 2.6) This will repeat the second track copied to the media. This will repeat the thirty first track copied to the media.
PLAY SOURCE	7E 09 00 00 02 FF F5 EF	This will set the MOTG-MP3 to play from a micro-SD Card
RESET	7E 0C 00 00 00 FF F4 EF	This will reset the MOTG-MP3, to be in its powered-on state
PLAY	7E 0D 00 00 00 FF F3 EF	Play the audio track selected (if selected) else the first track copied on to the media (See Section 2.6)
PAUSE	7E 0E 00 00 00 FF F2 EF	Pause the current playing audio Track. If PLAY command is then sent, the audio track will resume from where it was paused.
SPECIFY FOLDER & TRACK	7E 0F 00 01 01 FF EF EF 7E 0F 00 01 0A FF E6 EF 7E 0F 00 63 FF FE 8F EF	This will start playing Folder 1 from Track 1. (See Section 2.6) This will start playing Folder 1 from Track 10. This will start playing Folder 99 from Track 255
CONTINUOUS	7E 11 00 00 01 FF EE EF	This will enable continuous mode (disable RANDOM TRACK and REPEAT CURRENT if previously enabled), which will play all songs on the memory card, one after the other. Start track with PLAY .
STOP	7E 16 00 00 00 FF EA EF	Stop the current playing audio Track. If PLAY command is then sent, the audio track will start from the beginning.
RANDOM TRACK	7E 18 00 00 00 FF E8 EF	This will enable Random Mode (disable CONTINUOUS and REPEAT CURRENT if previously enabled), which plays random tracks one after the other, continuously. Start track with PLAY .
REPEAT CURRENT	7E 19 00 00 00 FF E7 EF	This will enable the repeat play mode (disable CONTINUOUS and RANDOM TRACK if previously enabled), which repeats the currently playing track, so it will play over and over continuously. Track must be playing before this command is sent.
SINGLE PLAY	7E 19 00 00 01 FF E6 EF	This will disable CONTINUOUS, RANDOM TRACK or REPEAT CURRENT modes if previously enabled, which is how the module starts up by default. This will allow one song to play and then stop. Start track with PLAY .

QUERY VOLUME	7E 43 00 00 00 FF BD EF	Query the current volume.
QUERY EQ	7E 44 00 00 00 FF BC EF	Query the current EQ Setting (0/1/2/3/4/5 Normal, Pop, Rock, Jazz, Classic, Bass)
QUERY TRACKS uSD	7E 48 00 00 00 FF B8 EF	Query the number of files present on the uSD
QUERY CURRENT TRACK uSD	7E 4C 00 00 00 FF B4 EF	Query the current track playing from the micro-SD Card
QUERY TRACKS FOLDER	7E 4E 00 00 01 FF B1 EF 7E 4E 00 00 0B FF A7 EF	This will return the number of tracks in Folder 1 (001) This will return the number of tracks in Folder 11 (011)

Successful command received by MOTG-MP3 (Feedback Byte needs to be ON):

If Feedback is required for successful receipt of a command, simply change the Feedback byte from 0x00 to 0x01, and a confirmation message will be sent from the MOTG-MP3 after the command is sent and received.

Feedback Received	Description
7E 41 00 00 00 FF BF EF	Command Successfully Received

Errors received from the MOTG-MP3:

If a command is sent to the MOTG-MP3 and the MOTG-MP3 resulted in an error from that command, the following messages could be sent. These are sent on error regardless of if the feedback byte is enabled or disabled.

ERRORS Received	Description
7E 40 00 00 01 FF BF EF	Module is busy
7E 40 00 00 02 FF BE EF	Module is currently in sleep mode
7E 40 00 00 03 FF BD EF	Serial received an error
7E 40 00 00 04 FF BC EF	Checksum error
7E 40 00 00 05 FF BB EF	Beyond scope of specified file/folder
7E 40 00 00 06 FF BA EF	Specified file/Folder not found

Other information received from MOTG-MP3:

These commands are sent from the MOTG-MP3 when certain events occur, and could come at various times.

DATA Received	Description
7E 3A 00 00 02 FF C4 EF	micro-SD Card Inserted. Sent every time a micro-SD card is inserted.
7E 3B 00 00 02 FF C3 EF	micro-SD Card Removed. Sent every time a micro-SD card is ejected. NOTE: when the card is ejected, multiple messages may be sent (ejected, inserted and ejected again). This is a side-effect of the type of micro-SD socket that is installed if the card is ejected slowly, ie holding in the card before releasing.
7E 3D 00 00 02 FF C1 EF 7E 3D 00 00 0A FF B9 EF	micro-SD Card source, Finished playing Track 02 micro-SD Card source, Finished playing Track 10 (0x0A)
7E 3F 00 00 00 FF C1 EF	MOTG-MP3 has just started up, No media detected
7E 3F 00 00 02 FF BF EF	MOTG-MP3 has just started up, micro-SD Card detected

2.6. Media – micro-SD card

The MOTG-MP3 uses off the shelf micro-SD and micro-SD-HC memory cards with up to 32GB capacity, and compatible with both FAT16 and FAT32 file formats. The formatting of the card can be done on any PC/Mac/Linux system with a card reader. Select appropriate drive and choose the FAT16 or FAT32 file format, depending on capacity of your micro-SD card. The card is now ready to be used in the MOTG-MP3.

NOTE: Certain brands of micro-SD memory cards may not work properly. This is evident by some files that may be skipped and not played by the MOTG-MP3.

2.7. File & Folder Structure

The MOTG-MP3 is flexible how files are stored on the micro-SD, however in order to have control over which files are played, it is important to follow some simple naming rules in order for the MOTG-MP3 to play the specific file you intend to play.

The MOTG-MP3 is capable of addressing up to 99 Folders, each with up to 255 songs.

MOTG-MP3 is not capable of reading ID3 information from the MP3 files, so purely relies on the name of the file as the index (Primary method), or the order the files were copied onto the media (Secondary Method).

While MOTG-MP3 files can be named almost anything and they will play, in order to index the files so they can be picked on request using a specific serial command to select the folder/file using the Primary Method, the following must be observed:

001ABCDEFGF.mp3

Where 001 refers to the track number from 1 (001) to 255 as the MOTG-MP3 can address up to 255 songs in each folder, and ABCDEFG refers to any alphanumeric name of your choosing, where the total file name length can be 32 characters long (Operating System dependant), ending with .mp3 extension.

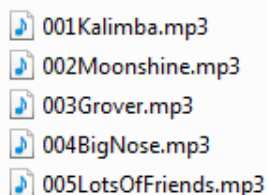

001Kalimba.mp3
002Moonshine.mp3
003Grover.mp3
004BigNose.mp3
005LotsOfFriends.mp3

The folder structure should have then the following naming convention:

01

Where 01 refers to a number from 01 to 99, as the MOTG-MP3 can address up to 99 folders.

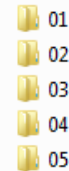

01
02
03
04
05

If Songs are placed on the media and they may or may not follow the naming convention, then the song can be played using the **PLAY, NEXT, PREV** commands or buttons, or using the **SPECIFY TRACK #** command, which uses the Secondary Method and plays based on the order the songs were copied (Secondary Method) on to the media and not the name or location of the files.

The **SPECIFY FOLDER & TRACK** command however cannot be used if the naming convention has not been followed (Primary Method), as this relies on the formatting above to be observed.

Note, when using the **SPECIFY FOLDER & TRACK** command, Folder and Track numbering is in HEX. So the Folders are 0x01 through 0x63 (1 to 99), and the Tracks are 0x01 through 0xFF (1 to 255).

If the above formatting is observed, all commands will work correctly, so both Primary and Secondary methods are functional.

It may be difficult to determine the order songs were copied onto the media, so the Secondary Method should only be used if the order is not critical or the copy order is known. The Primary Method should be used as the preferred method.

2.8. Mechanical Views

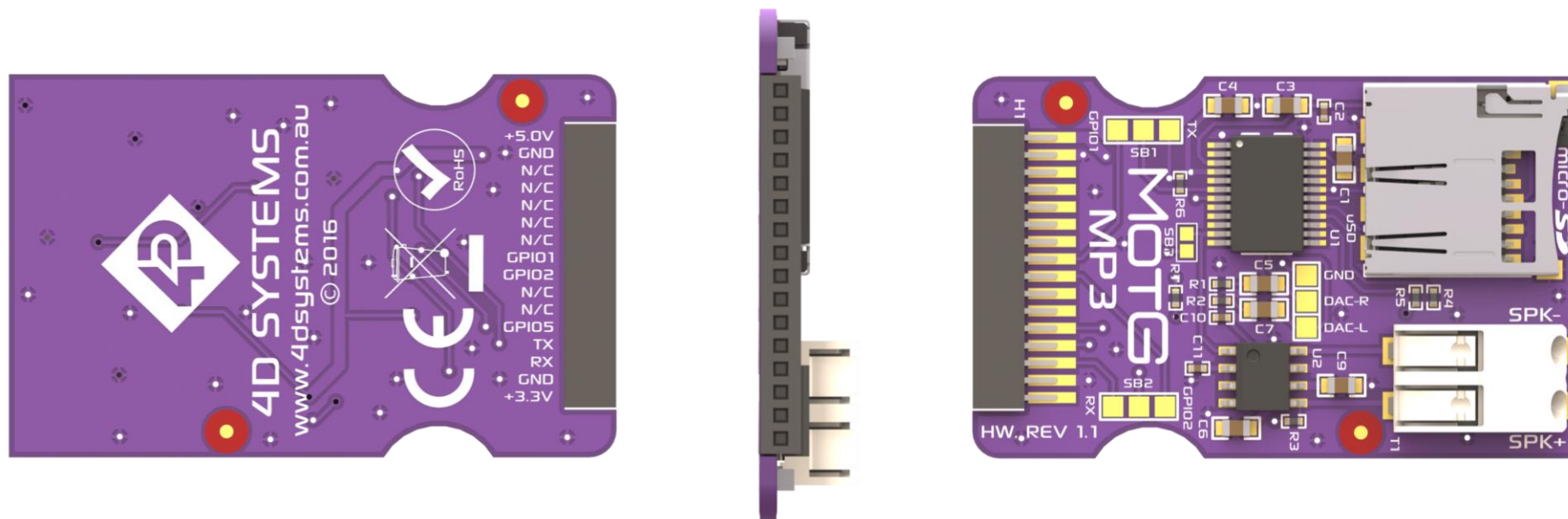

2.9. Schematic Details

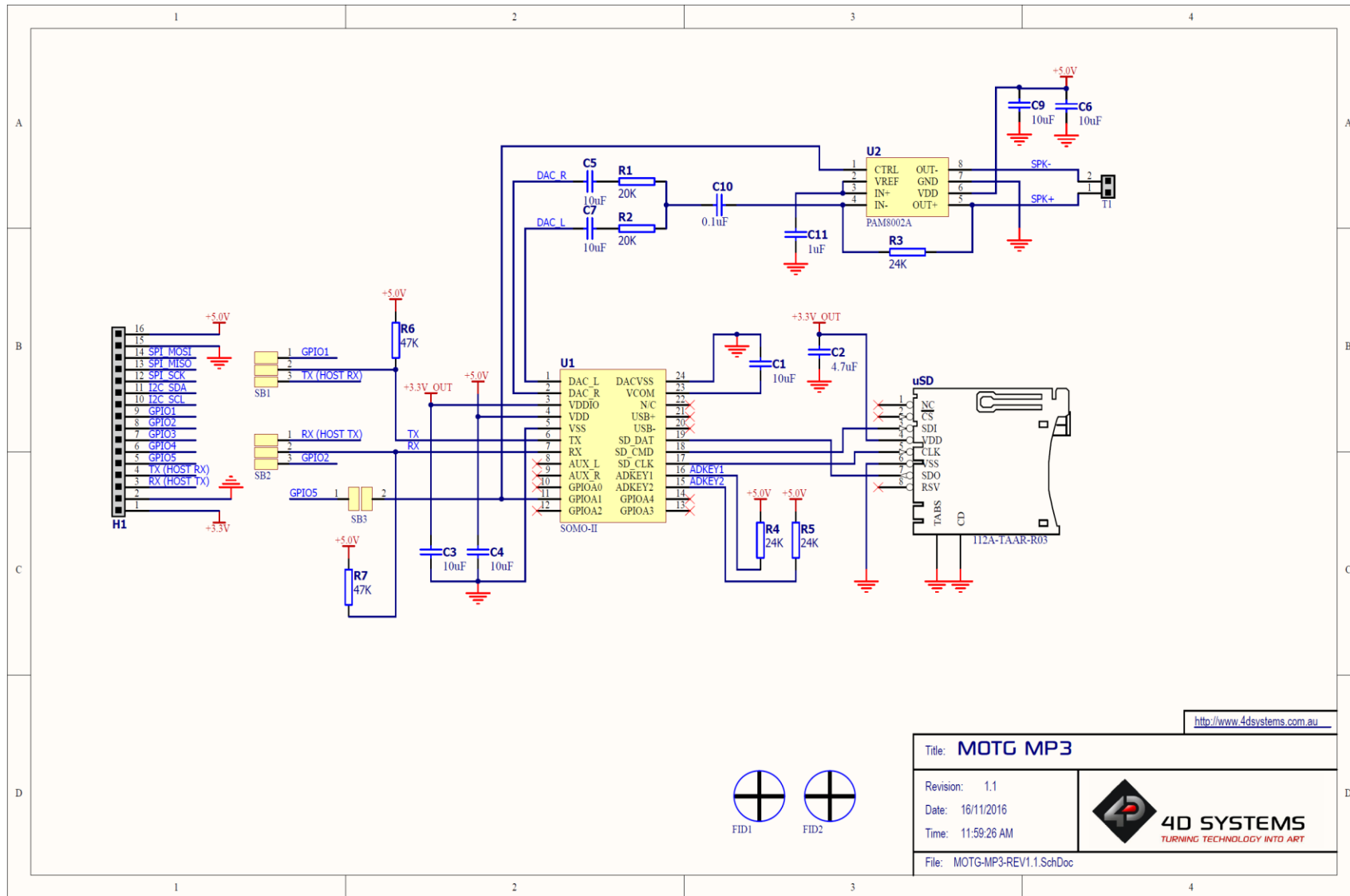

2.10. Specifications

RECOMMENDED OPERATING CONDITIONS					
Parameter	Conditions	Min	Typ	Max	Units
Supply Voltage (VCC)		3.3	5.0	5.0	V
Operating Temperature		0.0	--	70.0	°C
Input Low Voltage (VIL)	All pins	-0.3	--	0.3*VCC	V
Input High Voltage (VIH)	All pins	0.7*VCC	--	VCC+0.3	V

GLOBAL CHARACTERISTICS BASED ON OPERATING CONDITIONS					
Parameter	Conditions	Min	Typ	Max	Units
Supply Current (ICC)	VCC = 5.0V, Audio Playing	30.0	--	300.0	mA
Standby Current	VCC = 5.0V	--	20.0	--	uA
Output Low Voltage (VOL)		--	--	0.3	V
Output High Voltage (VOH)		2.7	--	VCC	V

3. MOTG-RS232



3.1. Description

RS232 is a standard communication port for various industry and networking equipment. However, most of the microcontrollers do not facilitate direct RS232 communication as they do not support RS232 voltage levels.

MOTG-RS232 provides a low power, high speed and low cost solution for incorporating RS232 serial communication to your design.

3.2. Features

- Level conversion using ST232CDR IC by ST
- Supports both 3.3V and 5V power supply
- Up to 400kbps data rate
- ±25V input levels
- 300 µA supply current
- 6 V/µs minimum slew rate
- Supports 2-wire 3.3V/5V TTL UART interface (the logic depends on the supply)

3.3. Before Getting Started

Out of the box, the chipset's UART pins are not connected to the UMI of the MOTG.

MOTG-RS232 hardware allows the UART pins to be connected to either TX, RX or GPIO1, GPIO2 of the UMI. This is could be achieved by shorting the respective sides of solder bridges SB1 and SB2 using a solder blob and a soldering iron. This is done by the User.

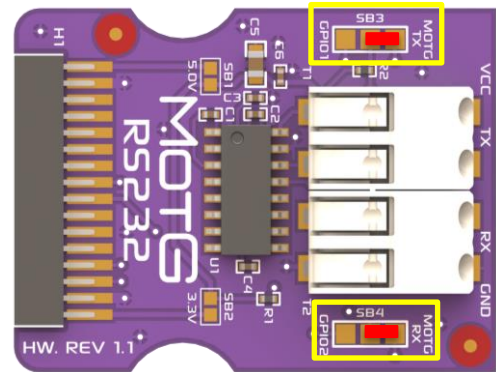

Unless the designer intends to use 2 UART MOTGs on a gen4-MOTG-AC2 board, the UART pins should be directed to TX, RX of the UMI as shown above.

When two UART MOTGs are being used on a gen4-MOTG-AC2 board, the UART pins of one of the MOTGs should be diverted to GPIO1 and GPIO2 of the UMI, as shown below. This prevents both MOTGs from utilising the same pins of the gen4 display module for UART communication.

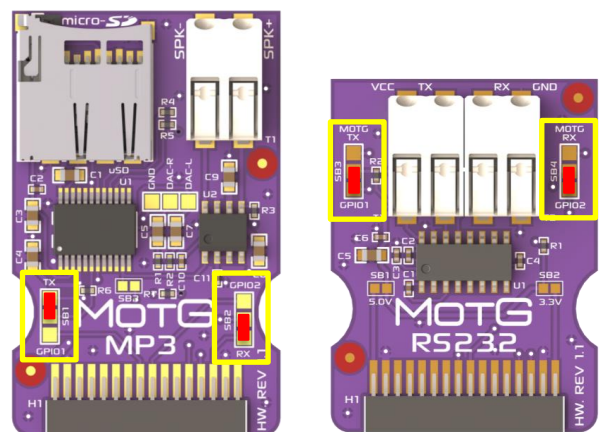

3.4. Chipset Features

MOTG-RS232 carries the ST3232, low power RS232 driver and receiver IC. The data sheet for the ST3232 is available from the <http://www.st.com/> website.

3.5. Pins and Solder Bridges

3.5.1. Pin Description

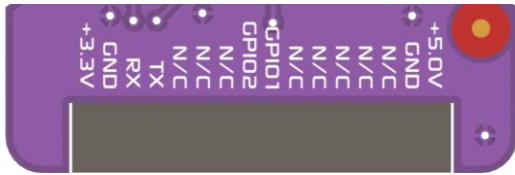

Pin	Symbol	Description
1	3.3V	3.3V Input Supply
2	GND	Supply Ground
3	RX	Asynchronous Serial Receive Pin
4	TX	Asynchronous Serial Transmit Pin
5	N/C	No Connect
6	N/C	No Connect
7	N/C	No Connect
8	GPIO2	RX Bypass Pin
9	GPIO1	TX Bypass Pin
10	N/C	No Connect
11	N/C	No Connect
12	N/C	No Connect
13	N/C	No Connect
14	N/C	No Connect
15	GND	Supply Ground
16	5.0V	5V Input Supply

Note:

Designer can choose if the UART pins of the MOTG should be connected to either TX, RX or GPIO1, GPIO2 of the UMI. This is could be achieved by shorting the respective sides of solder bridges SB1 and SB2. This is discussed in detail in 3.3. Before Getting Started.

3.5.2. Solder Bridge Description

The MOTG-RS232 also has 4 solder bridges. The functionality of those solder bridges is described in the table below. These are soldered by the User.

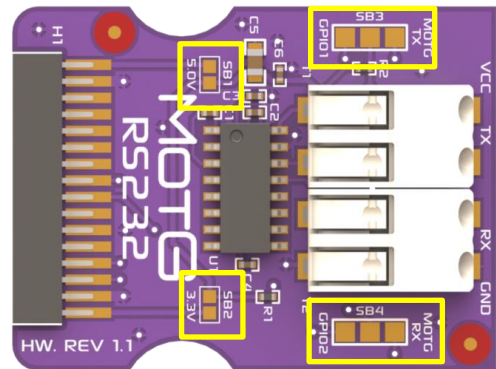

Solder Bridge	Description
SB1	Short SB1 for 5.0V input supply
SB2	Short SB2 for 3.3V input supply
SB3	TX selector
SB4	RX Selector

The MOTG-RS232 supports both 3.3V and 5V supply. The preferred supply voltage could be chosen by shorting the appropriate solder bridge.

3.6. Mechanical Views

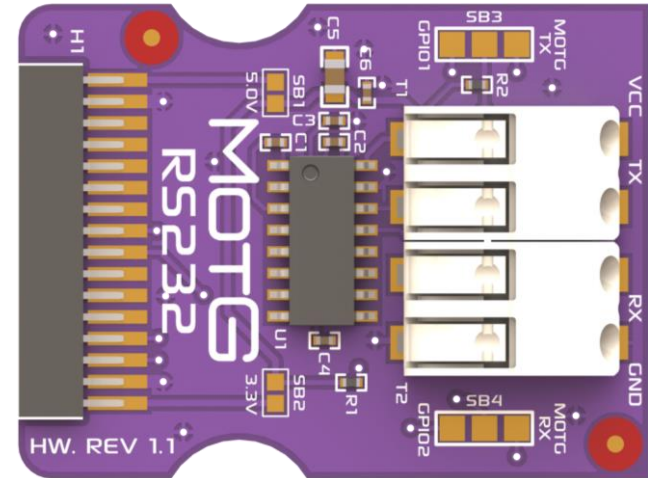
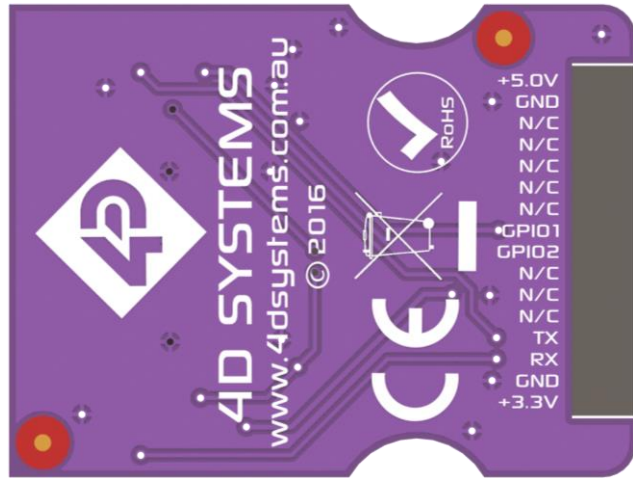

3.7. Schematic Details

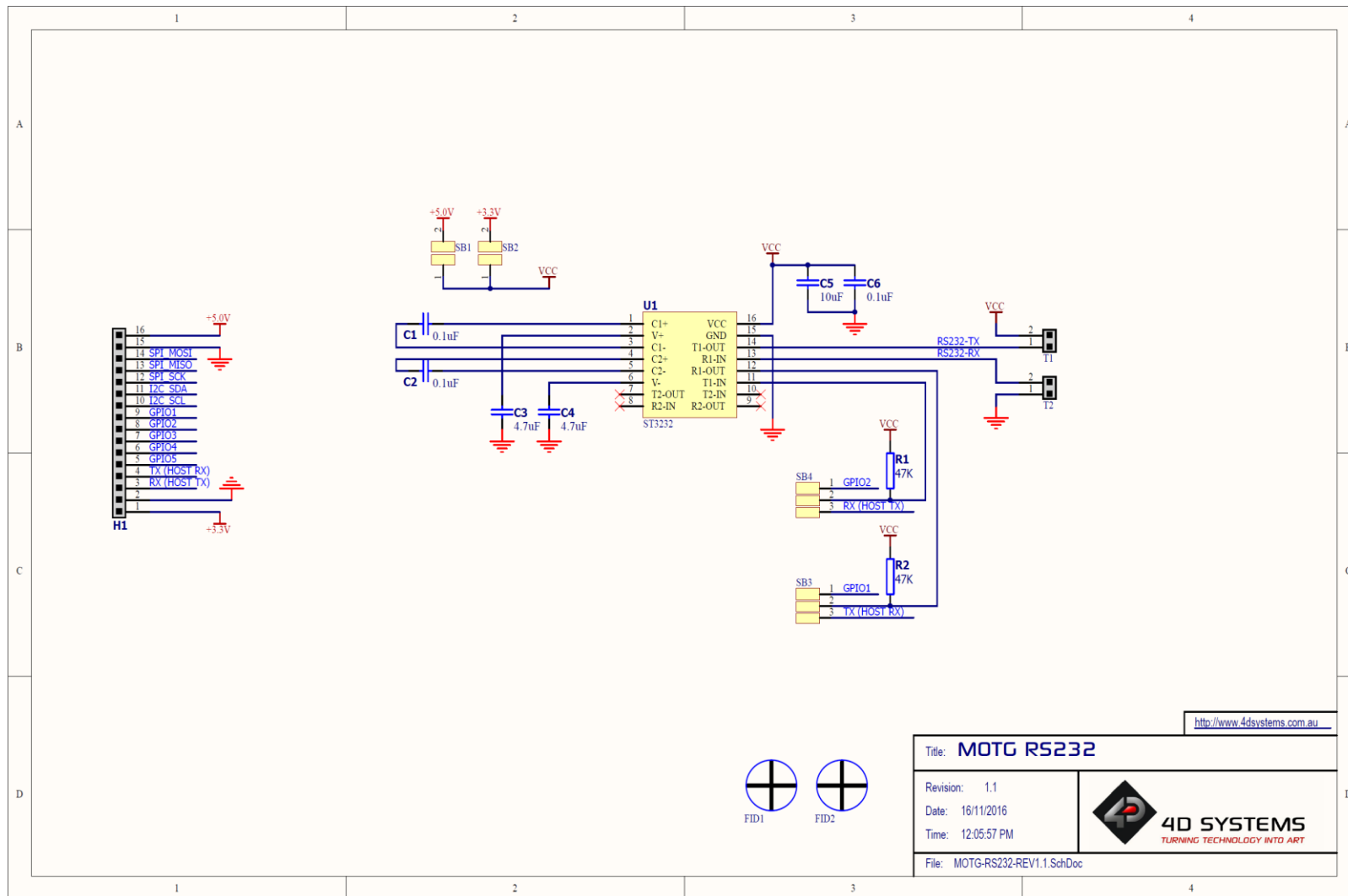

MOTG – Modules On The Go Series

3.8. Specifications

RECOMMENDED OPERATING CONDITIONS					
Parameter	Conditions	Min	Typ	Max	Units
Supply Voltage (VCC)		3.0	--	5.0	V
Operating Temperature		0.0	--	70.0	°C
Input Low Voltage (VIL)	T-IN	--	--	0.8	V
Input High Voltage (VIH)	VCC = 3.3 V	2.0	--	--	V
	VCC = 5 V	2.4	--	--	V

GLOBAL CHARACTERISTICS BASED ON OPERATING CONDITIONS					
Parameter	Conditions	Min	Typ	Max	Units
Supply Current (ICC)	No Load, TA = 25°C, VCC = 3V or 5V	--	0.3	1.0	mA
Transmitter Input Voltage		-0.3	--	6.0	V
Receiver Output Voltage		-0.3	--	VCC+0.3	V
Receiver Input Voltage		-25.0	--	25.0	V
Transmitter Output Voltage		-13.2	--	13.2	V

4. MOTG-RS485



4.1. Description

RS485 is a standard communication port for various industry and networking equipment and enables easy configuration of local networks and multipoint communications links. Unfortunately, most of the microcontrollers do not support RS485 voltage levels.

MOTG-RS485 provides a high speed and low cost solution for incorporating RS485 Serial communication to your design.

4.2. Features

- ST1480ACDR differential line transceiver
- 3.3V power supply only
- ESD protection: ±15 kV human body model
- Guaranteed 12 Mbps data rate
- 7 to 12 common model input voltage range
- Supports 2-wire 3.3V/5V TTL UART interface

4.3. Before Getting Started

Out of the box, the chipset's UART pins are not connected to the UMI of the MOTG.

MOTG-RS485 hardware allows the UART pins to be connected to either TX, RX or GPIO1, GPIO2 of the UMI. This is could be achieved by shorting the respective sides of solder bridges SB2 and SB3 using a solder blob and a soldering iron. This is done by the User.

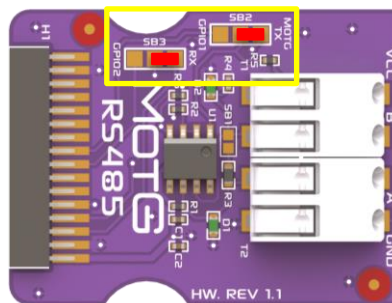

Unless the designer intends to use 2 UART MOTGs on a gen4-MOTG-AC2 board, the UART pins should be directed to TX, RX of the UMI as shown above.

When two UART MOTGs are being used on a gen4-MOTG-AC2 board, the UART pins of one of the MOTGs should be diverted to GPIO1 and GPIO2 of the UMI, as shown below. This prevents both MOTGs from utilising the same pins of the gen4 display module for UART communication.

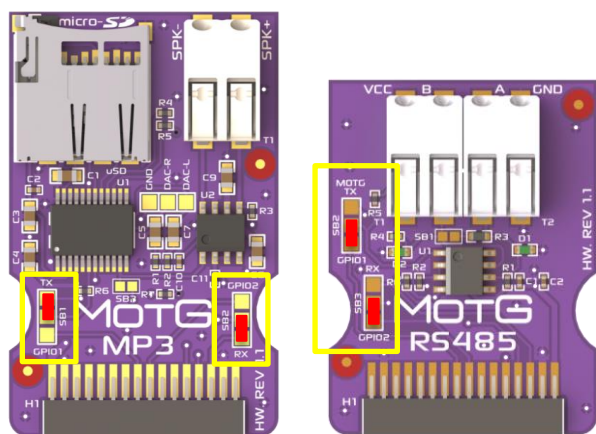

4.4. Chipset Features

MOTG-RS485 carries a ST1480ACDR differential line transceiver. The data sheet for the ST3232 is available from the <http://www.st.com/> website.

4.5. Pins and Solder Bridges

4.5.1. Pin Description



Pin	Symbol	Description
1	3.3V	3.3V Input Supply
2	GND	Supply Ground
3	RX	Asynchronous Serial Receive Pin
4	TX	Asynchronous Serial Transmit Pin
5	N/C	No Connect
6	N/C	No Connect
7	N/C	No Connect
8	GPIO2	RX Bypass Pin
9	GPIO1	TX Bypass Pin
10	N/C	No Connect
11	N/C	No Connect
12	N/C	No Connect
13	N/C	No Connect
14	N/C	No Connect
15	GND	Supply Ground
16	N/C	No Connect

Note:

Designer can choose if the UART pins of the MOTG should be connected to either TX, RX or GPIO1, GPIO2 of the UMI. This is could be achieved by shorting the respective sides of solder bridges SB2 and SB3. This is discussed in detail in 4.3. Before Getting Started.

4.5.2. Solder Bridge Description

The MOTG-RS485 also has 3 solder bridges. The functionality of those solder bridges is described in the table below. These are soldered by the User.

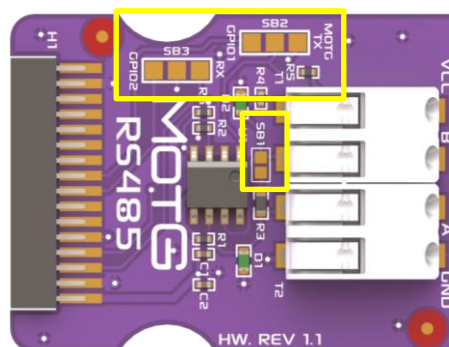

Solder Bridge	Description
SB1	Short to place terminating resistor
SB2	TX selector
SB3	RX Selector

Solder Bridge 1 (SB1) provides the option of placing or removing the terminating resistor in to the design. Each differential pair of wires is a remission line and proper termination of the line will prevent reflection. MOTG-RS485 has an inbuilt termination resistor (120 ohms) for this purpose.

4.6. Mechanical Views

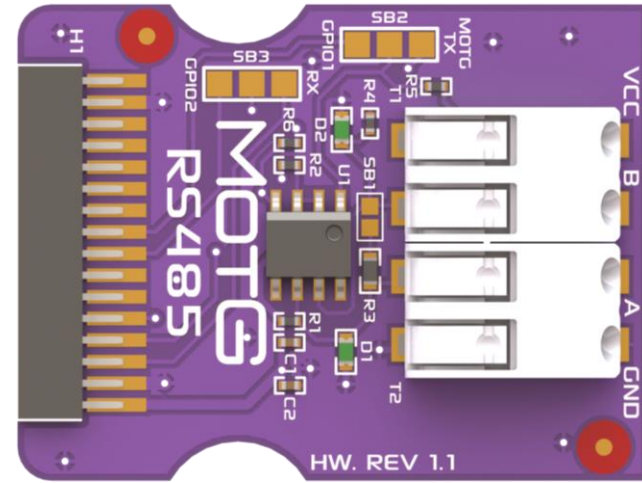
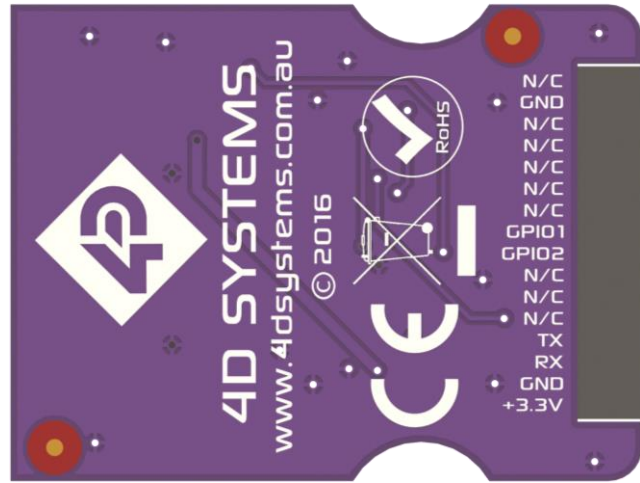

4.7. Schematic Details

MOTG – Modules On The Go Series

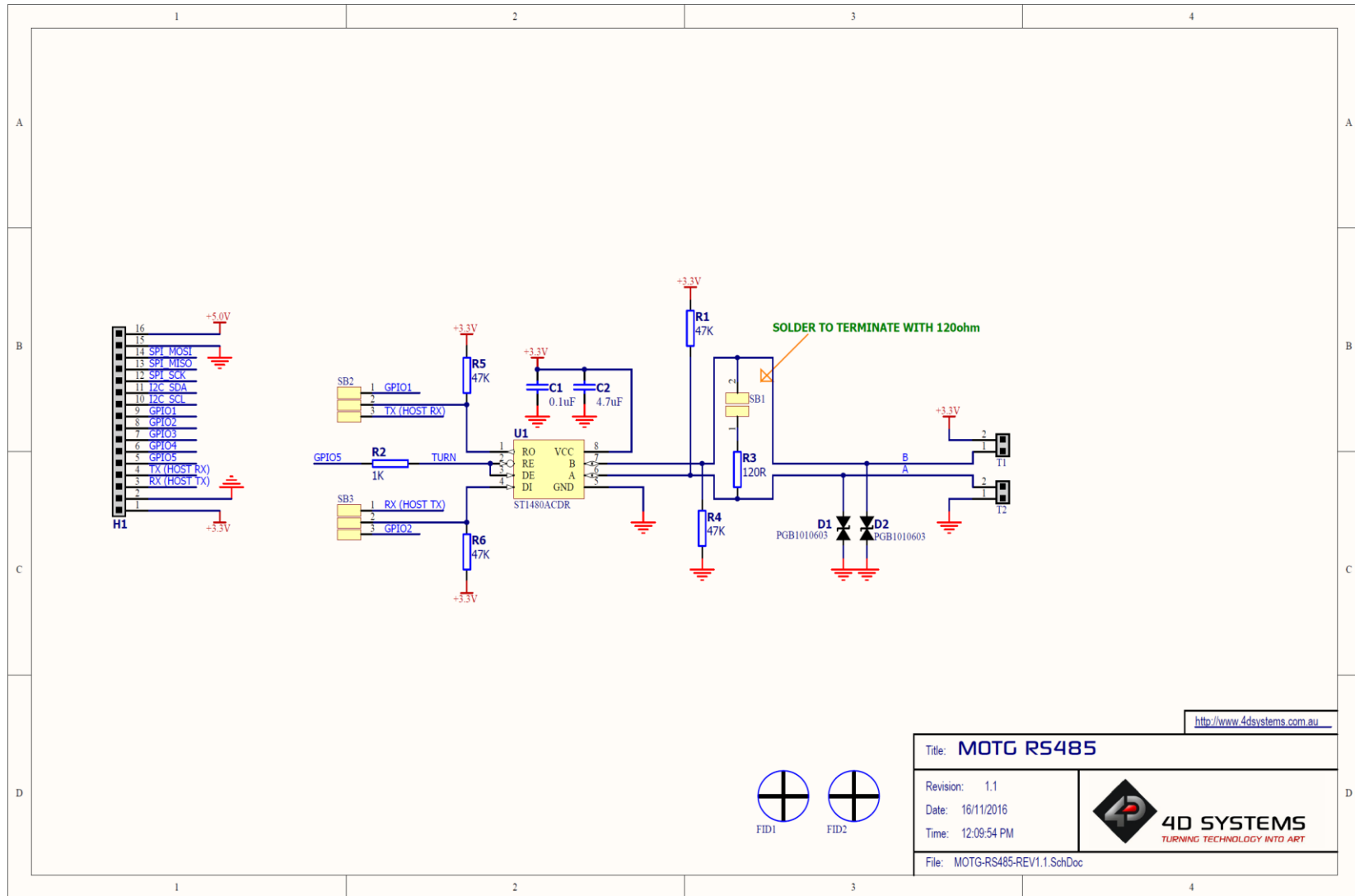

<http://www.4dsystems.com.au>

Title: MOTG R5485	
Revision: 1.1	 4D SYSTEMS <small>TURNING TECHNOLOGY INTO ART</small>
Date: 16/11/2016	
Time: 12:09:54 PM	
File: MOTG-RS485-REV1.1.SchDoc	

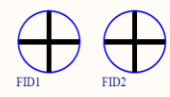

4.8. Specifications

RECOMMENDED OPERATING CONDITIONS					
Parameter	Conditions	Min	Typ	Max	Units
Supply Voltage (VCC)		3.0	--	3.6	V
Operating Temperature		0.0	--	70.0	°C
Input Low Voltage (VIL)	DE, DI, RE	--	--	0.8	V
Input High Voltage (VIH)	DE, DI, RE	2.0	--	--	V

GLOBAL CHARACTERISTICS BASED ON OPERATING CONDITIONS					
Parameter	Conditions	Min	Typ	Max	Units
Supply Current (ICC)	No Load, DI = 0 V or VCC, DE=VCC, RE=0 V or VCC	--	1.3	2.2	mA
Transmitter Input Voltage	No Load, DI=0 V or VCC, DE=0 V, RE=0 V	--	1.2	1.9	mA
Control Input Voltage		-0.3	--	7.0	V
Driver Input Voltage		-0.3	--	7.0	V
Receiver Output Voltage		-0.3	--	VCC+0.3	V
Receiver Input Voltage		-14.0	--	14.0	V
Driver Output Voltage		-14.0	--	14.0	V

4.9. Hardware Revision History

Revision Number	Date	Description
1.1	16/11/2016	Initial Public Release version

End of MOTG-RS485 Datasheet

5. MOTG-BLUETOOTH

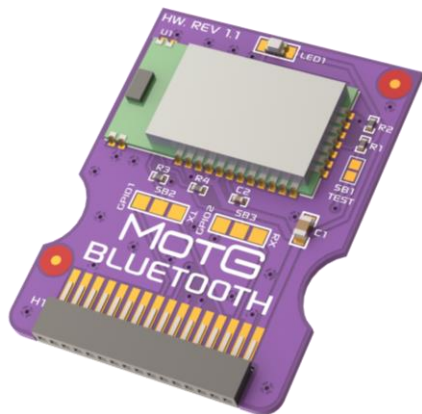

5.1. Description

MOTG-BLUETOOTH provides low cost and low energy solution for all embedded Bluetooth applications. The MOTG-BLUETOOTH carries a RN4870 Bluetooth module, providing a complete solution to implement Bluetooth 4.2 Low energy connectivity.

The MOTG-BLUETOOTH can be dynamically configured easily using ASCII commands using the host microcontroller.

5.2. Features

- RN4870 Bluetooth Module by Microchip with
 - Bluetooth 4.2 Low Energy Stack
 - ASCII Command interface API over UART
 - Secure AES128 Encryption
- 3.3V Power supply only
- Supports 2-Wire 3.3V TTL UART Interface
- Integrated Ceramic Chip Antenna
- On board Status LED
- Remote Configuration Over The Air
- ISM Band 2.402 GHz to 2.480 GHz Operation
- Channels: 0-39
- Receive Sensitivity: -90 dBm (LE)
- Transmit Power: 0dBm

5.3. Before Getting Started

Out of the box, the chipset's UART pins are not connected to the UMI of the MOTG.

MOTG-BLUETOOTH hardware allows the UART pins to be connected to either TX, RX or GPIO1, GPIO2 of the UMI. This is could be achieved by shorting the respective sides of solder bridges SB2 and SB3 using a solder blob and soldering iron. This must be completed by the User.

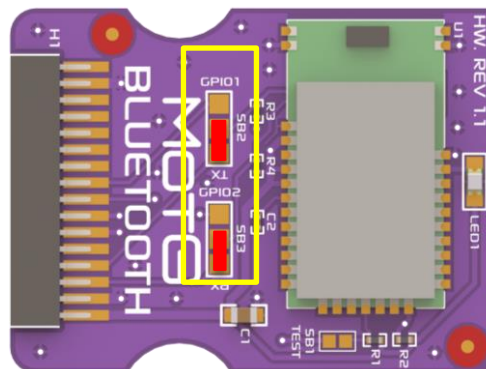

Unless the designer intends to use 2 UART MOTGs on a gen4-MOTG-AC2 board, the UART pins should be directed to TX, RX of the UMI as shown above.

When two UART MOTGs are being used on a gen4-MOTG-AC2 board, the UART pins of one of the MOTGs should be diverted to GPIO1 and GPIO2 of the UMI, as shown below. This prevents both MOTGs from utilising the same pins of the gen4 display module for UART communication.

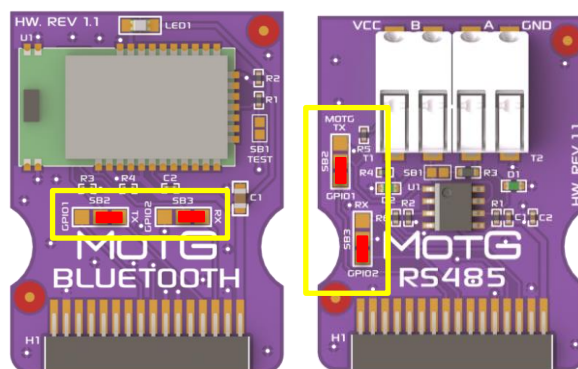

5.4. Chipset Features

5.4.1. The RN4870 Bluetooth Module



The RN4870 module, based on Microchip’s IS187x Bluetooth LE ICs, is a leading platform for Bluetooth related projects or Internet of Things (IoT). This Bluetooth Low Energy module incorporates Bluetooth 4.2 baseband controller, on-board Bluetooth stack and RF power amplifier.

The data sheet for the RN4870 is available from the <https://www.microchip.com> website. In addition, more support has been made available for this module by Microchip.

5.5. Pins and Solder Bridges

5.5.1. Pin Description



Pin	Symbol	Description
1	3.3V	3.3V Input Supply
2	GND	Supply Ground
3	RX	Asynchronous Serial Receive Pin
4	TX	Asynchronous Serial Transmit Pin
5	N/C	No Connect
6	GPIO4	P2_0/MODE Pin
7	GPIO3	Reset pin. An active Low pulse will reset the module
8	GPIO2	RX Bypass
9	GPIO1	TX Bypass
10	N/C	No Connect
11	N/C	No Connect
12	N/C	No Connect
13	N/C	No Connect
14	N/C	No Connect
15	GND	Supply Ground
16	N/C	No Connect

Note:

Designer can choose if the UART pins of the MOTG should be connected to either TX, RX or GPIO1, GPIO2 of the UMI. This is could be achieved by shorting the respective sides of solder bridges SB2 and SB3. This is discussed in detail in 5.3. Before Getting Started.

5.5.2. Solder Bridge Description

The MOTG-BLUETOOTH has 3 solder bridges. The functionality of those solder bridges is described in the table below. These are soldered by the User.

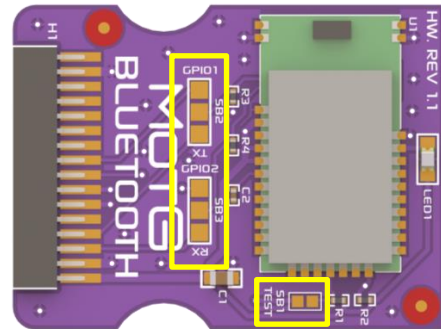

Solder Bridge	Description
SB1	Short to use the GPIO4 to change/upgrade firmware
SB2	TX selector
SB3	RX Selector

5.6. Firmware Programming

The MOTG-BLUETOOTH comes pre-programmed with the firmware version 1.18.3. If an updated command set is desired instead, then the default firmware will be lost. The following procedure outlines how to reload the RN4870 with the default firmware. Below are the six pins of the MOTG-BLUETOOTH that will be used when uploading a firmware.

- +3.3V (not 5V tolerant)
- GND
- RX
- TX
- GPIO3 (Reset)
- GPIO4 (P2_0/MODE)

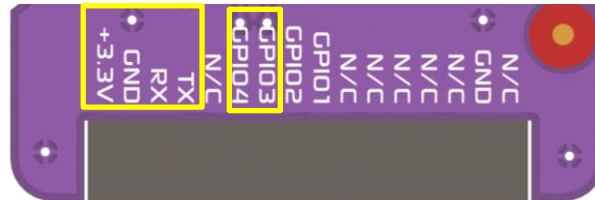

In this case, a gen4-MOTG-AC1 is used to gain access to the essential pins of the MOTG-BLUETOOTH. However, other gen4-MOTG-AC interface boards provided by 4D Systems could be used as well. The gen4-MOTG-AC1 is then interfaced to the gen4-PA, which essentially serves as a breakout board for the UMI pins in this setup.

Note: If you opt to use MOTG-BREADTOOTH instead of the gen4-MOTG-AC1 + gen4-PA combo, the 5V needs to be dropped to 3.3V externally, as MOTG-BREADTOOTH does not facilitate this internally.

Lastly, a programming module is needed to program the MOTG-WiFi-ESP through the gen4-MOTG-AC1 + gen4-PA combo. This process does not necessarily require a 4D Systems programming module - the 4D USB programming cable or the uUSB-PA5. However these are compatible and could be used to perform this procedure.

Carefully, slide the MOTG-BLUETOOTH on the gen4-MOTG-AC1 board. Connect the 4D programming module to the corresponding pins of the gen4 PA as shown in the image below.

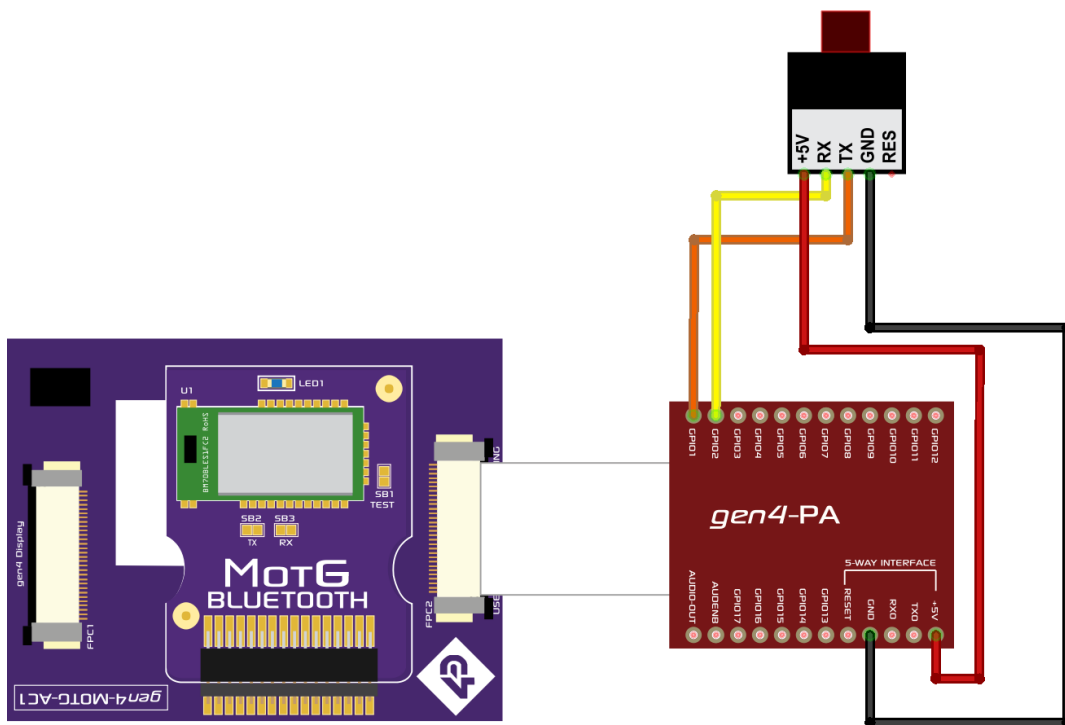

The RN4870 needs to be placed into Test mode. The following procedure will place the Bluetooth module in Test mode.

- Connect GPIO 9 (P2_0/MODE Pin) of the gen4 PA to Ground.

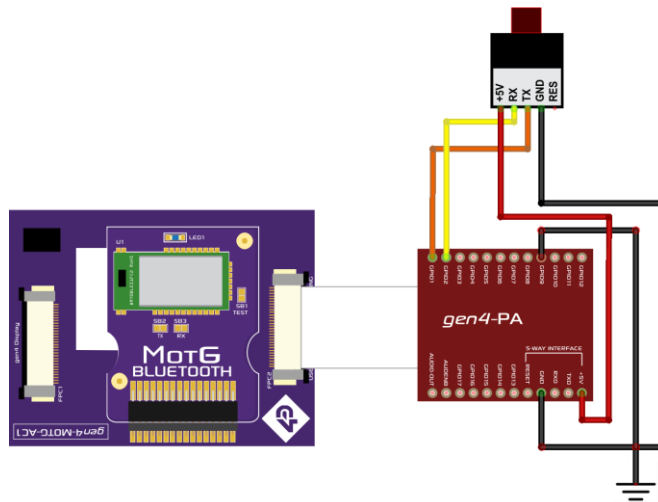

- While GPIO 9 of the gen4 PA is grounded, connect the GPIO10 (Reset) pin to Ground for a second and disconnect it (Reset) from Ground.

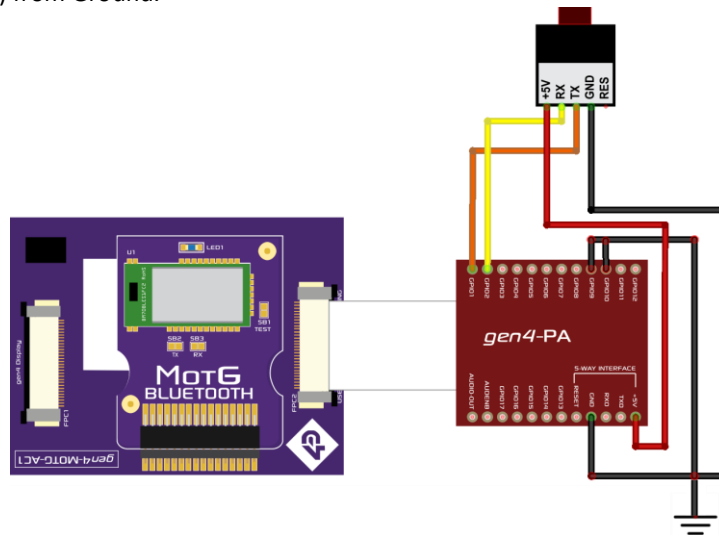

- Now disconnect GPIO 9 as well from Ground.

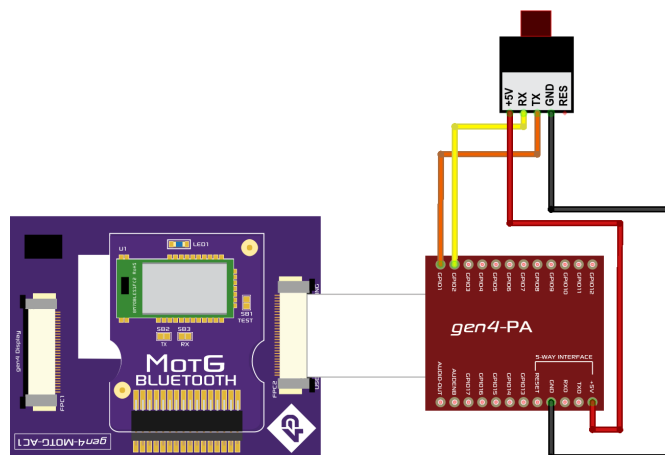

Please download the RN4870 firmware files from the MOTG-BLUETOOTH product page on the 4D Systems website. Extract the files to a known location on your hard drive that is easy to access.

Run the IUpdate Programming Utility and set the baudrate to **115200** and the memory type to **Flash/Embedded**. Then check the com port of the 4D programming module and change it accordingly in the application.

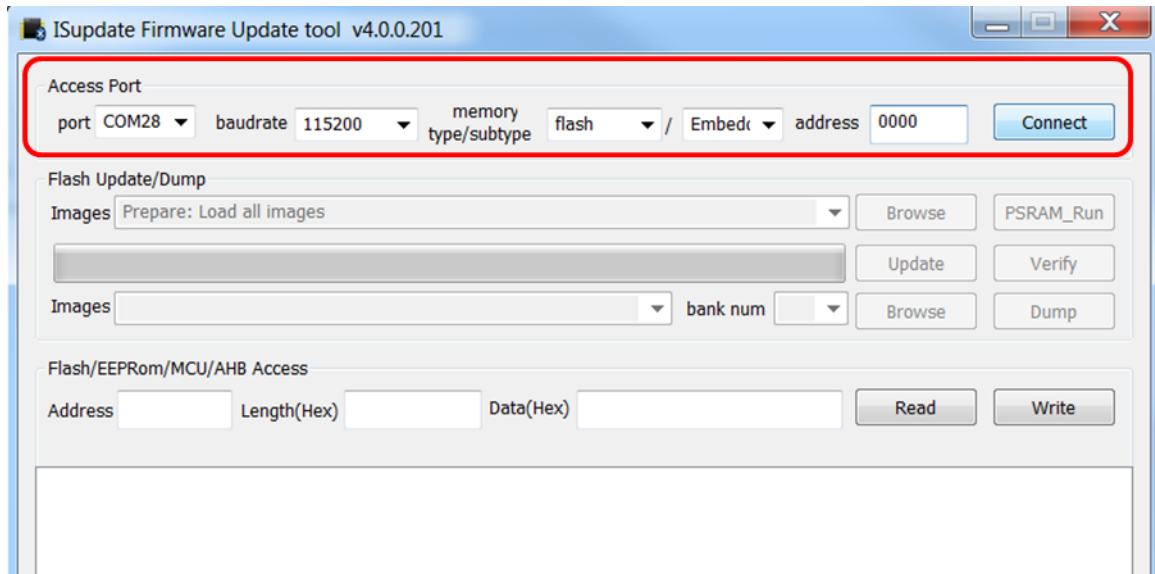

Click **Connect**. If the connection was successful, the application will confirm by printing the following message.

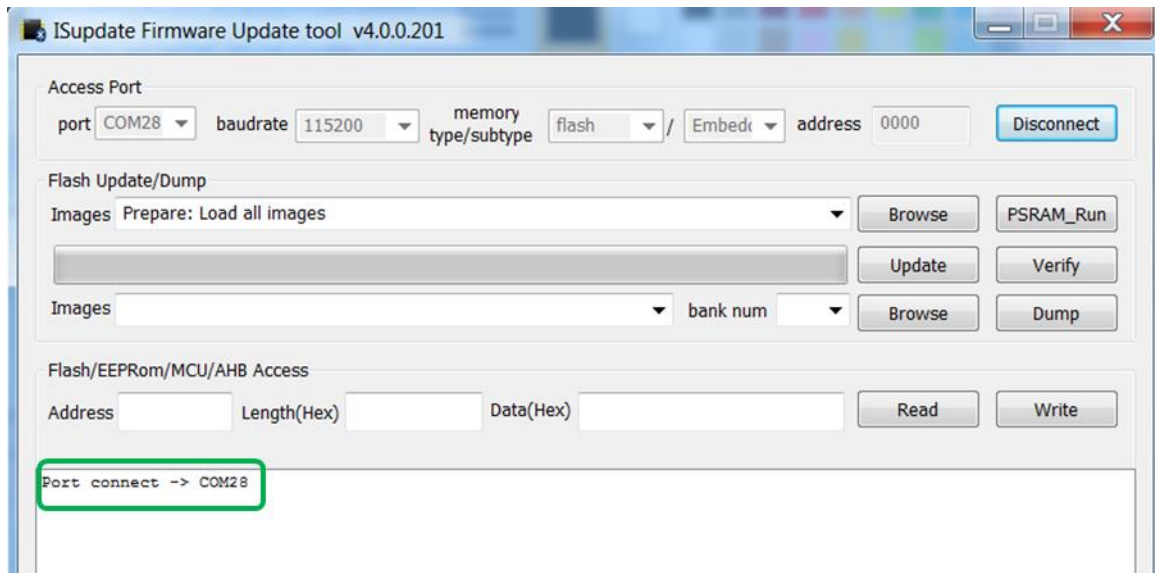

Click the **Browse** button and navigate to the folder where the firmware package was extracted to. Select all hex files and click **Open**.

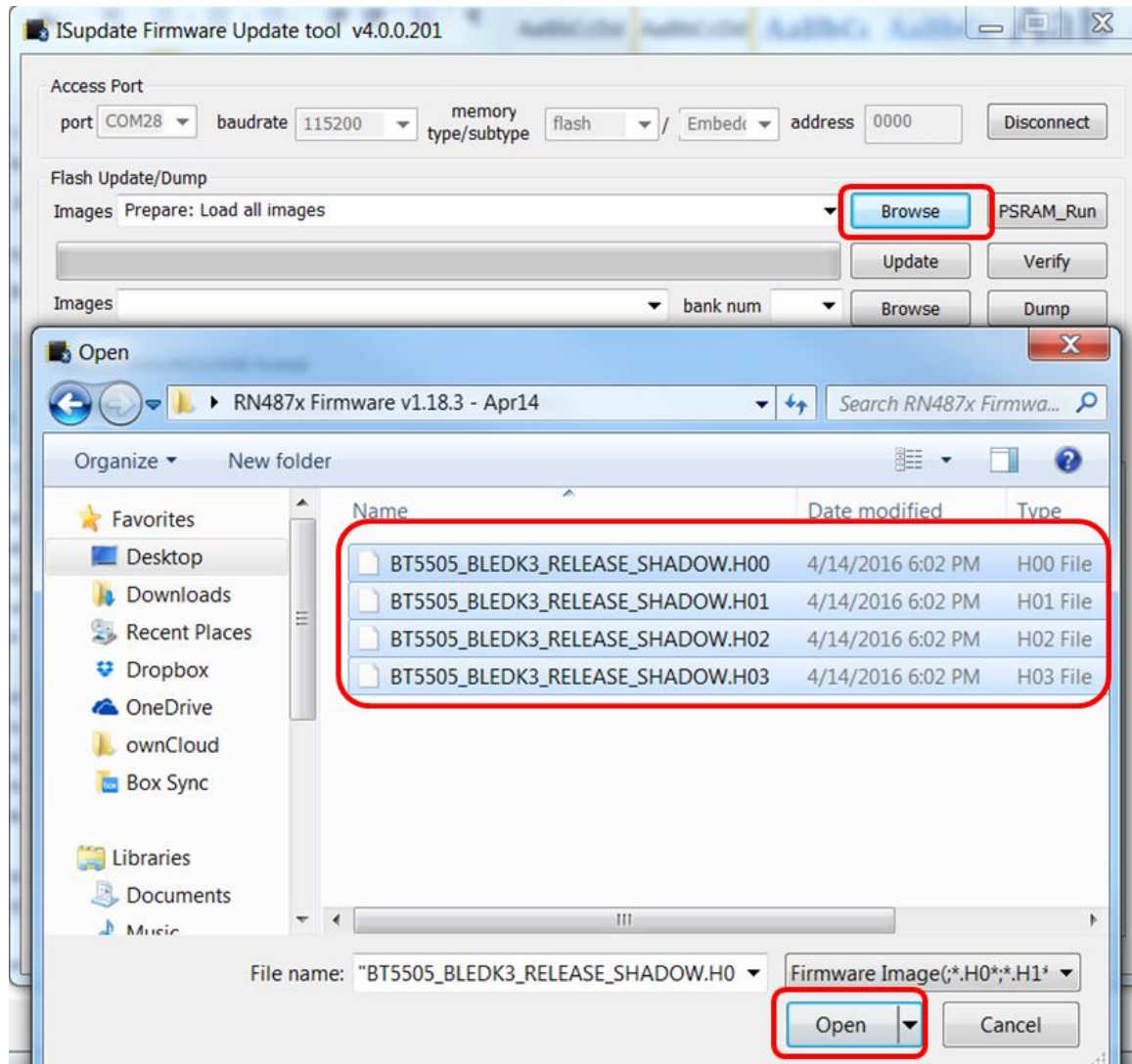

Click **Update**. Allow a few seconds for the update to complete.

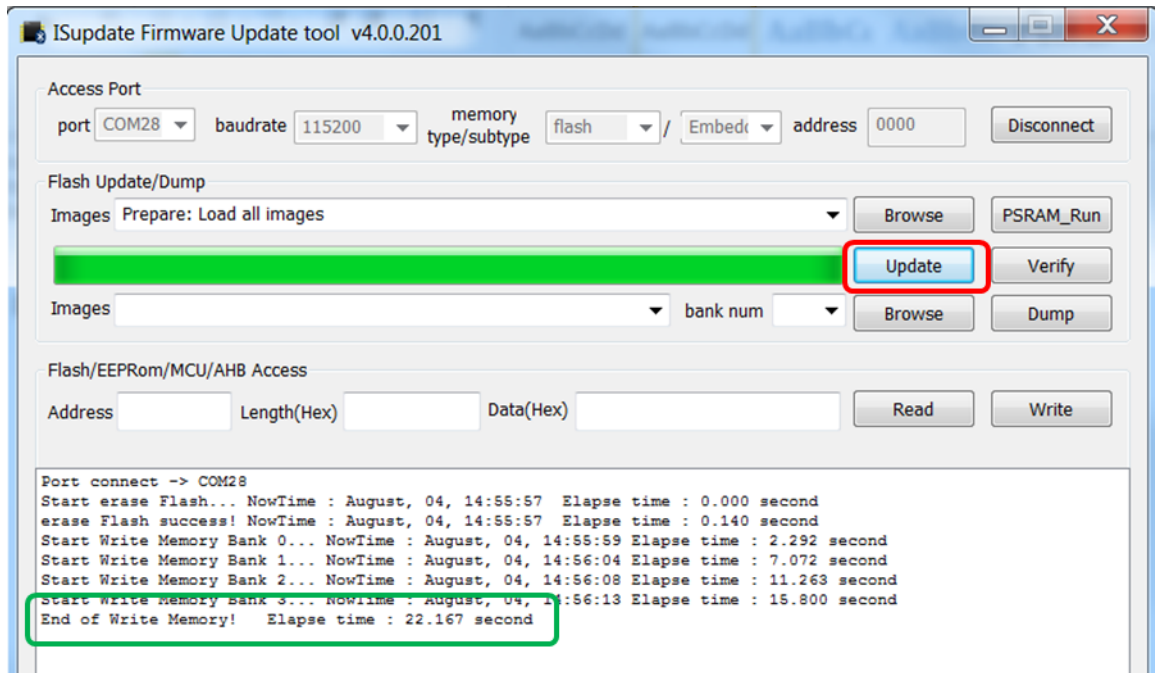

Now you can disconnect and close the ISupdate tool.

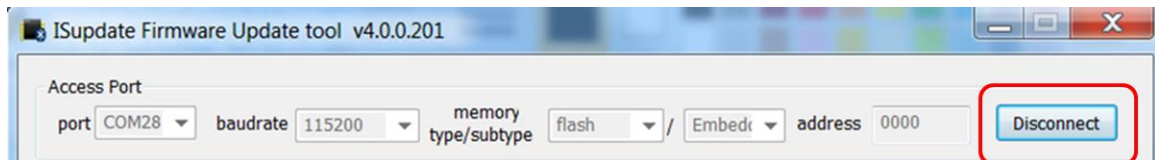

The version of the firmware can be verified by opening a CoolTerm connection.

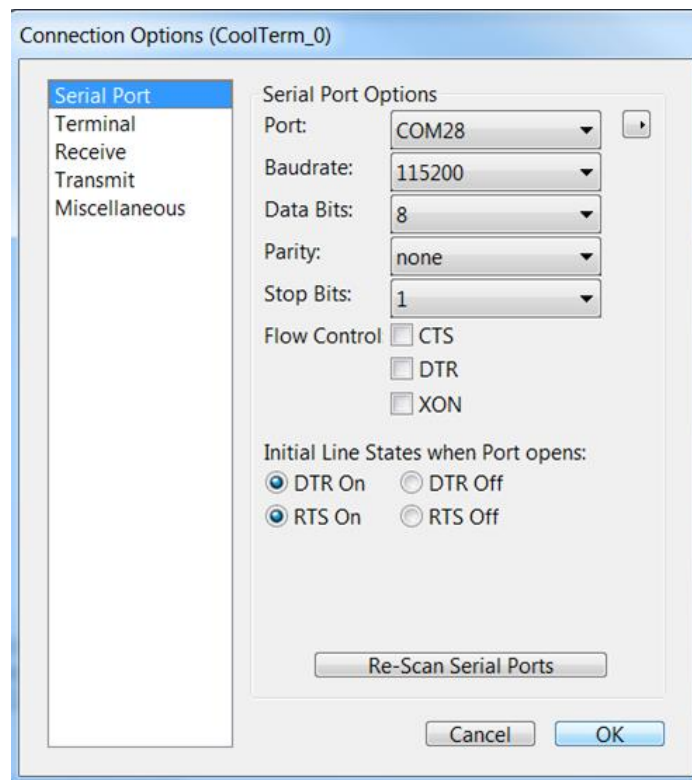

Ensure the details are correct as per the picture, and set to the following:

Baudrate: 115200
Data Bits: 8
Parity: None
Stop Bits: 1
Flow Control: None

In addition, the Local Echo has been turned on in the Terminal tab.

Now, enter the Command Mode and Verify Version using the following steps.

- Press \$ to enter Command Mode
- Press V to display firmware version.

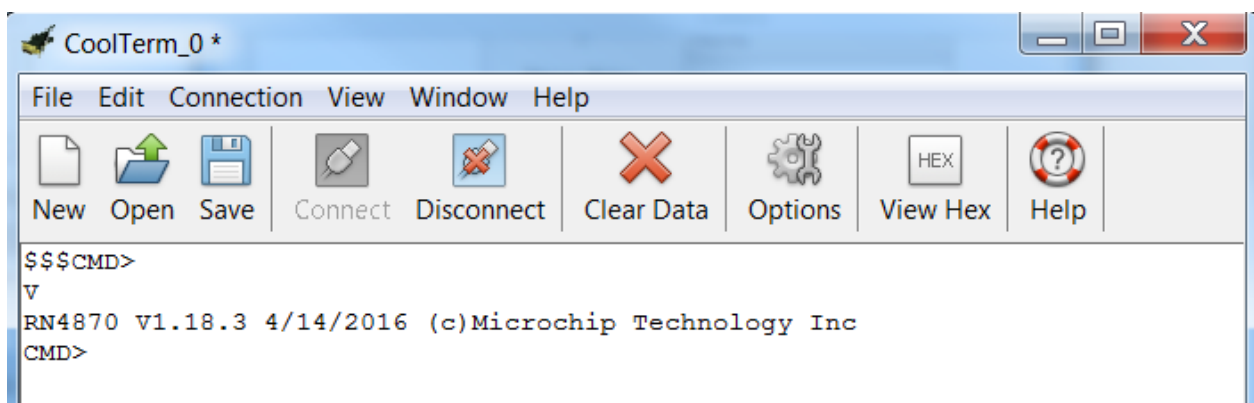

The above confirms that the Bluetooth module has been updated to version 1.18.3 of the firmware.

5.7. Mechanical Views

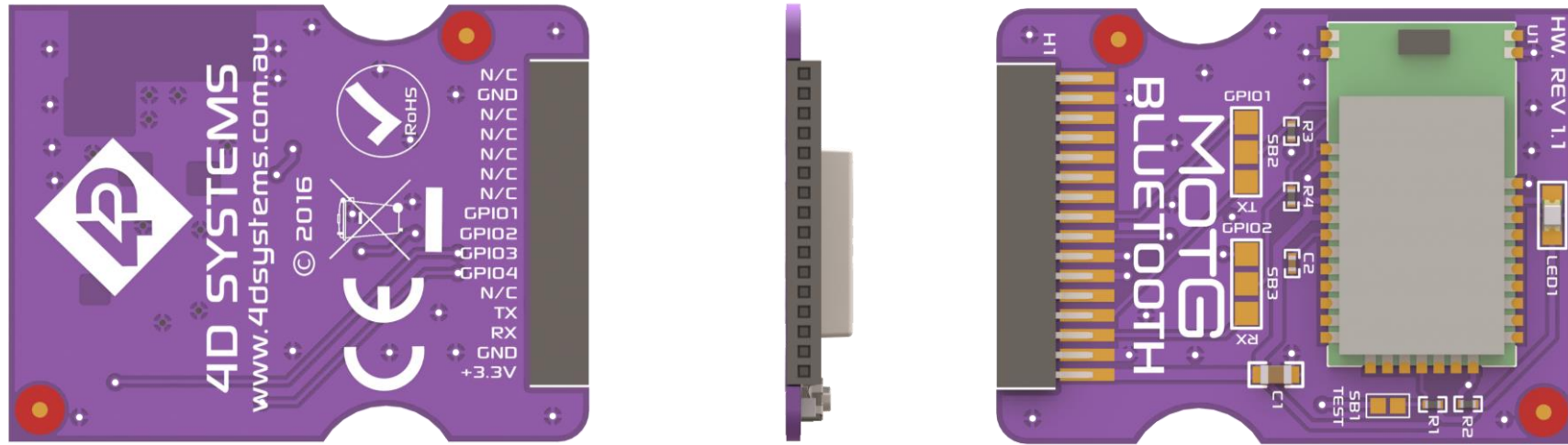

5.8. Schematic Details

MOTG – Modules On The Go Series

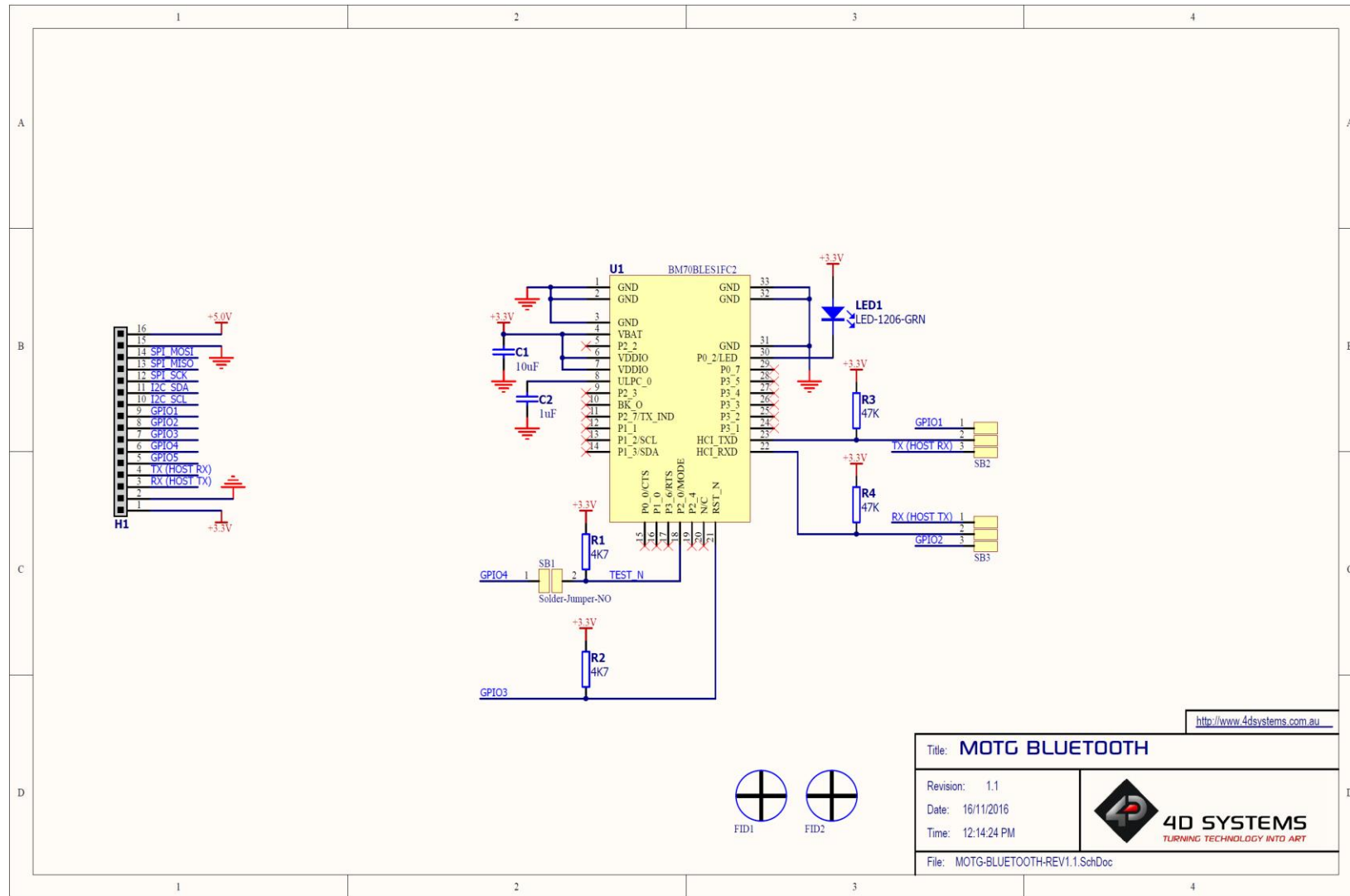

5.9. Specifications

RECOMMENDED OPERATING CONDITIONS

Parameter	Conditions	Min	Typ	Max	Units
Supply Voltage (VCC)	Relative to VSS	1.9	3.3	3.6	V
Operating Temperature		-20.0	--	70.0	°C
Storage Temperature		-65.0		150.0	°C
Input Low Voltage (VIL)	All pins	VSS	--	0.3*VCC	V
Input High Voltage (VIH)	All pins	0.7*VCC	--	VCC	V

GLOBAL CHARACTERISTICS BASED ON OPERATING CONDITIONS

Parameter	Conditions	Min	Typ	Max	Units
Peak Current	TX mode, VCC = 3V, TX = 0 dBm, Buck mode	--	--	13.0	mA
	RX mode, VCC = 3V, Buck mode	--	--	13.0	mA
Standby Current		1.9	--	2.9	uA
Output Low Voltage (VOL)		VSS	--	0.2*VCC	V
Output High Voltage (VOH)		0.8*VCC	--	VCC	V

6. gen4-MOTG-AC1



6.3. Pin Description



6.1. Description

The gen4-MOTG-AC1 Interface Board allows easy interface of a MOTG module to Diablo16-based gen4 display modules. The board carries one UMI-compatible MOTG slot which acts as an extension to the display module providing plug-and-play interface with MOTG.

The interface board is designed to sit flush on the back of the Diablo16 2.4" to 3.5" display modules enabling sleek and compact designs.

It also features a 30 pin ZIF socket, for easy connection to application boards for further functionality advancement.

6.2. Hardware Overview

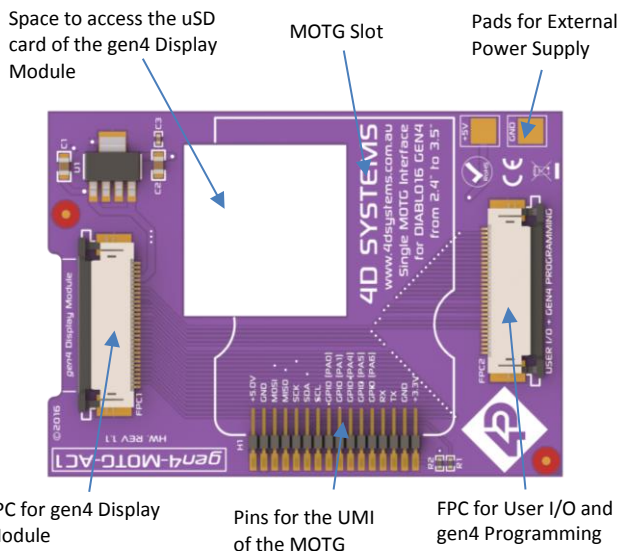

Pin	Symbol	Description
1	3.3V	3.3V Input Supply
2	GND	Supply Ground
3	TX	Asynchronous Serial Receive Pin connected to PA3 of gen4 Display Module
4	RX	Asynchronous Serial Transmit Pin connected to PA2 of the gen4 Display Module
5	GPIO5	General Purpose Input Output Pin connected to PA6 of the Display.
6	GPIO4	General Purpose Input Output Pin connected to PA5 of the Display.
7	GPIO3	General Purpose Input Output Pin connected to PA4 of the Display.
8	GPIO2	General Purpose Input Output Pin connected to PA1 of the Display.
9	GPIO1	General Purpose Input Output Pin connected to PA0 of the Display.
10	SCL	I ² C Clock Pin connected to PA9 of the gen4 Display Module
11	SDA	I ² C Data Pin connected to PA10 of the gen4 Display Module
12	SCK	SPI Clock Pin connected to PA13 of the Display
13	MISO	SPI Master In Slave Out Pin connected to PA11 of the Display
14	MOSI	SPI Master Out Slave In Pin connected to PA12 of the Display
15	GND	Supply Ground
16	5.0V	5V Input Supply

6.4. Accessing pins of MOTG via gen4-PA

Pin	UMI	gen4-PA
	Symbol	Symbol
1	3.3V	NA
2	GND	GND
3	TX	GPIO1 (PA3)
4	RX	GPIO2 (PA2)
5	GPIO5	GPIO8 (PA6)
6	GPIO4	GPIO9 (PA5)
7	GPIO3	GPIO10 (PA4)
8	GPIO2	GPIO3 (PA1)
9	GPIO1	GPIO4 (PA0)
10	SCL	GPIO5 (PA9)
11	SDA	GPIO11 (PA10)
12	SCK	GPIO14 (PA13)
13	MISO	GPIO12 (PA11)
14	MOSI	GPIO13 (PA12)
15	GND	GND
16	5.0V	+5V

6.5. Mechanical Views

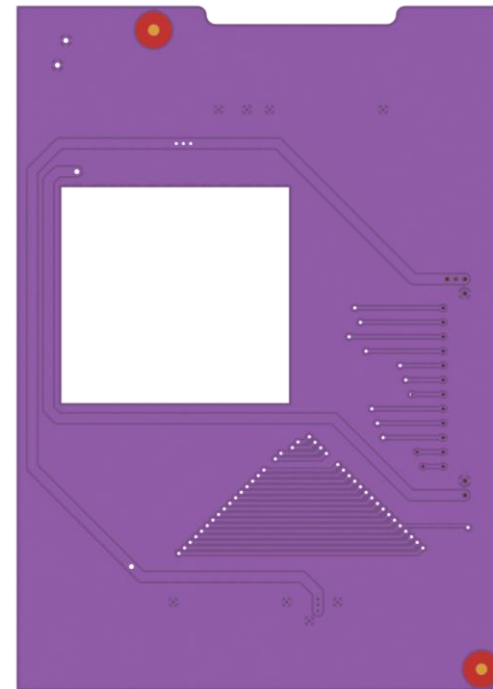
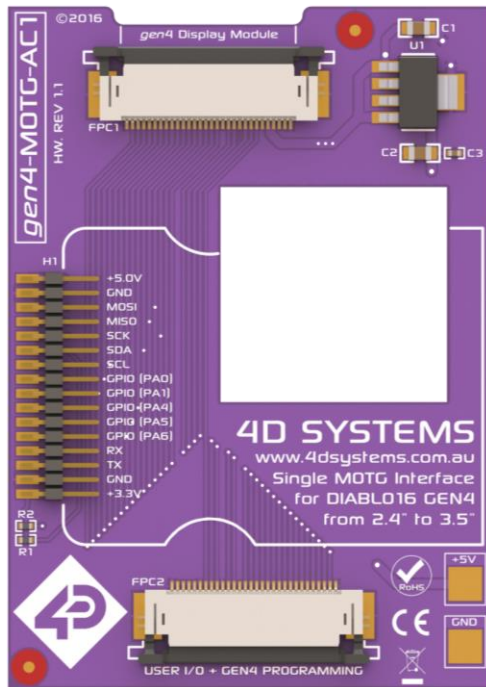

6.6. Schematic Details

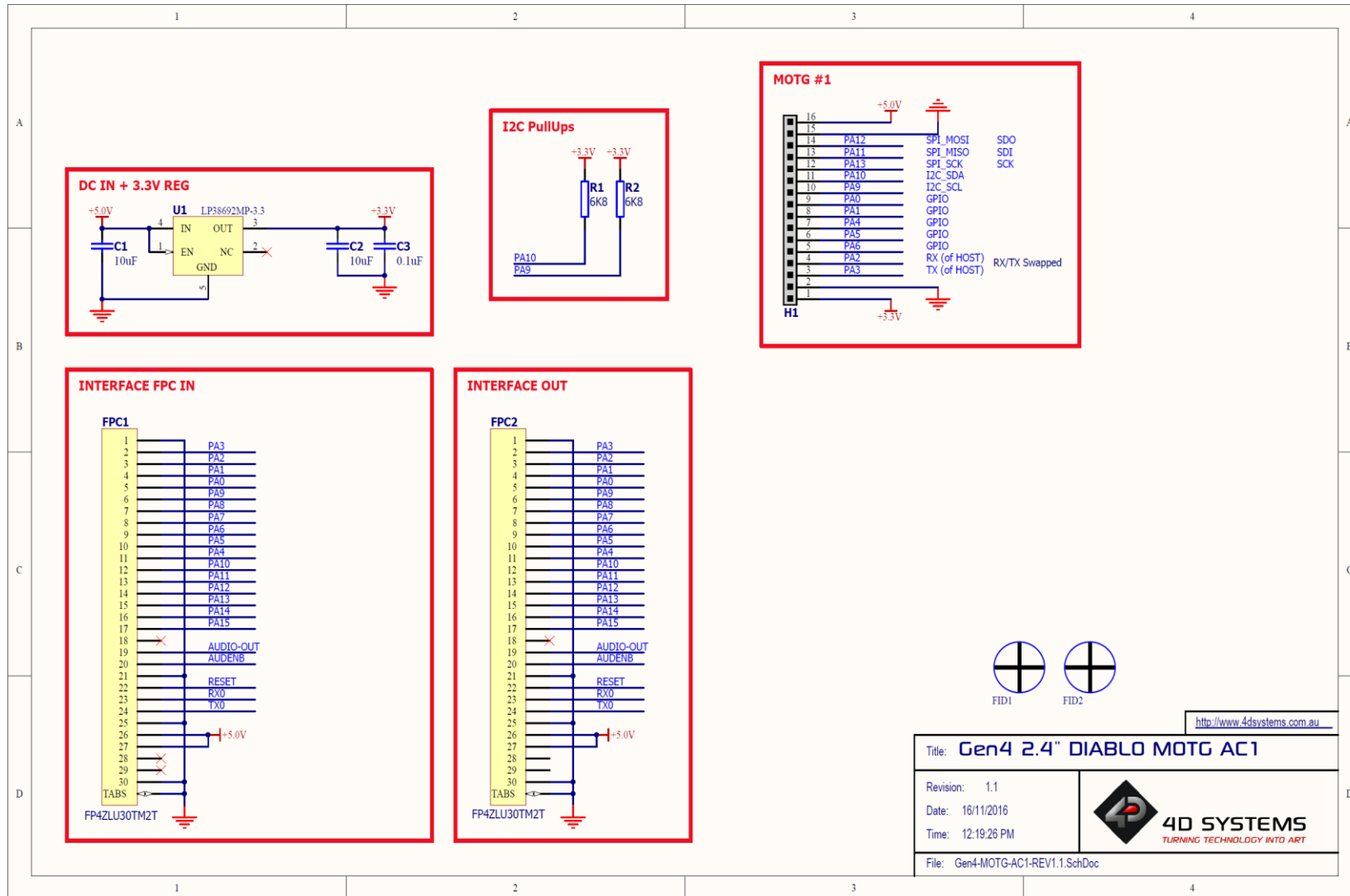

Title: **Gen4 2.4" DIABLO MOTG AC1**

Revision: 1.1
 Date: 16/11/2016
 Time: 12:19:26 PM

File: Gen4-MOTG-AC1-REV1.1.SchDoc

7. gen4-MOTG-AC2



7.3. Pin Description

7.3.1. MOTG Slot #1 Pin Description

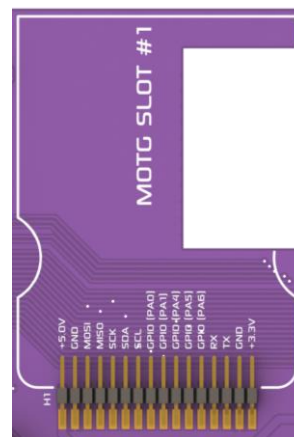

7.1. Description

The gen4-MOTG-AC2 Interface Board allows easy interface of a MOTG module to Diablo16-based gen4 display modules. The board carries two UMI-compatible MOTG slots which act as an extension to the display module providing plug-and-play interface with MOTG.

The interface board is designed to sit flush on the back of the Diablo16 3.2" and 3.5" display modules enabling sleek and compact designs. It also features a 30 pin ZIF socket, for easy connection to application boards for a further functionality advancement.

7.2. Hardware Overview

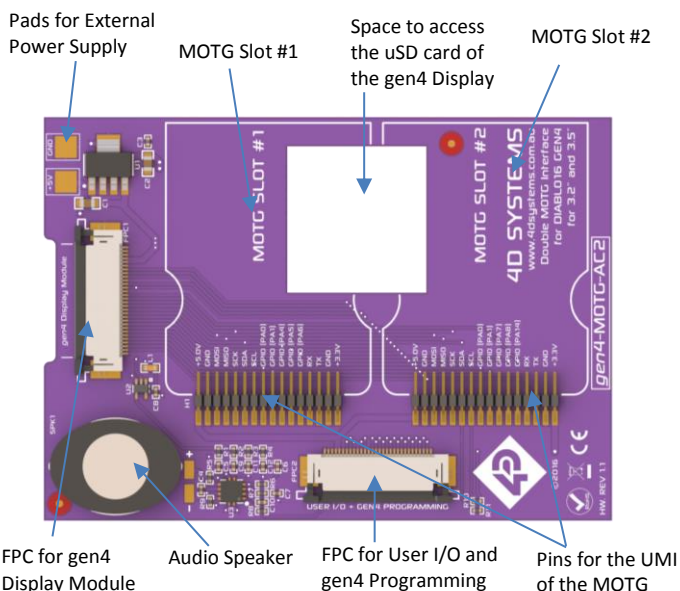

Pin	Symbol	Description
1	3.3V	3.3V Input Supply
2	GND	Supply Ground
3	TX	Asynchronous Serial Receive Pin connected to PA3 of gen4 Display Module
4	RX	Asynchronous Serial Transmit Pin connected to PA2 of the gen4 Display Module
5	GPIO5	General Purpose Input Output Pin connected to PA6 of the Display.
6	GPIO4	General Purpose Input Output Pin connected to PA5 of the Display.
7	GPIO3	General Purpose Input Output Pin connected to PA4 of the Display.
8	GPIO2	General Purpose Input Output Pin connected to PA1 of the Display.
9	GPIO1	General Purpose Input Output Pin connected to PA0 of the Display.
10	SCL	I ² C Clock Pin connected to PA9 of the gen4 Display Module
11	SDA	I ² C Data Pin connected to PA10 of the gen4 Display Module
12	SCK	SPI Clock Pin connected to PA13 of the Display
13	MISO	SPI Master In Slave Out Pin connected to PA11 of the Display
14	MOSI	SPI Master Out Slave In Pin connected to PA12 of the Display
15	GND	Supply Ground
16	5.0V	5V Input Supply

7.3.2. MOTG Slot #2 Pin Description



Pin	Symbol	Description
1	3.3V	3.3V Input Supply
2	GND	Supply Ground
3	TX	Asynchronous Serial Receive Pin connected to PA3 of gen4 Display Module
4	RX	Asynchronous Serial Transmit Pin connected to PA2 of the gen4 Display Module
5	GPIO5	General Purpose Input Output Pin connected to PA14 of the Display.
6	GPIO4	General Purpose Input Output Pin connected to PA8 of the Display.
7	GPIO3	General Purpose Input Output Pin connected to PA7 of the Display.
8	GPIO2	General Purpose Input Output Pin connected to PA1 of the Display.
9	GPIO1	General Purpose Input Output Pin connected to PA0 of the Display.
10	SCL	I ² C Clock Pin connected to PA9 of the gen4 Display Module
11	SDA	I ² C Data Pin connected to PA10 of the gen4 Display Module
12	SCK	SPI Clock Pin connected to PA13 of the Display
13	MISO	SPI Master In Slave Out Pin connected to PA11 of the Display
14	MOSI	SPI Master Out Slave In Pin connected to PA12 of the Display
15	GND	Supply Ground
16	5.0V	5V Input Supply

7.4. Communication

Both slots of the gen4-MOTG-AC2 facilitate communication between the display module and the MOTG modules using UART, SPI or I2C communication protocol. Below are a few tips that might be useful when using 2 MOTG modules with the same communication protocol.

7.4.1. UART

TX (Pin3) and RX (Pin4) of the UMI enable UART communication. However, UART pins for both slots are connected to the same pins of the display modules as shown in section 7.3.

For all MOTG modules requiring UART communication, the hardware is designed to allow the UART pins to be connected to either TX, RX or GPIO1, GPIO2 of the UMI. This is could be achieved by shorting the respective sides of the solder bridges. Hence, one of the MOTGs could use the GPIO1 and GPIO2 pins, while the other could use the TX and RX pins, making serial communication with both MOTG possible.

7.4.2. SPI

SCK (Pin12), MISO (Pin13) and MOSI (Pin14) of the UMI permit SPI communication. The SPI communication pins of both slots are connected to the SPI pins of the gen4 display module. The slave- or chip-select pins could then be utilised by the display module to communicate to a specific MOTG module.

7.4.3. I2C

SCL (Pin10) and SDA (Pin11) of the UMI are responsible for I2C communication. The I2C communication pins of both slots are connected to the I2C pins of the gen4 display module. The host could then select the desired MOTG module by using the correct slave address.

7.5. Accessing MOTG pins via gen4-PA

UMI (MOTG Slot 1)		gen4-PA
Pin	Symbol	Symbol
1	3.3V	NA
2	GND	GND
3	TX	GPIO1 (PA3)
4	RX	GPIO2 (PA2)
5	GPIO5	GPIO8 (PA6)
6	GPIO4	GPIO9 (PA5)
7	GPIO3	GPIO10 (PA4)
8	GPIO2	GPIO3 (PA1)
9	GPIO1	GPIO4 (PA0)
10	SCL	GPIO5 (PA9)
11	SDA	GPIO11 (PA10)
12	SCK	GPIO14 (PA13)
13	MISO	GPIO12 (PA11)
14	MOSI	GPIO13 (PA12)
15	GND	GND
16	5.0V	+5V

UMI (MOTG Slot 2)		gen4-PA
Pin	Symbol	Symbol
1	3.3V	NA
2	GND	GND
3	TX	GPIO1 (PA3)
4	RX	GPIO2 (PA2)
5	GPIO5	GPIO15 (PA14)
6	GPIO4	GPIO6 (PA8)
7	GPIO3	GPIO7 (PA7)
8	GPIO2	GPIO3 (PA1)
9	GPIO1	GPIO4 (PA0)
10	SCL	GPIO5 (PA9)
11	SDA	GPIO11 (PA10)
12	SCK	GPIO14 (PA13)
13	MISO	GPIO12 (PA11)
14	MOSI	GPIO13 (PA12)
15	GND	GND
16	5.0V	+5V

7.6. Mechanical Views

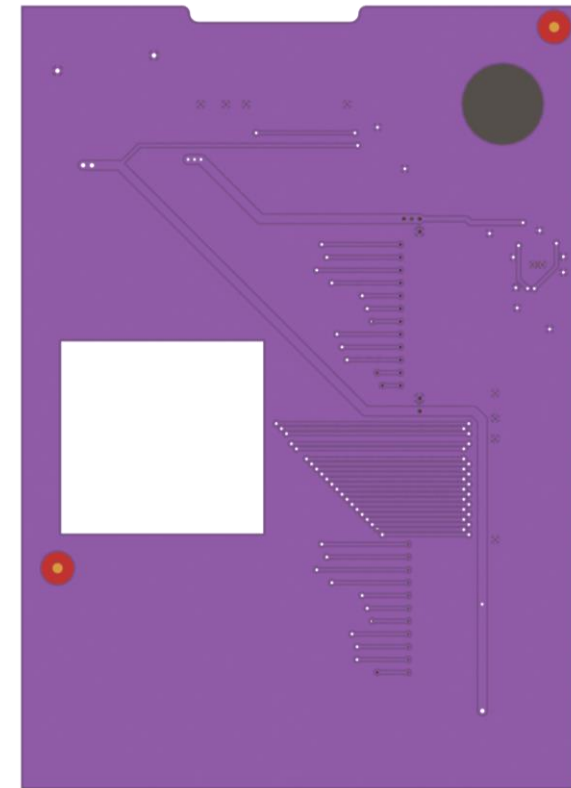
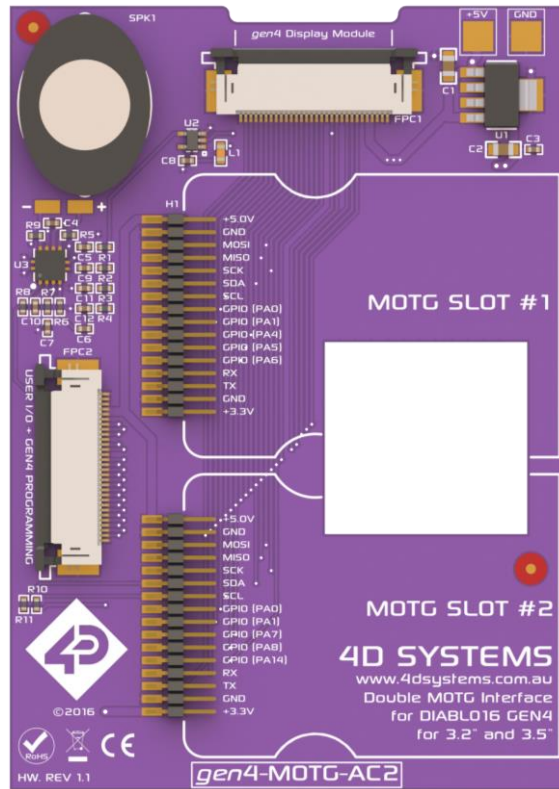

7.7. Schematic Details

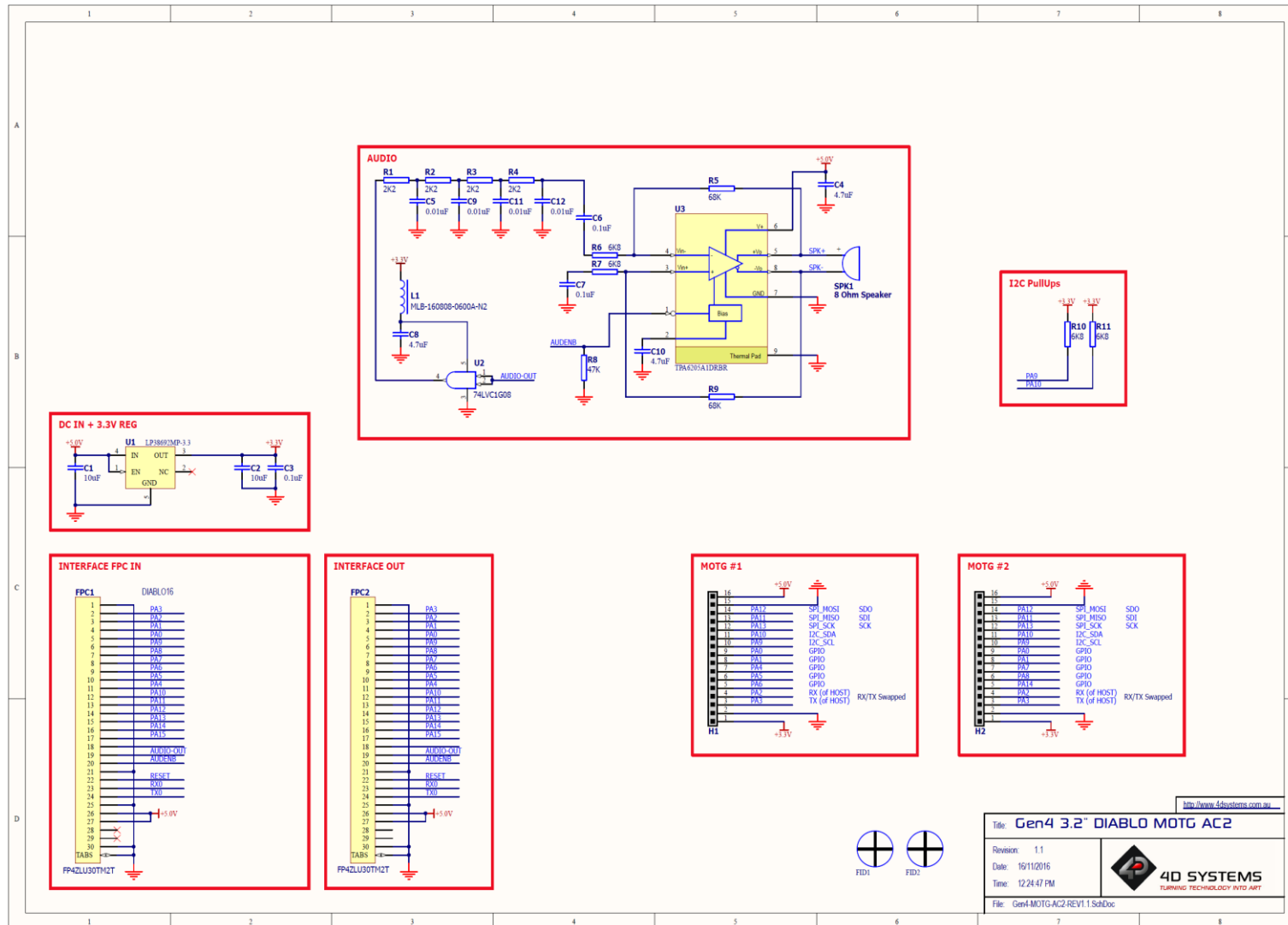

7.8. Specifications

RECOMMENDED CONDITIONS					
Parameter	Conditions	Min	Typ	Max	Units
Supply Voltage		--	5.0	--	V
Supply Current		12.0	--	1500	mA
Operating Temperature		-20.0	--	70.0	°C
Storage Temperature		-65.0	--	150.0	
Audio Pin (PWM)	AUDIO-OUT (Pin 19 FPC)	--	3.3	--	v
Input Low Voltage (VIL)	AUDENB (Pin 20 FPC)	--	--	0.5	V
Input High Voltage (VIH)	AUDENB (Pin 20 FPC)	1.15	--	--	V

8. gen4-MOTG-AC3

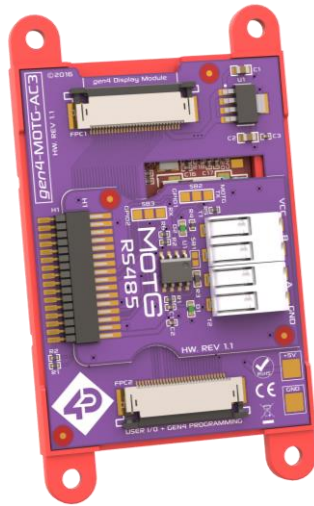

8.3. Pin Description



8.1. Description

The gen4-MOTG-AC3 Interface Board allows easy interface of a MOTG module to Picaso-based gen4 display modules. The board carries one UMI-compatible MOTG slot which acts as an extension to the display module providing plug-and-play interface with MOTG.

The interface board is designed to sit flush on the back of the Picaso 2.4" to 3.2" display modules enabling sleek and compact designs. It also features a 30 pin ZIF socket, for easy connection to application boards for a further functionality advancement.

8.2. Hardware Overview

Space to access the USD card of the gen4 Display Module

MOTG Slot

Pads for External Power Supply

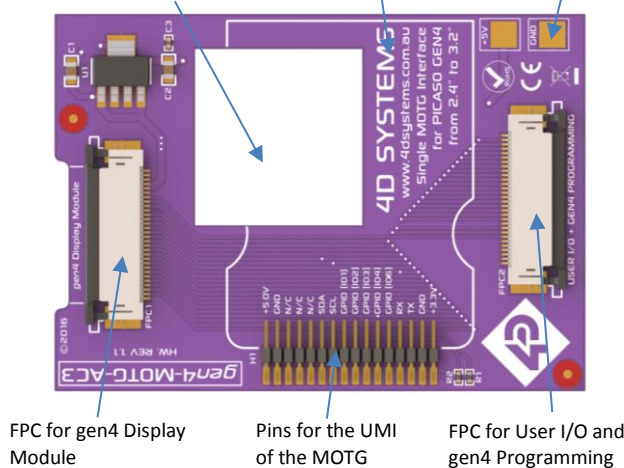

Pin	Symbol	Description
1	3.3V	3.3V Input Supply
2	GND	Supply Ground
3	TX	Asynchronous Serial Receive Pin connected to TX1 of gen4 Display Module
4	RX	Asynchronous Serial Transmit Pin connected to RX1 of the gen4 Display Module
5	GPIO5	General Purpose Input Output Pin connected to IO5 of the Display.
6	GPIO4	General Purpose Input Output Pin connected to IO4 of the Display.
7	GPIO3	General Purpose Input Output Pin connected to IO3 of the Display.
8	GPIO2	General Purpose Input Output Pin connected to IO2 of the Display.
9	GPIO1	General Purpose Input Output Pin connected to IO1 of the Display.
10	SCL	I ² C Clock Pin connected to SCL of the gen4 Display Module
11	SDA	I ² C Data Pin connected to SDA of the gen4 Display Module
12	N/C	No Connect
13	N/C	No Connect
14	N/C	No Connect
15	GND	Supply Ground
16	5.0V	5V Input Supply

8.4. Accessing pins of MOTG via gen4-PA

UMI		gen4-PA
Pin	Symbol	Symbol
1	3.3V	NA
2	GND	GND
3	TX	GPIO15 (TX1)
4	RX	GPIO14 (RX1)
5	GPIO5	GPIO13 (IO5)
6	GPIO4	GPIO4 (IO4)
7	GPIO3	GPIO3 (IO3)
8	GPIO2	GPIO2 (IO2)
9	GPIO1	GPIO1 (IO1)
10	SCL	GPIO16 (SCL)
11	SDA	GPIO17 (SDA)
12	N/C	NA
13	N/C	NA
14	N/C	NA
15	GND	GND
16	5.0V	+5V

8.5. Mechanical Views



8.6. Schematic Details

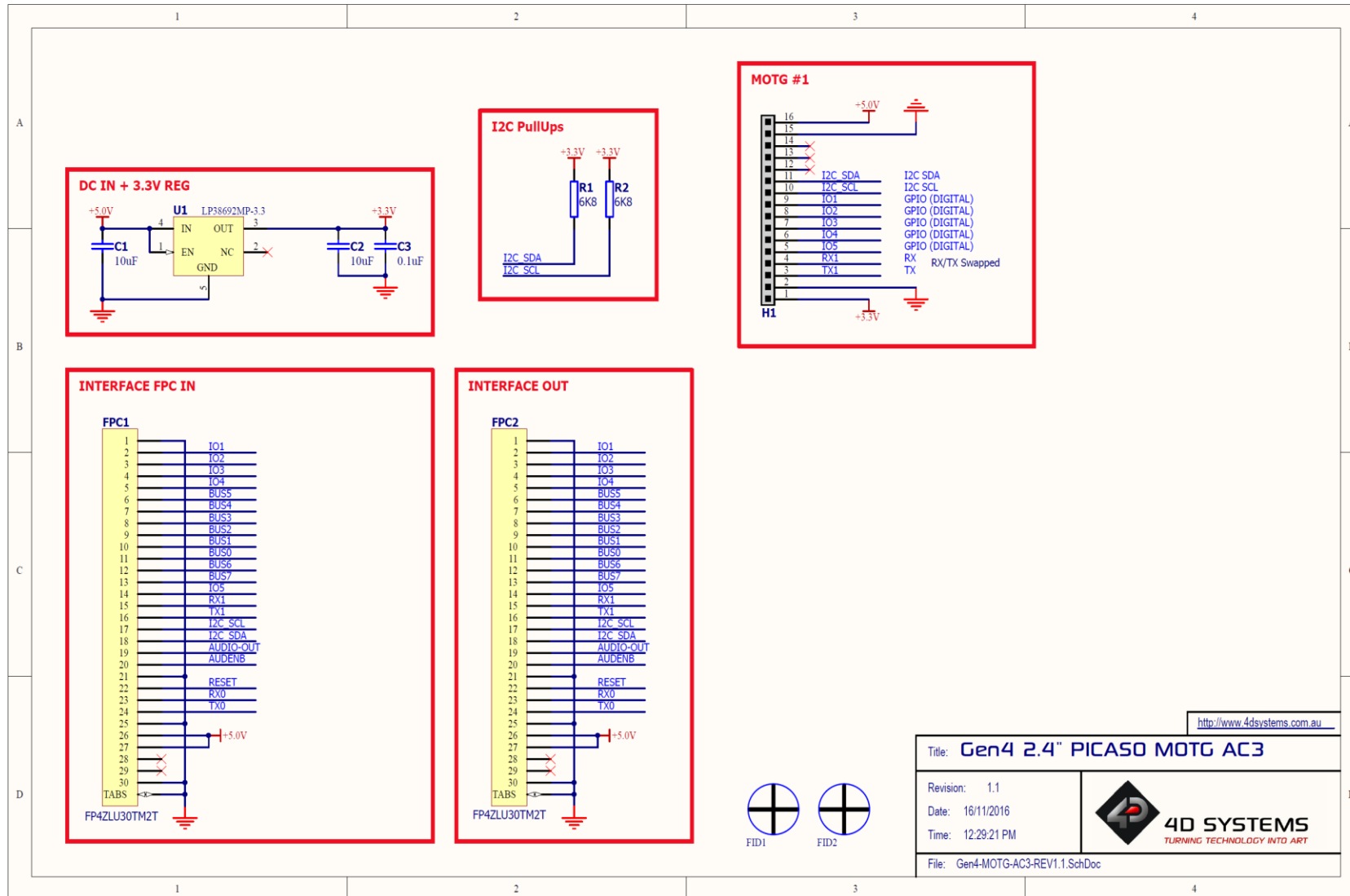

8.7. Specifications

RECOMMENDED CONDITIONS				
Parameter	Min	Typ	Max	Units
Supply Voltage	--	5.0	--	V
Supply Current	10.0	--	1000	mA
Operating Temperature	-20.0	--	70.0	°C
Storage Temperature	-65.0	--	150.0	°C

8.8. Hardware Revision History

Revision Number	Date	Description
1.1	16/11/2016	Initial Public Release version

End of gen4-MOTG-AC3 Datasheet

9. MOTG-BREADTOOTH

9.3. Pin Description

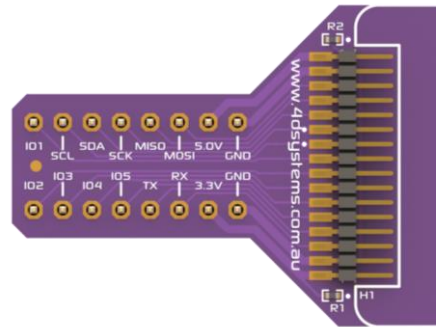
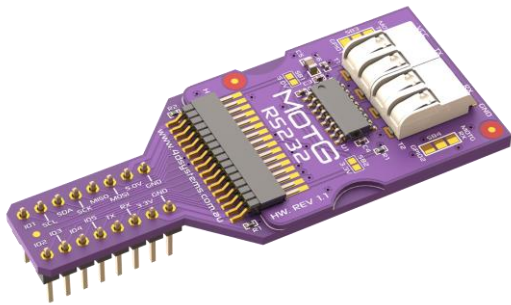

9.1. Description

The MOTG-BREADTOOTH breaks out the UMI pins of the MOTG. It is compatible with all MOTG modules and is a quick and easy way to make your MOTG module breadboard-friendly. The MOTG-BREADTOOTH permits the MOTG to be interfaced to a breadboard for prototyping and for interfacing to virtually any host.

9.2. Hardware Overview

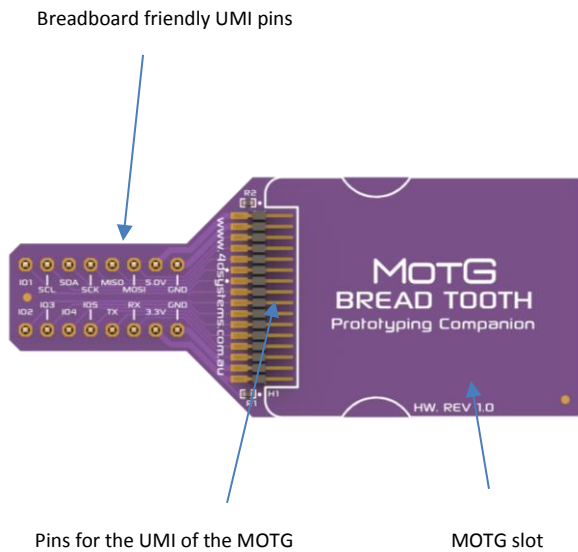

Pin	Symbol	Description
1	GND	Supply Ground connected to GND of the UMI
2	3.3V	3.3V Input Supply connected to 3.3V of the UMI
3	RX	Asynchronous Serial Transmit Pin connected to RX of UMI
4	TX	Asynchronous Serial Receive Pin connected to RX of UMI
5	IO5	General Purpose Input Output Pin connected to GPIO5 of the UMI
6	IO4	General Purpose Input Output Pin connected to GPIO4 of the UMI
7	IO3	General Purpose Input Output Pin connected to GPIO3 of the UMI
8	IO2	General Purpose Input Output Pin connected to GPIO2 of the UMI
9	IO1	General Purpose Input Output Pin connected to GPIO1 of the UMI
10	SCL	I ² C Clock Pin connected to SCL of the UMI
11	SDA	I ² C Data Pin connected to SDA of UMI
12	SCK	SPI Clock Pin connected to SCK of the UMI
13	MISO	SPI Master In Slave Out Pin connected to MISO of the UMI
14	MOSI	SPI Master Out Slave In Pin connected to MOSI of the UMI
15	5.0V	5V Input Supply
16	GND	Supply Ground

9.4. Mechanical Views

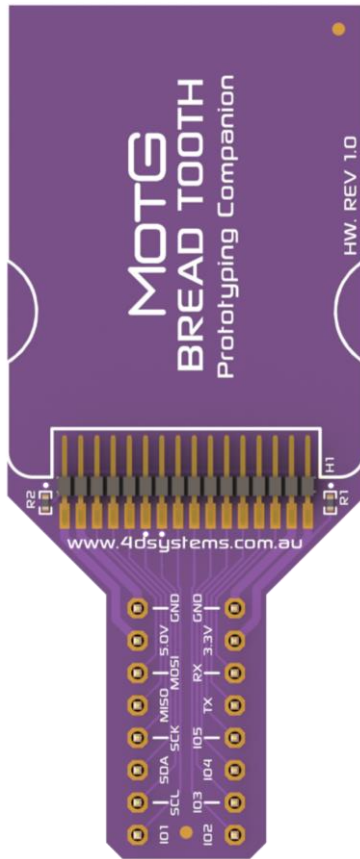

9.5. Schematic Details

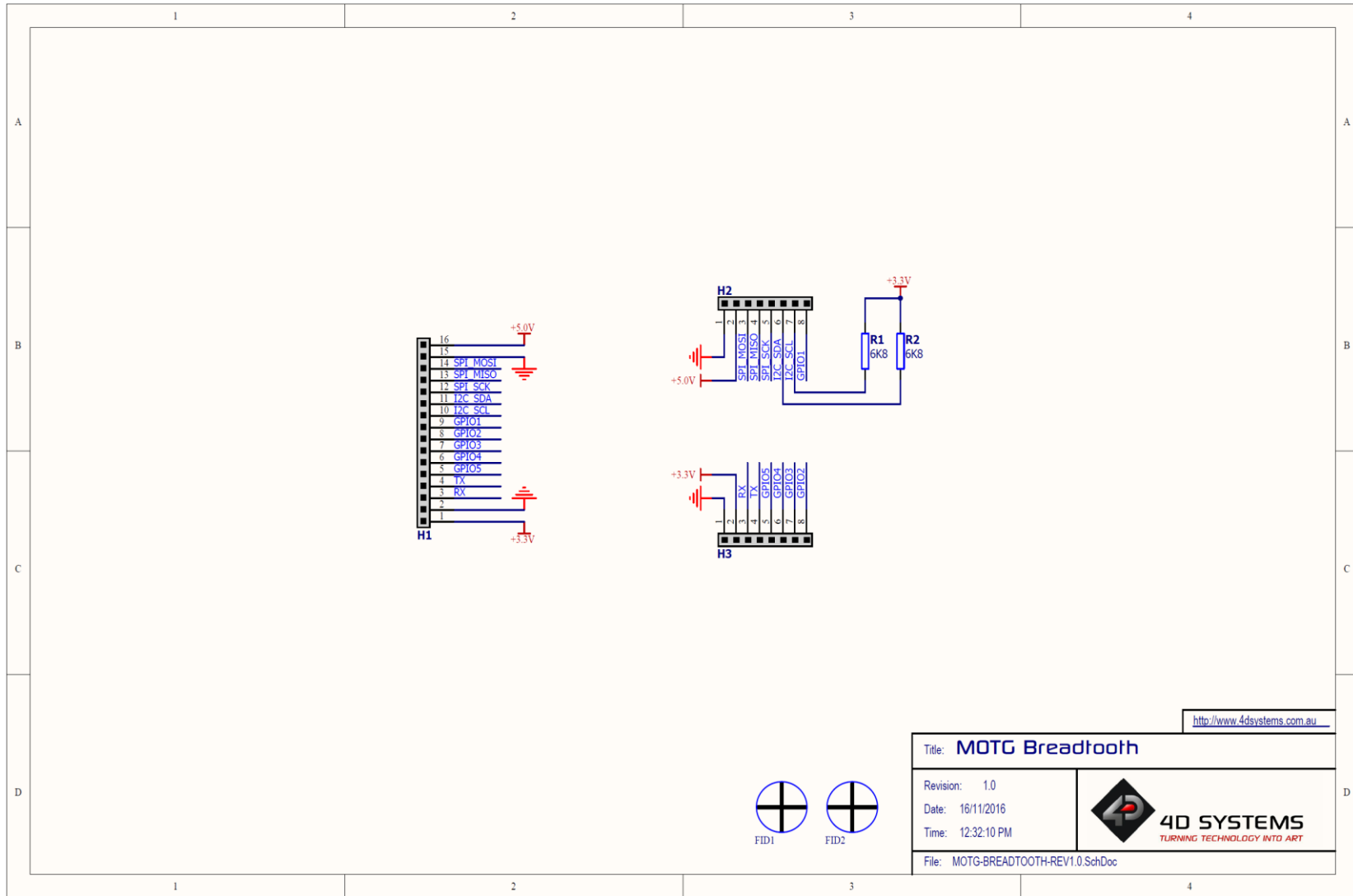

9.6. Hardware Revision History

Revision Number	Date	Description
1.0	16/11/2016	Initial Public Release version

End of MOTG-BREADTOOTH Datasheet

10. Legal Notice

Proprietary Information

The information contained in this document is the property of 4D Systems Pty. Ltd. and may be the subject of patents pending or granted, and must not be copied or disclosed without prior written permission.

4D Systems endeavours to ensure that the information in this document is correct and fairly stated but does not accept liability for any error or omission. The development of 4D Systems products and services is continuous and published information may not be up to date. It is important to check the current position with 4D Systems. 4D Systems reserves the right to modify, update or make changes to Specifications or written material without prior notice at any time.

All trademarks belong to their respective owners and are recognised and acknowledged.

Disclaimer of Warranties & Limitation of Liability

4D Systems makes no warranty, either expressed or implied with respect to any product, and specifically disclaims all other warranties, including, without limitation, warranties for merchantability, non-infringement and fitness for any particular purpose.

Information contained in this publication regarding device applications and the like is provided only for your convenience and may be superseded by updates. It is your responsibility to ensure that your application meets with your specifications.

Images and graphics used throughout this document are for illustrative purposes only. All images and graphics used are possible to be displayed on the 4D Systems range of products, however the quality may vary.

In no event shall 4D Systems be liable to the buyer or to any third party for any indirect, incidental, special, consequential, punitive or exemplary damages (including without limitation lost profits, lost savings, or loss of business opportunity) arising out of or relating to any product or service provided or to be provided by 4D Systems, or the use or inability to use the same, even if 4D Systems has been advised of the possibility of such damages.

4D Systems products are not fault tolerant nor designed, manufactured or intended for use or resale as on line control equipment in hazardous environments requiring fail – safe performance, such as in the operation of nuclear facilities, aircraft navigation or communication systems, air traffic control, direct life support machines or weapons systems in which the failure of the product could lead directly to death, personal injury or severe physical or environmental damage ('High Risk Activities'). 4D Systems and its suppliers specifically disclaim any expressed or implied warranty of fitness for High Risk Activities.

Use of 4D Systems' products and devices in 'High Risk Activities' and in any other application is entirely at the buyer's risk, and the buyer agrees to defend, indemnify and hold harmless 4D Systems from any and all damages, claims, suits, or expenses resulting from such use. No licenses are conveyed, implicitly or otherwise, under any 4D Systems intellectual property rights.

11. Contact Information

For Technical Support: www.4dsystems.com.au/support

For Sales Support: sales@4dsystems.com.au

Website: www.4dsystems.com.au

Copyright 4D Systems Pty. Ltd. 2000-2017.