

Control Switches and Signaling Devices and Signaling Devices

22.5 mm Plastic Series

Control Switches and Signaling Devices, 22.5mm Plastic Series	300
Non-Illuminated Operators, 22.5mm Plastic Series	302
Illuminated Operators, 22.5mm Plastic Series	304
Pilot Lights and Lens Assemblies, 22.5mm Plastic Series	305
Control Switches and Signaling Devices, 22.5mm Plastic Series	306



Airpax Corporation
807 Woods Road
Cambridge, Maryland
21613 USA
Tel: 410-228-1500
Fax: 410-228-3456
infopp@airpax.net

AIRPAX
www.airpax.net

Control Switches and Signaling Devices, 22.5mm Plastic Series

This range of 22.5mm plastic series pushbuttons, selector switches, illuminated switches and pilot lights have been designed to provide the following features:

- Economy of space
- Self wiping contacts
- Safe in operation
- Simple to mount (only need a screw driver)
- Mounting method is unaffected by excessive vibration
- Electric shock protection (grounded unit)
- Aesthetically pleasing
- Heavy-duty construction
- Shrouded terminals
- Very good flame resistance
- Use of LEDs for long life

Actuators

The circular actuators have black plastic bezels and are functionally interchangeable on the different contact elements.

Contact elements

The contact elements are double break and have self-wiping contacts. The elements are interchangeable and can be stacked without additional hardware. 1 to 6 elements (NO or NC) can be used for non-illuminated actuators, whereas, 1 to 4 elements (NO or NC) can be used for illuminated actuators. Gold NO or NC contact elements for low voltage, low current, < 25mA, switching applications are available.

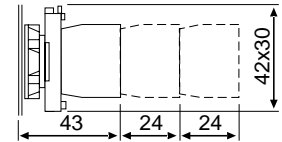

Illuminated pushbuttons and pilot lights

Pilot lights and pushbutton switches are suitable for direct connection through a series resistor, series resistor and diode, using bayonet cap filament bulb type BA9s as follows:

- Supply voltage for direct connection without series resistor 6V - 130V
- Supply voltage through series resistor 12V - 415V
- Supply voltage through resistor and diode 230 VAC
- Bulb Filament, type BA9s with OAL max. 28mm

Pilot lights and illuminated actuators are available with integral LEDs, suitable for operating at various voltages; 6V, 12V, 24V, 30V, 48V, 63.3V, 110V, 125V, 230VAC or DC and 415VAC. Pilot lights and illuminated actuators are available with LED bulbs (bayonet cap, BA9s design with OAL max. 28mm) suitable for operating at various voltages; 24V, 110V and 230V. On request an extra short circuit protection consisting of built-in fuse in the LED modules can be provided. Pilot lights are available with built -in transformers suitable for operating at 110VAC, 230VAC input and 6V, 12V and 24V output.

Terminals

Contact elements and pilot lights are designed to have shrouded terminals with combination screws.

Mounting

The plastic series control devices 22.5mm can be mounted in any position on panels of 1 to 5 mm thickness. We recommend minimum mounting centers of 30mm x 40mm. However, the dimensions and configuration should be decided on the basis of the application. The actuators and the lens assemblies lock on the holding bracket. See assembly details.

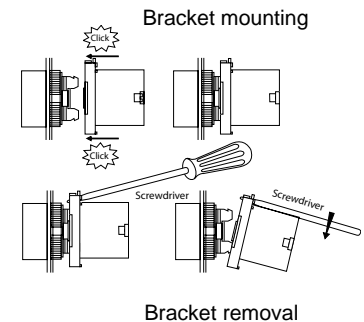
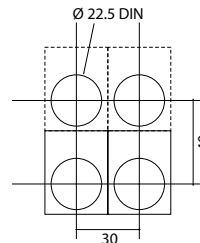

Electrical and mechanical characteristics

- Environment
- Standards conformity: CSA - C22.2 No. 14-95, UL508, EN60947-5-1 2000
- Approvals: CSA - C22.2 No. 14-95, UL508, VDE0660
- Degree of protection: IP 65 as per IEC529, NEMA 4X, 12 as per UL50
- Ambient temperature: -25°C to +70°C
- Operating position: All positions

Contact block

- Rated insulation voltage: 500V
- Rated thermal current: 10A
- Contact operation: Self wiping, slow break NO or NC
- Make and break capacity as per IEC 947-5-(1) 1990: AC 15 - 4A, 415VAC; DC 13 - 0.5A, 110VDC
- Terminal capacity: Minimum 1 X 0.5mm², minimum 2 x 15mm², or 1 x 2.5mm²
- Terminals marking: 1-2 for NC, 3-4 for NO
- Short circuit protection: 10A cartridge fuse, HRC type, rated for resistive loading
- Mechanical life: Over one million operations
- Electrical rating (one million operating cycles at 3600 cycles per hour, load factor 0.5)

AC15	V	24	120	230	DC13	V	24	110
	A	4	3	2		A	0.5	0.2

Modules for pilot lights and illuminated switches with integral LED / LED bulb (BA9S cap)

Current consumption (applicable to all colors)

- 24VAC/DC, 110VAC and 240VAC: max. 20mA
- 110VDC: max. 15mA
- 220VDC: max. 10mA
- Service life (at nominal voltage and at ambient temperature): 100,000 hours
- Voltage limits (nominal voltage): <20% of rated voltage>
- Short circuit protection: on specific request
- Terminal capacity: min. 1 X 0.5mm², max. 2 x 1.5mm² or 1 x 2.5mm²

Control Switches and Signaling Devices, 22.5mm Plastic Series

Ordering Information

1. Actuators, illuminated actuators, contact elements, lens assemblies and pilot lights are each ordered separately. For complete assemblies, please contact the factory for specific part numbers.

2. Prefix ASP2 for all actuators indicates 22.5 plastic series

3. The type numbers of contact elements are:

NO	Actuator mounting	S1, S3	Note: S3, S4, S7, and S8 have gold plated contact suitable for low voltage, low current applications <25mA
	Individual mounting	S5, S7	
NC	Actuator mounting	S2, S4	
	Individual mounting	S6, S8	

4. Part number examples:

Actuator	ASP2AF3	= flush actuator, green
Pilot light	ASP2PLB4	= pilot light without series resistor, red

Accessories and spares

Legend plates

Legend plates 30 x 40 mm are supplied with the following standard text:

START UP OPEN AUTO SLOW RESET ON RIGHT FORWARD TRIP
STOP DOWN CLOSE HAND FAST INCH OFF LEFT REVERSE POWER ON

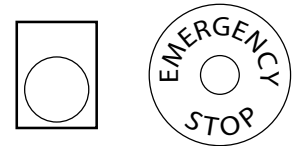

Replacement bulbs

Filament Bulb type ABA9S, OAL 28mm

Voltage:	6	12	24	30	48	60	130
Watts:	1	2	2	2	2	2	2.6

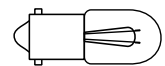

LED bulb type BA9S, OAL 28mm

Color:	White	Green	Red	Amber	Blue	Yellow	V	W
P/N:	AMCB9124	AMCB9324	AMCB9424	AMCB9524	AMCB9624	AMCB9824	24	0.5
	AMCB91110	AMCB93110	AMCB94110	AMCB95110	AMCB96110	AMCB98110	110	1.0
	AMCB91230	AMCB93230	AMCB94230	AMCB95230	AMCB96230	AMCB98230	230	1.0

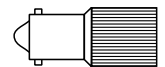

Lenses

Lens color:	Translucent	Green	Red	Amber	Blue	Clear	Yellow
White							
For pilot lights w/filament bulb	AP2PLL1	AP2PLL3	AP2PLL4	AP2PLL5	AP2PLL6	AP2PLL7	AP2PLL8
For illuminated actuators w/filament bulb	AP2LAL1	AP2LAL3	AP2LAL4	AP2LAL5	AP2LAL6	AP2LAL7	AP2LAL8
For pilot lights w/ LED	AP2PLL1L	AP2PLL3L	AP2PLL4L	AP2PLL5L	AP2PLL6L	AP2PLL7L	AP2PLL8L
For illuminated actuators w/LED	AP2LAL1L	AP2LAL3L	AP2LAL4L	AP2LAL5L	AP2LAL6L	AP2LAL7L	AP2LAL8L

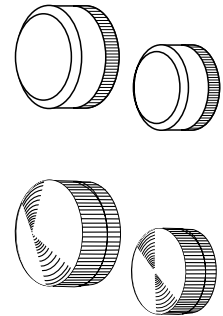

Adaptor
For mounting 22.5mm devices into 30.5mm cutout
Part number: A2ADP

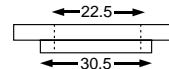

Mounting Bracket: AP2BRK

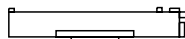

Padlock
Mushroom actuator: A2PAM
Projecting actuator: A2PAP



Boot
For non-illuminated flush actuator

A2BT7



For flush/projecting illuminated actuator

A2ALBT7



For twin actuator

A2ATBT7



For twin illuminated actuator

A2ATLBT7

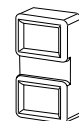

Bulb extractor

A2BA9SE



Hole plug
22.5mm, black

A2BP2





Operator Type

Flush

Flush Booted

Projecting

Mushroom 40mm with Key

Airpax device, plastic, 22.5mm

A S P 2 A F 4 B T 7

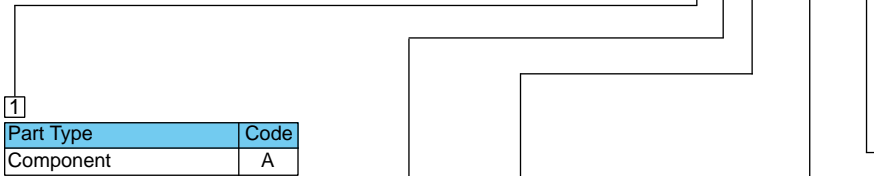

Part Type	Code
Component	A

Operator Type	Code
Flush	F
Flush - booted*	F
Projecting	P
Mushroom - 40mm with key	MLKB
Mushroom - 40mm spring return	M
Mushroom - 40mm push/pull	MPP
Mushroom - 40mm latching w/arrow indicator	ML
Mushroom - 30mm latching w/arrow indicator	MLS
Mushroom - 40mm latching trigger w/arrow indicator	MLT
Mushroom - 40mm latching trigger w/key	MLTKB
Jumbo mushroom - 60mm spring return	MJ
Jumbo mushroom - 60mm push/pull	MJPP
Jumbo mushroom 60mm latching w/arrow indicator	MLJ
Selector w/key**‡	K
Selector***‡	S
Extended selector***‡	S
Twin††	T

* Must select BT7 from decision 4
 ** Selector available in black only
 † Must select E from decision 4
 †† Please select flush or projecting, available in standard green/red color combination
 ‡ Must select an option from decision 5

Operator Color	Code
White	1
Black*	2
Green	3
Red	4
Amber	5
Blue	6
Yellow	8

* Selector is available in black only

Options (see note)	Code
Booted (flush actuator only)	BT7
Extended (selector actuator only)	E

Note: Except for Selector types or a flush boot option, your order number is complete after decision 3. However, if a Selector type is required, please continue with the remaining decisions. If a flush boot is required your part number is complete after decision 4



Note:
Mounting bracket is included.
However, see tables 1 & 2 to order contact elements separately

Decision 5 is required only when a "Selector" type actuator is selected from decision 2.

Key Selector Functions	Key Removal			Code
	Left	Center	Right	
Maintained	✓		✓	2PB
Maintained	✓			2PO
Maintained			✓	2PI
Spring return	✓			2POSR
Maintained	✓		✓	3PB
Maintained	✓	✓	✓	3PA
Maintained		✓		3PC
Spring return		✓		3PSR
Spring return		✓		3PSRL
Spring return			✓	3PSRR
Selector & Extended Selector Functions				Code
Maintained				2P
Spring return				2PSR
Maintained				3P
Spring return				3PSR
Spring return				3PSRL
Spring return				3PSRR



Mushroom 40mm



Mushroom 30mm Latching with arrow indicator



Mushroom 40mm Latching trigger type



Jumbo Mushroom 60mm

Spring Return Push Pull Latching w/ Arrow Indicator

With Arrow Indicator With Key

Spring Return Push Pull Latching w/ Arrow Indicator

Operator Type



Selector with Key



Selector



Extended Selector



Twin



Note:
Up to six contact elements can be installed on any non-illuminated operator
Up to four contact elements can be installed on any illuminated operator

Table 1:

Contact Element	Actuator Mounting	Figure Number	Gold Contacts	Diagram
1NO	S1	1		
1NC	S2	1		
1NO+1NC	S1+S2	2 or 3		
2NO	S1+S1	2 or 3		
2NC	S2+S2	2 or 3		
2NO+2NC	S1+S1 S2+S2	4		
3NO+3NC	S1+S1+S1 S2+S2+S2	5		
1NO	S3	1	⊗	
1NC	S4	1	⊗	

Table 2: Contact element assembly variations for non-illuminated and illuminated pushbuttons. NO is supplied in green and NC is supplied in red. Order elements with P/N's S1 for (NO), S2 for (NC), S3 for (NO, gold contacts), etc. Contact elements S5, S6, S7 and S8 have the mounting screw reversed (see fig. 6 & 7) for mounting to a back panel or wall and cannot be ordered as a complete assembly.

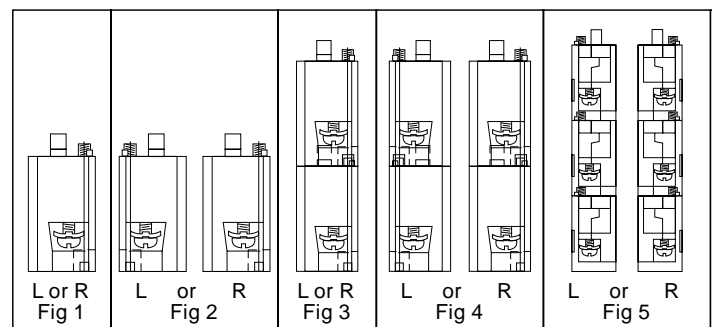

Operator Type



Twin



Flush



Projecting

Bulb Holder Bracket Options



Filament Bulb



Integral LED (RL)



LED Bulb (LB)

Airpax device, plastic, 22.5mm

A S P 2 A L F 4 R L 24

1

Part Type	Code
Component	A

2

Illumination Type	Code
Standard Illuminated Device	L
Illuminated Twin ^{††}	TL

^{††} Please select flush or projecting actuator, available with standard amber lens and green/red color combination. If selecting Integral LED or LED Bulb the illumination code must be placed before the operator code. (i.e. ASP2ATL5LBF3F4 is twin, LED bulb illuminated, amber lens, flush, green and flush, red)

3

Optional	Code
No resistor	
Limiting resistor	R

4

Operator Type	Code
Flush	F
Projecting	P

5

Operator Color	Code
White	1
Black	2
Green	3
Red	4
Amber	5
Blue	6
Clear	7
Yellow	8

8

Connection (table 3)							
Select Illumination Voltage (AC/DC)*							
	12	24	48	110	130	230	415
Filament bulb direct	x	x	x	x	x		
Filament bulb resistor/diode				x	x		
Integral LED**	x	x	x	x		x	x
LED bulb		x	x		x		

* Select one voltage, i.e. 24.
** If voltage is above 110, please indicate AC or DC at end of part number

6

Holder Bracket*	Code
Filament bulb	
Integral LED	RL
LED bulb	LB

* Illuminated devices are supplied with a filament bulb holder unless another option is selected. Filament and LED bulbs must be ordered separately

Pilot Light Type



Pilot Light



Optional pilot light transformer



Economy pilot light with integral LED

Airpax device, plastic, 22.5mm

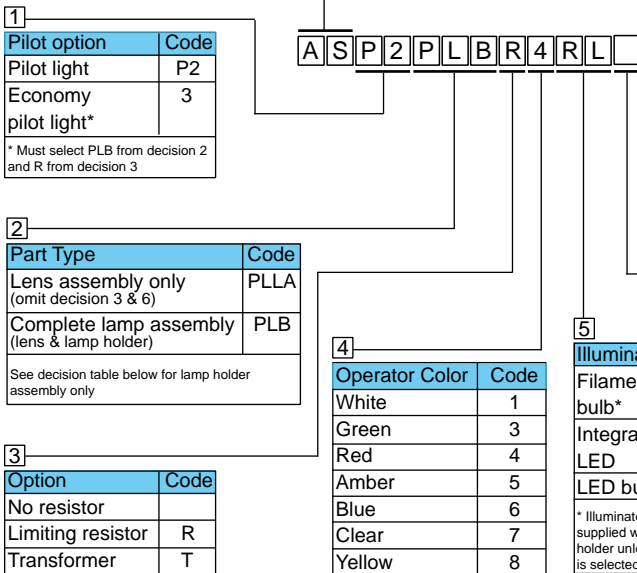

Bulb Holder Bracket Options



Filament Bulb Integral LED (RL) LED Bulb (LB)

Airpax device, plastic, 22.5mm lamp holder assembly ONLY

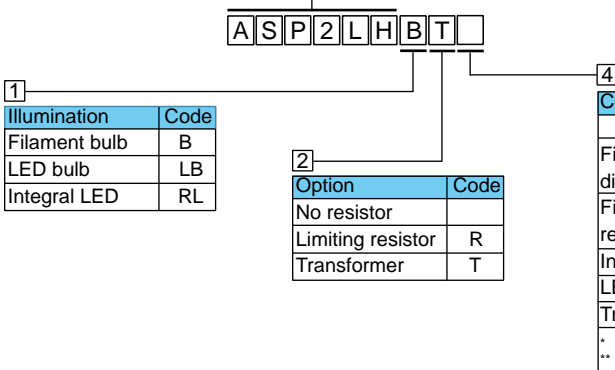
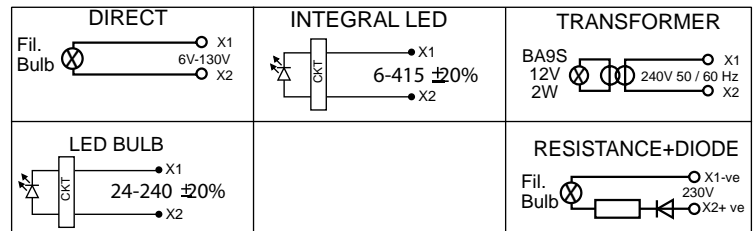

Table 3:



Control Switches and Signaling Devices, 22.5mm Plastic Series

Common order number examples of control and signaling 22.5mm plastic devices

Description	Actuator or lens assembly	Actuator or lens color	Complete assembly order number
Flush pushbutton	ASP2AF3 ASP2AF8	Green Yellow	
Projecting pushbutton	ASP2AP2 ASP2AP4	Black Red	
Booted pushbutton	ASP2AF3BT7 ASP2AF4BT7	Green Red	
Mushroom pushbutton spring return	ASP2AM2 ASP2AM4	Black Red	
Mushroom pushbutton latching with arrow	ASP2AML2 ASP2AML4	Black Red	
Mushroom pushbutton latching with key	ASP2AMLKB4	Red	
Selector (2 position) Selector (3 position)	ASP2AS22P ASP2AS23P	Black Black	
Key Selector (2 position) key removeable in both positions	ASP2AK22PB	Black	
Key Selector (3 position) key removeable in left and right positions	ASP2AK23PB	Black	
Twin pushbutton marked "I O" flush - flush	ASP2ATF2F4IO	Flush - Black Flush - Red	
Twin pushbutton unmarked flush - projecting	ASP2ATF3P4	Flush - Green Projecting - Red	
Flush illuminated pushbutton with integral LED for 24VDC	ASP2ALRF3L24DC	Green	
Flush illuminated pushbutton with integral LED for 230VAC	ASP2ALRF4L230AC	Red	
Twin illuminated pushbutton, marked "I O" flush - flush direct connect up to 130V	ASP2ATL3F2F4IO130	Lens - Green Flush - Black Flush - Red	
Pilot light for direct connect up to 130V	ASP2PLL3 ASP2PLL4	Green Red	ASP2PLB3130 ASP2PLB4130
Pilot light with resistor and diode for 230VAC bulb 130V	ASP2PLL5 ASP2PLL6	Amber Blue	ASP2PLBR5230AC ASP2PLBR6230AC
Pilot light with transformer for 230V, bulb 24V	ASP2PLL4 ASP2PLL3	Red Green	ASP2PLBT4230/24 ASP2PLBT3230/24
Pilot light with LED bulb for 110VAC	ASP2PLL5L	Amber	ASP2PLB5LB110
Pilot light economy type with integral LED for 220VDC	—	White	AS3PLBR1RL220DC

