





# SMT POWER INDUCTORS

## Shielded Drum Core - PL94XX Series



-  **Height:** 0.132 inches (3.35mm) Max
-  **Footprint:** 0.410 inches x 0.410 inches (10.4mm x 10.4mm) Max
-  **Inductance Range:** 0.67μH to 325μH
-  **Current Rating:** up to 7.00A

### Electrical Specifications @ 25°C — Operating Temperature -55°C to +130°C

Part Numbers	Inductance @ I <sub>rated</sub> (μH TYP)	I <sub>rated</sub> <sup>2</sup> (A)	DCR (mΩ)		Inductance @ 0A <sub>DC</sub> (μH)	Saturation <sup>3</sup> Current (A) @ 25°C	Heating <sup>4</sup> Current (A)
			TYP	MAX			
PL9401	0.67	7.00	3.4	4.4	0.68*	7.00	13.00
PL9402	1.3	6.10	4.9	6.4	1.5*	6.10	9.30
PL9403	2.1	5.70	8.0	10.4	2.2*	5.70	7.40
PL9404	3.1	4.80	12.0	15.6	3.3*	4.80	5.90
PL9405	4.5	4.10	16.3	21.2	4.7*	4.10	5.00
PL9406	5.8	3.60	19.4	25.2	6.2*	3.60	4.50
PL9407	7.0	3.30	21.4	27.8	6.8*	3.30	4.15
PL9408	9.4	3.00	30.4	39.5	8.2*	3.00	3.50
PL9409	11	2.70	33.0	42.9	10	2.70	3.25
PL9410	12	2.40	37.0	50.0	12	2.40	2.85
PL9411	15	2.25	48.3	65.2	15	2.25	2.65
PL9412	24	1.85	63.8	86.1	22	1.85	2.25
PL9413	35	1.40	93	126	33	1.40	1.85
PL9414	48	1.25	139	188	47	1.25	1.45
PL9415	55	1.15	154	208	56	1.15	1.35
PL9416	64	1.05	207	279	68	1.05	1.20
PL9417	88	0.94	235	317	82	0.94	1.08
PL9418	106	0.88	265	358	100	0.88	1.00
PL9419	129	0.80	354	478	120	0.80	0.93
PL9420	157	0.70	404	545	150	0.70	0.83
PL9421	238	0.58	620	837	220	0.58	0.75
PL9422	325	0.45	888	1199	330	0.45	0.73

\*Inductance at 0A<sub>DC</sub> tolerance on indicated part numbers is ±30%; tolerance is ±20% on all other parts. Optional Tape & Reel packaging can be ordered by adding a "T" suffix to the part number (i.e. PL9401 becomes PL9401T).

**NOTES FROM TABLE:** (See back page)

## Mechanical

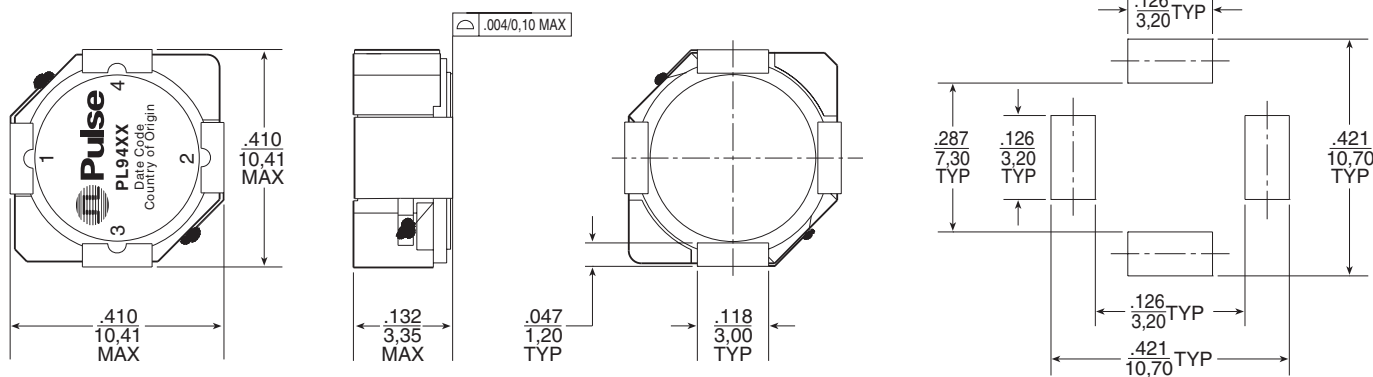

**NOTE:** Pin 3 and Pin 4 are for mechanical connection only.

**SUGGESTED PAD LAYOUT**

# SMT POWER INDUCTORS

## Shielded Drum Core - PL94XX Series



### Notes from Tables

1. Temperature of the component (ambient plus temperature rise) must be within specified operating temperature range.
2. The rated current as listed is either the saturation current or the heating current depending on which value is lower.
3. The saturation current is the current which causes the inductance to drop to 75% of its initial inductance at zero bias. This current is determined by placing the component at room ambient (25°C), and applying a short duration pulse current (to eliminate self-heating effects) to the component.
4. The heating current is the DC current, which causes the temperature of the part to increase by approximately 40°C. This current is determined by extending the terminals of the component with 30mm length 28 gauge buss wires and applying the current to the device for 30 minutes. The temperature is measured by placing the thermocouple between the winding and the shield.
5. In high volt\*time applications, additional heating in the component can occur due to core losses in the inductor which may necessitate derating the current in order to limit the temperature rise of the component. In order to determine the approximate total loss (or temperature rise) for a given application, both copper losses and core losses should be taken into account.

### Schematic

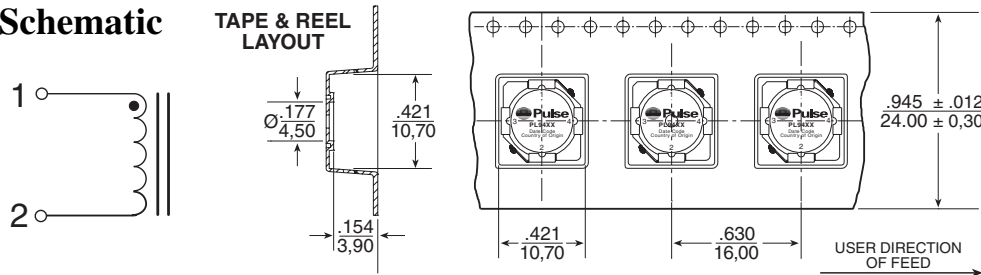

Weight . . . . . 1.5 grams  
 Tape & Reel . . . . . 400/reel  
 Dimensions:  $\frac{\text{Inches}}{\text{mm}}$   
 Unless otherwise specified,  
 all tolerances are  $\pm \frac{.010}{0.25}$

### Inductance vs Current Characteristics

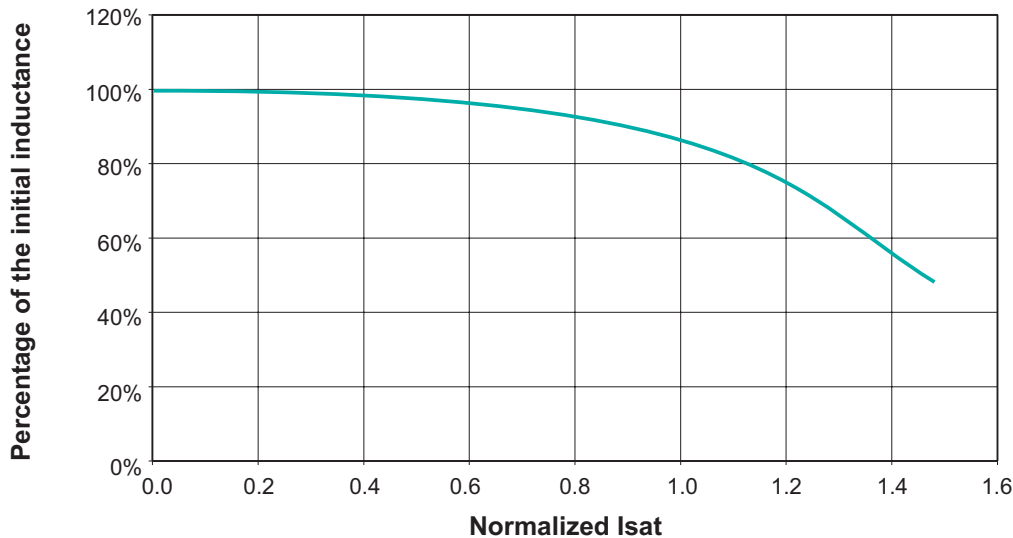

### For More Information:

**Pulse Worldwide Headquarters**  
 2 Pearl Buck Court  
 Bristol, PA 19007  
 U.S.A.  
[www.pulseeng.com](http://www.pulseeng.com)

**Pulse European Headquarters**  
 Einsteinstrasse 1  
 D-71083 Herrenberg  
 Germany

**Pulse China Headquarters**  
 B402, Shenzhen Academy of  
 Aerospace Technology Bldg.  
 10th Kejinan Rd.  
 High-Tech Zone  
 Nanshan District  
 Shenzhen, PR China 518057

**Pulse North China**  
 Room 1503  
 XinYin Building  
 No. 888 YiShan Rd.  
 Shanghai 200233  
 China

**Pulse South Asia**  
 150 Kampong Ampat  
 #07-01/02  
 KA Centre  
 Singapore 368324

**Pulse North Asia**  
 No. 26  
 Kao Ching Rd.  
 Yang Mei Chen  
 Taoyuan Hsien  
 Taiwan, R. O. C.  
 32667

Tel: 215 781 6400  
 Fax: 215 781 6403

TEL: 49 7032 7806 0  
 FAX: 49 7032 7806 12

TEL: 86 755 33966678  
 FAX: 86 755 33966700

TEL: 86 21 32181071  
 FAX: 86 21 32181396

TEL: 65 6287 8998  
 FAX: 65 6280 0080

TEL: 886 3 4643715  
 FAX: 886 3 4641911

Performance warranty of products offered on this data sheet is limited to the parameters specified. Data is subject to change without notice. Other brand and product names mentioned herein may be trademarks or registered trademarks of their respective owners. © Copyright, 2008. Pulse Engineering, Inc. All rights reserved.