

## POWER COMBICON plugs with a 10.16 mm pitch

### PC 16/...-ST(F)-10,16

---

You want to conveniently and economically transfer 76 amps with a 16 mm<sup>2</sup> conductor and a plug connector to your PCB? No problem!

The new PC 16 family offers this connection data with a compact pitch of 10.16 mm with UL voltage of 600 V. As with all POWER COMBICON products, the integrated double steel spring also ensures maximum contact reliability, even in the event of extreme power or temperature fluctuations. The silver-plated metals ensure a constant surface quality with unchanging connection and disconnection forces.

PC 16 is available with 2 to 9 positions and the conductors are screw connected in accordance with the proven tension sleeve principle. A screw flange for securing the connection of the plug to the header is also included in the PC 16 range.

**Note:**

**The PC 16 plugs are compatible with the PC 6-16 headers.**

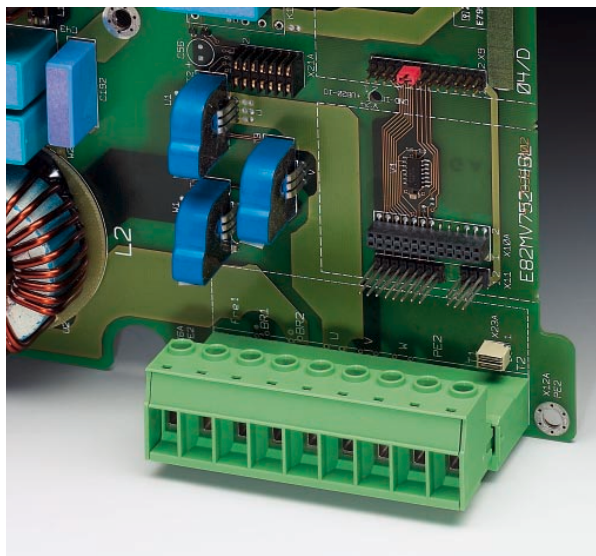

The inverted PC 16 products (see Supplement Catalogue 2004 or data sheet IPC 16/...) also permit

- A touch-proof PCB output
- A free-hanging connection with two plugs, and
- Pluggable connections between individual PCBs.

PC 16 - Power electronics go pluggable and easy to service.

#### COMBICON Select

The COMBICON search engine with CAD downloading





COMBICON Select – the printed circuit board connection software supports your workflow from the PCB and housing layout to the ordering process with:

- Systematic and fast selection of products
- Universal Internet aided engineering with extensive CAD downloading
- Easy-to-use e-shopping functions.

[select.phoenixcontact.com/combicon](http://select.phoenixcontact.com/combicon)

**POWER COMBICON plugs**  
**PC 16/...-ST-10,16**  
**10.16 mm Pitch**



Description	No. of pos.	Dim. a [mm]	Type	Order No.	Pcs./Pkt.
<b>POWER COMBICON plugs, 10.16 mm pitch, color: green</b>	2	10.16	<b>PC 16/2-ST-10,16</b>	<b>19 67 37 5</b>	50
	3	20.32	<b>PC 16/3-ST-10,16</b>	<b>19 67 38 8</b>	
	4	30.48	<b>PC 16/4-ST-10,16</b>	<b>19 67 39 1</b>	
	5	40.64	<b>PC 16/5-ST-10,16</b>	<b>19 67 40 1</b>	
	6	50.80	<b>PC 16/6-ST-10,16</b>	<b>19 67 41 4</b>	
	7	60.96	<b>PC 16/7-ST-10,16</b>	<b>19 67 42 7</b>	
	8	71.12	<b>PC 16/8-ST-10,16</b>	<b>19 67 43 0</b>	
	9	81.28	<b>PC 16/9-ST-10,16</b>	<b>19 67 44 3</b>	
	(1) <b>Coding profile</b> , is inserted into the slot on the plug and header, red insulating material			<b>CP-HCC 4</b>	
(2) <b>Screwdriver</b> , blade: 1.0 x 4.0 x 100 mm, length: 200 mm			<b>SZS 1,0 x 4,0</b>	<b>12 05 06 6</b>	10
(3) <b>Marker card</b> , with 10 pcs., 10-section marker strips, white self-adhesive, for 100 terminal blocks			<b>SK 10/5</b> (see COMBICON catalog)		
(4) <b>Crimping pliers</b> , for ferrules up to 16 mm <sup>2</sup>			<b>CRIMPFOX 16 S</b>	<b>12 07 98 3</b>	1

**Technical data**

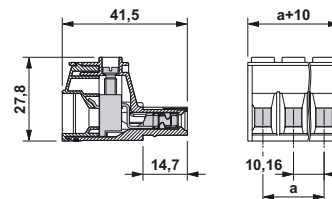

Dimensions		see description		
Pitch	[mm]	10.16		
Hole diameter	[mm]	—		
Pin dimensions	[mm]x[mm]	—		
<b>Technical data in acc. with IEC/ DIN VDE</b>				
Insulating material group	—		I	
Surge voltage category / contamination class	—/—	III / 3	III / 2	II / 2
Rated voltage	[V]	1000	1000	1000
Rated surge voltage	[kV]	8	8	6
Nominal current / cross section	[A]/[mm <sup>2</sup> ]		76 <sup>1)</sup> / 16	
Maximum load current / cross section	[A]/[mm <sup>2</sup> ]		76 <sup>1)</sup> / 16	
<b>Connection capacity</b>				
Solid / stranded / conductor sizes	[mm <sup>2</sup> ]/[mm <sup>2</sup> ]/AWG	0.5 - 16 / 0.5 - 16 / 20 - 6		
Stranded with ferrule without / with plastic sleeve	[mm <sup>2</sup> ]	0.5 - 16 <sup>2)</sup> / 0.5 - 16 <sup>2)</sup>		
<b>Multiple connection (2 conductors with same cross section)</b>				
Solid / stranded	[mm <sup>2</sup> ]	0.5 - 6 / 0.5 - 6		
Stranded with ferrule without plastic sleeve	[mm <sup>2</sup> ]	0.5 - 4		
Stranded with TWIN ferrule with plastic sleeve	[mm <sup>2</sup> ]	0.5 - 6		
<b>Stripping length</b>	[mm]	14		
<b>Internal cylindrical gauge (IEC 60 947-1)</b>	—	A6		
<b>Thread</b>	—	M 4		
<b>Torque</b>	[Nm]	1.5 - 1.7		
<b>Insulating material</b>		PA		
Inflammability class in acc. with UL 94		V0		
<b>Approval data (UL/CUL and CSA)</b>				
Nominal voltage / current / conductor sizes	UL/CUL: [V]/[A]/AWG CSA: [V]/[A]/AWG	600 / 55 / 20 - 8		

<sup>1)</sup> Observe derating curve  
<sup>2)</sup> Only in connection with CRIMPFOX 16 S



# POWER COMBICON plugs PC 16/...-STF-10,16 10.16 mm Pitch



Description	No. of pos.	Dim. a [mm]	Type	Order No.	Pcs./Pkt.
<b>POWER COMBICON plugs, 10.16 mm pitch, color: green, with screw flange</b>	2	10.16	<b>PC 16/2-STF-10,16</b>	<b>19 67 45 6</b>	50
	3	20.32	<b>PC 16/3-STF-10,16</b>	<b>19 67 46 9</b>	
	4	30.48	<b>PC 16/4-STF-10,16</b>	<b>19 67 47 2</b>	
	5	40.64	<b>PC 16/5-STF-10,16</b>	<b>19 67 48 5</b>	
	6	50.80	<b>PC 16/6-STF-10,16</b>	<b>19 67 49 8</b>	
	7	60.96	<b>PC 16/7-STF-10,16</b>	<b>19 67 50 8</b>	
	8	71.12	<b>PC 16/8-STF-10,16</b>	<b>19 67 51 1</b>	
	9	81.28	<b>PC 16/9-STF-10,16</b>	<b>19 67 52 4</b>	
	(1) <b>Coding profile</b> , is inserted into the slot on the plug and header, red insulating material			<b>CP-HCC 4</b>	
(2) <b>Screwdriver</b> , blade: 1.0 x 4.0 x 100 mm, length: 200 mm			<b>SZS 1,0 x 4,0</b>	<b>12 05 06 6</b>	10
(3) <b>Marker card</b> , with 10 pcs., 10-section marker strips, white self-adhesive, for 100 terminal blocks			<b>SK 10/5</b> (see COMBICON catalog)		
(4) <b>Crimping pliers</b> , for ferrules up to 16 mm <sup>2</sup>			<b>CRIMPFOX 16 S</b>	<b>12 07 98 3</b>	1

### Technical data

Dimensions		see description		
Pitch	[mm]	10.16		
Hole diameter	[mm]	—		
Pin dimensions	[mm]x[mm]	—		
<b>Technical data in acc. with IEC/ DIN VDE</b>				
Insulating material group	—	I		
Surge voltage category / contamination class	—/—	III / 3	III / 2	II / 2
Rated voltage	[V]	1000	1000	1000
Rated surge voltage	[kV]	8	8	6
Nominal current / cross section	[A]/[mm <sup>2</sup> ]	76 <sup>1)</sup> / 16		
Maximum load current / cross section	[A]/[mm <sup>2</sup> ]	76 <sup>1)</sup> / 16		
<b>Connection capacity</b>				
Solid / stranded / conductor sizes	[mm <sup>2</sup> ]/[mm <sup>2</sup> ]/AWG	0.5 - 16 / 0.5 - 16 / 20 - 6		
Stranded with ferrule without / with plastic sleeve	[mm <sup>2</sup> ]	0.5 - 16 <sup>2)</sup> / 0.5 - 16 <sup>2)</sup>		
<b>Multiple connection (2 conductors with same cross section)</b>				
Solid / stranded	[mm <sup>2</sup> ]	0.5 - 6 / 0.5 - 6		
Stranded with ferrule without plastic sleeve	[mm <sup>2</sup> ]	0.5 - 4		
Stranded with TWIN ferrule with plastic sleeve	[mm <sup>2</sup> ]	0.5 - 6		
<b>Stripping length</b>	[mm]	14		
<b>Internal cylindrical gauge (IEC 60 947-1)</b>	—	A6		
<b>Thread</b>	—	M 4		
<b>Torque</b>	[Nm]	1.5 - 1.7		
<b>Insulating material</b>				
Inflammability class in acc. with UL 94		PA		
		V0		
<b>Approval data (UL/CUL and CSA)</b>				
Nominal voltage / current / conductor sizes	UL/CUL: [V]/[A]/AWG CSA: [V]/[A]/AWG	600 / 55 / 20 - 8		

<sup>1)</sup> Observe derating curve

<sup>2)</sup> Only in connection with CRIMPFOX 16 S

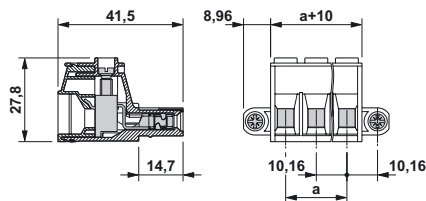

## POWER COMBICON plugs with screw flange and shield, 10.16 mm pitch

---

### PC 16/...-STF-SH-10,16

The PC 16 plug with shield provides a professional connection of the braided shield with currents of up to 76 A and connection cross sections of up to 16 mm<sup>2</sup> to prevent electrical interference. The largest possible contact of the shielded cable is decisive for compliance with EMC requirements and for high-quality shielding. To ensure optimum connection of the conductor with the shield, conventional metal cable clamps should be used (see photo). The shielded cable may also be connected to the engaged shield with a plastic cable tie. The screw integrated in the plug flange guarantees a perfect connection between the shroud and the metal front.

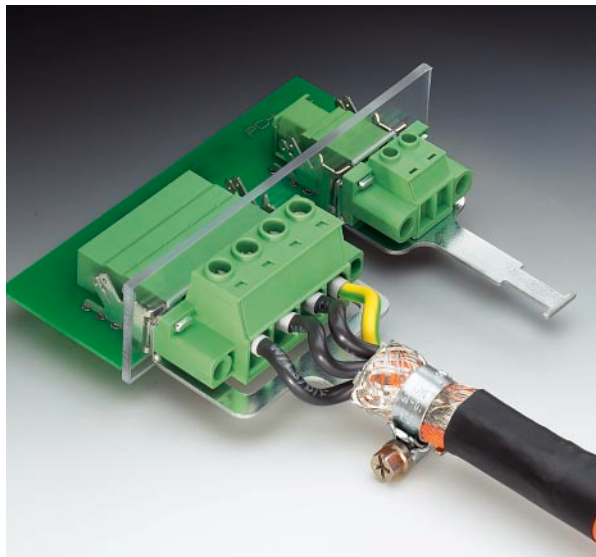

### POWER COMBICON PCB-SHIELD

If the housing wall or front panel is not conductive, it is possible to route the shielding function on to POWER COMBICON PCB-SHIELD directly on the PCB via the flange screw (see photo). The 6.3/2.8 x 0.8 mm slip-on connection can then also be used to reach the next grounding point along the shortest possible route.



**POWER COMBICON plugs**  
**PC 16/...-STF-SH-10,16**  
**10.16 mm Pitch**



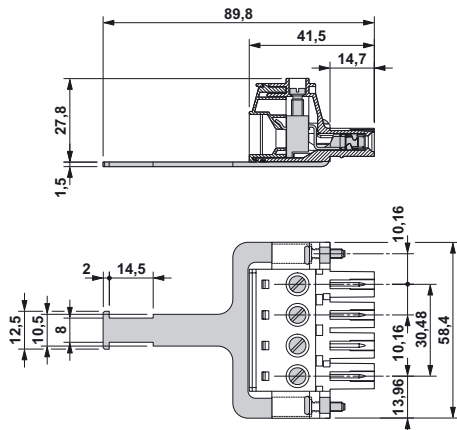

Description	No. of pos.	Dim. a [mm]	Type	Order No.	Pcs./Pkt.
<b>POWER COMBICON plugs, 10.16 mm pitch, color: green, with screw flange and shield</b>	4	30.48	<b>PC 16/4-STF-SH-10,16</b>	<b>19 70 35 9</b>	50
(1) <b>Coding profile</b> , is inserted into the slot on the plug and header, red insulating material			<b>CP-HCC 4</b>	<b>16 00 02 7</b>	50
(2) <b>Screwdriver</b> , blade: 1.0 x 4.0 x 100 mm, length: 200 mm			<b>SZS 1,0 x 4,0</b>	<b>12 05 06 6</b>	10
(3) <b>Marker card</b> , with 10 pcs., 10-section marker strips, white self-adhesive, for 100 terminal blocks			<b>SK 10/5</b> (see COMBICON catalog)		
(4) <b>Crimping pliers</b> , for ferrules up to 16 mm <sup>2</sup>			<b>CRIMPFOX 16 S</b>	<b>12 07 98 3</b>	1
<b>Technical data</b>					
Dimensions					
Pitch		[mm]	see description		
Hole diameter		[mm]	10.16		
Pin dimensions		[mm]x[mm]	—		
<b>Technical data in acc. with IEC/ DIN VDE</b>					
Insulating material group		—		I	
Surge voltage category / contamination class		—/—	III / 3	III / 2	II / 2
Rated voltage		[V]	1000	1000	1000
Rated surge voltage		[kV]	8	8	6
Nominal current / cross section		[A]/[mm <sup>2</sup> ]		76 <sup>1)</sup> / 16	
Maximum load current / cross section		[A]/[mm <sup>2</sup> ]		76 <sup>1)</sup> / 16	
<b>Connection capacity</b>					
Solid / stranded / conductor sizes		[mm <sup>2</sup> ]/[mm <sup>2</sup> ]/AWG	0.5 - 16 / 0.5 - 16 / 20 - 6		
Stranded with ferrule without / with plastic sleeve		[mm <sup>2</sup> ]	0.5 - 16 <sup>2)</sup> / 0.5 - 16 <sup>2)</sup>		
<b>Multiple connection (2 conductors with same cross section)</b>					
Solid / stranded		[mm <sup>2</sup> ]	0.5 - 6 / 0.5 - 6		
Stranded with ferrule without plastic sleeve		[mm <sup>2</sup> ]	0.5 - 4		
Stranded with TWIN ferrule with plastic sleeve		[mm <sup>2</sup> ]	0.5 - 6		
<b>Stripping length</b>		[mm]	14		
<b>Internal cylindrical gauge (IEC 60 947-1)</b>		—	A6		
<b>Thread</b>		—	M 4		
<b>Torque</b>		[Nm]	1.5 - 1.7		
<b>Insulating material</b>					
Inflammability class in acc. with UL 94		—	PA		
		—	V0		
<b>Approval data (UL/CUL and CSA)</b>					
Nominal voltage / current / conductor sizes		UL/CUL: [V]/[A]/AWG CSA: [V]/[A]/AWG	600 / 55 / 20 - 8		

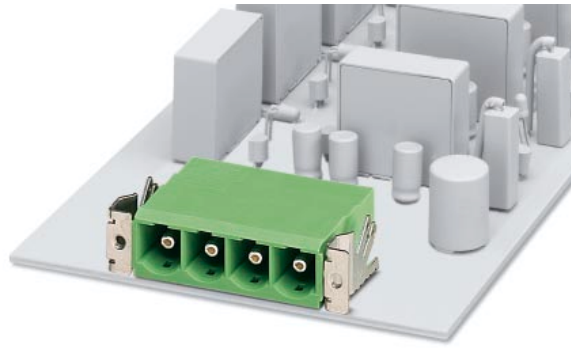

<sup>1)</sup> Observe derating curve  
<sup>2)</sup> Only in connection with CRIMPFOX 16 S

**POWER COMBICON headers with  
POWER COMBICON PCB-Shield  
PC 6-16/...-G-10,16  
10.16 mm Pitch**



Description	No. of pos.	Dim. a [mm]
<b>POWER COMBICON headers, 10.16 mm pitch, color: green</b>	3	20.32
	4	30.48
(1) <b>Coding profile</b> , is inserted into the slot on the plug and header, red insulating material		
(2) <b>Shroud</b> , connects the shield from the flange screw of the plug to the PCB with a 6.3/2.8 x 0.8 mm slip-on connection		
(3) <b>Marker card</b> , with 10 pcs., 10-section marker strips, white self-adhesive, for 100 terminal blocks		
<b>Technical data</b>		
Dimensions		
Pitch		[mm]
Hole diameter		[mm]
Pin dimensions		[mm]x[mm]
<b>Technical data in acc. with IEC/ DIN VDE</b>		
Insulating material group		—
Surge voltage category / contamination class		—/—
Rated voltage		[V]
Rated surge voltage		[kV]
Nominal current / cross section		[A]/[mm <sup>2</sup> ]
Maximum load current / cross section		[A]/[mm <sup>2</sup> ]
<b>Insulating material</b>		
Inflammability class in acc. with UL 94		
<b>Approval data (UL/CUL and CSA)</b>		
Nominal voltage / current / conductor sizes	UL/CUL: [V]/[A]/AWG	
	CSA: [V]/[A]/AWG	

Type	Order No.	Pcs./Pkt.
<b>PC 6-16/3-G-10,16</b>	<b>19 13 65 9</b>	50
<b>PC 6-16/4-G-10,16</b>	<b>19 13 66 2</b>	50
<b>CP-HCC 4</b>	<b>16 00 02 7</b>	50
<b>POWER COMBICON PCB-SHIELD</b>	<b>19 68 38 7</b>	50
<b>SK 10/5</b> (see COMBICON catalog)		
see description		
	10.16	
	1.7	
	1.0 x 1.2	
	I	
III / 3	III / 2	II / 2
630	1000	1000
6	8	6
	41 <sup>1)</sup> / --	
	41 <sup>1)</sup> / --	
	PA	
	V0	
	—	
	—	

<sup>1)</sup> With PC 6/... plug, 76 A with PC 16/.... plug

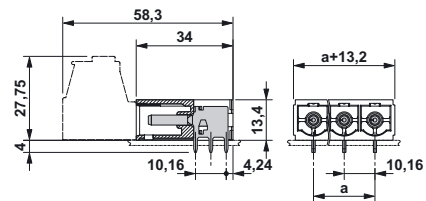
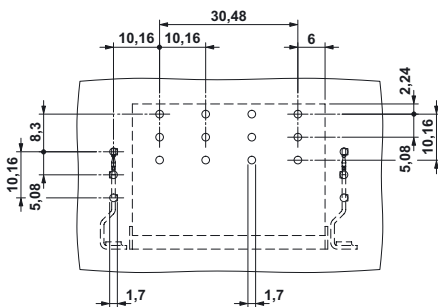

Additional technical data

---

<b>Contact resistance</b> (DIN EN 60 947-7-1/2)	< 5 mΩ
<b>Immunity to vibration</b> ((DIN EN 60 068-2-6:1996-05)	
- Frequency	10-150 Hz
- Amplitude	0.35 mm (10-60 Hz)
- Acceleration	50 m/s <sup>2</sup>
- Duration per axis	2.5 h
<b>Resistance to industrial atmospheres</b> (DIN 50 018:1997-06)	
- Level	KFW 0.2 S
- No. of cycles	2
<b>Insertion/withdrawal cycles</b>	≥ 100
Connection and disconnection forces	
- Connection	5 N per position
- Disconnection	4 N per position
- Note	per locking latch an additional power of 10 N should be considered

---