

HB-2X2-RS

~10° spot beam

TECHNICAL SPECIFICATIONS:

Dimensions	50.0 mm
Height	10 mm
Fastening	screw
Colour	clear
Box size	480 x 280 x 300 mm
Box weight	10.2 kg
Quantity in Box	800 pcs
ROHS compliant	yes ⓘ



MATERIAL SPECIFICATIONS:

Component	Type	Material	Colour
HB-2X2-RS	Lens array	PMMA	clear

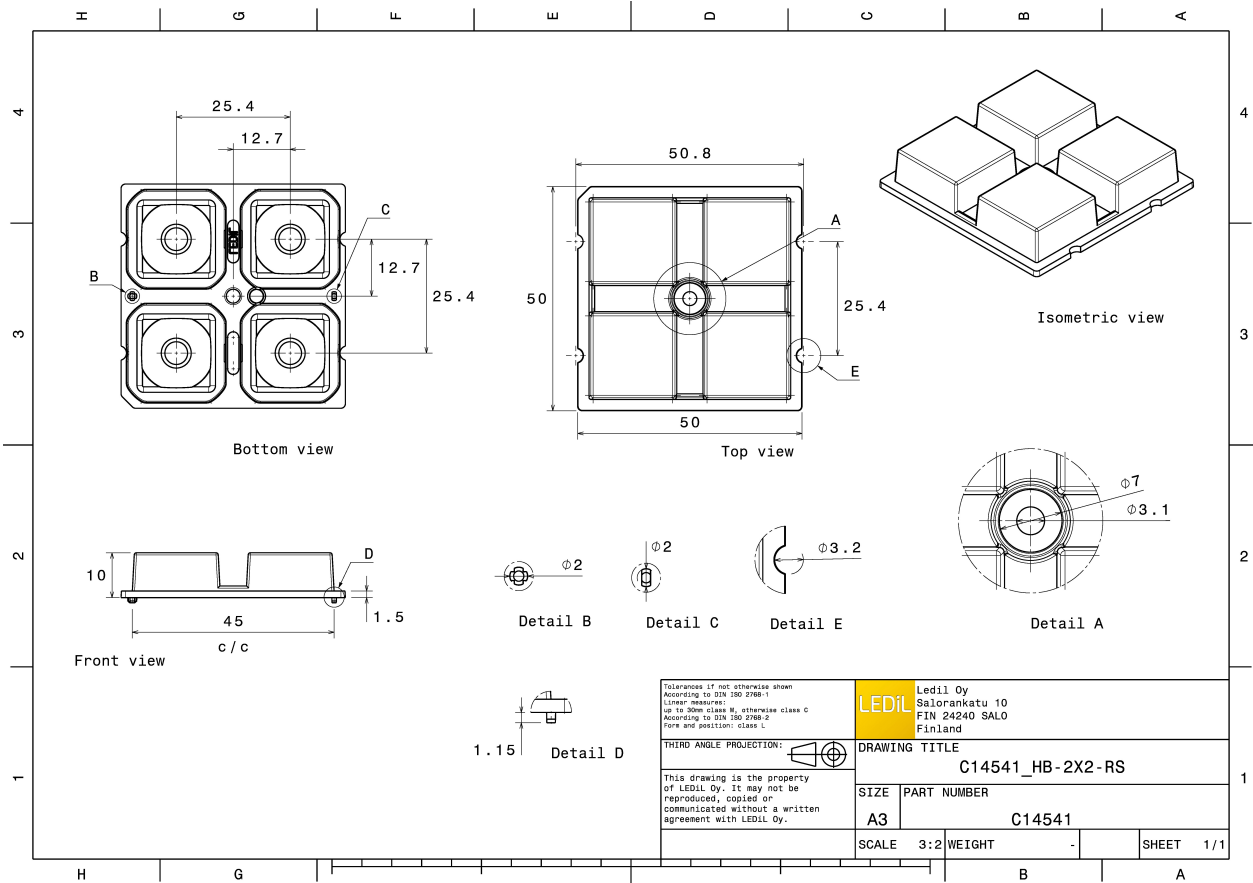

PHOTOMETRIC DATA (MEASURED):



LED XD16
 FWHM 11.0°
 Efficiency 93 %
 Peak intensity 13.500 cd/lm
 Required components:

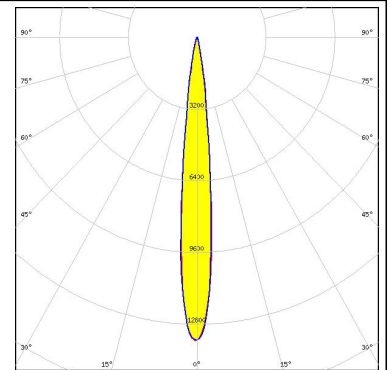

LED XHP35 HD
 FWHM 24.0°
 Efficiency 89 %
 Peak intensity 4.100 cd/lm
 Required components:

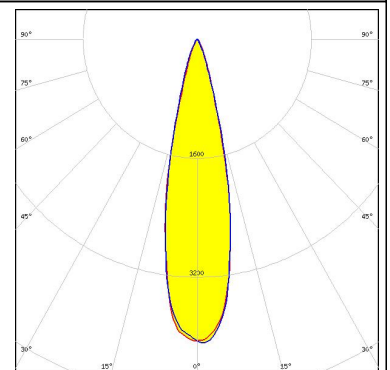
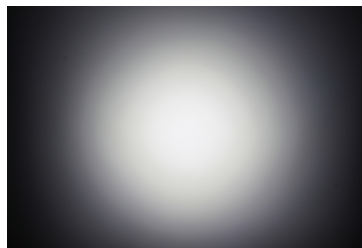



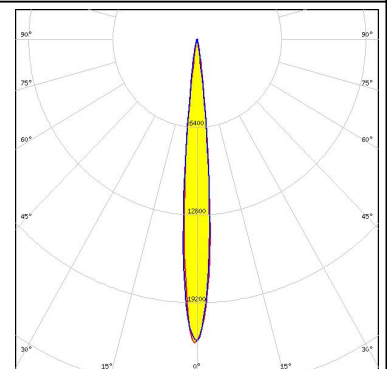
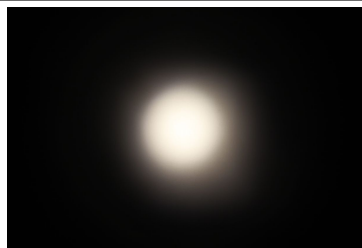

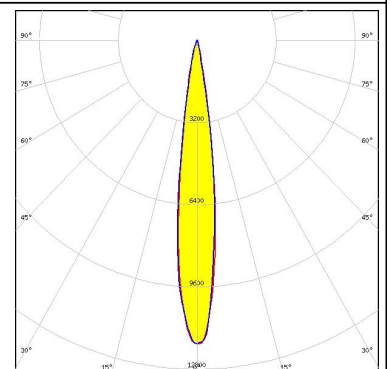

LED XP-E2
 FWHM 10.0°
 Efficiency 94 %
 Peak intensity 22.100 cd/lm
 Required components:

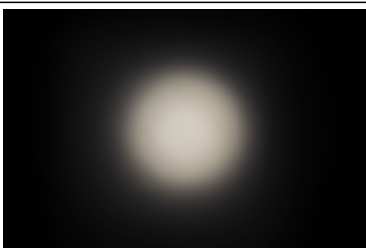
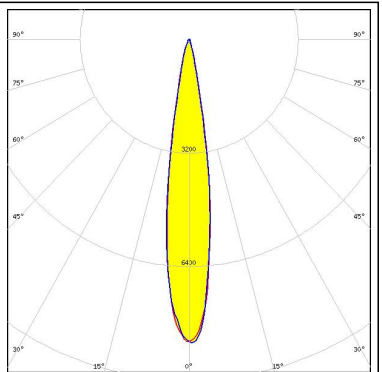

LED XP-G2
 FWHM 14.0°
 Efficiency 94 %
 Peak intensity 11.800 cd/lm
 Required components:

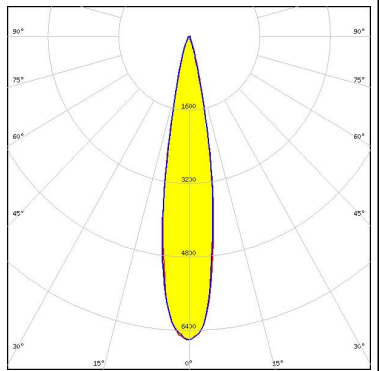

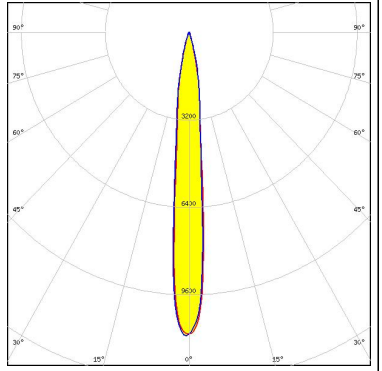
PHOTOMETRIC DATA (MEASURED):

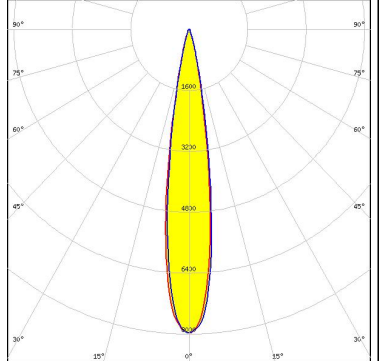
<p>NICHIA</p> <p>LED NVSW219D FWHM 17.0° Efficiency 94 % Peak intensity 8.600 cd/lm Required components:</p>		
<p>NICHIA</p> <p>LED NVSW3x9A FWHM 19.0° Efficiency 94 % Peak intensity 6.600 cd/lm Required components:</p>		
<p>NICHIA</p> <p>LED NVSxE21A FWHM 11.0° Efficiency 89 % Peak intensity 11.100 cd/lm Required components:</p>		
<p>NICHIA</p> <p>LED NVSxx19B/NVSxx19C FWHM 17.0° Efficiency 93 % Peak intensity 8.000 cd/lm Required components:</p>		

PHOTOMETRIC DATA (MEASURED):



LED NWSx229A
 FWHM 23.0°
 Efficiency 94 %
 Peak intensity 4.500 cd/lm
 Required components:

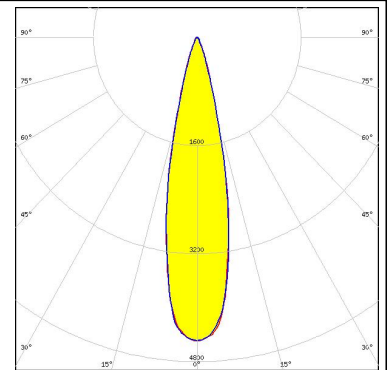

LED Oslon Square Gen3
 FWHM 15.0°
 Efficiency 90 %
 Peak intensity 11.000 cd/lm
 Required components:

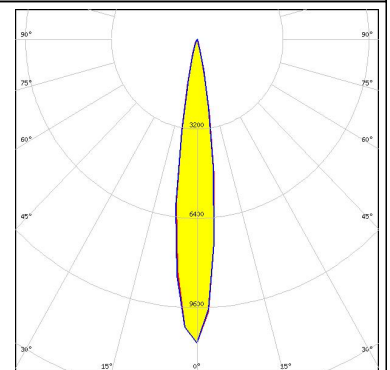

LED Fortimo FastFlex LED board 2x8 DA G4
 FWHM 13.0°
 Efficiency 93 %
 Peak intensity 12.500 cd/lm
 Required components:

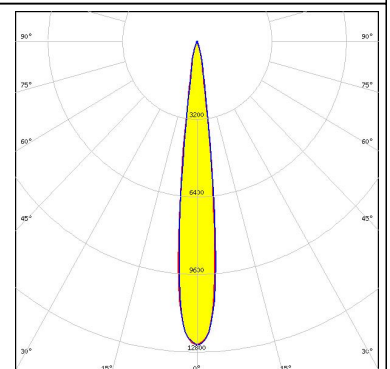
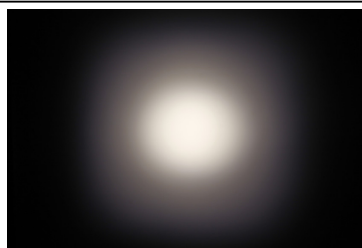

LED LH351B
 FWHM 17.0°
 Efficiency 89 %
 Peak intensity 8.040 cd/lm
 Required components:

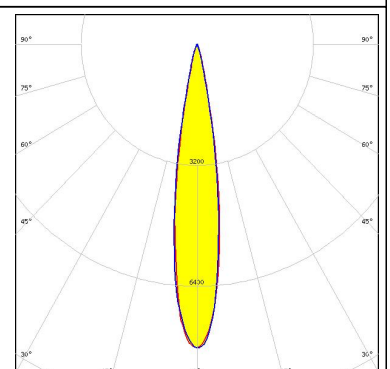

PHOTOMETRIC DATA (MEASURED):

SAMSUNG

LED LH351C
 FWHM 18.0°
 Efficiency 94 %
 Peak intensity 7.900 cd/lm
 Required components:

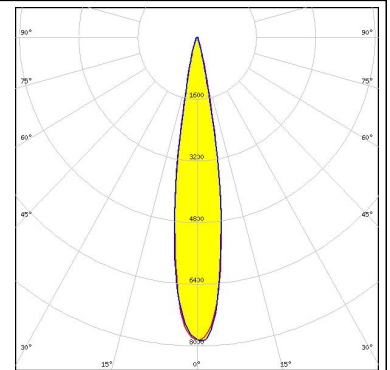

SAMSUNG

LED LH351D
 FWHM 22.0°
 Efficiency 94 %
 Peak intensity 4.900 cd/lm
 Required components:

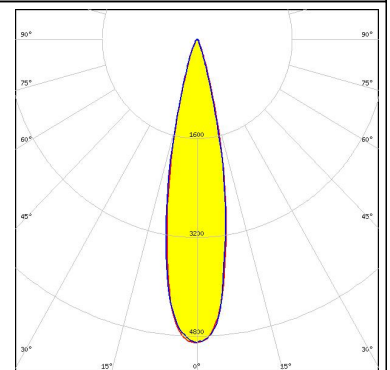
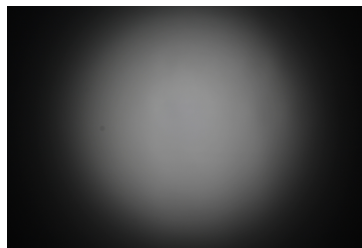

SEOUL SEMICONDUCTOR

LED Z8Y22
 FWHM 14.0°
 Efficiency 94 %
 Peak intensity 6.600 cd/lm
 Required components:

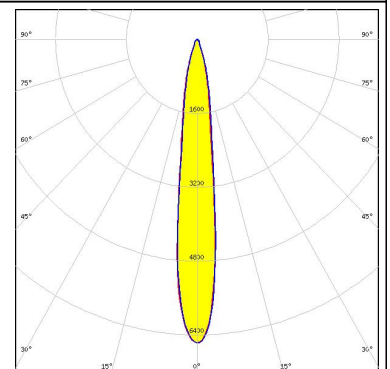
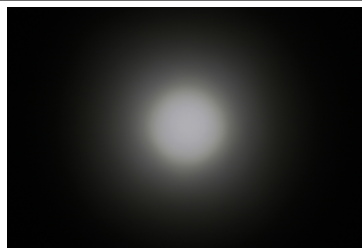

SEOUL SEMICONDUCTOR

LED Z8Y22P
 FWHM 16.0°
 Efficiency 93 %
 Peak intensity 6.900 cd/lm
 Required components:

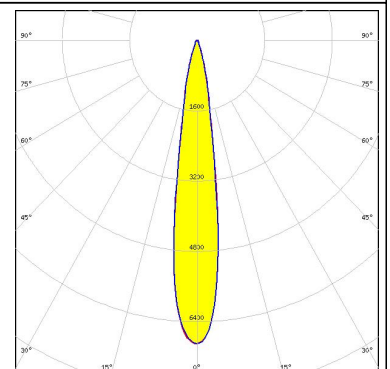
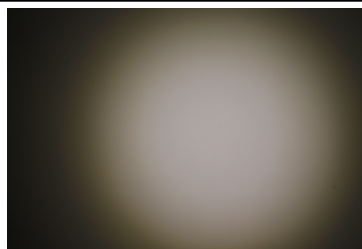

PHOTOMETRIC DATA (MEASURED):

TRIDONIC

LED RLE G1 49x121mm 2000lm xxx EXC OTD
FWHM 13.0°
Efficiency 94 %
Peak intensity 10.900 cd/lm
Required components:

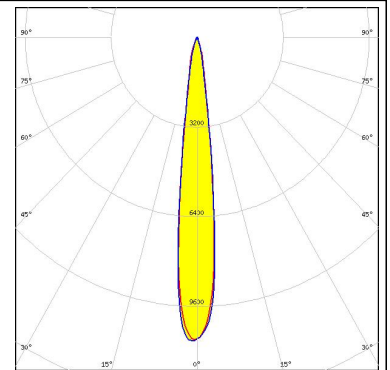

TRIDONIC

LED RLE G1 49x133mm 2000lm xxx EXC OTD
FWHM 13.0°
Efficiency 94 %
Peak intensity 10.900 cd/lm
Required components:

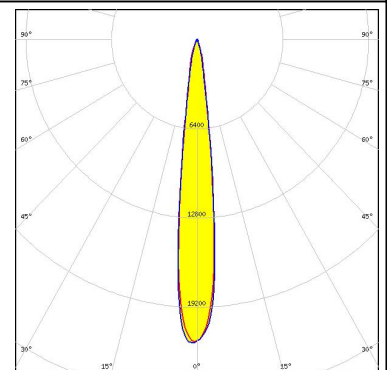

TRIDONIC

LED RLE G1 49x223mm 4000lm xxx EXC OTD
FWHM 13.0°
Efficiency 94 %
Peak intensity 10.900 cd/lm
Required components:

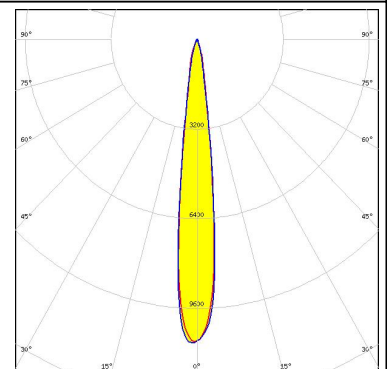
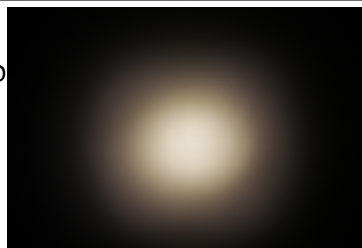

TRIDONIC

LED RLE G1 49x245mm 4000lm xxx EXC OTD
FWHM 13.0°
Efficiency 94 %
Peak intensity 10.900 cd/lm
Required components:

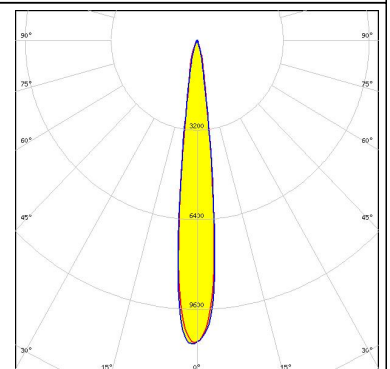

PHOTOMETRIC DATA (MEASURED):

TRIDONIC

LED RLE G2 HP 2x8 4000lm

FWHM 13.0°

Efficiency 94 %

Peak intensity 12.500 cd/lm

Required components:

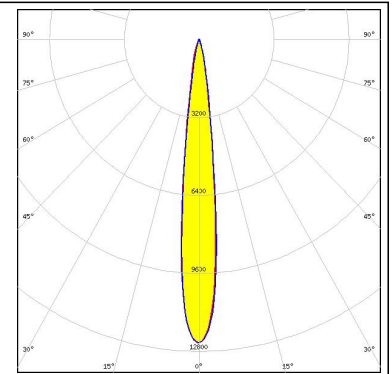
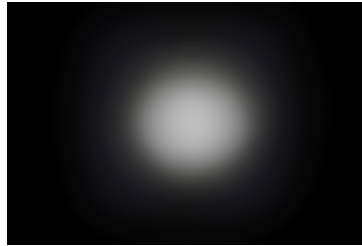

PHOTOMETRIC DATA (SIMULATED):



LED XHP35 HI
 FWHM 14.0°
 Efficiency 93 %
 Peak intensity 9.900 cd/lm
 Required components:

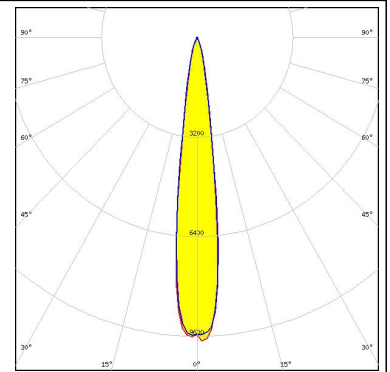

LED XM-L
 FWHM 19.0°
 Efficiency 92 %
 Peak intensity 5.620 cd/lm
 Required components:

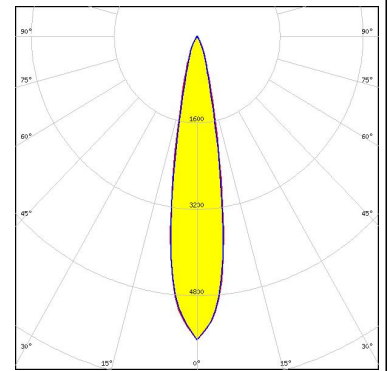

LED XM-L2
 FWHM 18.0°
 Efficiency 95 %
 Peak intensity 6.900 cd/lm
 Required components:

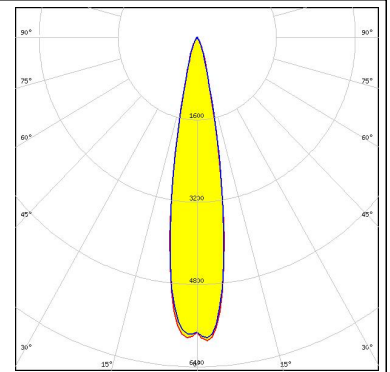

LED XP-G
 FWHM 13.0°
 Efficiency 93 %
 Peak intensity 12.100 cd/lm
 Required components:

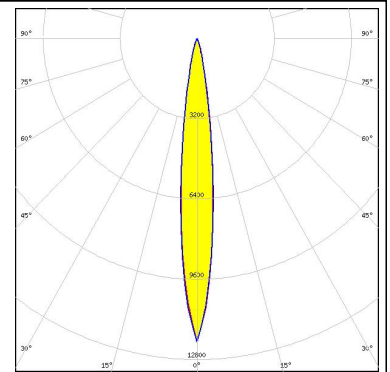

PHOTOMETRIC DATA (SIMULATED):



LED XP-L
 FWHM 19.0°
 Efficiency 94 %
 Peak intensity 6.140 cd/lm
 Required components:

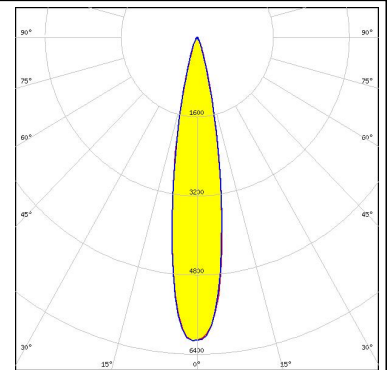

LED LUXEON C
 FWHM 11.0°
 Efficiency 94 %
 Peak intensity 16.200 cd/lm
 Required components:

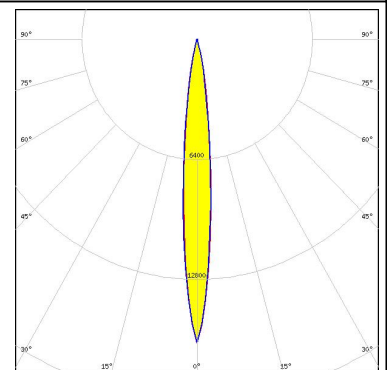

LED Oslon SSL 80
 FWHM 8.2°
 Efficiency 94 %
 Peak intensity 21.000 cd/lm
 Required components:

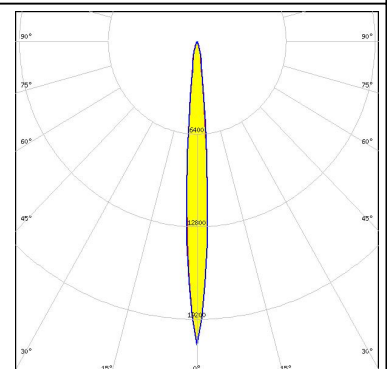

LED Z5M1/Z5M2
 FWHM 13.0°
 Efficiency 92 %
 Peak intensity 12.100 cd/lm
 Required components:

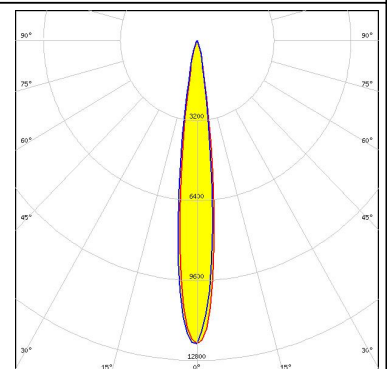

GENERAL INFORMATION:

NOTE: The typical beam angle will be changed by different color, chip size and chip position tolerance. The typical total beam angle is the full angle measured where the luminous intensity is half of the peak value.

MATERIALS:

As part of our continuous research and improvement processes, and to ensure the best possible quality and availability of our products, LEDiL reserves the right to change material grades without notice.

PRODUCT DATA USER AGREEMENT AND DISCLAIMER:

The measured data in the provided downloadable LEDiL Product Datasheets and Mechanical 2D-Drawings is rounded and provided as reference for planning. LEDiL Oy's optical specifications have been verified by conducting performance testing of the products in accordance with the company's quality system. The reported data are averaged results of multiple measurements with typical variation. LEDiL Oy reserves the right to without prior notification make changes and improvements to its products.

LEDiL Oy assumes neither warranty, nor guarantee nor any other liability of any kind for the contents and correctness of the provided data. The provided data has been generated with highest diligence but the provided data may in reality not represent the complete possible variation range of all intrinsic parameters. Therefore, in certain cases a deviation from the provided data could occur.

LEDiL Oy reserves the right to undertake technical changes of its products without further notification which could lead to changes in the provided data. LEDiL Oy assumes no liability of any kind for the possible deviation from any provided data or any other damage resulting from the usage of the provided data.

The user agrees to this disclaimer and user agreement with the download or usage of the provided files.

LEDiL Oy

Joensuunkatu 13
FI-24240 SALO
Finland

LEDiL Inc.

228 West Page Street
Suite D
Sycamore IL 60178
USA

Local sales and technical support

[www.ledil.com/
where_to_buy](http://www.ledil.com/where_to_buy)

Shipping locations

Salo, Finland
Hong Kong, China

Distribution Partners

[www.ledil.com/
where_to_buy](http://www.ledil.com/where_to_buy)