

AS1336

Dual, Low Voltage, Micropower DC-DC Step-Up Converters

1 General Description

The AS1336 is a dual synchronous, fixed frequency, very high-efficiency DC-DC boost converter capable of supplying guaranteed 75mA at 3.3V on each output from a 0.8V supply only. Compact size and minimum external parts requirements make this device perfect for modern portable devices.

High-speed switching frequency (1.2MHz) and internally compensated PWM current mode design provide highly-reliable DC-DC conversion, especially when driving white LEDs. MODE pins allow to enable automatic powersave mode for each regulator independently.

The AS1336 can supervise the battery voltage and generate a low battery error flag. A hysteresis ensures valid operation especially during start-up and end of life.

The device contains two internal MOSFET switches: one NMOS switch and one PMOS synchronous rectifier.

Anti-ringing control circuitry reduces EMI by damping the inductor in discontinuous mode, and the device exhibits extremely low current (< 2µA) in shutdown.

The AS1336A offers shutdown disconnect while in the AS1336B the battery is connected directly to the output during shutdown enabling the supply of real-time-clocks.

The AS1336 is available in a TQFN 3x3mm 16-pin package.

2 Key Features

- 96% Efficiency
- Operating Voltage from 0.8V to 3.6V
- Output Range: 1.8V to 3.6V
- Delivers 145mA @ 3.3V (from 1.5V)
- Low Start-Up Voltage: 0.8V
- High-Speed Fixed-Frequency: 1.2MHz
- Internal PMOS Synchronous Rectifier
- Automatic Powersave Operation
- Anti-Ringing Control Minimizes EMI
- Logic Controlled Shutdown (< 2µA)
- TQFN 3x3mm 16-pin Package

3 Applications

The AS1336 is ideal for low-power applications where ultra-small size is critical as in medical diagnostic equipment, mice, pagers, digital cameras, remote wireless transmitters, MP3 players, LCD bias supplies, cordless phones, GPS receivers, and PC cards.

Figure 1. Typical Application Diagram – Single Cell to 1.8V & 3.3V Synchronous Boost Converter

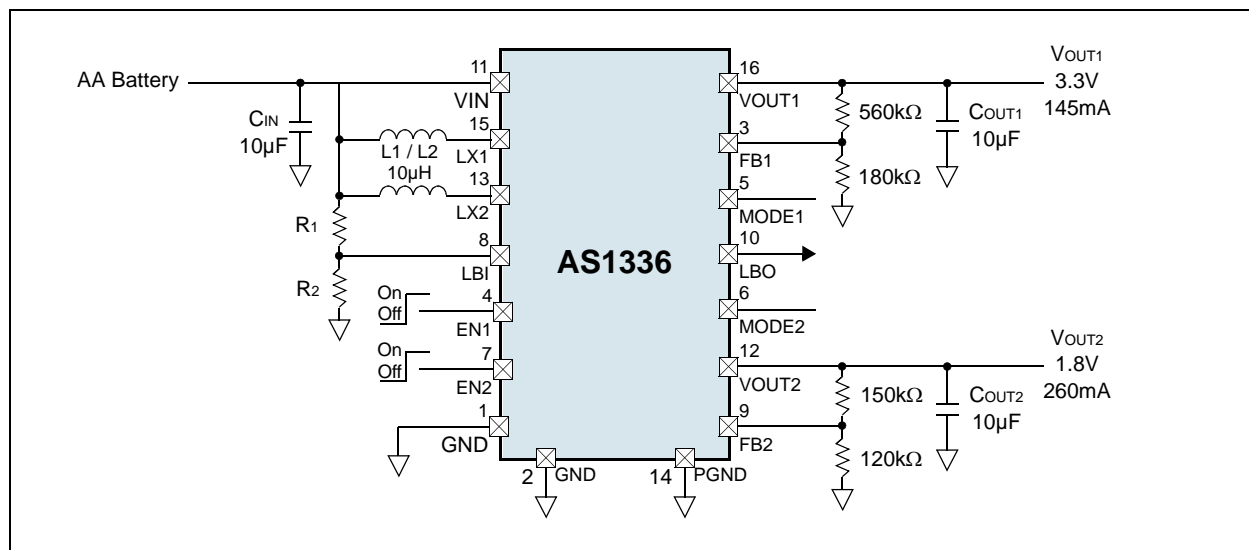

4 Pin Assignments

Figure 2. Pin Assignments (Top View)

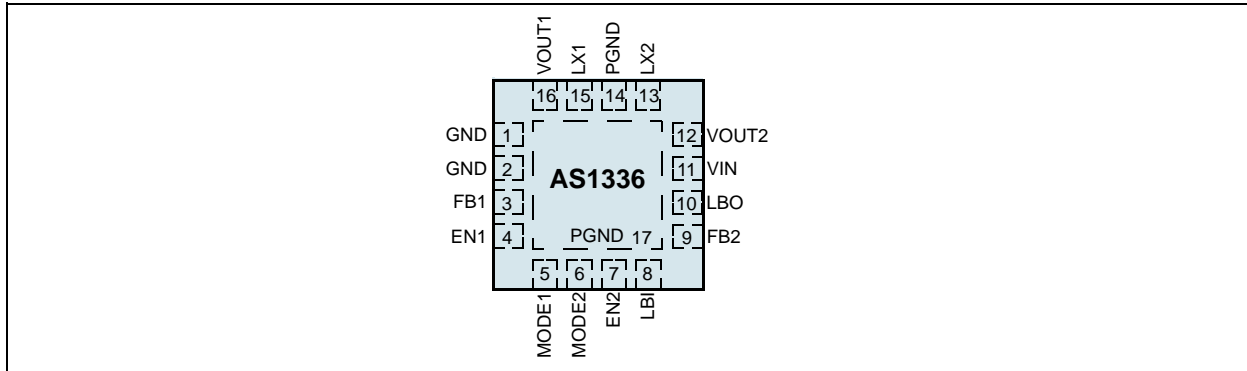

Pin Descriptions

Table 1. Pin Descriptions

Pin Name	Pin Number	Description
GND	1, 2	Signal Ground. These pins are used as a ground reference.
FB1	3	Feedback Pin. Feedback input to the g_m error amplifier. Connect a resistor divider tap to this pin. The output voltage can be adjusted from 1.8V to 3.6V by: $V_{OUT} = 0.8V[1 + (R_1/R_2)]$
EN1	4	Enable Pin. Logic controlled shutdown input. 1 = Normal operation, 1.2MHz typical operating frequency. 0 = Shutdown; quiescent current $<2\mu A$. The EN1 pin is connected to GND via an internal pull-down resistor.
MODE1	5	Mode Pin. Logic-controlled mode input for automatic powersave operation of regulator 1. 1 = Fixed frequency operation. 0 = Automatic powersave operation;
MODE2	6	Mode Pin. Logic-controlled mode input for automatic powersave operation of regulator 2. 1 = Fixed frequency operation. 0 = Automatic powersave operation;
EN2	7	Enable Pin. Logic controlled shutdown input. 1 = Normal operation, 1.2MHz typical operating frequency. 0 = Shutdown; quiescent current $<2\mu A$. The EN2 pin is connected to GND via an internal pull-down resistor.
LBI	8	Low Battery Comperator Input. May not be left floating, should be connected to GND if it is not used. 0.6V Threshold.
FB2	9	Feedback Pin. Feedback input to the g_m error amplifier. Connect a resistor divider tap to this pin. The output voltage can be adjusted from 1.8V to 3.6V by: $V_{OUT} = 0.8V[1 + (R_1/R_2)]$
LBO	10	Low Battery Comperator Output. This output is low when the voltage on LBI is less than 0.6V. The logic level is not valid in shutdown and during startup.
VIN	11	Battery Voltage Input
VOUT2	12	Output Voltage Sense Input and Drain of the Internal PMOS Synchronous Rectifier. Bias is derived from Vout2 when Vout2 exceeds VIN. PCB trace length from Vout2 to the output filter capacitor(s) should be as short and wide as is practical.

Table 1. Pin Descriptions

Pin Name	Pin Number	Description
LX2	13	<p>Switch Pin 2. Connect an inductor between this pin and V_{IN}. Keep the PCB trace lengths as short and wide as is practical to reduce EMI and voltage overshoot. If the inductor current falls to zero, or pin EN is low, an internal 100Ω anti-ringing switch is connected from this pin to V_{IN} to minimize EMI.</p> <p>Note: An optional Schottky diode can be connected between this pin and V_{OUT2}.</p>
PGND	14	Power Ground
LX1	15	<p>Switch Pin 1. Connect an inductor between this pin and V_{IN}. Keep the PCB trace lengths as short and wide as is practical to reduce EMI and voltage overshoot. If the inductor current falls to zero, or pin EN is low, an internal 100Ω anti-ringing switch is connected from this pin to V_{IN} to minimize EMI.</p> <p>Note: An optional Schottky diode can be connected between this pin and V_{OUT1}.</p>
VOUT1	16	<p>Output Voltage Sense Input and Drain of the Internal PMOS Synchronous Rectifier. Bias is derived from V_{OUT1} when V_{OUT1} exceeds V_{IN}. PCB trace length from V_{OUT1} to the output filter capacitor(s) should be as short and wide as is practical.</p>
PGND	17	Exposed Pad Power Ground. The exposed pad serves as power ground for both boost converters. Must be soldered to the PCB ground plane.

5 Absolute Maximum Ratings

Stresses beyond those listed in [Table 2](#) may cause permanent damage to the device. These are stress ratings only, and functional operation of the device at these or any other conditions beyond those indicated in [Section 6 Electrical Characteristics on page 5](#) is not implied. Exposure to absolute maximum rating conditions for extended periods may affect device reliability.

Table 2. Absolute Maximum Ratings

Parameter	Min	Max	Units	Notes
All Pins to GND	-0.3	5	V	
Operating Temperature Range	-40	+85	°C	
Storage Temperature Range	-65	+125	°C	
Latch-Up	-100	100	mA	@85°C, JEDEC 78
ESD		1	kV	HBM MIL-Std. 883E 3015.7 methods
Package Body Temperature		+260	°C	The reflow peak soldering temperature (body temperature) specified is in accordance with IPC/JEDEC J-STD-020D "Moisture/Reflow Sensitivity Classification for Non-Hermetic Solid State Surface Mount Devices". The lead finish for Pb-free leaded packages is matte tin (100% Sn).

6 Electrical Characteristics

$V_{IN} = +1.2V$, $V_{OUT} = +3.0V$, $V_{EN} = +1.2V$, $T_{AMB} = -40^{\circ}C$ to $+85^{\circ}C$, T_{yp} values @ $T_{AMB} = +25^{\circ}C$ (unless otherwise specified).

Table 3. Electrical Characteristics

Symbol	Parameter	Conditions	Min	Typ	Max	Units
	Minimum Start-Up Voltage	$I_{LOAD} = 1mA$		0.8	1	V
V_{MIN}	Minimum Operating Voltage			0.65	0.8	V
	Operating Voltage		V_{MIN}		$V_{OUT1,2}$	V
	Output Voltage Adjust Range		1.8		3.6	V
	Output Voltage Accuracy		-3		+3	%
V_{FB}	Feedback Voltage		784	800	816	mV
I_{FB}	Feedback Input Current	$V_{FB} = 0.8V$		1		nA
V_{IL}	LBI voltage threshold	V_{LBI} voltage decreasing	588	600	612	mV
	LBI hysteresis			25		
	LBI input current	$EN = V_{IN}$ or GND		1	100	nA
I_Q	Quiescent Current (Active)	$V_{FB} = V_{OUT}^1$, two cores active		260		μA
I_{QPWS}	Quiescent Current (Powersave Operation)	$V_{FB} = V_{OUT}^1$, two cores active		20		μA
		$V_{FB} = V_{OUT}$, one core active		14		
I_{SHDN}	Shutdown Current (including leakage)	$V_{EN} = 0V$		0.02	5	μA
I_{NMOSWL}	NMOS Switch Leakage	$V_{SW} = 5V$		0.1	5	μA
I_{PMOSWL}	PMOS Switch Leakage	$V_{SW} = 0V$		0.1	5	μA
R_{ONNMOS}	NMOS Switch On Resistance			0.25		Ω
	PMOS Switch On Resistance			0.35		
I_{NMOS}	NMOS Current Limit	$V_{IN} = 2.5V$		500		mA
I_{PS}	Powersave Operation Current Threshold			9		mA
	Max Duty Cycle ²	$V_{FB} = 0.7V$, $T_{AMB} = T_{MIN}$ to T_{MAX}	80	87		%
f_{SW}	Switching Frequency		0.85	1.2	1.5	MHz
V_{ENH}	EN Input High		1			V
V_{ENL}	EN Input Low				0.25	V
I_{EN}	EN Input Current	$V_{IN} = 1.2V$		0.7	2	μA
	Efficiency $V_{IN} = 1.2V$, $V_{OUT} = 2.5V$	$I_{LOAD} = 100mA$		83		%
		$I_{LOAD} = 50mA$		90		
		$I_{LOAD} \geq 100\mu A$		50		
		$I_{LOAD} \geq 50\mu A$		43		
	Output Ripple $V_{IN} = 1.2V$, $V_{OUT} = 2.7V$	$I_{LOAD} = 5\mu A$ to $100mA$		50		mVpk-pk

1. I_{QPWS} is measured at V_{OUT} . Multiply this value by V_{OUT}/V_{IN} to get the equivalent input (battery) current.

2. Guaranteed by design and verified in lab characterisation.

Note: All limits are guaranteed. The parameters with min and max values are guaranteed with production tests or SQC (Statistical Quality Control) methods.

7 Typical Operating Characteristics

$V_{IN} = 1.2V$, $V_{OUT} = 3.0V$, $L1 = L2 = 10\mu H$, $C_{OUT1} = C_{OUT2} = 10\mu F$, $T_{AMB} = +25^{\circ}C$ (unless otherwise specified);

Figure 3. Efficiency vs. Input Voltage, $V_{OUT} = 1.8V$

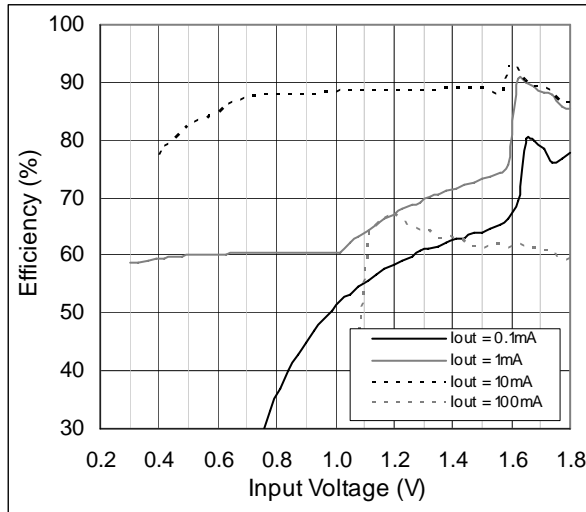

Figure 4. Efficiency vs. Input Voltage, $V_{OUT} = 2.5V$

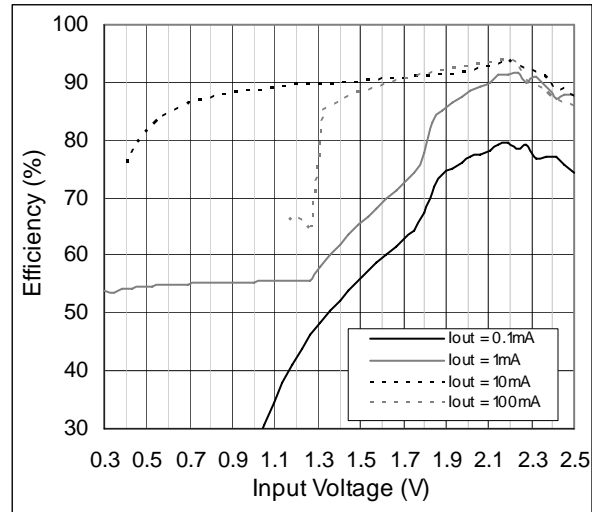

Figure 5. Efficiency vs. Input Voltage, $V_{OUT} = 3.0V$

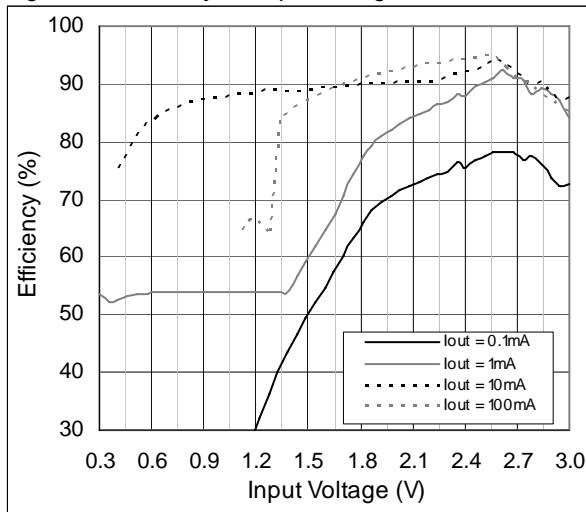

Figure 6. Efficiency vs. Input Voltage, $V_{OUT} = 3.3V$

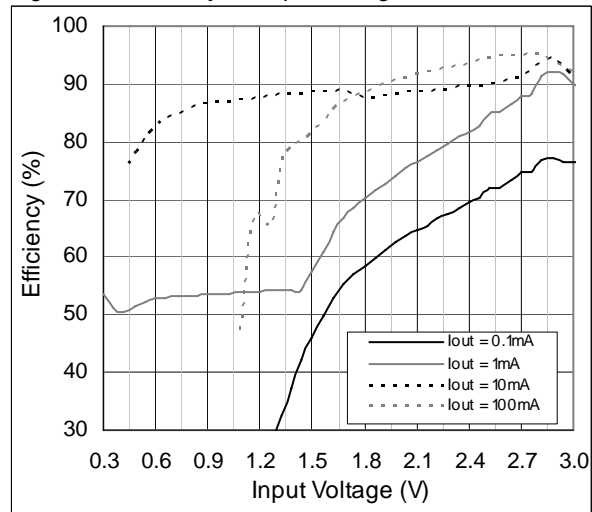

Figure 7. Efficiency vs. Output Current, $V_{OUT} = 1.8V$

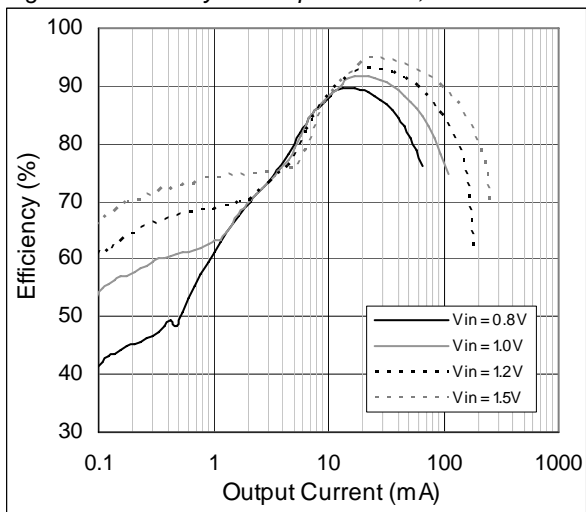

Figure 8. Efficiency vs. Output Current, $V_{OUT} = 2.5V$

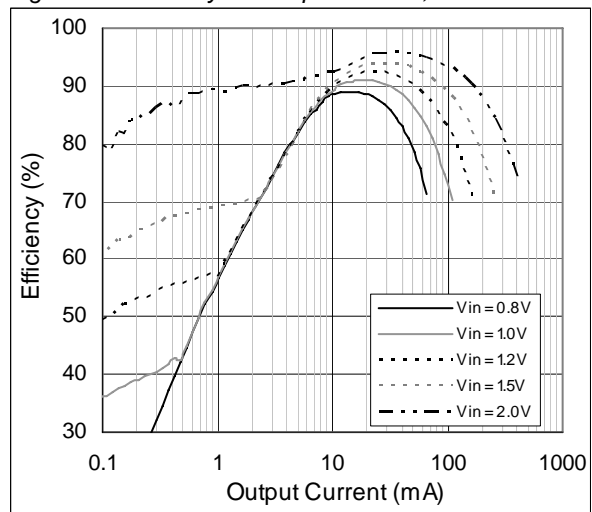

Figure 9. Efficiency vs. Output Current, $V_{OUT} = 3.0V$

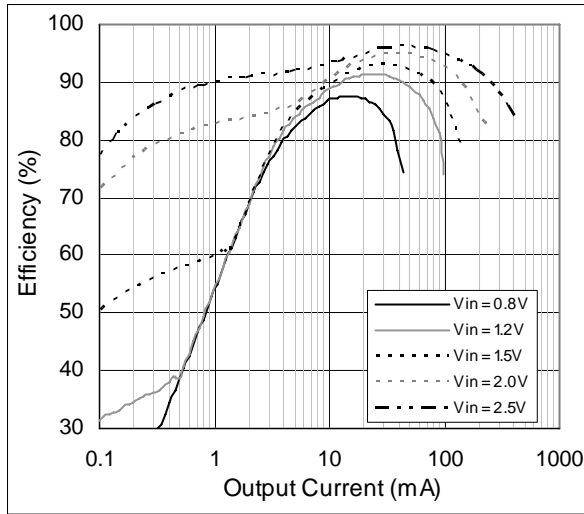

Figure 10. Efficiency vs. Output Current, $V_{OUT} = 3.3V$

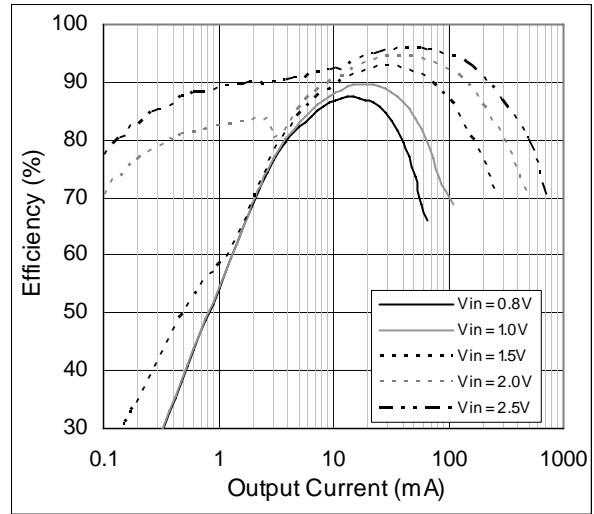

Figure 11. Efficiency vs. I_{OUT} - Mode, $V_{IN} = 0.8V$

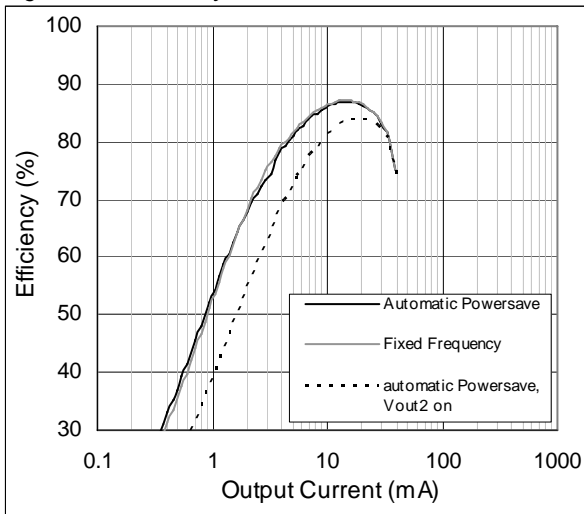

Figure 12. Efficiency vs. I_{OUT} - Mode, $V_{IN} = 1.5V$

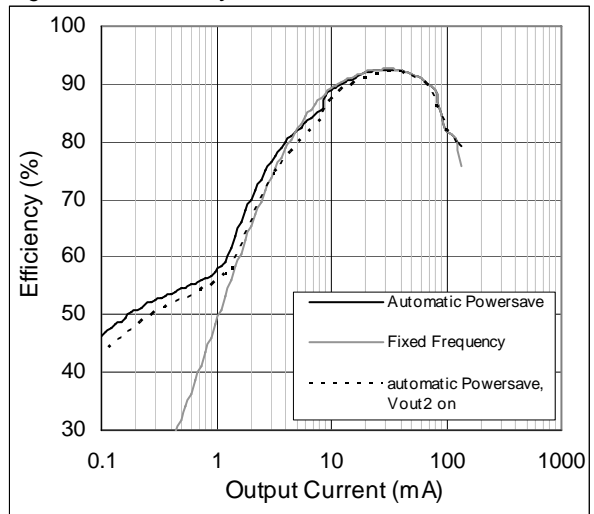

Figure 13. Efficiency vs. I_{OUT} - Mode, $V_{IN} = 2.5V$

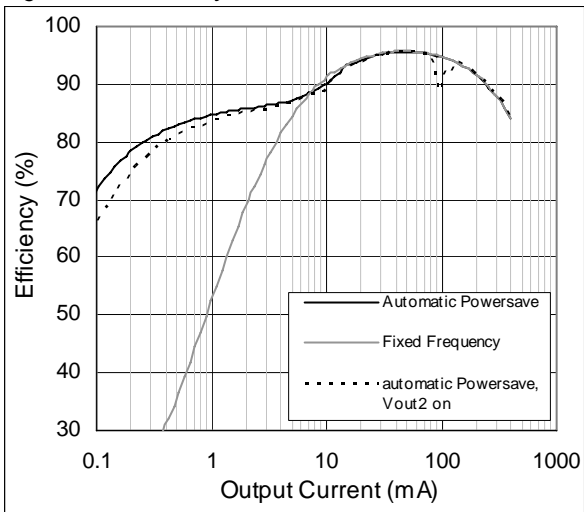

Figure 14. Efficiency vs. I_{OUT} - Mode, $V_{IN} = 3.0V$

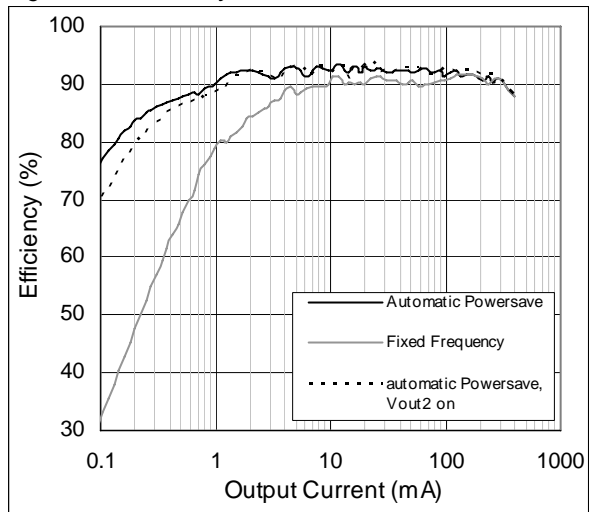

Figure 15. $I_{OUT\ max}$ vs. V_{IN} , $V_{OUT} = 1.8V$

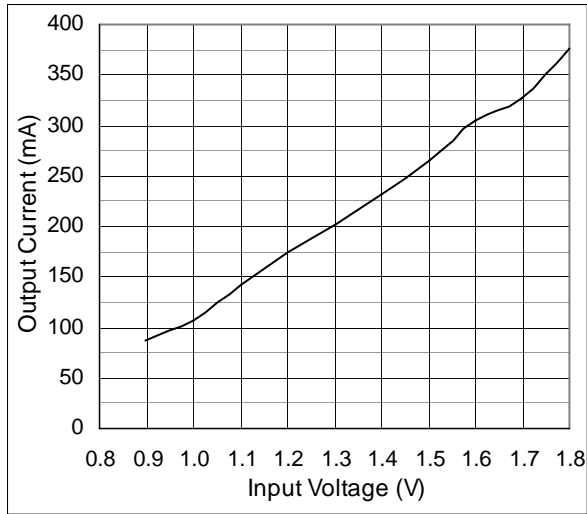

Figure 16. $I_{OUT\ max}$ vs. V_{IN} , $V_{OUT} = 3.3V$

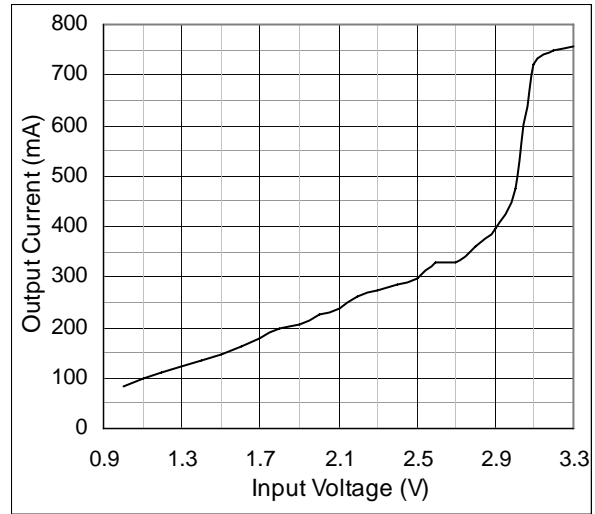

Figure 17. Startup Voltage vs. Output Current

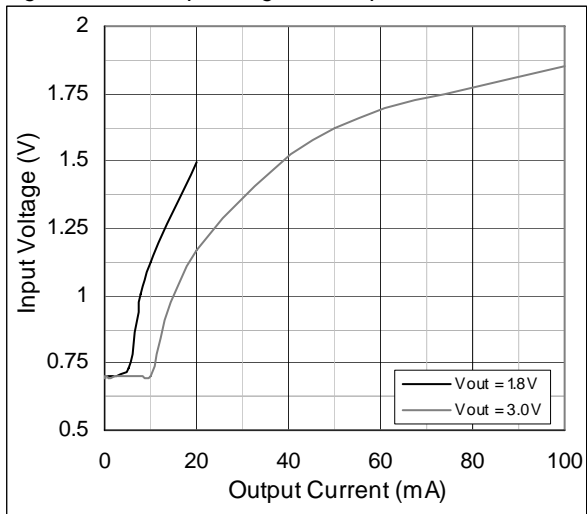

Figure 18. V_{OUT} vs. V_{IN} , $I_{OUT} = 10mA$

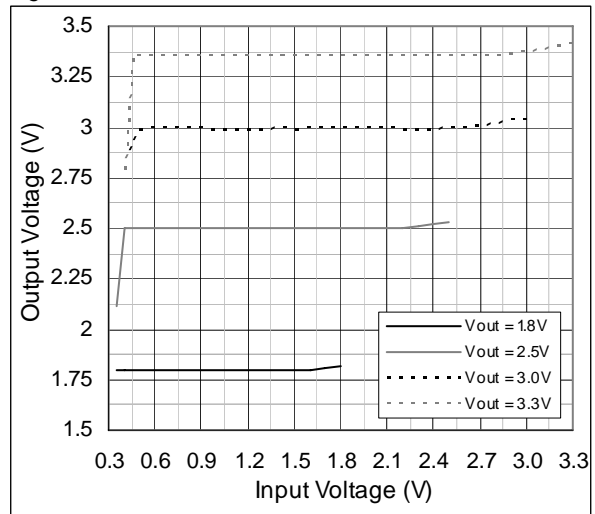

Figure 19. Input Current vs. Input Voltage

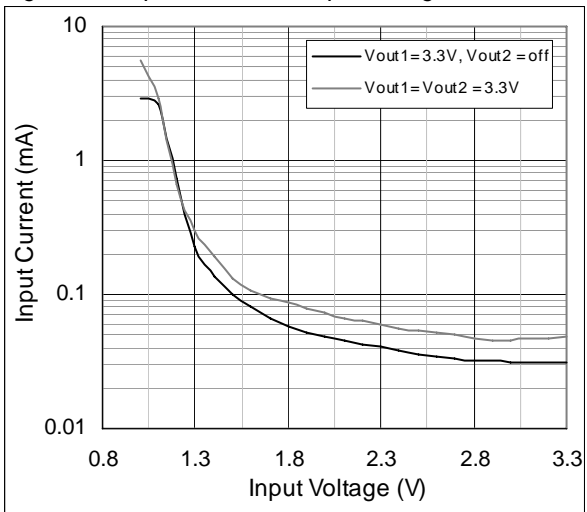

Figure 20. Powersave Threshold vs. Input Voltage

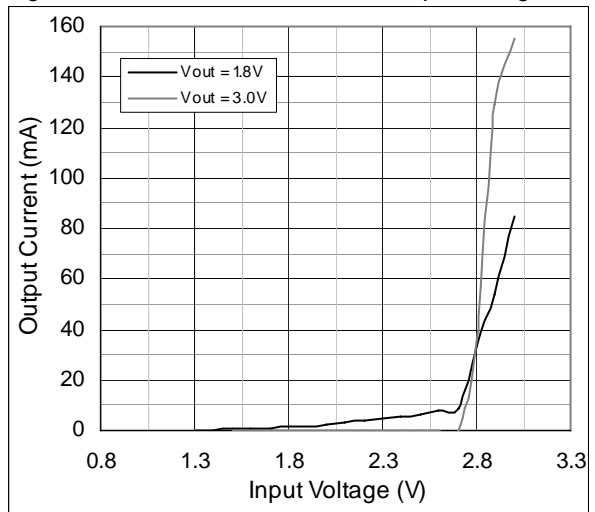

Figure 21. Startup Voltage, $I_{OUT} = 1mA$

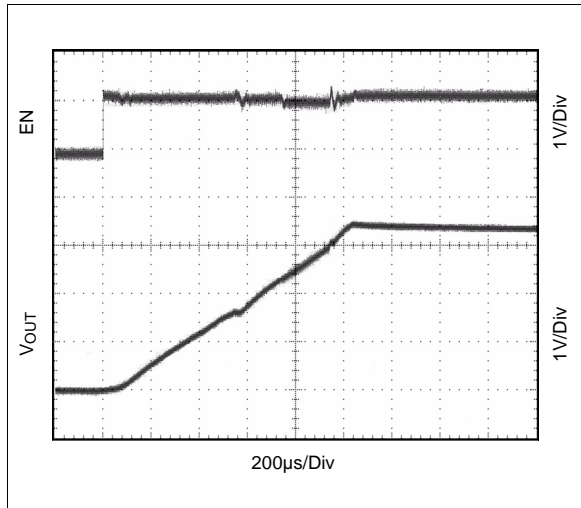

Figure 22. Shutdown Voltage, $I_{OUT} = 1mA$

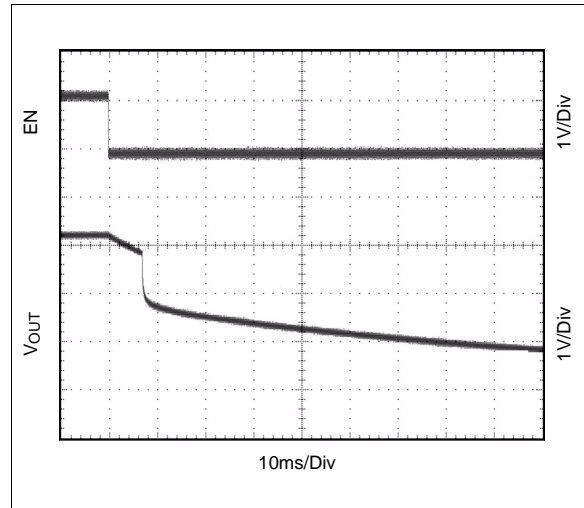

Figure 23. Coil Voltage, $I_{OUT} = 1mA$

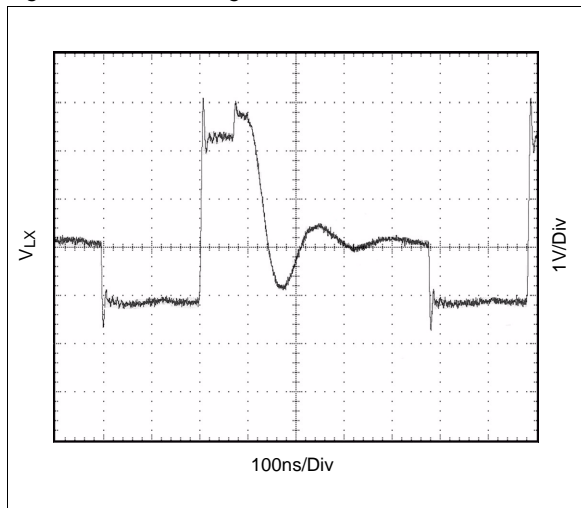

Figure 24. Coil Voltage, $I_{OUT} = 100mA$

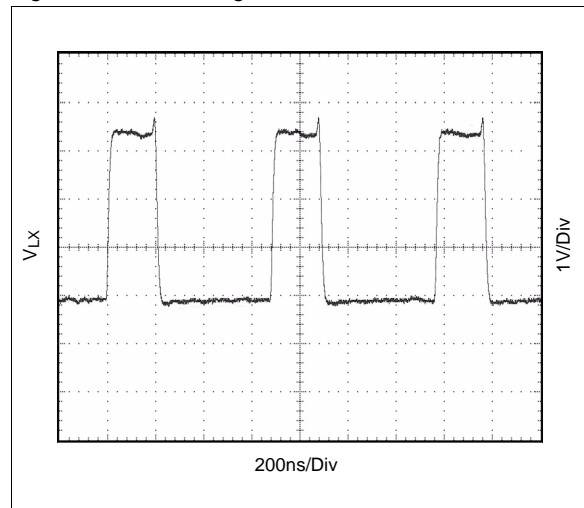
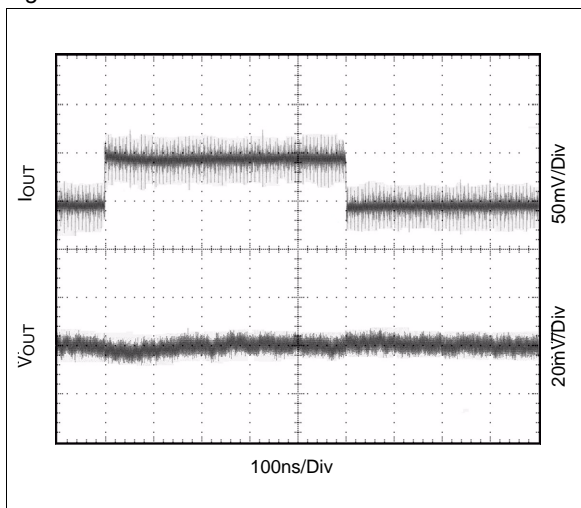

Figure 25. Load Transient



8 Detailed Description

The AS1336 is a dual synchronous boost converter and can operate from a single-cell input voltage (V_{IN}) below 0.8V, and features fixed frequency (1.2MHz) and current mode PWM control for exceptional line- and load-regulation. With low $R_{DS(ON)}$ and gate charge internal NMOS and PMOS switches, the device maintains high-efficiency from light to heavy loads.

Figure 26. AS1336 - Block Diagram

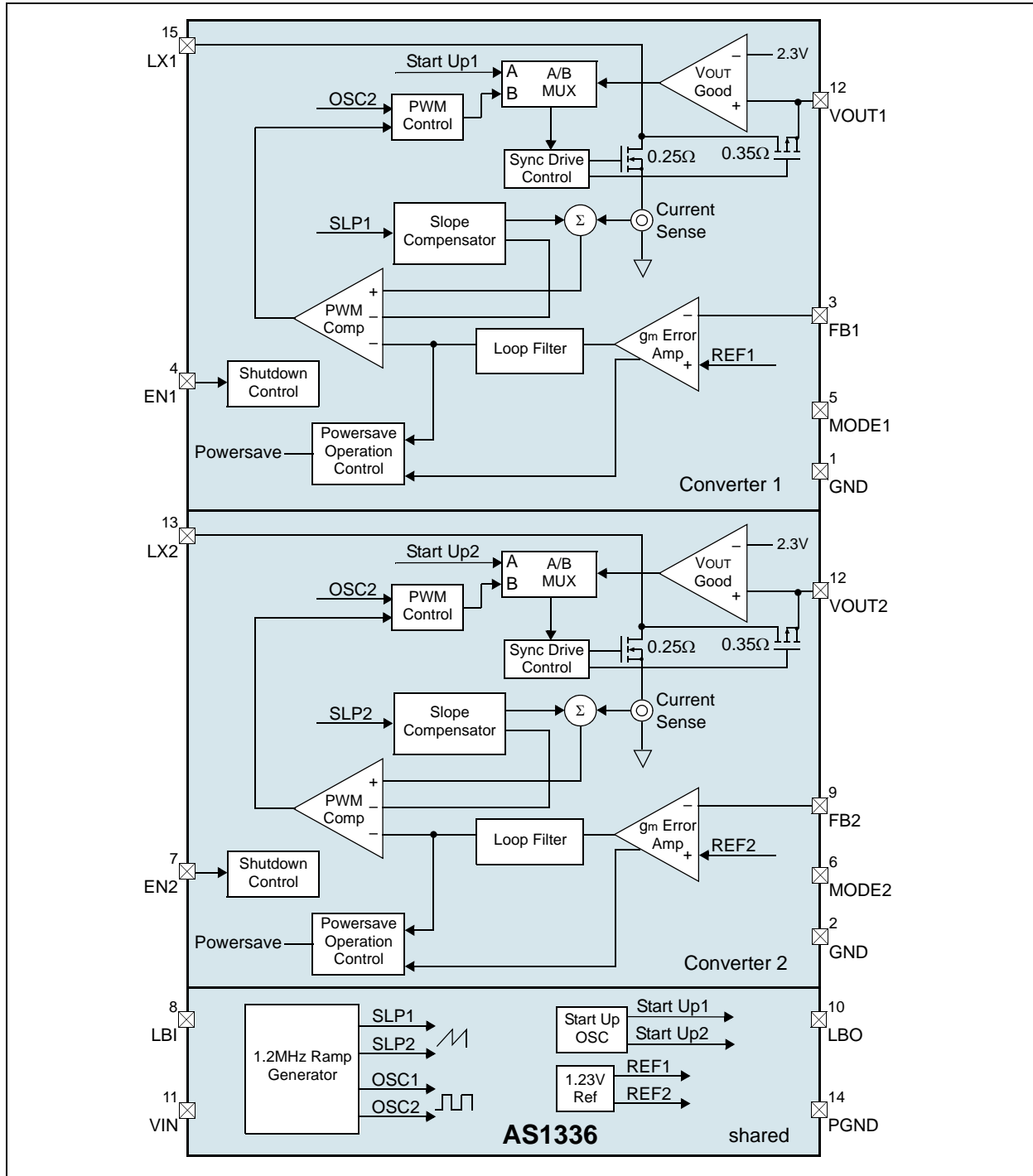

Modern portable devices frequently spend extended time in low-power or standby modes, switching to high power-drain only when certain functions are enabled. The AS1336 is ideal for portable devices since it maintain high-power conversion efficiency over a wide output power range, thus increasing battery life in these types of devices.

In addition to high-efficiency at moderate and heavy loads, the AS1336 includes an automatic powersave mode that improves efficiency of the power converter at light loads. The powersave mode is initiated if the output load current falls below a factory programmed threshold.

Low-Voltage Start-Up

The AS1336 requires V_{IN} of only 0.8V or higher to start up.

With a $V_{OUT} > 1.6V$, the start-up circuitry is disabled and normal fixed-frequency PWM operation is initiated. In this mode, the AS1336 operates independent of V_{IN} , allowing extended operating time as the battery can drop to several tenths of a volt without affecting output regulation. The limiting factor for the application is the ability of the battery to supply sufficient energy to the output.

Low-Noise Fixed-Frequency Operation

Oscillator

The AS1336 switching frequency is internally fixed at 1.2MHz allowing the use of very small external components.

Error Amplifier

The integrated error amplifier is an internally compensated trans-conductance (g_m) type (current output). The internal 0.8V reference voltage is compared to the voltage at pin FB to generate an error signal at the output of the error amplifier. For the adjustable output voltage version, a voltage divider from V_{OUT} to GND programs the output voltage from 1.8 to 3.6V via pin FB as:

$$V_{OUT} = 0.8V(1 + (R1/R2)) \quad (EQ 1)$$

Current Sensing

A signal representing the internal NMOS-switch current is summed with the slope compensator. The summed signal is compared to the error amplifier output to provide a peak current control command for the PWM. Peak switch current is limited to approximately 500mA independent of V_{IN} or V_{OUT} .

Zero Current Comparator

The zero current comparator monitors the inductor current to the output and shuts off the PMOS synchronous rectifier once this current drops to 20mA (approx.). This prevents the inductor current from reversing polarity and results in improved converter efficiency at light loads.

Anti-Ringing Control

Anti-ringing control circuitry prevents high-frequency ringing on pin SW as the inductor current approaches zero. This is accomplished by damping the resonant circuit formed by the inductor and the capacitance on pin SW (C_{sw}).

Powersave Operation

Powersave operation is enabled for one boost converter if the correspondent MODE pin is set to GND. This setting applies to both boost converters integrated on the chip. Each boost converter will then switch into powersave mode independently on the other if a low output current is below the powersave operation current threshold.

In light load conditions, the integrated powersave feature removes power from all circuitry not required to monitor V_{OUT} . When V_{OUT} has dropped approximately 1% from nominal, the AS1336 powers up and begins normal PWM operation.

C_{OUT} (see Figure 26 on page 10) recharges, causing the AS1336 to re-enter powersave mode as long as the output load remains below the powersave threshold. The frequency of this intermittent PWM is proportional to load current; i.e., as the load current drops further below the powersave threshold, the AS1336 turns on less frequently. When the load current increases above the powersave threshold, the AS1336 will resume continuous, seamless PWM operation.

Notes:

1. An optional capacitor (CFF) between pins VOUT and FB in some applications can reduce VOUT_{p-p} ripple and input quiescent current during powersave mode. Typical values for CFF range from 15 to 220pF.
2. In powersave mode the AS1336 draws only 14µA (one channel on) from the output capacitor(s), greatly improving converter efficiency.

Shutdown

Both boost converters can be enabled independently from the other. EN1 will enable boost converter 1 and EN2 enables boost converter 2.

When pin EN1 or EN2 is low the AS1336 the corresponding boost converter is switched off and <1µA current is drawn from battery; when pin EN1 or EN2 is high the corresponding device is switched on. If EN is driven from a logic-level output, the logic high-level (on) should be referenced to VOUT to avoid intermittently switching the device on.

Shutdown mode: The AS1336A disconnects the output completely from the input.

Low Battery Detection

The low-battery detector circuit can be used to supervise the battery voltage and to generate an error flag when the battery voltage drops below a user-set threshold voltage. The function is active only when the device is enabled, if the device is disabled, the LBO pin is high-impedance.

During normal operation, LBO stays at logic high when the voltage at LBI, is above 600mV. It is logic low when the voltage at LBI goes below 600 mV.

The battery voltage, at which the detection circuit switches, can be programmed with a resistive divider connected to the LBI pin.

$$R1 = R2 ((V_{DETECT} / 600mV) - 1) \quad (EQ 2)$$

Where: V_{DETECT} equals the threshold voltage for the battery voltage where a low battery flag should be signaled.

Note: If the low-battery detection circuit is not used, the LBI pin should be connected to GND (or to V_{IN}) and the LBO pin can be left unconnected. Do not let the LBI pin float. The LBI pin has a built-in hysteresis of 25mV.

9 Application Information

The AS1336 is perfectly suited for LED matrix displays, bar-graph displays, instrument-panel meters, dot matrix displays, set-top boxes, white goods, professional audio equipment, medical equipment, industrial controllers to name a few applications.

Along with [Figure 1 on page 1](#), [Figure 27](#) and [Figure 28](#) depict a few of the many applications for which the AS1336 converters are perfectly suited.

Figure 27. AS1336 - Dual Boost Converter, Single AA Cell to 1.8V & 3.3V adjustable Output Voltage

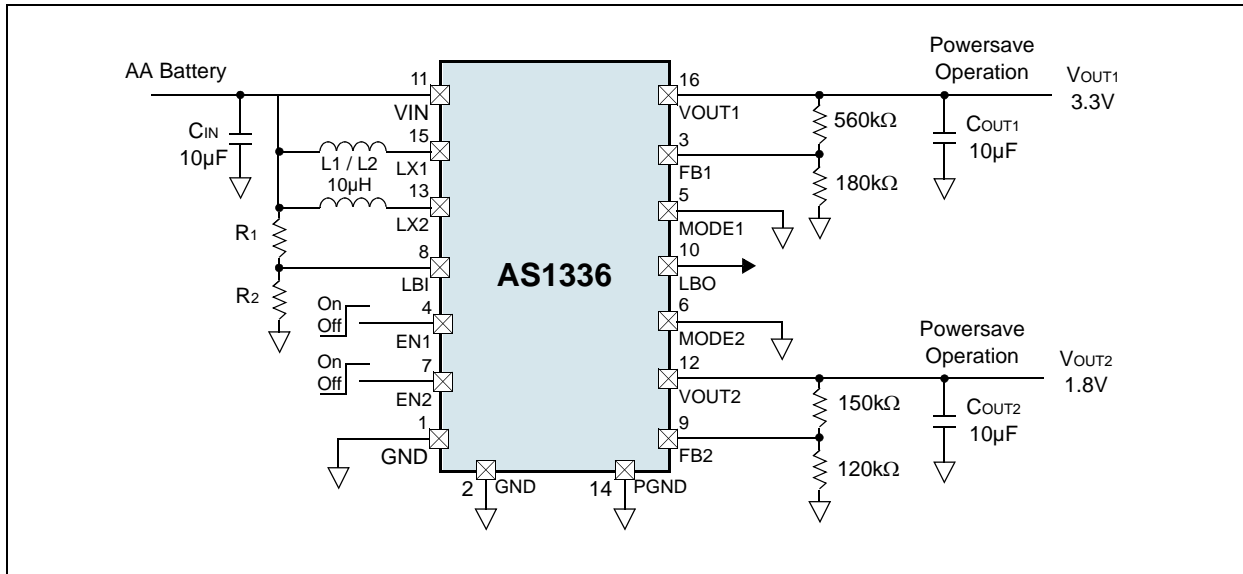
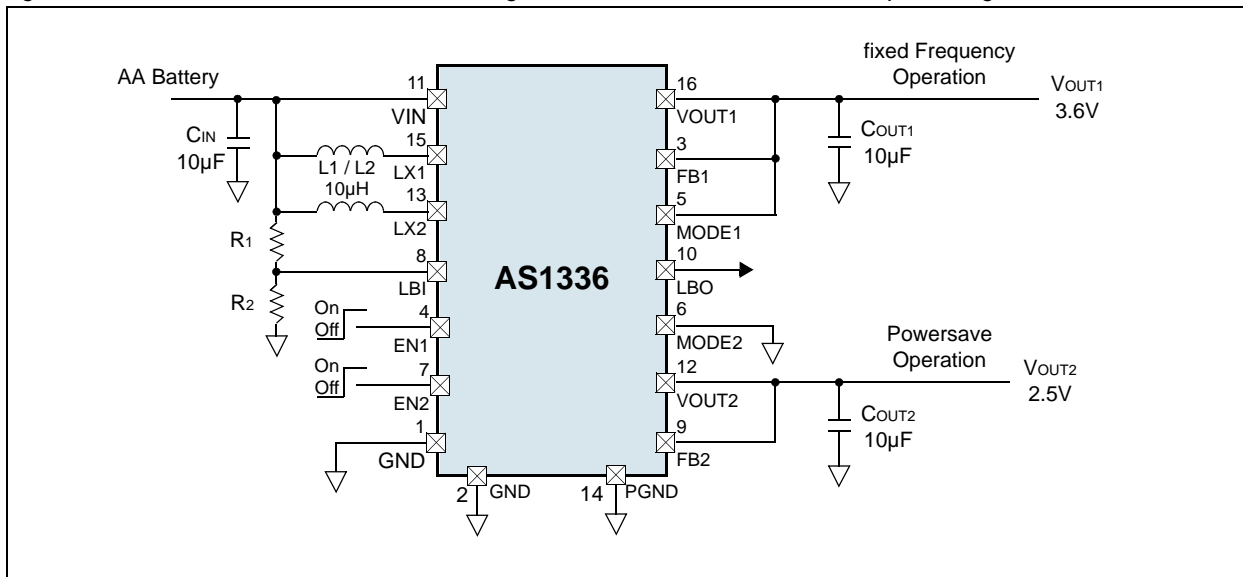

Figure 28. AS1336 - Dual Boost Converter, Single AA Cell to 2.5V & 3.6V fixed Output Voltage



External Component Selection

Inductor Selection

The fast switching frequency (1.2MHz) of the AS1336 allows for the use of small surface mount or chip inductor for the external inductor (see Figure 26 on page 10).

3.3µH is the required minimum value for the external inductor. Larger inductor values allow greater output current capability by reducing the inductor ripple current. Increasing the inductance above 10µH will increase size while providing negligible improvement in output current capability.

The approximate output current capability of the AS1336 versus inductor value is given in:

$$I_{OUT(MAX)} = \eta \cdot \left(I_P - \frac{V_{IN} \cdot D}{f \cdot L \cdot 2} \right) \cdot (1 - D) \quad (EQ 3)$$

Where:

η is the estimated efficiency;

I_P is the peak current limit value (0.6A);

V_{IN} is the input voltage;

D is the steady-state duty ratio = $(V_{OUT} - V_{IN})/V_{OUT}$;

f is the switching frequency (1.2MHz typ);

L is the inductor value.

The inductor current ripple is typically set for 20 to 40% of the maximum inductor current (I_P). High-frequency ferrite core inductor materials reduce frequency dependent power losses compared to less expensive powdered iron types, which result in improved converter efficiency.

The inductor should have low ESR to reduce the I^2R power losses, and must be able to handle the peak inductor current without saturating. Molded chokes and some chip inductors normally do not have enough core to support the peak inductor currents of the AS1336 (850mA typ). To minimize radiated noise, use a toroid, pot core, or shielded bobbin inductor.

Table 4. Recommended External Components

Name	Part Number	Value	Rating	Type	Size	Manufacturer
L1	LQH32PN4R7NN0	4.7µH	1A	216mΩ	3.2x2.5x1.55mm	Murata www.murata.com
	LQH32PN6R8NN0	6.8µH	0.85A	288mΩ	3.2x2.5x1.55mm	
	LQH32PN100MN0	10µH	0.7A	456mΩ	3.2x2.5x1.55mm	
	EPL2010-472ML	4.7µH	0.65A	429mΩ	2.0x2.0x1.0mm	Coilcraft www.coilcraft.com
	EPL2010-682ML	6.8µH	0.57A	512mΩ	2.0x2.0x1.0mm	
	EPL2010-103ML	10µH	0.47A	914mΩ	2.0x2.0x1.0mm	

Capacitor Selection

Low ESR capacitors should be used to minimize V_{OUT} ripple. Multi-layer ceramic capacitors are recommended since they have extremely low ESR and are available in small footprints. A 2.2 to 10 μ F output capacitor is sufficient for most applications. Larger values up to 22 μ F may be used to obtain extremely low output voltage ripple and improve transient response.

An additional phase lead capacitor may be required with output capacitors larger than 10 μ F to maintain acceptable phase margin. X5R and X7R dielectric materials are recommended due to their ability to maintain capacitance over wide voltage and temperature ranges.

Low ESR input capacitors reduce input switching noise and reduce the peak current drawn from the battery. Ceramic capacitors are recommended for input decoupling and should be located as close to the device as is practical. A 4.7 μ F input capacitor is sufficient for most applications. Larger values may be used without limitations.

Table 5. Recommended Capacitors

Name	Part Number	Value	Rated Voltage	Type	Size	Manufacturer
C _{OUT1} , C _{OUT2}	GRM31CR70J106KA01L	10 μ F	6.3V	X7R	1206	Murata www.murata.com
	JMK212BJ226MG-T	22 μ F	6.3V	X5R	0805	Taiyo Yuden www.t-yuden.com

PCB Layout Guidelines

The high-speed operation of the AS1336 requires proper layout for optimum performance.

- A large ground pin copper area will help to lower the device temperature.
- A multi-layer board with a separate ground plane is recommended.
- Traces carrying large currents should be direct.
- Trace area at pin FB should be as small as is practical.
- The lead-length to the battery should be as short as is practical.

10 Package Drawings and Markings

The device is available in a TQFN 3x3mm 16-pin package.

Figure 29. TQFN 3x3mm 16-pin Package

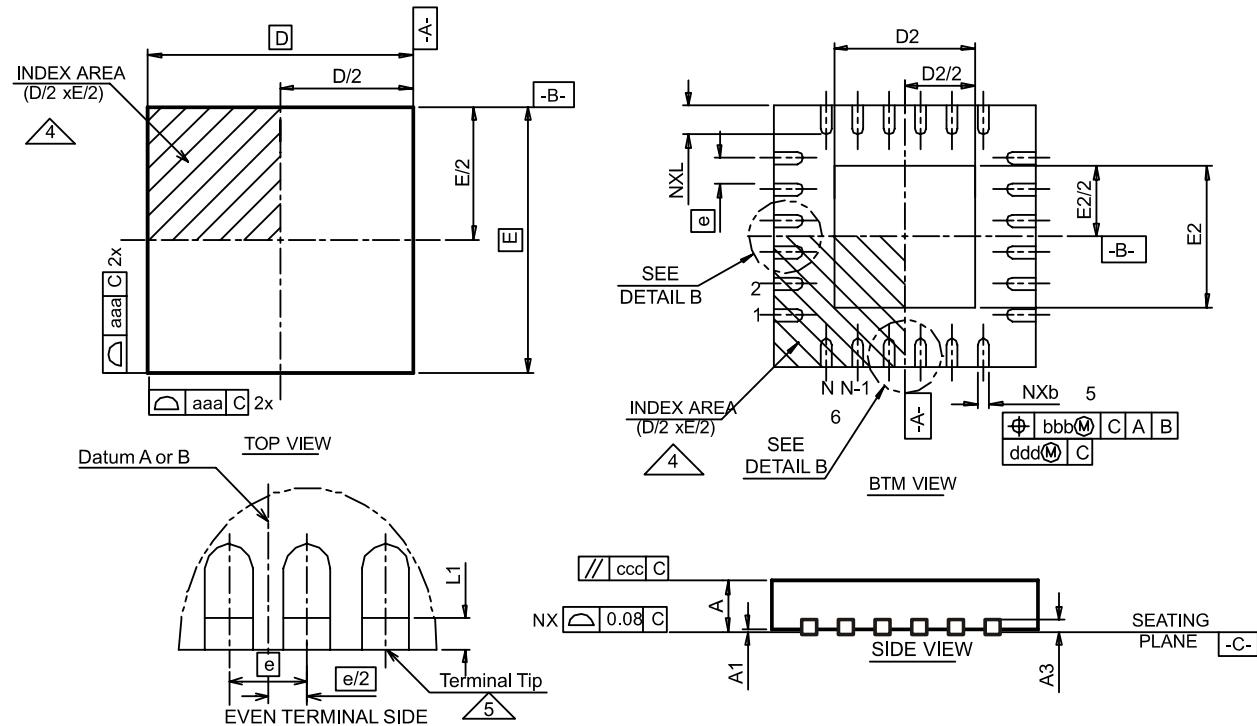

Symbol	Min	Typ	Max	Notes
A	0.55	0.60	0.65	1, 2
A1	0.00	0.02	0.05	1, 2
L	0.30	0.40	0.50	1, 2
L1	0.03		0.15	1, 2
K	0.20			1, 2
aaa		0.10		1, 2
bbb		0.10		1, 2
ccc		0.10		1, 2
ddd		0.05		1, 2

Symbol	Min	Typ	Max	Notes
D BSC		3.00		1, 2
E BSC		3.00		1, 2
D2	1.55	1.70	1.80	1, 2
E2	1.55	1.70	1.80	1, 2
θ	0°		14°	1, 2
b	0.18	0.25	0.30	1, 2, 5
e		0.5		
N		16		1, 2
ND		4		1, 2, 5

Notes:

1. Dimensioning and tolerancing conform to ASME Y14.5M-1994.
2. All dimensions are in millimeters, angle is in degrees.
3. N is the total number of terminals.
4. Terminal #1 identifier and terminal numbering convention shall conform to JESD 95-1 SPP-012. Details of terminal #1 identifier are optional, but must be located within the area indicated. The terminal #1 identifier may be either a mold, embedded metal or mark feature.
5. Dimension b applies to metallized terminal and is measured between 0.15 and 0.30mm from terminal tip.
6. ND refers to the maximum number of terminals on D side.
7. Unilateral coplanarity zone applies to the exposed heat sink slug as well as the terminals.

11 Ordering Information

The device is available as the standard products listed in [Table 6](#).

Table 6. Ordering Information

Ordering Code	Marking	Description	Delivery Form	Package
AS1336A-BQFT	ASSM	Dual, Low Voltage, Micropower DC-DC Step-Up Converters; Battery Disconnect in shutdown	Tape and Reel	TQFN 3x3mm 16-pin

Note: All products are RoHS compliant and Pb-free.

Buy our products or get free samples online at ICdirect: <http://www.austriamicrosystems.com/ICdirect>

For further information and requests, please contact us <mailto:sales@austriamicrosystems.com>
or find your local distributor at <http://www.austriamicrosystems.com/distributor>

Copyrights

Copyright © 1997-2009, austriamicrosystems AG, Tobelbaderstrasse 30, 8141 Unterpremstaetten, Austria-Europe. Trademarks Registered ®. All rights reserved. The material herein may not be reproduced, adapted, merged, translated, stored, or used without the prior written consent of the copyright owner.

All products and companies mentioned are trademarks or registered trademarks of their respective companies.

Disclaimer

Devices sold by austriamicrosystems AG are covered by the warranty and patent indemnification provisions appearing in its Term of Sale. austriamicrosystems AG makes no warranty, express, statutory, implied, or by description regarding the information set forth herein or regarding the freedom of the described devices from patent infringement. austriamicrosystems AG reserves the right to change specifications and prices at any time and without notice. Therefore, prior to designing this product into a system, it is necessary to check with austriamicrosystems AG for current information. This product is intended for use in normal commercial applications. Applications requiring extended temperature range, unusual environmental requirements, or high reliability applications, such as military, medical life-support or life-sustaining equipment are specifically not recommended without additional processing by austriamicrosystems AG for each application. For shipments of less than 100 parts the manufacturing flow might show deviations from the standard production flow, such as test flow or test location.

The information furnished here by austriamicrosystems AG is believed to be correct and accurate. However, austriamicrosystems AG shall not be liable to recipient or any third party for any damages, including but not limited to personal injury, property damage, loss of profits, loss of use, interruption of business or indirect, special, incidental or consequential damages, of any kind, in connection with or arising out of the furnishing, performance or use of the technical data herein. No obligation or liability to recipient or any third party shall arise or flow out of austriamicrosystems AG rendering of technical or other services.



Contact Information

Headquarters

austriamicrosystems AG
Tobelbaderstrasse 30
A-8141 Unterpremstaetten, Austria

Tel: +43 (0) 3136 500 0
Fax: +43 (0) 3136 525 01

For Sales Offices, Distributors and Representatives, please visit:

<http://www.austriamicrosystems.com/contact>