

### SFH 4255



#### Features:

- High Power Infrared LED
- Short switching times
- The product qualification test plan is based on the guidelines of AEC-Q101-REV-C, Stress Test Qualification for Automotive Grade Discrete Semiconductors.

#### Applications

- Infrared Illumination for cameras
- IR data transmission
- Sensor technology

#### Notes

Depending on the mode of operation, these devices emit highly concentrated non visible infrared light which can be hazardous to the human eye. Products which incorporate these devices have to follow the safety precautions given in IEC 60825-1 and IEC 62471.

#### Ordering Information

Type:	Radiant Intensity $I_e$ [mW/sr] $I_F= 100 \text{ mA}, t_p= 20 \text{ ms}$	Ordering Code
SFH 4255	20 ( $\geq 10$ )	Q65110A2467
SFH 4255-S	16 ... 32	Q65111A9683

*Note:* Measured at a solid angle of  $\Omega = 0.01 \text{ sr}$

**Maximum Ratings** ( $T_A = 25\text{ °C}$ )

Parameter	Symbol	Values	Unit
Operation and storage temperature range	$T_{op}; T_{stg}$	-40 ... 100	°C
Reverse voltage	$V_R$	5	V
Forward current	$I_F$	100	mA
Surge current ( $t_p = 200\text{ }\mu\text{s}$ , $D = 0$ )	$I_{FSM}$	1	A
Power consumption	$P_{tot}$	180	mW
ESD withstand voltage (acc. to ANSI/ ESDA/ JEDEC JS-001 - HBM)	$V_{ESD}$	2	kV
Thermal resistance junction - ambient <sup>1) page 12</sup>	$R_{thJA}$	450	K / W
Thermal resistance junction - soldering point <sup>2) page 12</sup>	$R_{thJS}$	200	K / W

**Characteristics** ( $T_A = 25\text{ °C}$ )

Parameter		Symbol	Values	Unit
Peak wavelength ( $I_F = 100\text{ mA}$ , $t_p = 20\text{ ms}$ )	(typ)	$\lambda_{peak}$	860	nm
Centroid wavelength ( $I_F = 100\text{ mA}$ , $t_p = 20\text{ ms}$ )	(typ)	$\lambda_{centroid}$	850	nm
Spectral bandwidth at 50% of $I_{max}$ ( $I_F = 100\text{ mA}$ , $t_p = 20\text{ ms}$ )	(typ)	$\Delta\lambda$	30	nm
Half angle	(typ)	$\varphi$	$\pm 60$	°
Dimensions of active chip area	(typ)	L x W	0.3 x 0.3	mm x mm
Rise and fall time of $I_e$ ( 10% and 90% of $I_{e\ max}$ ) ( $I_F = 100\text{ mA}$ , $R_L = 50\text{ }\Omega$ )	(typ)	$t_r, t_f$	12	ns
Forward voltage ( $I_F = 100\text{ mA}$ , $t_p = 20\text{ ms}$ )	(typ (max))	$V_F$	1.5 ( $\leq 1.8$ )	V
Forward voltage ( $I_F = 1\text{ A}$ , $t_p = 100\text{ }\mu\text{s}$ )	(typ (max))	$V_F$	2.4 ( $\leq 3$ )	V
Reverse current ( $V_R = 5\text{ V}$ )		$I_R$	not designed for reverse operation	$\mu\text{A}$
Total radiant flux ( $I_F = 100\text{ mA}$ , $t_p = 20\text{ ms}$ )	(typ)	$\Phi_e$	60	mW

Parameter		Symbol	Values	Unit
Temperature coefficient of $I_e$ or $\Phi_e$ ( $I_F = 100$ mA, $t_p = 20$ ms)	(typ)	$TC_I$	-0.5	% / K
Temperature coefficient of $V_F$ ( $I_F = 100$ mA, $t_p = 20$ ms)	(typ)	$TC_V$	-0.7	mV / K
Temperature coefficient of wavelength ( $I_F = 100$ mA, $t_p = 20$ ms)	(typ)	$TC_\lambda$	0.3	nm / K

### Grouping ( $T_A = 25$ °C)

Group	Min Radiant Intensity	Max Radiant Intensity	Typ Radiant Intensity
	$I_F = 100$ mA, $t_p = 20$ ms $I_{e, \min}$ [mW / sr]	$I_F = 100$ mA, $t_p = 20$ ms $I_{e, \max}$ [mW / sr]	$I_F = 1$ A, $t_p = 25$ $\mu$ s $I_{e, \text{typ}}$ [mW / sr]
SFH 4255-R	10	20	120
SFH 4255-S	16	32	190

Note: measured at a solid angle of  $\Omega = 0.01$  sr

Only one group in one packing unit (variation lower 2:1).

### Relative Spectral Emission <sup>3) page 12</sup>

$$I_{\text{rel}} = f(\lambda), T_A = 25^\circ\text{C}$$

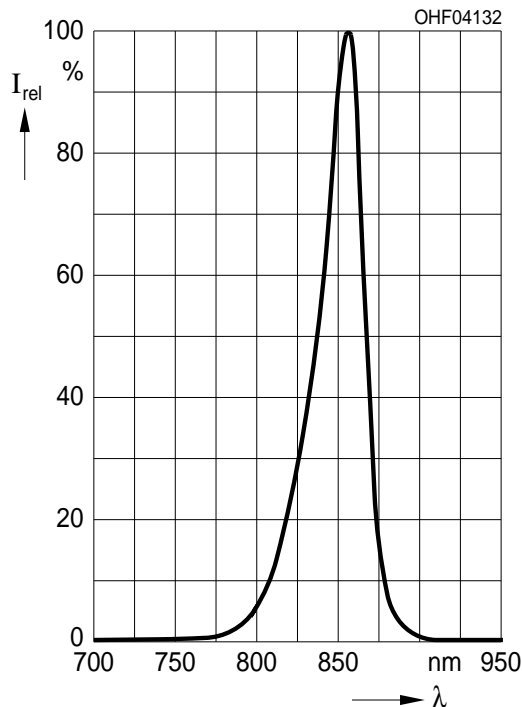

### Radiant Intensity <sup>3) page 12</sup>

$$I_e / I_e(100 \text{ mA}) = f(I_F), \text{ single pulse, } t_p = 25 \mu\text{s}, T_A = 25^\circ\text{C}$$

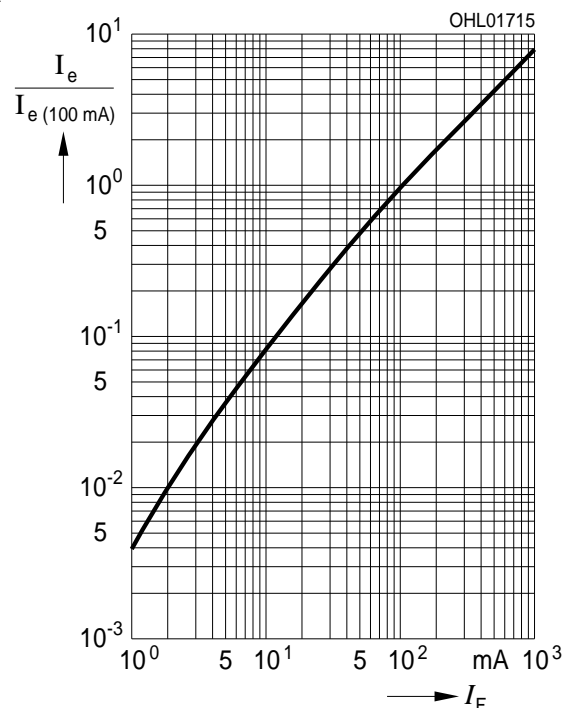

**Max. Permissible Forward Current**

$I_F = f(T_A)$ ,  $R_{thJA} = 450 \text{ K/W}$

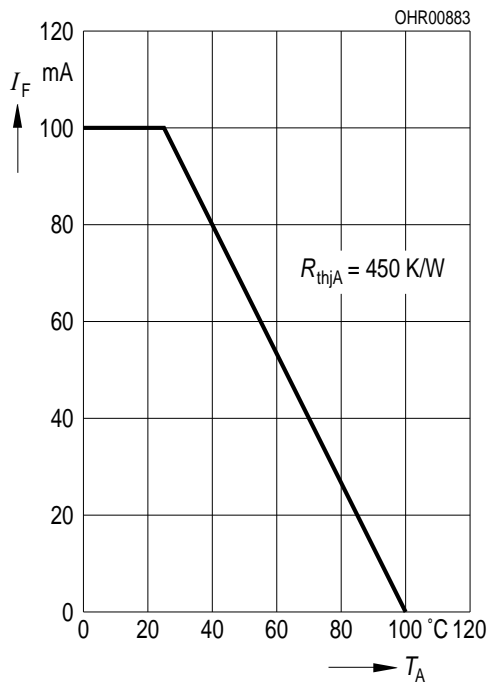

**Forward Current** <sup>3) page 12</sup>

$I_F = f(V_F)$ , single pulse,  $t_p = 100 \mu\text{s}$ ,  $T_A = 25^\circ\text{C}$

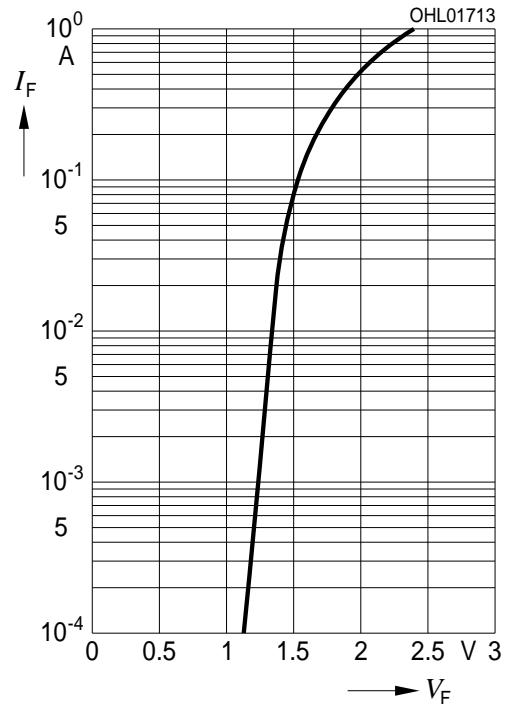

**Permissible Pulse Handling Capability**

$I_F = f(t_p)$ ,  $T_A = 25^\circ\text{C}$ , duty cycle  $D = \text{parameter}$

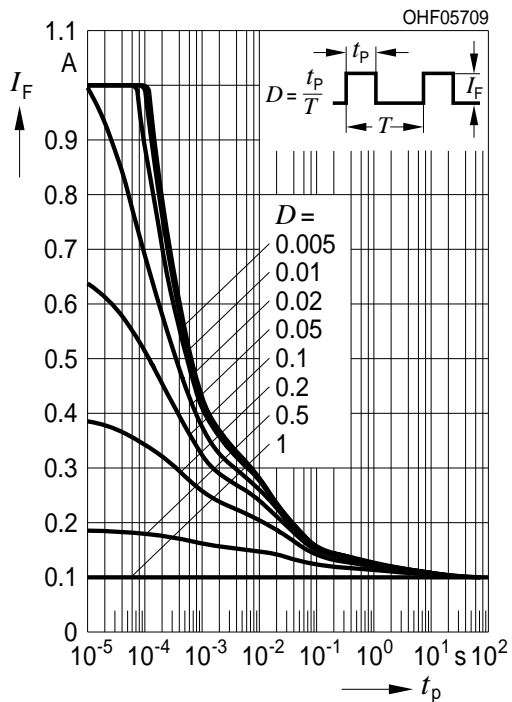

**Permissible Pulse Handling Capability**

$I_F = f(t_p)$ ,  $T_A = 85^\circ\text{C}$ , duty cycle  $D = \text{parameter}$

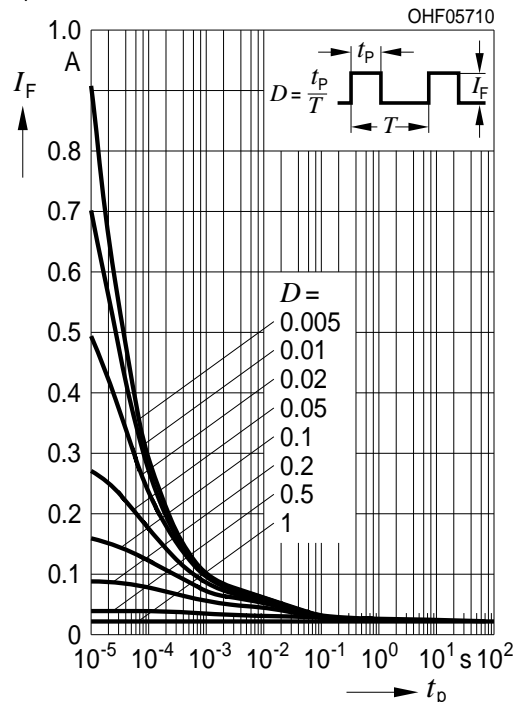

**Radiation Characteristics** <sup>3) page 12</sup>

$I_{rel} = f(\phi), T_A = 25^\circ\text{C}$

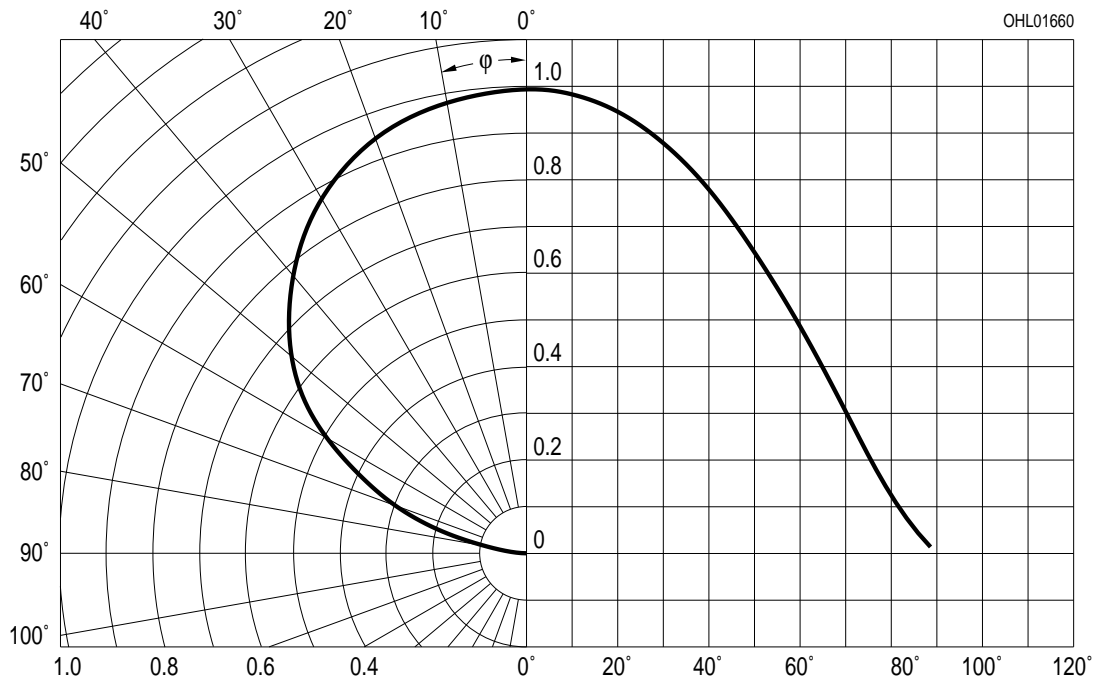

**Package Outline**

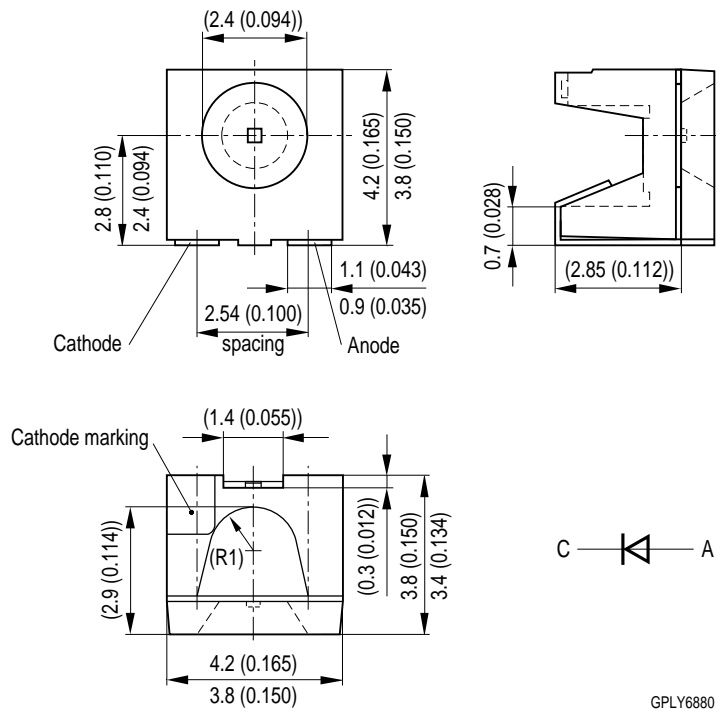

*Dimensions in mm (inch).*

**Package**  
SIDELED

**Approximate Weight:**

76 mg

**Recommended Solder Pad**

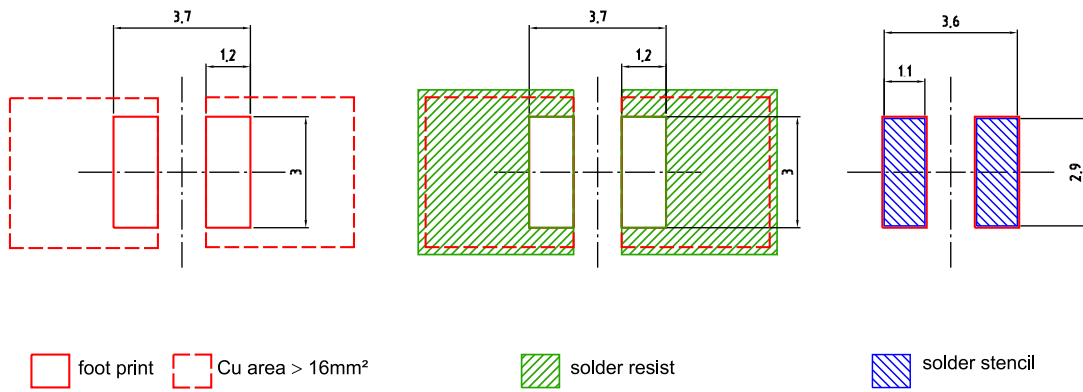

Component Location on Pad

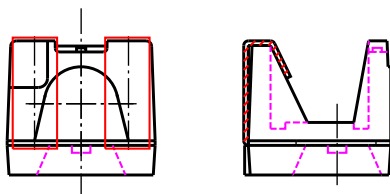

Dimensions in mm.

E062.3010.06 -02

### Reflow Soldering Profile

Product complies to MSL Level 2 acc. to JEDEC J-STD-020D.01

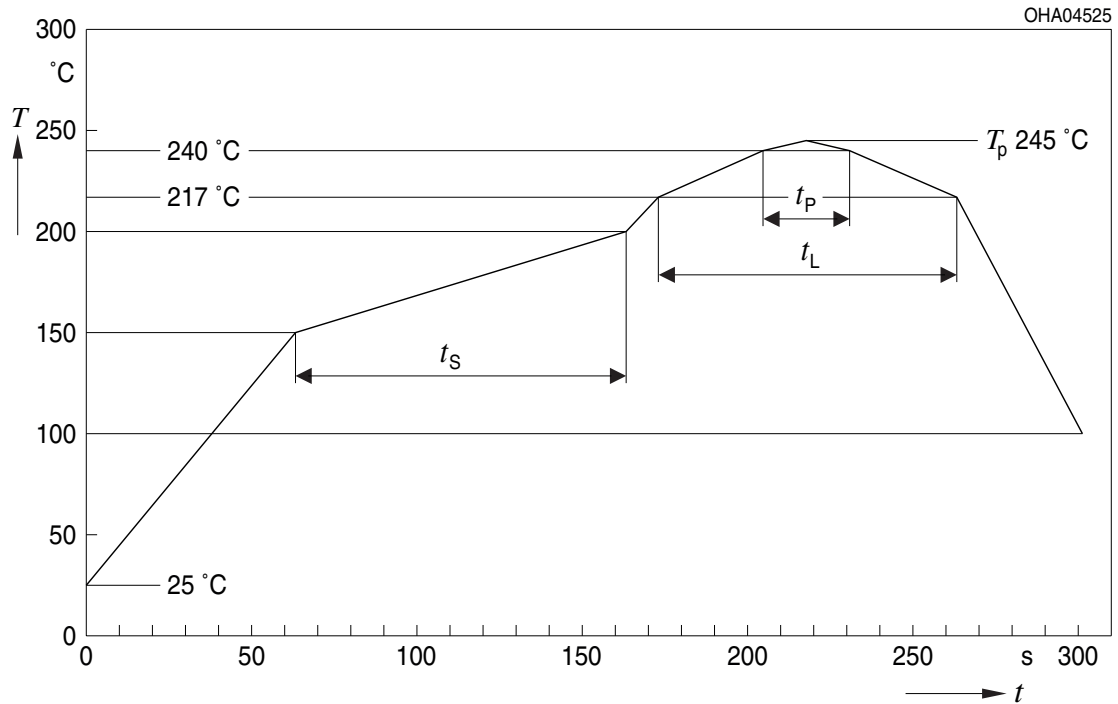

Profil-Charakteristik Profile Feature	Symbol Symbol	Pb-Free (SnAgCu) Assembly			Einheit Unit
		Minimum	Recommendation	Maximum	
Ramp-up Rate to Preheat*) 25 °C to 150 °C			2	3	K/s
Time $t_S$ $T_{Smin}$ to $T_{Smax}$	$t_S$	60	100	120	s
Ramp-up Rate to Peak*) $T_{Smax}$ to $T_P$			2	3	K/s
Liquidus Temperature	$T_L$	217			°C
Time above Liquidus temperature	$t_L$		80	100	s
Peak Temperature	$T_P$	245			°C
Time within 5 °C of the specified peak temperature $T_P - 5$ K	$t_P$	10	20	30	s
Ramp-down Rate* $T_P$ to 100 °C			3	4	K/s
Time 25 °C to $T_P$				480	s

All temperatures refer to the center of the package, measured on the top of the component  
 \* slope calculation  $DT/Dt$ :  $Dt$  max. 5 s; fulfillment for the whole T-range

Taping

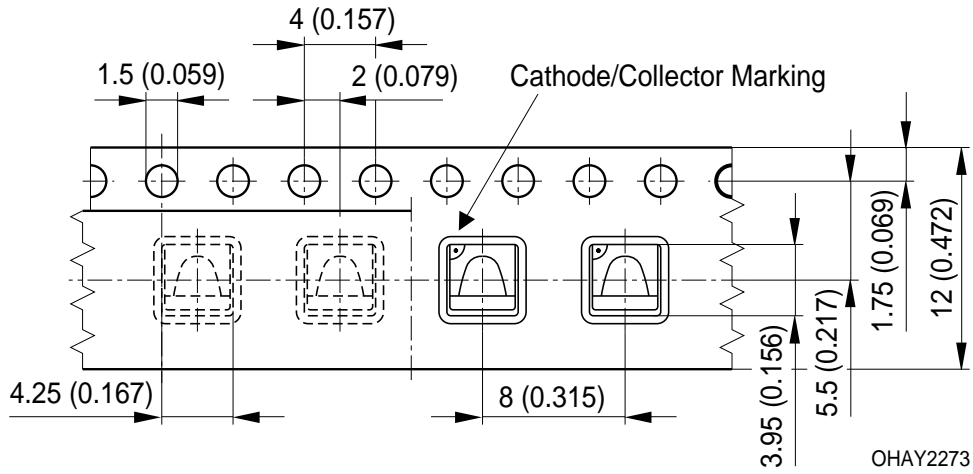

Dimensions in mm (inch).

Tape and Reel

12 mm tape with 2000 pcs. on  $\varnothing$  330 mm reel

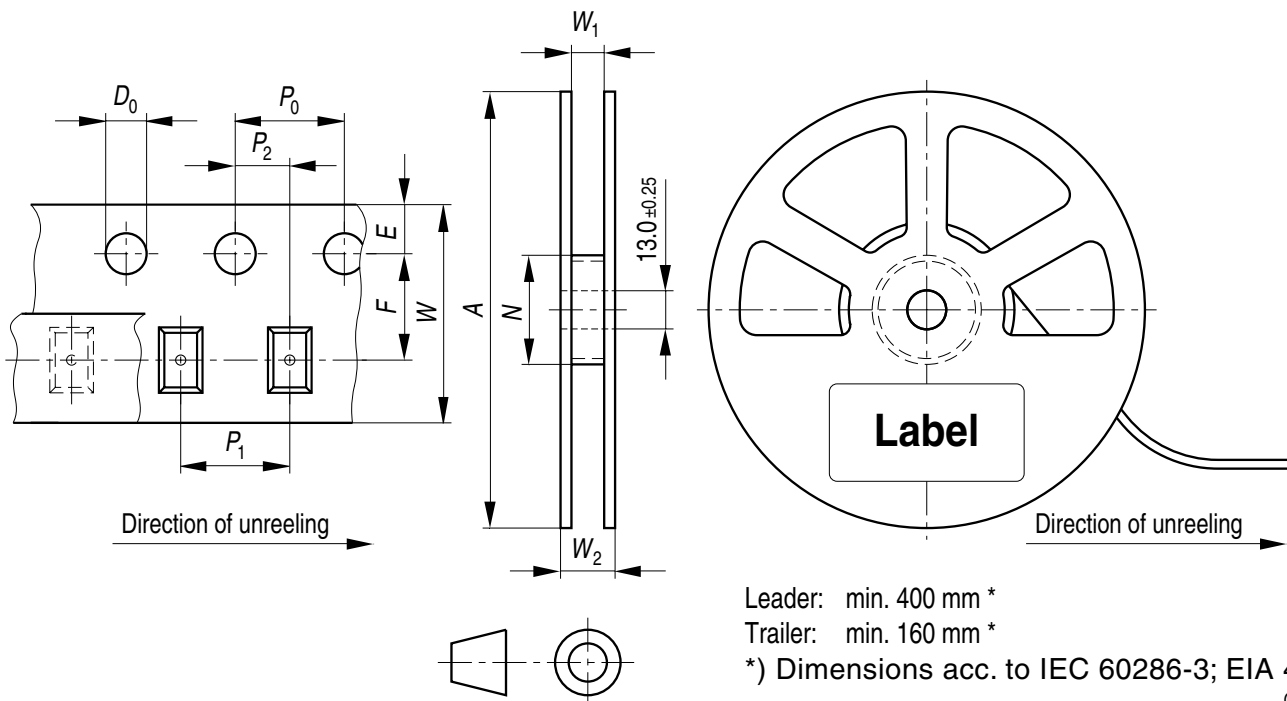

Leader: min. 400 mm \*

Trailer: min. 160 mm \*

\*) Dimensions acc. to IEC 60286-3; EIA 481-D

OHAY0324



## Tape dimensions [mm]

W	P <sub>0</sub>	P <sub>1</sub>	P <sub>2</sub>	D <sub>0</sub>	E	F
12 + 0.3 / - 0.1	4 ± 0.1	4 ± 0.1 or 8 ± 0.1	2 ± 0.05	1.5 ± 0.1	1.75 ± 0.1	5.5 ± 0.05

## Reel dimensions [mm]

A	W	N <sub>min</sub>	W <sub>1</sub>	W <sub>2max</sub>
330	12	60	12.4 + 2	18.4

## Barcode-Product-Label (BPL)



## Dry Packing Process and Materials



## Note:

Moisture-sensitive product is packed in a dry bag containing desiccant and a humidity card. Regarding dry pack you will find further information in the internet. Here you will also find the normative references like JEDEC.

## Transportation Packing and Materials

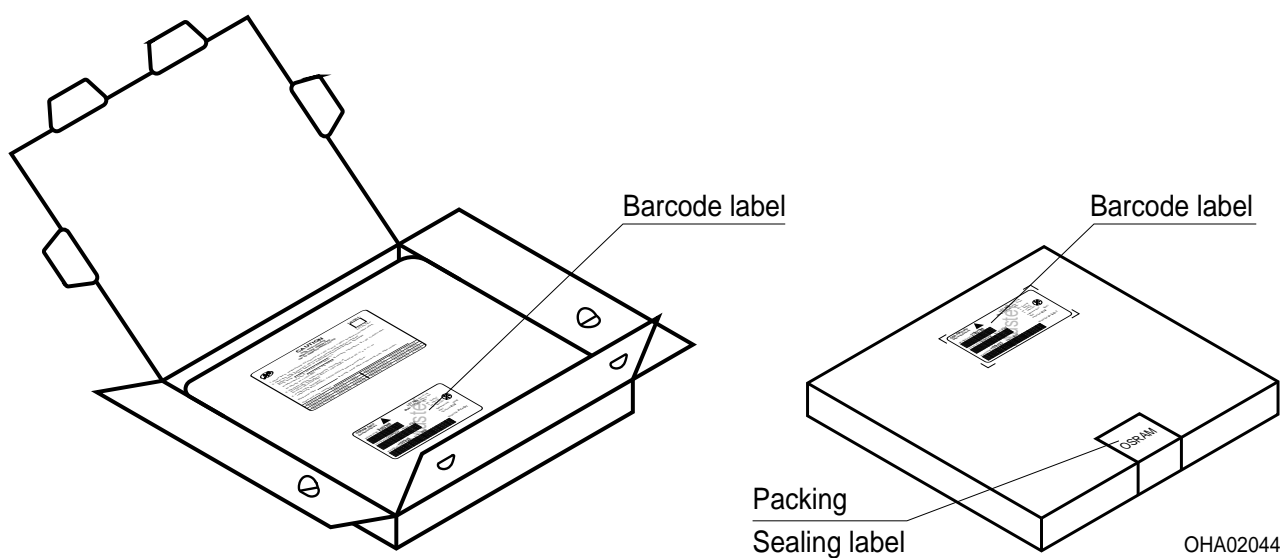

## Dimensions of transportation box in mm

Width	Length	Height
349 ± 5	349 ± 5	33 ± 5

**Disclaimer**

Language english will prevail in case of any discrepancies or deviations between the two language wordings.

**Attention please!**

The information describes the type of component and shall not be considered as assured characteristics.

Terms of delivery and rights to change design reserved. Due to technical requirements components may contain dangerous substances.

For information on the types in question please contact our Sales Organization.

If printed or downloaded, please find the latest version in the Internet.

**Packing**

Please use the recycling operators known to you. We can also help you – get in touch with your nearest sales office.

By agreement we will take packing material back, if it is sorted. You must bear the costs of transport. For packing material that is returned to us unsorted or which we are not obliged to accept, we shall have to invoice you for any costs incurred.

**Components used in life-support devices or systems must be expressly authorized for such purpose!**

Critical components\* may only be used in life-support devices\*\* or systems with the express written approval of OSRAM OS.

\*) A critical component is a component used in a life-support device or system whose failure can reasonably be expected to cause the failure of that life-support device or system, or to affect its safety or the effectiveness of that device or system.

\*\*) Life support devices or systems are intended (a) to be implanted in the human body, or (b) to support and/or maintain and sustain human life. If they fail, it is reasonable to assume that the health and the life of the user may be endangered.

**Glossary**

- 1) **Thermal resistance:** junction -ambient, mounted on PC-board (FR4), padsize 16 mm<sup>2</sup> each
- 2) **Thermal resistance:** junction - soldering point, of the device only, mounted on an ideal heatsink (e.g. metal block)
- 3) **Typical Values:** Due to the special conditions of the manufacturing processes of LED, the typical data or calculated correlations of technical parameters can only reflect statistical figures. These do not necessarily correspond to the actual parameters of each single product, which could differ from the typical data and calculated correlations or the typical characteristic line. If requested, e.g. because of technical improvements, these typ. data will be changed without any further notice.

**Published by OSRAM Opto Semiconductors GmbH**  
**Leibnizstraße 4, D-93055 Regensburg**  
**[www.osram-os.com](http://www.osram-os.com) © All Rights Reserved.**

EU RoHS and China RoHS compliant product



此产品符合欧盟 RoHS 指令的要求；  
按照中国的相关法规和标准，不含有毒有害物质或元素。