

POWER COMBICON plugs with a 7.62 mm pitch

PC 5 plugs

The new PC 5 plug connection system is the logical further development of the classic POWER COMBICON PC 4. With a pitch of 7.62 mm all PC 5 plugs provide a nominal voltage of 600 V to UL. The maximum permissible current is 41 A. An integrated double steel spring ensures additional contact reliability, especially in the event of extreme power or temperature fluctuations.

PC 5 is designed for 2 to 12 positions and the screw connection of stranded conductors up to 6 mm² is established in accordance with the proven cage principle. A screw flange for securing the connection of the plug to the header is also included in the PC 5 range.

Note:

PC 5 plugs are compatible with the current PC 4 headers.



COMBICON Select

The COMBICON search engine with CAD downloading





COMBICON Select – the printed circuit board connection software supports your workflow from the PCB and housing layout to the ordering process with:

- Systematic and fast selection of products
- Universal Internet aided engineering with extensive CAD downloading
- Easy-to-use e-shopping functions.

select.phoenixcontact.com/combicon

POWER COMBICON plugs
PC 5/...-ST-7,62
7.62 mm Pitch



Description	No. of pos.	Dim. a [mm]	Type	Order No.	Pcs./Pkt.
POWER COMBICON plugs, 7.62 mm pitch, color: green	2	7.62	PC 5/2-ST-7,62	19 75 58 7	50
	3	15.24	PC 5/3-ST-7,62	19 75 59 0	
	4	22.86	PC 5/4-ST-7,62	19 75 60 0	
	5	30.48	PC 5/5-ST-7,62	19 75 61 3	
	6	38.10	PC 5/6-ST-7,62	19 75 62 6	
	7	45.72	PC 5/7-ST-7,62	19 75 63 9	
	8	53.34	PC 5/8-ST-7,62	19 75 64 2	
	9	60.96	PC 5/9-ST-7,62	19 75 65 5	
	10	68.58	PC 5/10-ST-7,62	19 75 66 8	
	11	76.20	PC 5/11-ST-7,62	19 75 67 1	
	12	83.82	PC 5/12-ST-7,62	19 75 68 4	
	(1) Coding profile, is inserted into the slot on the plug and header, red insulating material			CP-HCC 4	
(2) Screwdriver			SZK PZ 1	12 06 45 0	10
(3) Marker card, with 12 pcs., 10-section marker strips, white self-adhesive, for 120 terminal blocks			SK 7,62/3,8 (see COMBICON catalog)		

Technical data

Dimensions

Pitch	[mm]	7.62
Hole diameter	[mm]	—
Pin dimensions	[mm]x[mm]	—

Technical data in acc. with IEC/ DIN VDE

Insulating material group	—	I	II / 2
Surge voltage category / contamination class	—/—	III / 3	III / 2
Rated voltage	[V]	800	1000
Rated surge voltage	[kV]	8	8
Nominal current / cross section	[A]/[mm ²]		41 ¹⁾ / 10
Maximum load current / cross section	[A]/[mm ²]		41 ¹⁾ / 10

Connection capacity

Solid / stranded / conductor sizes	[mm ²]/[mm ²]/AWG	0.2 - 10 / 0.2 - 6 / 24 - 8
Stranded with ferrule without / with plastic sleeve	[mm ²]	0.25 - 6 / 0.25 - 4

Multiple connection (2 conductors with same cross section)

Solid / stranded	[mm ²]	10
Stranded with ferrule without plastic sleeve	[mm ²]	A4
Stranded with TWIN ferrule with plastic sleeve	[mm ²]	M 3

Stripping length

Internal cylindrical gauge (IEC 60 947-1)	—	PA
Thread	—	V0

Torque

Insulating material	[Nm]	—
---------------------	------	---

Insulating material

Inflammability class in acc. with UL 94

Approval data (UL/CUL and CSA)

Nominal voltage / current / conductor sizes	UL/CUL: [V]/[A]/AWG	—
	CSA: [V]/[A]/AWG	—

see description

7.62

—

—

III / 3	III / 2	II / 2
800	1000	1000
8	8	6
	41 ¹⁾ / 10	
	41 ¹⁾ / 10	

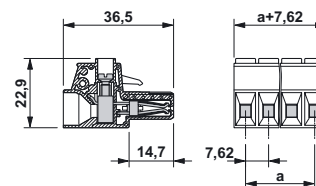

0.2 - 10 / 0.2 - 6 / 24 - 8
0.25 - 6 / 0.25 - 4

¹⁾ Observe derating curve



POWER COMBICON plugs
PC 5/...-STF-7,62
7.62 mm Pitch



Description	No. of pos.	Dim. a [mm]	Type	Order No.	Pcs./Pkt.
POWER COMBICON plugs, 7.62 mm pitch, color: green, with screw flange	2	7.62	PC 5/2-STF-7,62	19 75 69 7	50
	3	15.24	PC 5/3-STF-7,62	19 75 70 7	
	4	22.86	PC 5/4-STF-7,62	19 75 71 0	
	5	30.48	PC 5/5-STF-7,62	19 75 73 2	
	6	38.10	PC 5/6-STF-7,62	19 75 73 6	
	7	45.72	PC 5/7-STF-7,62	19 75 74 9	
	8	53.34	PC 5/8-STF-7,62	19 75 75 2	
	9	60.96	PC 5/9-STF-7,62	19 75 76 5	
	10	68.58	PC 5/10-STF-7,62	19 75 77 8	
	11	76.20	PC 5/11-STF-7,62	19 75 78 1	
	12	83.82	PC 5/12-STF-7,62	19 75 79 4	
	(1) Coding profile , is inserted into the slot on the plug and header, red insulating material			CP-HCC 4	
(2) Screwdriver			SZK PZ 1	12 06 45 0	10
(3) Marker card , with 12 pcs., 10-section marker strips, white self-adhesive, for 120 terminal blocks			SK 7,62/3,8 (see COMBICON catalog)		

Technical data

Dimensions		see description		
Pitch	[mm]	7.62		
Hole diameter	[mm]	—		
Pin dimensions	[mm]x[mm]	—		
Technical data in acc. with IEC/ DIN VDE				
Insulating material group	—		I	
Surge voltage category / contamination class	—/—	III / 3	III / 2	II / 2
Rated voltage	[V]	800	1000	1000
Rated surge voltage	[kV]	8	8	6
Nominal current / cross section	[A]/[mm ²]		41 ¹⁾ / 10	
Maximum load current / cross section	[A]/[mm ²]		41 ¹⁾ / 10	
Connection capacity				
Solid / stranded / conductor sizes	[mm ²]/[mm ²]/AWG	0.2 - 10 / 0.2 - 6 / 24 - 8		
Stranded with ferrule without / with plastic sleeve	[mm ²]	0.25 - 6 / 0.25 - 4		
Multiple connection (2 conductors with same cross section)				
Solid / stranded	[mm ²]			
Stranded with ferrule without plastic sleeve	[mm ²]			
Stranded with TWIN ferrule with plastic sleeve	[mm ²]			
Stripping length	[mm]		10	
Internal cylindrical gauge (IEC 60 947-1)	—		A4	
Thread	—		M 3	
Torque	[Nm]			
Insulating material			PA	
Inflammability class in acc. with UL 94			V0	
Approval data (UL/CUL and CSA)				
Nominal voltage / current / conductor sizes	UL/CUL: [V]/[A]/AWG CSA: [V]/[A]/AWG		—	
			—	

¹⁾ Observe derating curve

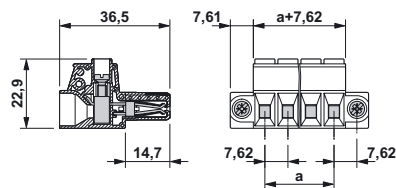

POWER COMBICON plugs with screw flange and shield, 7.62 mm pitch

PC 5/...-STF-SH-7,62

The PC plug with shield provides a professional connection of the braided shield to prevent electrical interference. The largest possible contact of the shielded cable is decisive for compliance with EMC requirements and for high-quality shielding. To ensure optimum connection of the conductor with the shield, conventional metal cable clamps should be used (see photo). The shielded cable may also be connected to the engaged shield with a plastic cable tie. The screw integrated in the plug flange guarantees a perfect connection between the shroud and the metal front.

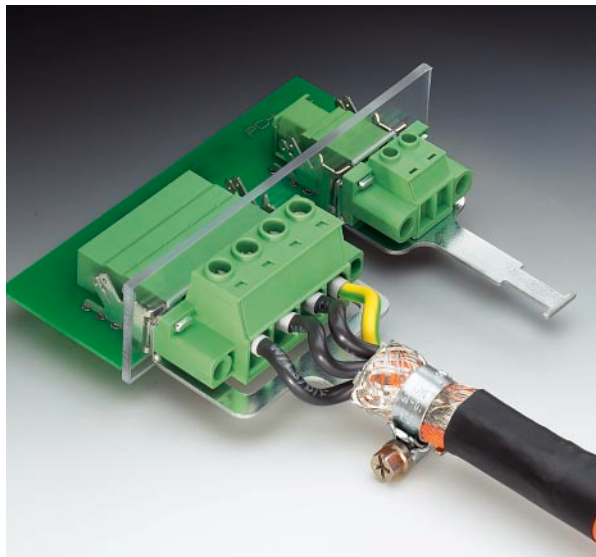

POWER COMBICON PCB-SHIELD

If the housing wall or front panel is not conductive, it is possible to route the shielding function on to POWER COMBICON PCB-SHIELD directly on the PCB via the flange screw (see photo). The 6.3/2.8 x 0.8 mm slip-on connection can then also be used to reach the next grounding point along the shortest possible route.

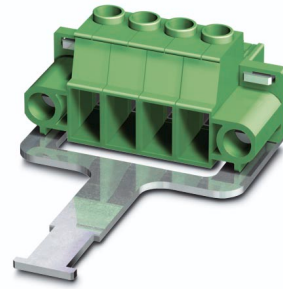

POWER COMBICON plugs
PC 5/...-STF-SH-7,62
7.62 mm Pitch



Description	No. of pos.	Dim. a [mm]	Type	Order No.	Pcs./Pkt.
POWER COMBICON plugs, 7.62 mm pitch, color: green, with screw flange and shield	4	22.86	PC 5/4-STF-SH-7,62	19 75 80 4	25
(1) Coding profile , is inserted into the slot on the plug and header, red insulating material			CP-HCC 4	16 00 02 7	100
(2) Screwdriver			SZK PZ 1	12 06 45 0	10
(3) Marker card , with 12 pcs., 10-section marker strips, white self-adhesive, for 120 terminal blocks			SK 7,62/3,8 (see COMBICON catalog)		
Technical data					
Dimensions					
Pitch		[mm]	see description		
Hole diameter		[mm]	7.62		
Pin dimensions		[mm]x[mm]	—		
Technical data in acc. with IEC/ DIN VDE					
Insulating material group		—		I	
Surge voltage category / contamination class		—/—	III / 3	III / 2	II / 2
Rated voltage		[V]	800	1000	1000
Rated surge voltage		[kV]	8	8	6
Nominal current / cross section		[A]/[mm ²]		41 ¹⁾ / 10	
Maximum load current / cross section		[A]/[mm ²]		41 ¹⁾ / 10	
Connection capacity					
Solid / stranded / conductor sizes		[mm ²]/[mm ²]/AWG	0.2 - 10 / 0.2 - 6 / 24 - 8		
Stranded with ferrule without / with plastic sleeve		[mm ²]	0.25 - 6 / 0.25 - 4		
Multiple connection (2 conductors with same cross section)					
Solid / stranded		[mm ²]			
Stranded with ferrule without plastic sleeve		[mm ²]			
Stranded with TWIN ferrule with plastic sleeve		[mm ²]			
Stripping length		[mm]	10		
Internal cylindrical gauge (IEC 60 947-1)		—	A4		
Thread		—	M 3		
Torque		[Nm]			
Insulating material					
Inflammability class in acc. with UL 94			PA		
Approval data (UL/CUL and CSA)					
Nominal voltage / current / conductor sizes		UL/CUL: [V]/[A]/AWG	—		
		CSA: [V]/[A]/AWG	—		

¹⁾ Observe derating curve

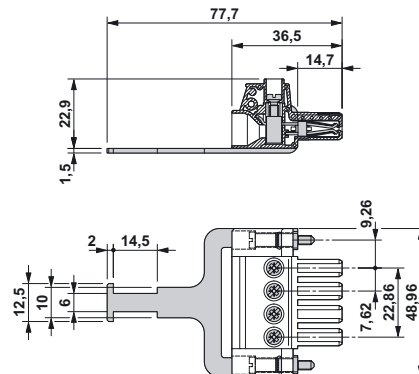

**POWER COMBICON headers with
POWER COMBICON PCB-SHIELD
PC 4/...-G-7,62
7.62 mm Pitch**

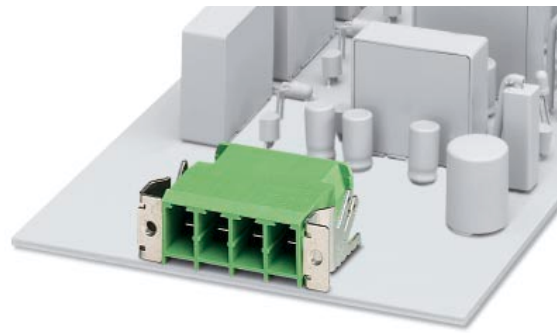

Description	No. of pos.	Dim. a [mm]	Type	Order No.	Pcs./Pkt.
POWER COMBICON headers, 7.62 mm pitch, color: green	2	7.62	PC 4/2-G-7,62	18 04 79 7	50
	4	22.86	PC 4/4-G-7,62	18 04 81 0	50
(1) Coding profile , is inserted into the slot on the plug and header, red insulating material			CP-HCC 4	16 00 02 7	100
(2) Shroud , connects the shield from the flange screw of the plug to the PCB with a 6.3/2.8 x 0.8 mm slip-on connection			POWER COMBICON PCB-SHIELD	19 68 38 7	50
(3) Marker card , with 12 pcs., 10-section marker strips, white self-adhesive, for 120 terminal blocks			SK 7,62/3,8 (see COMBICON catalog)		
Technical data					
Dimensions					
Pitch		[mm]	see description		
Hole diameter		[mm]	7.62		
Pin dimensions		[mm]x[mm]	1.3		
			1 x 0.8		
Technical data in acc. with IEC/ DIN VDE					
Insulating material group		—		IIIa	II / 2
Surge voltage category / contamination class		—/—	III / 3	III / 2	630
Rated voltage		[V]	400	630	630
Rated surge voltage		[kV]	6	6	6
Nominal current / cross section		[A]/[mm ²]		20 ¹⁾ / —	
Maximum load current / cross section		[A]/[mm ²]		20 ¹⁾ / —	
Insulating material					
Inflammability class in acc. with UL 94			PBT		
Approval data (UL/CUL and CSA)					
Nominal voltage / current / conductor sizes		UL/CUL: [V]/[A]/AWG	—		
		CSA: [V]/[A]/AWG	—		

¹⁾ With PC 4/... plug, 41 A with PC 5/... plug

