

# UM10490

## User manual for the BGU7004 GPS Front end evaluation board

Rev. 1.0 — 14 June 2011

User manual

### Document information

Info	Content
<b>Keywords</b>	LNA, FE, GPS, SAW, BGU7004, Mobile Phones Co-habitation
<b>Abstract</b>	This document explains the BGU7004 AEC-Q100 qualified GPS front-end evaluation board



**Revision history**

Rev	Date	Description
1.0	20110614	First release

**Contact information**

For additional information, please visit: <http://www.nxp.com>

For sales office addresses, please send an email to: [salesaddresses@nxp.com](mailto:salesaddresses@nxp.com)

## 1. Introduction

NXP Semiconductors' BGU7004 AEC-Q100 qualified Global Positioning System Front-End Evaluation Board (BGU7004 GPS FE EVB) is designed to evaluate the performance of the GPS front-end using:

- NXP Semiconductors' BGU7004 AEC-Q100 qualified GPS low-noise amplifier;
- a matching inductor;
- a decoupling capacitor;
- two identical GPS band-pass filters.

It has a gain of 14.6 dB and a noise figure of 1.8 dB at a current consumption of 4.8mA. Its superior linearity performance removes interference and noise from co-habitation cellular transmitters, while retaining sensitivity. The front-end components occupy a total area of approximately 3 x 3 mm.

In this document, the application diagram, board layout, bill of materials, and typical results are given, as well as some explanations on GPS related performance parameters like out-of-band input third-order intercept point O<sub>IIP3</sub>, gain compression under jamming and noise under jamming.

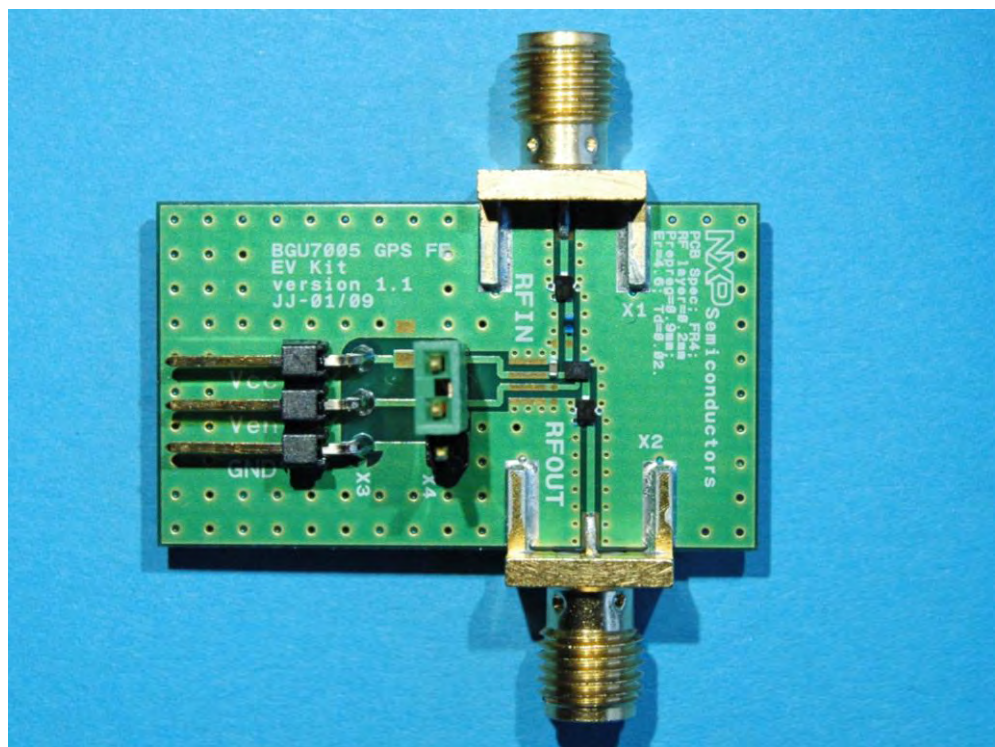

Fig 1. BGU7004 GPS front-end evaluation board

## 2. General description

---

Modern cellular phones have multiple radio systems, so problems like co-habitation are quite common. A GPS receiver implemented in a mobile phone requires the following factors to be taken into account.

All the different transmit signals that are active in a phone can cause problems like intermodulation and compression.

Since the GPS receiver needs to receive signals with an average power level of -130 dBm, sensitivity is very important. Currently there are several GPS chipsets on the market that can be implemented in cell phones, PDAs etc. Although many of these GPS ICs do have integrated LNA front ends, the noise performance, and as a result the system sensitivity is not always adequate. The GPS receiver sensitivity is a measure for how accurate the coordinates are calculated. The GPS signal reception can be improved by a so called GPS front-end, which improves the sensitivity by filtering out the unwanted jamming signals and by amplifying the wanted GPS signal with a low-noise amplifier.

The pre-filters and post filters are needed to improve the overall linearity of the system as well as to avoid overdriving the integrated LNA stage of the GPS receiver.

## 3. BGU7004 GPS front-end evaluation board

---

The BGU7004 front-end evaluation board simplifies the RF evaluation of the BGU7004 GPS LNA applied in a GPS front end, that is often used in mobile cell phones. The evaluation board enables testing of the device RF performance and requires no additional support circuitry. The board is fully assembled with the BGU7004, including the input series inductor, decoupling capacitor as well as two SAW filters to optimize the linearity performance. The board is supplied with two SMA connectors for input and output connection to RF test equipment. The BGU7004 can operate from a 1.5 V to 2.85 V single supply and consumes about 5 mA.

### 3.1 Application Circuit

The circuit diagram of the evaluation board is shown in [Fig 2](#). With jumper JU1 the enable input can be connected either to  $V_{CC}$  or GND.

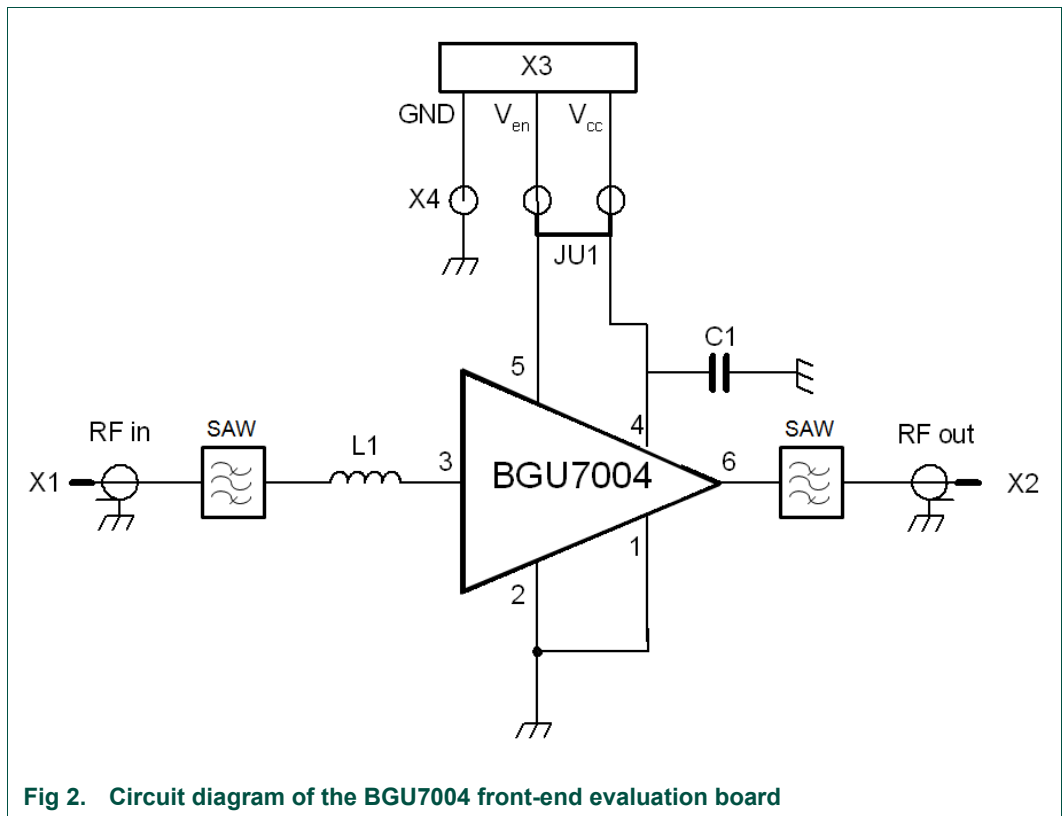

Fig 2. Circuit diagram of the BGU7004 front-end evaluation board

### 3.2 Board Layout

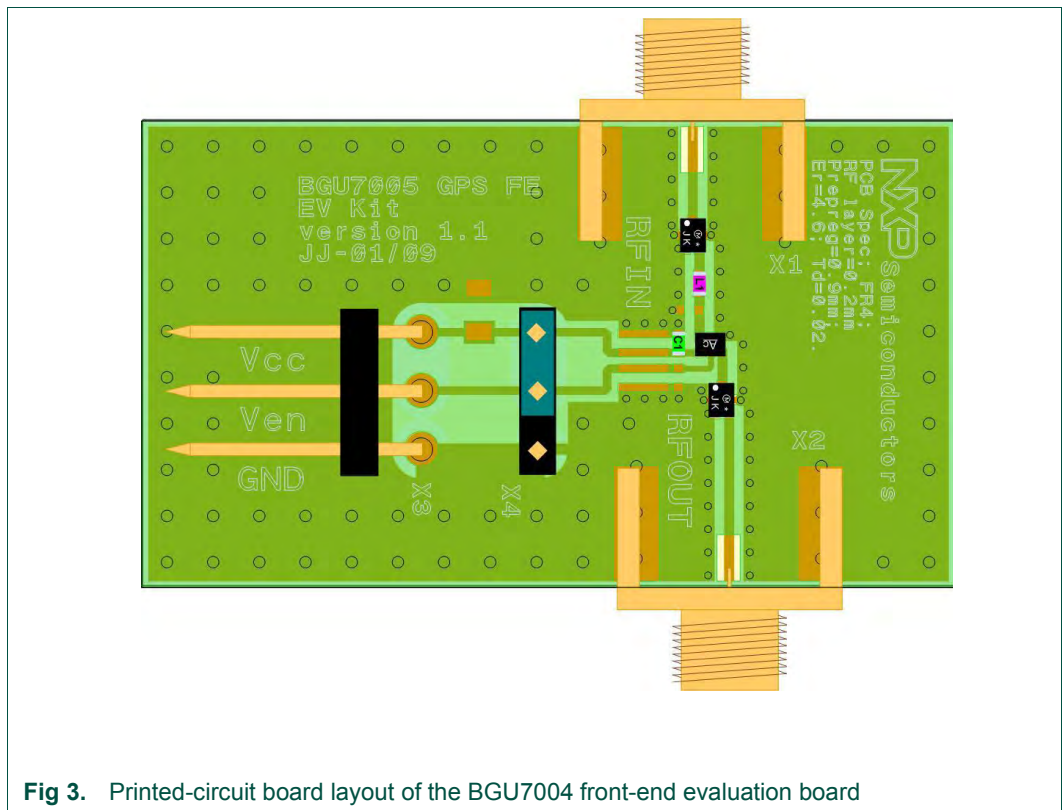
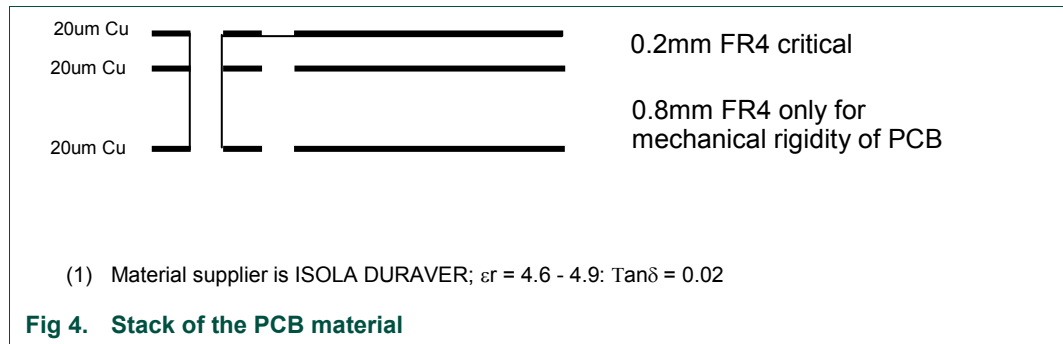

Fig 3. Printed-circuit board layout of the BGU7004 front-end evaluation board

### 3.3 PCB layout

A good PCB layout is an essential part of an RF circuit design. The front-end evaluation board of the BGU7004 can serve as a guideline for laying out a board using the BGU7004. Use controlled impedance lines for all high frequency inputs and outputs. Bypass  $V_{CC}$  with decoupling capacitors, preferably located as close as possible to the device. For long bias lines it may be necessary to add decoupling capacitors along the line further away from the device. Proper grounding of the GND pins is also essential for good RF performance. Either connect the GND pins directly to the ground plane or through vias, or do both, which is recommended. The out-of-band rejection of the SAW filters also depends on the grounding of the filter. The material that has been used for the evaluation board is FR4 using the stack shown in [Fig 4](#).



## 4. Bill of materials

Table 1 BOM of the BGU7004 GPS front-end evaluation board

Designator	Description	Footprint	Value	Supplier Name/type	Comment
<u>Ac</u>	BGU7004	1.45x1mm			LNA MMIC
PCB	v 1.1	35x20mm		BGU7004 GPS FE EV Kit	release 01/09
C1	Capacitor	0402	1nF	Murata GRM1555	Decoupling
L1	Inductor	0402	5.6nH	Murata LQW15A High Q low Rs	Input matching
JK	SAW BPF	1.4x1.1mm		Murata SAFEA1G57KE0F00	Note 1
X1,X2	SMA RF connector	-	-	Johnson, End launch SMA 142-0701-841	RF input/ RF output
X3	DC header	-	-	Molex, PCB header, Right Angle, 1 row, 3 way 90121-0763	Bias connector
X4	JUMPER stage	-	-	Molex, PCB header, Vertical, 1 row, 3 way 90120-0763	Connect Ven to Vcc or separate Ven voltage
JU1	Jumper				

Note 1: Although in this case the Murata SAFEA1G57KE0F00 BPF is used, the performance as given in this document can also be achieved with the use of GPS SAW filters from other. See [paragraph 4.2](#)

## 4.1 BGU7004

NXP Semiconductors' BGU7004 GPS low noise amplifier is designed for the GPS frequency band. The integrated biasing circuit is temperature stabilized, which keeps the current constant over temperature. It also enables the superior linearity performance of the BGU7004. The BGU7004 is also supplied with an enable function that allows it to be controlled via a logic signal. In disabled mode it only consumes less than 1  $\mu$ A.

The output of the BGU7004 is internally matched for 1575.42 MHz whereas only one series inductor at the input is needed to achieve the best RF performance. Both the input and output are AC coupled via an integrated capacitor.

It requires only two external components to build a GPS LNA having the following advantages:

- Low noise;
- High gain;
- High linearity under jamming;
- Very low package height 0.5mm;
- Low current consumption;
- Short power settling time

The BGU7004 data sheet is available and is called, "SiGe:C Low Noise Amplifier MMIC for GPS".

## 4.2 Band pass filters

The band-pass filters that are implemented in the GPS front-end evaluation board are key components regarding the overall system linearity and sensitivity.

Currently there are different suppliers on the market that have SAW filters for the GPS band available. One of the key performance indicators of these filters is having very high rejection at the different cell phone TX frequencies, and simultaneously having low insertion loss in the GPS pass-band. Although the evaluation board is supplied with two Murata SAFA1G57KE0F00 the following alternatives can be considered:

1. EPCOS 9444;
2. Murata SAFA1G57KH0F00;
3. Murata SAFA1G57 KB0F00 low loss variant;
4. Fujitsu FAR-F6KA-1G5754-L4AA;
5. Fujitsu FAR-F6KA-1G5754-L4AJ;

All these filters can use the same footprint. In order to be able to achieve the rejection level as indicated in the data sheet of these filters, it is necessary that the filters are properly grounded. In the layout of the front-end evaluation board the suppliers recommendations have been followed. See [Fig 5](#), please note that every GND pin has its own ground-via and there is a ground path between the input and the output.

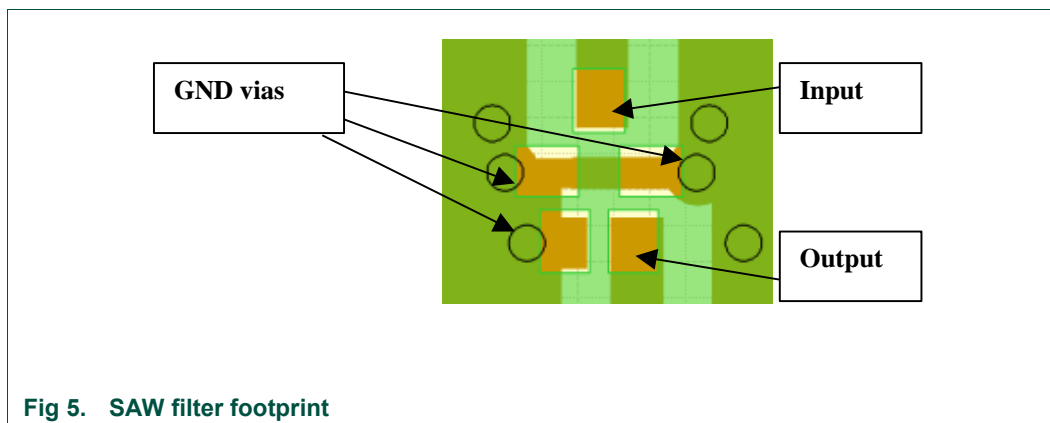

### 4.3 Series inductor

The evaluation board is supplied with Murata LQW15 series inductor of 5.6nH. This is a wire wound type of inductor with high quality factor (Q) and low series resistance ( $R_s$ ). This type of inductor is recommended in order to achieve the best noise performance. High Q inductors from other suppliers can be used. If it is decided to use other low cost inductors with lower Q and higher  $R_s$  the noise performance will degrade.



## 5. Required Equipment

---

In order to measure the evaluation board the following is necessary:

- ✓ DC Power Supply up to 30 mA at 1.5 V to 2.85 V;
- ✓ Two RF signal generators capable of generating an RF signal at the operating frequency of 1575.42 MHz, as well as the jammer frequencies 850 MHz, 1713.42 MHz, 1850 MHz and 1851.42 MHz;
- ✓ An RF spectrum analyzer that covers at least the operating frequency of 1575.42 MHz as well as a few of the harmonics, so up to 6 GHz should be sufficient;
- ✓ “Optional” a version with the capability of measuring noise figure is convenient;
- ✓ Amp meter to measure the supply current (optional);
- ✓ A network analyzer for measuring gain, return loss and reverse Isolation;
- ✓ Noise figure analyzer and noise source;
- ✓ Directional coupler;
- ✓ Proper RF cables.

## 6. Connections and setup

The BGU7004 GPS front-end evaluation board is fully assembled and tested. Please follow the steps below for a step-by-step guide to operate the front-end evaluation board and testing the device functions.

1. Connect the DC power supply to the  $V_{cc}$ , and GND terminals. Set the power supply to the desired supply voltage, between 1.5 V and 2.85 V, but never exceed 3.1 V as it might damage the BGU7004.
2. Jumper JU1 is connected between the  $V_{cc}$  terminal of the evaluation board and the  $V_{en}$  pin of the BGU7004.
3. To evaluate the power on settling time  $t_{on}$  and the power off settling time  $t_{off}$ , it is also possible to use a separate voltage on the  $V_{en}$ ; eventually this voltage can be supplied by a pulse generator. In this case jumper JU1 should be removed. The definition of  $t_{on}$  is the time from 10 % to 90 % of the maximum signal level and for  $t_{off}$  the time from 90 % to 10 % of the maximum signal level.
4. Connect the RF signal generator and the spectrum analyzer to the RF input and the RF output of the evaluation board, respectively. Do not turn on the RF output of the signal generator yet, set it to -40 dBm output power at 1575.42 MHz, set the spectrum analyzer at 1575.42 MHz center frequency and a reference level of 0 dBm. Please note the values of RBW and VBW in the related figures for the exact settings.
5. Turn on the DC power supply and it should read approximately 5mA.
6. Enable the RF output of the generator: The spectrum analyzer displays a tone of around -25 dBm at 1575.42 MHz.
7. Instead of using a signal generator and spectrum analyzer one can also use a network analyzer in order to measure gain as well as in- and output return loss.
8. For noise figure evaluation, either a noise-figure analyzer or a spectrum analyzer with noise option can be used. The use of a 15 dB noise source, like the Agilent 364B is recommended. When measuring the noise figure of the evaluation board, any kind of adaptors, cables etc between the noise source and the evaluation board should be avoided, since this affects the noise performance.
9. For noise under jamming conditions, the following is needed. A 15 dB ENR noise source, a directional coupler, GPS band pass filter, a noise-figure analyzer or a spectrum analyzer with noise option can be used. See [Fig 12](#).

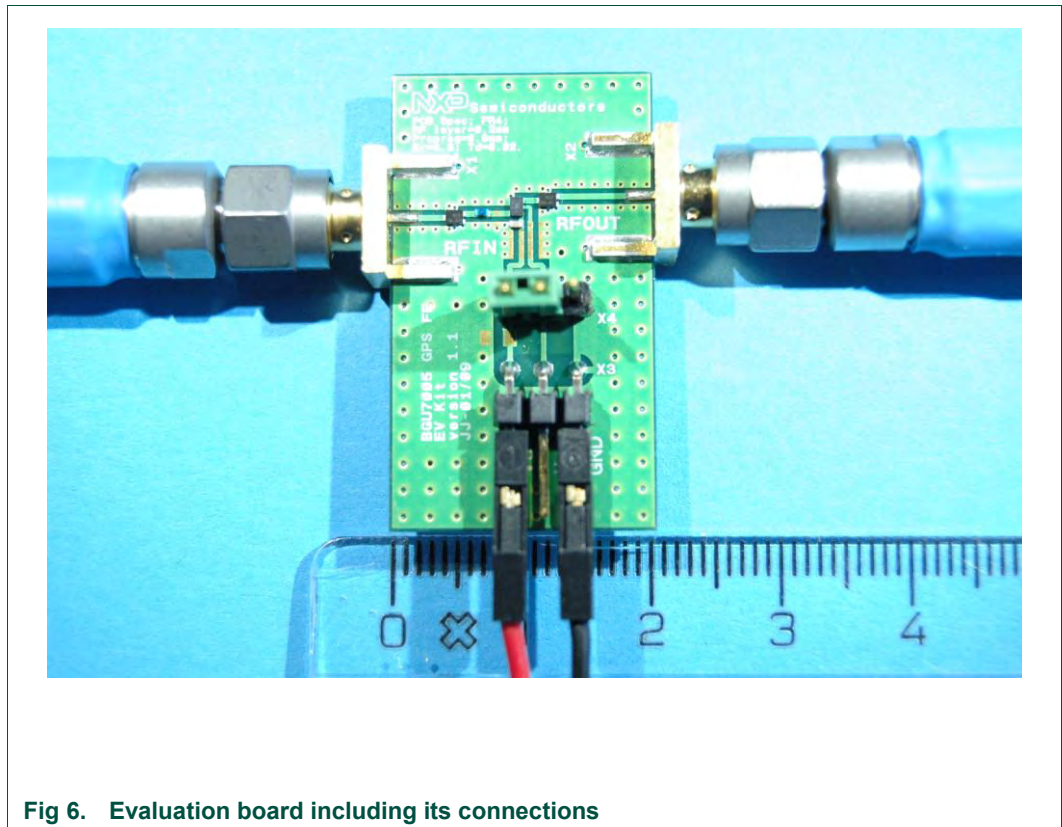

Fig 6. Evaluation board including its connections

## 7. Linearity

At the average power levels of  $-130$  dBm that have to be received by a GPS receiver, the system will not have in-band intermodulation problems caused by the GPS-signal itself. Strong out-of-band cell phone TX jammers however can cause linearity problems, and result in third-order intermodulation products in the GPS frequency band.

### 7.1 Out-of-band input third-order intercept point

This parameter is being measured by a two-tone measurement where the carriers have been chosen as  $L1+138$  MHz and  $L1+276$  MHz. Where  $L1$  is the center of the GPS band,  $1575.42$  MHz. So the two carriers are  $1713.42$  MHz and  $1851.42$  MHz that can be seen as two TX jammers in UMTS FDD and GSM1800 cell phone systems.

One third-order product ( $2f_1-f_2$ ) generated in the LNA due to amplifier third-order nonlinearities can fall at the desired  $1575.42$  MHz frequency as follows:

$$2f_1-f_2=2(1713.42\text{MHz})-1851.42\text{ MHz}=1575.42\text{ MHz}$$

This third-order product can influence the sensitivity of the GPS receiver drastically. So this third-order intermodulation product needs to be as low as possible, meaning the out-of-band intercept point must be as high as possible.

The input power levels of  $f_1$  and  $f_2$  that have been used to measure the IM3 levels on the front-end evaluation board were  $+10$  dBm see [Fig 7](#). [Fig 8](#) shows the IM3 level at the output of the front-end, measured at  $V_{cc} = 1.8$  V.

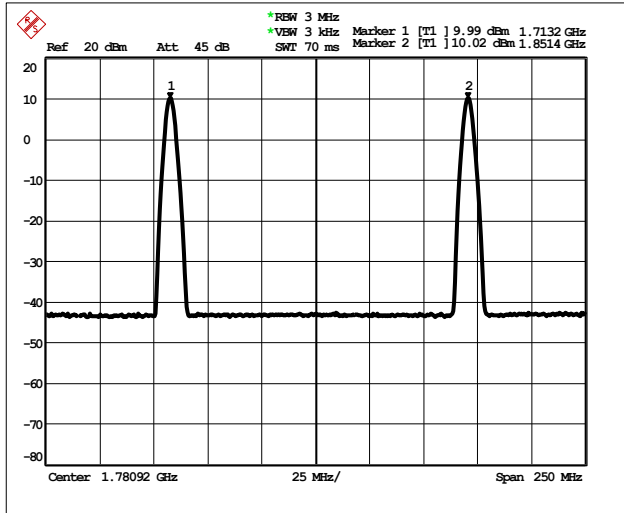

**Fig 7. Input jammers for IM3 measurements L1+138 MHz L1+276 MHz**

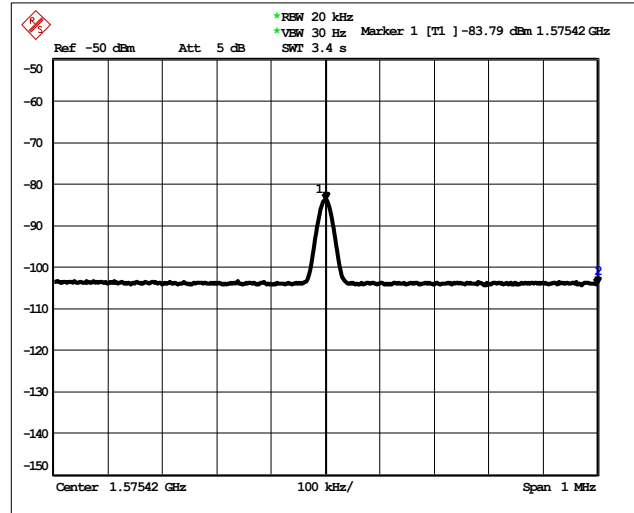

**Fig 8. FE output IM3 level at 1575.42MHz**

With the levels shown in [Fig 7](#) and [Fig 8](#), the out-of-band input third-order intercept point can be calculated

$P_{in}$  of  $f_1$  and  $f_2 = 10$  dBm (see [Fig 7](#))

Left-side output IM3 = -83.8 dBm (1575.42 MHz) (see [Fig 8](#))

Gain of the front-end = 14.6 dB

$$IIM3 = OIM3 - gain = -83.8 dBm - 14.6 dB = -98.4 dBm$$

$$Delta = P_{in}(f1) - IIM3 = 10 - (-98.4) = 108.4 dB$$

$$O_{-IIP3} = P_{in}(f1) + \frac{Delta}{2}$$

$$O - IIP3 = 10 + \frac{108.4}{2} = 64.2 dBm$$

7.2 In-band 1dB gain compression due to 850MHz and 1850MHz jammers

For the measurement described below it is necessary to have clean jammer signals with high RF power in order to measure these parameters on the actual front-end evaluation board. Since these clean signals are hard to generate, these measurements are performed on an BGU7004 GPS Low-noise amplifier evaluation board.(user manual available). With the results of these measurements and the typical rejection levels of the band-pass filters at the jamming frequencies, the values valid for the front-end evaluation board can be calculated.

As already stated before, signal levels in the GPS frequency band of -130dBm average will not cause linearity problems in the GPS band itself. This of course is also valid for the 1dB gain compression in-band. The 1dB compression point at 1575.42MHz caused by cell phone TX jammers however is important.

Measurements have been carried out using the setup shown in Fig 9

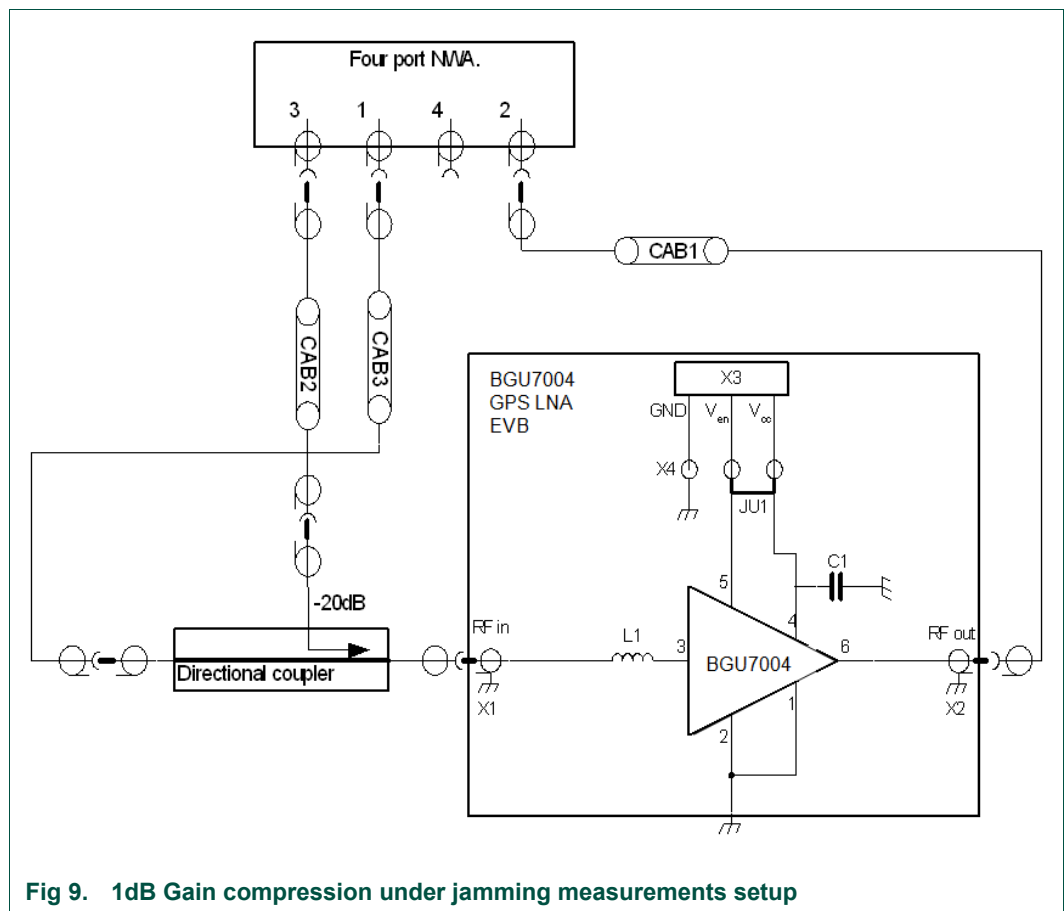

Fig 9. 1dB Gain compression under jamming measurements setup

The gain was measured in the GPS frequency band between port 1 and 2, while simultaneously a jammer power signal was swept on port 3. Please note that the drive power of the jammer is 20 dB lower at the input of the DUT caused by the directional coupler. Fig 10 and Fig 11 show the gain compression curves with 850MHz and 1850MHz jammers respectively.

Calculating the power level at a the front-end gain with 1 dB in compression is done as follows:

The analyzer read out for 850 MHz jammer is +9.3 dBm(see Fig 10) taken into account the 20 dB attenuation of the directional coupler means -10.7dBm. This is for the LNA

Now using the typical rejection at 850MHz of the SAW filter which is 42dB the 1dB compression jammer signal level equals  $-10.7+42=31.3$  dBm.

For 1850 MHz the read out is +14.42 dBm (see Fig 11) taking into account the 20 dB attenuation of the directional coupler means  $-5.58$  dBm. Again this is for the LNA only. Using the typical rejection at 1850MHz of the SAW filter which is 46 dB the 1dB compression jammer signal level equals  $-5.58+46=40.42$ dBm.

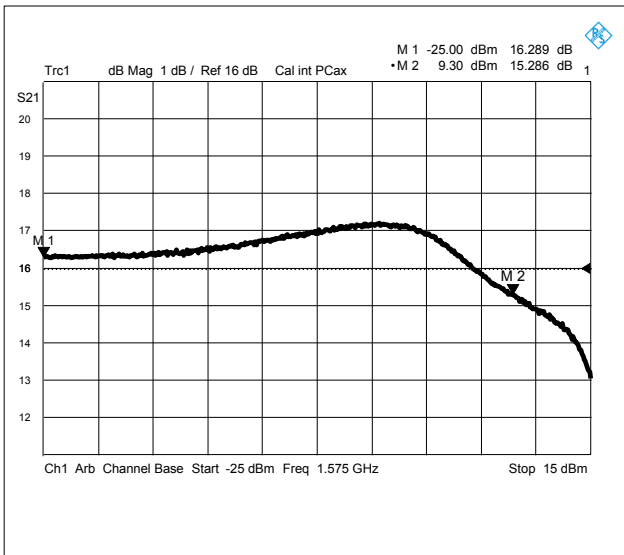

Fig 10. 1dB Gain compression 1.575 GHz 850 Mhz jammer

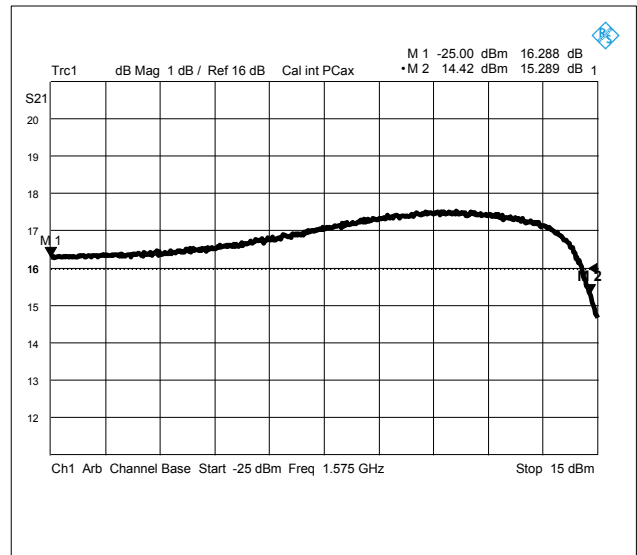

Fig 11. 1dB Gain compression 1.575 GHz 1850 Mhz jammer

## 8. Noise figure as function of jammer power at 850MHz and 1850MHz

For the measurement described below it is necessary to have clean jammer signals with high RF power in order to measure these parameters on the actual front-end evaluation board. Since these clean signals are hard to generate, these measurements are performed on an BGU7004 GPS Low-noise amplifier evaluation board (user manual available). With the results of these measurements and the typical rejection levels of the band-pass filters at the jamming frequencies, the values valid for the front-end evaluation board can be calculated.

Noise figure under jamming conditions is a measure of how the LNA behaves when e.g. a GSM TX interfering signal is at the input of the GPS antenna. To measure this behavior the setup shown in Fig 12 is used.

The jammer signal is coupled via a directional coupler to the DUT: this is to avoid the jammer signal damaging the noise source. The GPS BPF is needed to avoid driving the second-stage LNA in saturation.

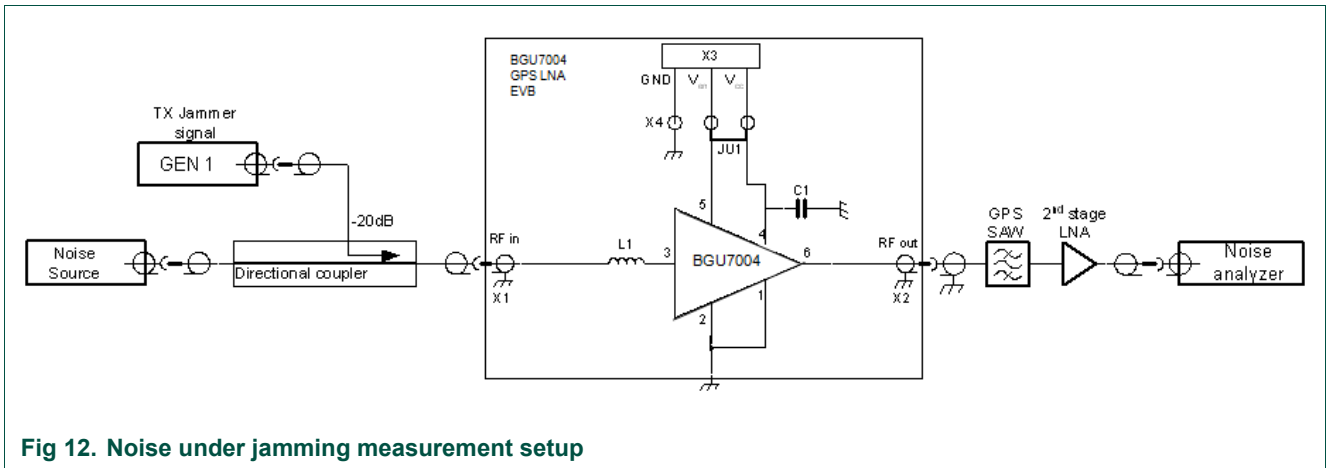

Fig 12. Noise under jamming measurement setup

With the results of these measurements and the specification of the SAW filter, the jammer power levels that cause noise increase can be calculated.

Calculating the power level at which the front-end noise starts to increase is done as follows:

As can be seen in Fig 13 with a 850 MHz jammer the LNA starts increasing the noise at  $P_{jam} = -25$  dBm. For the front-end we have to add the TX rejection of the first BPF. For the filter used these values are 42 dB@ 850 MHz and 47dB @ 1850 MHz. This means the noise of the front-end will start increasing at an 850 MHz jammer level of  $P_{jam} = +17$  dBm. For the 1850 MHz jammer the LNA noise starts to increase also at  $P_{jam} = -25$  dBm, this means for a typical rejection at 1850 MHz of 47dBm, for the used SAW, the front-end noise starts to increase at  $P_{jam} = +22$  dBm, see Fig 14

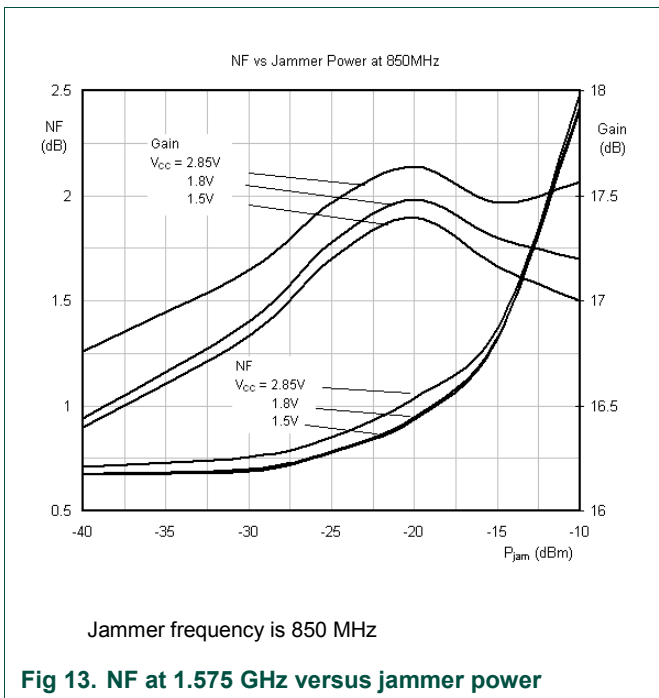

Fig 13. NF at 1.575 GHz versus jammer power

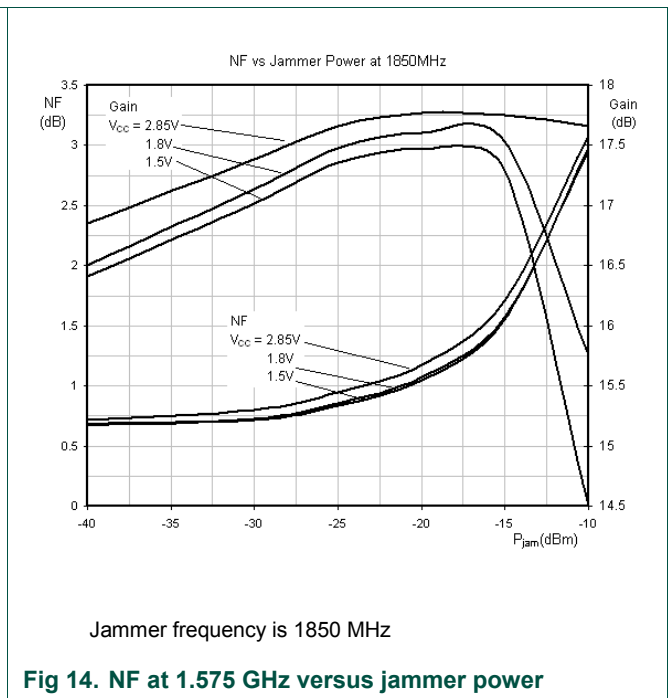
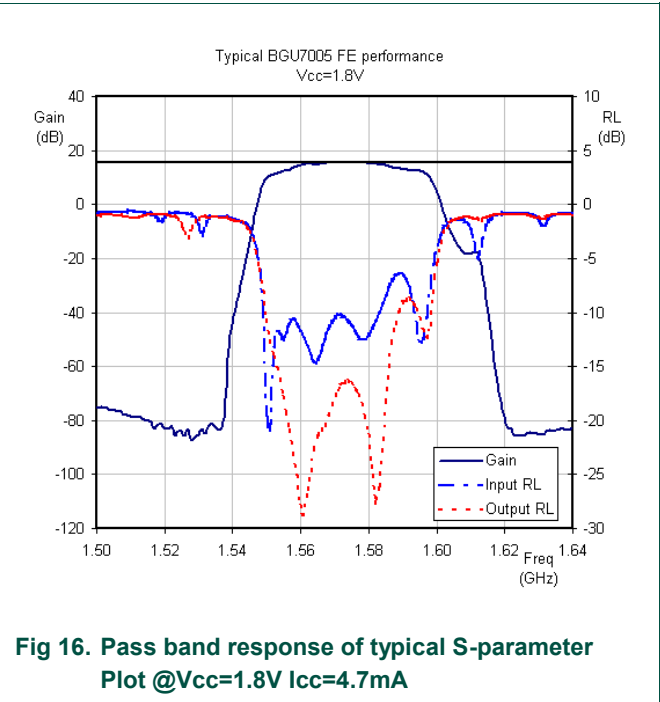
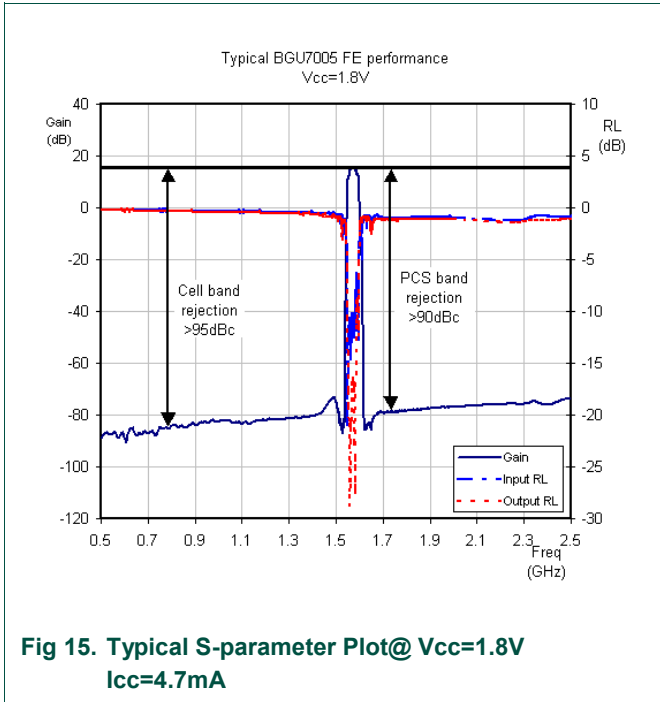

Fig 14. NF at 1.575 GHz versus jammer power

### 9. TX rejection levels

When measuring the front-end evaluation board the input level of the VNA has to be on  $-45$  dBm to avoid activating the adaptive biasing. This low input level results in a very inaccurate measurement result of the TX rejection, which can be seen on the results pages attached to the evaluation boards.

In Fig 15 and Fig 16 one can see the typical TX rejection levels measured more accurate due to segmented power calibration. This is the typical result of 15 EVBs.





## 10. Typical front-end evaluation board results

**Table 2, typical results measured on the evaluation boards.**

Operating Frequency is  $f = 1575.42$  MHz unless otherwise specified; Temp = 25 °C.

Parameter	Symbol	FE EVB	FE EVB	FE EVB	Unit	Remarks
Supply Voltage	$V_{cc}$	1.5	1.8	2.85	V	
Supply Current	$I_{cc}$	4.5	4.6	5.1	mA	
Noise Figure	<sup>[1]</sup> NF	1.78	1.78	1.79	dB	
Power Gain	$G_p$	14.4	14.6	14.9	dB	
Input Return Loss	$RL_{in}$	8.6	8.7	9.3	dB	
Output Return Loss	$RL_{out}$	17.6	18.1	18.4	dB	
Reverse Isolation	$ISO_{rev}$	27.7	24.9	25.4	dB	
Input 1dB Gain Compression	$P_{i1dB}$	-9.4	-8.2	-6.4	dBm	
Input 1dB Gain Compression jammer level at 850MHz	<sup>[2]</sup> $P_{i1dB850MHz}$		31		dBm	
Input 1dB Gain Compression jammer level at 1850MHz	<sup>[2]</sup> $P_{i1dB1850MHz}$		40		dBm	
Cell band rejection, relative to 1575.42MHz @ 850MHz	<sup>[2]</sup> TX rej		>95		dBc	
PCS band rejection relative to 1575.42MHz @ 1850MHz	<sup>[2]</sup> TX rej		>90		dBc	
Input third order intercept point	<sup>[3]</sup> $IP3_i$		+64dB		dBm	
Power settling time	$T_{on}$	1.4	1	0.9	$\mu s$	
	$T_{off}$	1	0.95	0.9		

[1] The noise figures and gain figures are being measured at the SMA connectors of the evaluation board, so the losses of the connectors and the PCB of approximately 0.1dB are not subtracted.

[2] These parameters are mainly determined by the TX rejection levels of the used BPFs, in this case the Murata SAFEA1G57KE0F00, but the performance can also be achieved with the use of GPS SAW filters from other suppliers that are on the market. See [paragraph 4.2](#)

[3] Note3: Jammers at  $f_1=f+138$  MHz and  $f_2=f+276$  MHz, where  $f=1575.42$  MHz.

## 11. Legal information

### 11.1 Definitions

**Draft** — The document is a draft version only. The content is still under internal review and subject to formal approval, which may result in modifications or additions. NXP Semiconductors does not give any representations or warranties as to the accuracy or completeness of information included herein and shall have no liability for the consequences of use of such information.

### 11.2 Disclaimers

**Limited warranty and liability** — Information in this document is believed to be accurate and reliable. However, NXP Semiconductors does not give any representations or warranties, expressed or implied, as to the accuracy or completeness of such information and shall have no liability for the consequences of use of such information.

In no event shall NXP Semiconductors be liable for any indirect, incidental, punitive, special or consequential damages (including - without limitation - lost profits, lost savings, business interruption, costs related to the removal or replacement of any products or rework charges) whether or not such damages are based on tort (including negligence), warranty, breach of contract or any other legal theory.

Notwithstanding any damages that customer might incur for any reason whatsoever, NXP Semiconductors' aggregate and cumulative liability towards customer for the products described herein shall be limited in accordance with the Terms and conditions of commercial sale of NXP Semiconductors.

**Right to make changes** — NXP Semiconductors reserves the right to make changes to information published in this document, including without limitation specifications and product descriptions, at any time and without notice. This document supersedes and replaces all information supplied prior to the publication hereof.

**Suitability for use** — NXP Semiconductors products are not designed, authorized or warranted to be suitable for use in life support, life-critical or safety-critical systems or equipment, nor in applications where failure or malfunction of an NXP Semiconductors product can reasonably be expected to result in personal injury, death or severe property or environmental damage. NXP Semiconductors accepts no liability for inclusion and/or use of NXP Semiconductors products in such equipment or applications and therefore such inclusion and/or use is at the customer's own risk.

**Applications** — Applications that are described herein for any of these products are for illustrative purposes only. NXP Semiconductors makes no representation or warranty that such applications will be suitable for the specified use without further testing or modification.

Customers are responsible for the design and operation of their applications and products using NXP Semiconductors products, and NXP Semiconductors accepts no liability for any assistance with applications or customer product design. It is customer's sole responsibility to determine whether the NXP Semiconductors product is suitable and fit for the customer's applications and products planned, as well as for the planned

application and use of customer's third party customer(s). Customers should provide appropriate design and operating safeguards to minimize the risks associated with their applications and products.

NXP Semiconductors does not accept any liability related to any default, damage, costs or problem which is based on any weakness or default in the customer's applications or products, or the application or use by customer's third party customer(s). Customer is responsible for doing all necessary testing for the customer's applications and products using NXP Semiconductors products in order to avoid a default of the applications and the products or of the application or use by customer's third party customer(s). NXP does not accept any liability in this respect.

**Export control** — This document as well as the item(s) described herein may be subject to export control regulations. Export might require a prior authorization from national authorities.

**Evaluation products** — This product is provided on an "as is" and "with all faults" basis for evaluation purposes only. NXP Semiconductors, its affiliates and their suppliers expressly disclaim all warranties, whether express, implied or statutory, including but not limited to the implied warranties of non-infringement, merchantability and fitness for a particular purpose. The entire risk as to the quality, or arising out of the use or performance, of this product remains with customer.

In no event shall NXP Semiconductors, its affiliates or their suppliers be liable to customer for any special, indirect, consequential, punitive or incidental damages (including without limitation damages for loss of business, business interruption, loss of use, loss of data or information, and the like) arising out of the use of or inability to use the product, whether or not based on tort (including negligence), strict liability, breach of contract, breach of warranty or any other theory, even if advised of the possibility of such damages.

Notwithstanding any damages that customer might incur for any reason whatsoever (including without limitation, all damages referenced above and all direct or general damages), the entire liability of NXP Semiconductors, its affiliates and their suppliers and customer's exclusive remedy for all of the foregoing shall be limited to actual damages incurred by customer based on reasonable reliance up to the greater of the amount actually paid by customer for the product or five dollars (US\$5.00). The foregoing limitations, exclusions and disclaimers shall apply to the maximum extent permitted by applicable law, even if any remedy fails of its essential purpose.

### 11.3 Trademarks

Notice: All referenced brands, product names, service names and trademarks are property of their respective owners.

## 12. Contents

---

<b>1.</b>	<b>Introduction .....</b>	<b>3</b>
<b>2.</b>	<b>General description.....</b>	<b>4</b>
<b>3.</b>	<b>BGU7004 GPS front-end evaluation board.....</b>	<b>4</b>
3.1	Application Circuit.....	4
3.2	Board Layout.....	5
3.3	PCB layout .....	6
<b>4.</b>	<b>Bill of materials.....</b>	<b>6</b>
4.1	BGU7004.....	7
4.2	Band pass filters.....	7
4.3	Series inductor .....	8
<b>5.</b>	<b>Required Equipment .....</b>	<b>9</b>
<b>6.</b>	<b>Connections and setup.....</b>	<b>10</b>
<b>7.</b>	<b>Linearity .....</b>	<b>11</b>
7.1	Out-of-band input third-order intercept point .....	11
7.2	In-band 1dB gain compression due to 850MHz and 1850MHz jammers .....	13
<b>8.</b>	<b>Noise figure as function of jammer power at 850MHz and 1850MHz .....</b>	<b>14</b>
<b>9.</b>	<b>TX rejection levels.....</b>	<b>16</b>
<b>10.</b>	<b>Typical front-end evaluation board results .....</b>	<b>17</b>
<b>11.</b>	<b>Legal information .....</b>	<b>18</b>
11.1	Definitions.....	18
11.2	Disclaimers.....	18
11.3	Trademarks .....	18
<b>12.</b>	<b>Contents.....</b>	<b>19</b>

---

Please be aware that important notices concerning this document and the product(s) described herein, have been included in the section 'Legal information'.

---

© NXP B.V. 2011. All rights reserved.

For more information, please visit: <http://www.nxp.com>  
For sales office addresses, email to: [salesaddresses@nxp.com](mailto:salesaddresses@nxp.com)

Date of release: 14 June 2011  
Document identifier: UM10490