

Programmable Digital Controller E5AR-T

CSM_E5AR-T_DS_E_3_4

A new High-speed, High-precision Digital Controller that is Programmable!

- Create up to 32 programs with up to 256 segments total.
- Coordinated operation for up to four channels with one Digital Controller.
- 0.01°C High resolution for Pt input.
- High-speed sampling at 50 ms.
- Settings easily made from a computer using the CX-Thermo.
- RoHS compliance for world-wide application.



Refer to *Safety Precautions for All E5□R Models.*

For the most recent information on models that have been certified for safety standards, refer to your OMRON website.

Model Number Structure

■ Model Number Legend

Note: When your order, specify the power supply voltage.

E5AR-T□□□□□□□□-□□□□
1 2 3 4 5 6 7 8 9

1. Control method

Blank: Standard or heating/cooling control
P: Position proportional control

2. Output 1

R: NO relay output + NO relay output
Q: Pulse output/current output + pulse output
C: Current output + current output

3. Output 2

R: NO relay output + NO relay output
Q: Pulse output/current output + pulse output
C: Current output + current output

4. Auxiliary Outputs

Blank: None
4: NO relay output + NO relay output
E: 5 transistor outputs + 5 transistor outputs

5. Communications

Blank: None
3: RS-485 communications

6. Optional function

Blank: None
D: 4 event inputs
M: 4 event inputs + 4 event inputs

7. Input 1

B: Universal-input and 2 event inputs
F: Universal-input and FB
W: Universal-input and universal-input

8. Input 2

Blank: None
W: Universal-input and universal-input

9. Other

FLK: CompoWay/F communications

Note: The above model number legend is intended as a functional description of models. Not all possible combinations of functions are available. Confirm model availability in *Ordering Information* when ordering.

Note: Be sure to read the precautions for correct use and other precautions in the following user's manual before using the Digital Controller.
E5AR/ER Digital Controller User's Manual (Cat. No. Z182)

Ordering Information

■ Digital Controllers

When your order, specify the power supply voltage.

Programmable Digital Controllers (100 to 240 VAC)

Size	Control type	Control mode	Outputs (control/transfer)	Optional functions			Model
				Auxiliary outputs (SUB)	Event inputs	Serial communi- cations	
96 × 96 mm	Basic control (1 loop)	Standard control Heating and cooling control	2 (pulse + pulse/current)	4	2	None	E5AR-TQ4B
			2 (current + current)				E5AR-TC4B
			2 (pulse + pulse/current)				RS-485
			2 (current + current)	E5AR-TC43B-FLK			
			2 (pulse + pulse/current)	10 (See note 1.)	10	E5AR-TQE3MB-FLK	
			2 (current + current)			E5AR-TCE3MB-FLK	
	2-loop control	2-loop standard control Single-loop heating and cooling control Single-loop cascade control Single-loop control with remote SP Single-loop proportional control	2 (pulse + pulse/current)	4	4	RS-485	E5AR-TQ43DW-FLK
			2 (current + current)				E5AR-TC43DW-FLK
			4 (2 pulse + pulse/2 current)	10 (See note 1.)	8	E5AR-TQQE3MW- FLK	
	4-loop control	4-loop standard control 2-loop heating and cooling control (See note 2.)	4 (4 current)	10 (See note 1.)	8	RS-485	E5AR-TCCE3MWW- FLK
			4 (2 pulse + pulse/2 current)				E5AR-TQQE3MWW- FLK
	Control valve control (1 loop)	Single-loop position-proportional control	Relay outputs (1 open, 1 closed)	4	4	None	E5AR-TPR4DF
			Relay outputs (1 open, 1 closed) and 1 current	10 (See note 1.)	8	RS-485	E5AR-TPRQE3MF- FLK

Note 1: The outputs are transistor output.

2: Only for coordinated operation. (A separate program cannot be set for each channel.)

Programmable Digital Controllers (24 VAC/DC)

Size	Control type	Control mode	Outputs (control/transfer)	Optional functions			Model
				Auxiliary outputs (SUB)	Event inputs	Serial communi- cations	
96 × 96 mm	Basic control (1 loop)	Standard control Heating and cooling control	2 (pulse + pulse/current)	4	2	None	E5AR-TQ4B
			2 (current + current)				E5AR-TC4B
			4 (pulse + pulse/current + 2 current)	10 (See note 1.)	10	RS-485	E5AR-TQCE3MB-FLK
	2-loop control	2-loop standard control Single-loop heating and cooling control Single-loop cascade control Single-loop control with remote SP Single-loop proportional control	4 (2 pulse + pulse/2 current)	10 (See note 1.)	8	RS-485	E5AR-TQQE3MW- FLK
	4-loop control	4-loop standard control 2-loop heating and cooling control (See note 2.)	4 (4 current)	10 (See note 1.)	8	RS-485	E5AR-TCCE3MWW- FLK
	Control valve control (1 loop)	Single-loop position-proportional control	Relay outputs (1 open, 1 closed)	4	4	None	E5AR-TPR4DF
Relay outputs (1 open, 1 closed) and 1 current			10 (See note 1.)	8	RS-485	E5AR-TPRQE3MF- FLK	

Note 1: The outputs are transistor output.

2: Only for coordinated operation. (A separate program cannot be set for each channel.)

Inspection Results

If an inspection report is required, it can be ordered at the same time as the Digital Controller using the following model number.

Inspection Report (Order Separately)

Model
E5AR-K

■ Accessories (Order Separately)

Terminal Cover

Descriptions	Model
Terminal Cover for E5AR	E53-COV14

Unit Label Sheet

Model
Y92S-L1

Rubber Packing

Model
Y92S-P4

Note: The Rubber Packing is provided with the Digital Controller.

Mounting Adapters

Model
Y92H-9

Note: These Mounting Adapters are provided with the Digital Controller.

Specifications



■ Ratings

Supply voltage (See note 2.)	CE marking	100 to 240 VAC, 50/60 Hz	24 VAC, 50/60 Hz; 24 VDC
	UL certification	100 to 120 VAC, 50/60 Hz	
Operating voltage range		85% to 110% of rated supply voltage	
Power consumption		22 VA max. (with maximum load)	15 VA/10 W max. (with maximum load)
Sensor input (See note 3.)		Thermocouple: K, J, T, E, L, U, N, R, S, B, W Platinum resistance thermometer: Pt100 Current input: 4 to 20 mA DC, 0 to 20 mA DC (including remote SP input) Voltage input: 1 to 5 VDC, 0 to 5 VDC, 0 to 10 VDC (including remote SP input) (Input impedance: 150 Ω for current input, approx. 1 MΩ for voltage input)	
Control output	Voltage (pulse) output	12 VDC, 40 mA max. with short-circuit protection circuit (E5AR-TQQE3MW-FLK: 21 mA max.)	
	Current output	0 to 20 mA DC, 4 to 20 mA DC; load: 500 Ω max. (including transfer output) (Resolution: Approx. 54,000 for 0 to 20 mA DC; Approx. 43,000 for 4 to 20 mA DC)	
	Relay output	Position-proportional control type (open, closed) N.O., 250 VAC, 1 A (including inrush current)	
Auxiliary output		Relay Output N.O., 250 VAC, 1 A (resistive load) Transistor Output Maximum load voltage: 30 VDC; Maximum load current: 50 mA; Residual voltage: 1.5 V max.; Leakage current: 0.4 mA max.	
Potentiometer input		100 Ω to 2.5 kΩ	
Event input	Contact	Input ON: 1 kΩ max.; OFF: 100 kΩ min.	
	No-contact	Input ON: Residual voltage of 1.5 V max.; OFF: Leakage current of 0.1 mA max. Short-circuit: Approx. 4 mA	
Remote SP input		Refer to the information on sensor input.	
Transfer output		Refer to the information on control output.	
Control method		2-PID or ON/OFF control	
Setting method		Digital setting using front panel keys or setting using serial communications	
Indication method		7-segment digital display and single-lighting indicator Character Height PV display: 12.8 mm; SV display: 7.7 mm; MV display: 7.7 mm	
Other functions		Depends on model.	
Ambient operating temperature		-10 to 55°C (with no icing or condensation) For 3 years of assured use: -10 to 50°C (with no icing or condensation)	
Ambient operating humidity		25% to 85%	
Storage temperature		-25 to 65°C (with no icing or condensation)	

- Note 1:** Do not use an inverter output as the power supply. (Refer to *Safety Precautions for All E5[R] Models.*)
Note 2: The supply voltage (i.e., 100 to 240 VAC or 24 VAC/VDC) depends on the model. Be sure to specify the required type when ordering.
Note 3: The Controller is equipped with multiple sensor input. Temperature input or analog input can be selected with the input type setting switch. There is basic insulation between power supply and input terminals, power supply and output terminals, and input and output terminals.

■ Input Ranges

Platinum Resistance Thermometer, Thermocouple, Current, or Voltage Input

Input type	Platinum resistance thermometer	Thermocouple														Current		Voltage		
		Pt100	K	J	T	E	L	U	N	R	S	B	W (W/Re 5-26)	mA	V					
Temperature range (°C)		850.0	1300.0	850.0	400.0	400.0	600.0	850.0	400.0	1300.0	1700.0	1700.0	1800.0	2300.0	20 to 4	20 to 0	5 to 1	5 to 0	10 to 0	
		-200.0	-150.0	-200.0	-20.0	-100.0	-20.0	0.0	-100.0	-200.0	-200.0	0.0	0.0	100.0	0.0	0.0	0.0	0.0	0.0	0.0
Setting	0	1	2	3	4	5	6	7	8	9	10	11	12	13	14	15	16	17	18	19
Minimum setting unit (SP and alarm)	0.1°C	0.01°C	0.1°C														(Depends on scaling and number of decimal places.)			
Input type setting switch	Set to TC.PT. 														Set to ANALOG 					

Note: The shaded area indicates the setting status at the time of purchase.

■ Characteristics

Indication accuracy	Thermocouple input with cold junction compensation: ($\pm 0.1\%$ of PV or $\pm 1^\circ\text{C}$, whichever is greater) ± 1 digit max. (See note 1.) Thermocouple input without cold junction compensation: ($\pm 0.1\%$ FS or $\pm 1^\circ\text{C}$, whichever is smaller) ± 1 digit (See note 2.) Analog input: $\pm 0.1\%$ FS ± 1 digit max. Platinum resistance thermometer input: ($\pm 0.1\%$ of PV or $\pm 0.5^\circ\text{C}$, whichever is greater) ± 1 digit max. Position-proportional potentiometer input: $\pm 5\%$ FS ± 1 digit max.
Control mode	Standard control (heating or cooling control), heating/cooling control, standard control with remote SP (2-input models only), heating/cooling control with remote SP (2-input models only), cascade standard control (2-input models only), cascade heating/cooling control (2-input models only), proportional control (2-input models only), position-proportional control (control-valve control models only)
Influence of temperature	Thermocouple input (R, S, B, W): ($\pm 1\%$ of PV or $\pm 10^\circ\text{C}$, whichever is greater) ± 1 digit max. Other thermocouple input: ($\pm 1\%$ of PV or $\pm 4^\circ\text{C}$, whichever is greater) ± 1 digit max. *K thermocouple at -100°C max.: $\pm 10^\circ\text{C}$ max.
Influence of voltage	
Influence of EMS. (at EN61326-1)	Platinum resistance thermometer: ($\pm 1\%$ of PV or $\pm 2^\circ\text{C}$, whichever is greater) ± 1 digit max. Analog input: ($\pm 1\%$ FS) ± 1 digit max.
Control period	0.2 to 99.0 s (in units of 0.1 s) for time-proportioning control output
Proportional band (P)	0.00% to 999.99% FS (in units of 0.01% FS)
Integral time (I)	0.0 to 3,999.9 s (in units of 0.1 s)
Derivative time (D)	0.0 to 3,999.9 s (in units of 0.1 s)
Hysteresis	0.01% to 99.99% FS (in units of 0.01% FS)
Manual reset value	0.0% to 100.0% (in units of 0.1% FS)
Alarm setting range	-19,999 to 99,999 EU (See note 3.) (The decimal point position depends on the input type and the decimal point position setting.)
Input sampling period	50 ms
Insulation resistance	20 M Ω min. (at 500 VDC)
Dielectric strength	2,000 VAC, 50/60 Hz for 1 min (between charged terminals of different polarities)
Vibration resistance (malfunction)	10 to 55 Hz, 20 m/s ² for 10 min each in X, Y, and Z directions
Shock resistance (malfunction)	100 m/s ² , 3 times each in X, Y, and Z directions
Inrush current	100 to 240-VAC models: 50 A max. 24 VAC/VDC models: 30 A max.
Weight	Controller only: Approx. 450 g; Mounting bracket: Approx. 60 g; Terminal cover: Approx. 30 g
Degree of protection	Front panel: NEMA4X for indoor use; Rear case: IP20; Terminals: IP00
Memory protection	Non-volatile memory (number of writes: 100,000)
Applicable standards	UL 61010C-1, CSA C22.2 No. 1010-1 (Power supply voltage: 100 to 120 VAC): Pollution degree 2/Overvoltage category 2 EN 61010-1 (IEC 61010-1) (Power supply voltage: 100 to 240 VAC): Pollution degree 2/Overvoltage category 2
EMC	EMI: EN61326-1 (See note 4.) Radiated Interference Electromagnetic Field Strength: EN55011 Group 1 Class A Noise Terminal Voltage: EN55011 Group 1 Class A EMS: EN61326-1 (See note 4.) ESD Immunity: EN61000-4-2: 4 kV contact discharge (level 2) 8 kV air discharge (level 3) Electromagnetic Immunity: EN61000-4-3: 10 V/m (amplitude-modulated, 80 MHz to 1 GHz, 1.4 GHz to 2 GHz) (level 3) Burst Noise Immunity: EN61000-4-3: EN61000-4-4: 2 kV power line (level 3) 2 kV output line (relay output) (level 4) 1 kV measurement line, I/O signal line (level 4) 1 kV communications line (level 3) Conducted Disturbance Immunity: EN61000-4-6: 3 V (0.15 to 80 MHz) (level 3) Surge Immunity: EN61000-4-5: 1 kV line to line (power line, output line (relay output)) (level 2) 2 kV line to ground (power line, output line (relay output)) (level 3) Power Frequency Magnetic Field Immunity: EN61000-4-8: 30 A/m (50 Hz) continuous field Voltage Dip/Interrupting Immunity: EN61000-4-11: 0.5 cycle, 100% (rated voltage)

Note 1: K-, T-, or N-type thermocouple at -100°C max.: $\pm 2^\circ\text{C}$ ± 1 digit max.

U- or L-type thermocouple: $\pm 2^\circ\text{C}$ ± 1 digit max.

B-type thermocouple at 400°C max.: No accuracy specification.

R- or S-type thermocouple at 200°C max.: $\pm 3^\circ\text{C}$ ± 1 digit max.

W-type thermocouple: ($\pm 0.3\%$ of PV or $\pm 3^\circ\text{C}$, whichever is greater) ± 1 digit max.

2: U- or L-type thermocouple: $\pm 1^\circ\text{C}$ ± 1 digit

R- or S-type thermocouple at 200°C max.: $\pm 1.5^\circ\text{C}$ ± 1 digit

3: "EU" (Engineering Unit) represents the unit after scaling. If a temperature sensor is used, it is either $^\circ\text{C}$ or $^\circ\text{F}$.

4: Industrial electromagnetic environment (EN/IEC 61326-1 Table 2)

■ Communications Specifications

Transmission path connection	Multiple points
Communications method	RS-485 (two-wire, half duplex)
Synchronization method	Start-stop synchronization
Baud rate	9,600, 19,200, or 38,400 bps
Transmission code	ASCII
Data bit length	7 or 8 bits
Stop bit length	1 or 2 bits
Error detection	Vertical parity (none, even, odd) Block check character (BCC): CompoWay/F CRC-16: Modbus
Flow control	None
Interface	RS-485
Retry function	None
Communications buffer	217 bytes
Communications response send wait time	0 to 99 ms, Default: 20 ms

■ Program Control Functions

Number of programs (patterns)	32 (with 8 segments/program)
Number of segments (steps)	32 (with 8 programs)
Maximum number of segments	256
Segment setting method	Time setting (Segment set with set point and time.) Gradient setting (Segment set with set point, gradient, and time.)
Segment times	0 h 0 min to 99 h 59 min 0 min 0 s to 99 min 59 s 0 min 00.0 s to 99 min 59.9 s
Alarm group number specifications	Number of groups: 4 Setting method: Set separately for each program.
Reset operation	Select either stopping control or fixed SP operation.
Startup operation	Select continuing, resetting, manual operation, run mode, or ramp back operation.
PID sets	Number of sets: 8 Setting method: Set separately for each program (automatic PID group selection also supported).
Alarm SP function	Select from ramp SP and target SP.
Program status control	Segment operation: Advance, hold, and back Program operation: Program repetitions and program links
Wait operation	Wait method: Select from waiting at segment ends and always waiting. Wait width setting: Wait width upper limit and lower limit set separately for each program. Setting method: ON/OFF setting for each segment
Time signals	Number of outputs: 6 Number of ON/OFF operations: 3 each per output Setting method: Set separately for each program.
Segment outputs	Number of outputs: 10 Setting method: ON/OFF set for each segment.
Program status output	Program end output (pulse width can be set) Segment number output
Program startup operation	PV start: Select from segment 1 set point, slope-priority PV start, and time-priority PV start. Standby: Standby
Operation end operation	Select from resetting, continuing control at final set point, and fixed SP control.
Number of event inputs	10 max.

Wiring Terminals

E5AR-T (Programmable Type)

E5AR-TQ4B

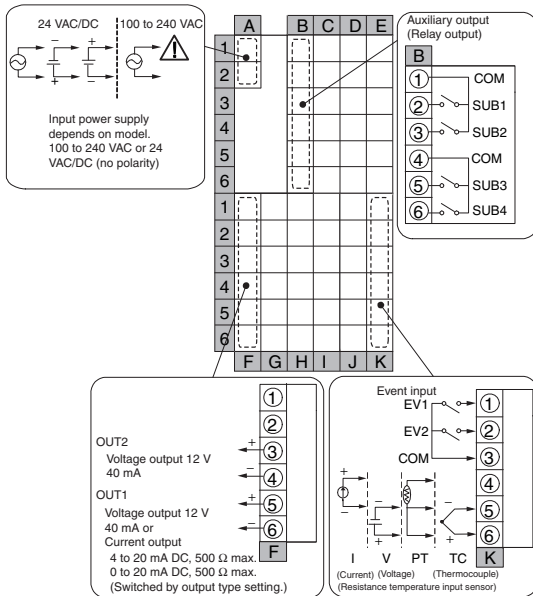

E5AR-TC4B

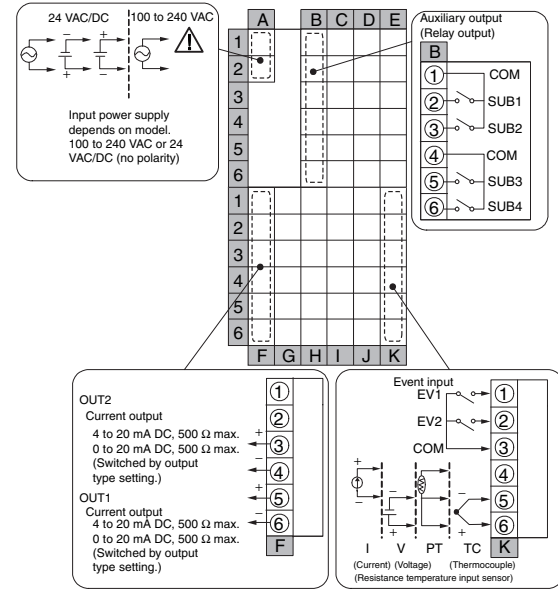

E5AR-TQ43B-FLK

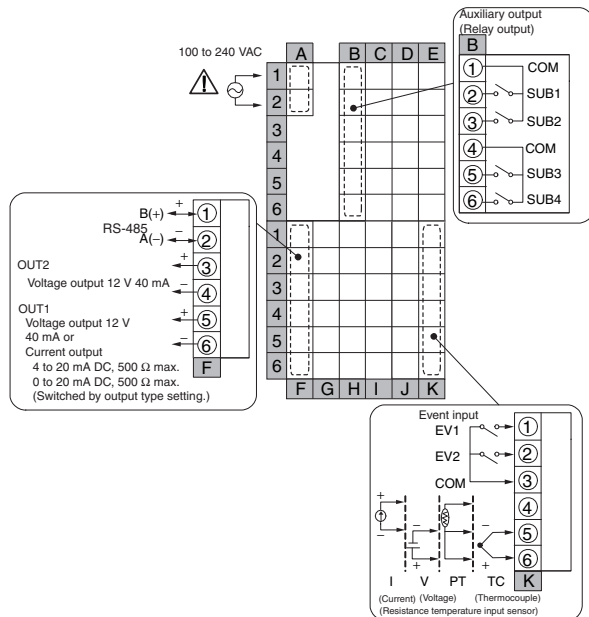

E5AR-TC43B-FLK

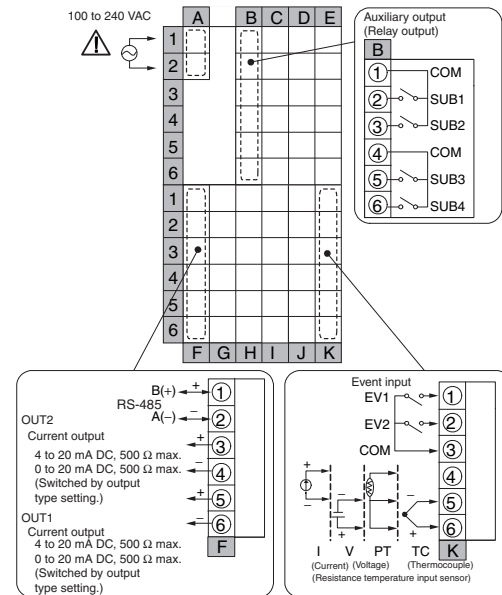

Note The power supply voltage must be 100 to 240 VAC or 24 VAC/DC for the E5AR-T to comply with CE marking requirements.
The power supply voltage must be 100 to 120 VAC or 24 VAC/DC for the E5AR-T to comply with UL requirements.

E5AR-TQE3MB-FLK

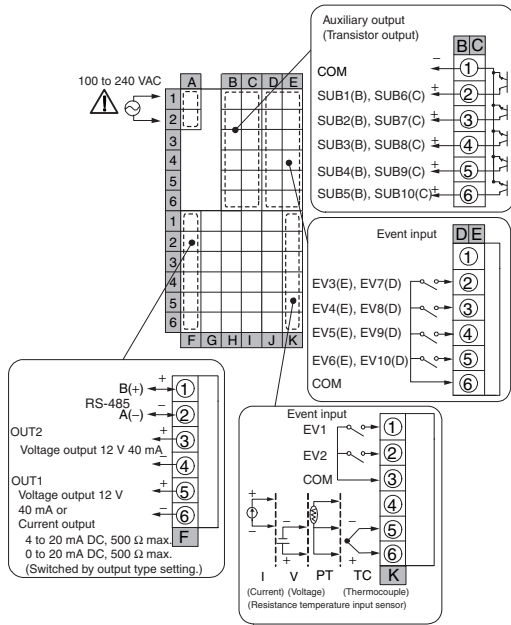

E5AR-TCE3MB-FLK

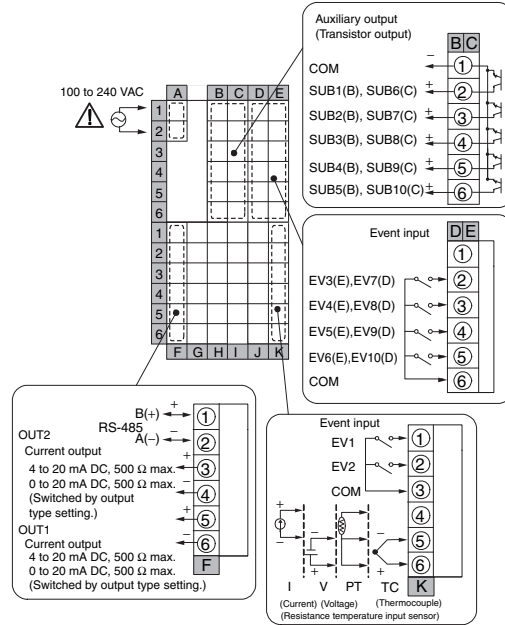

E5AR-TQCE3MB-FLK

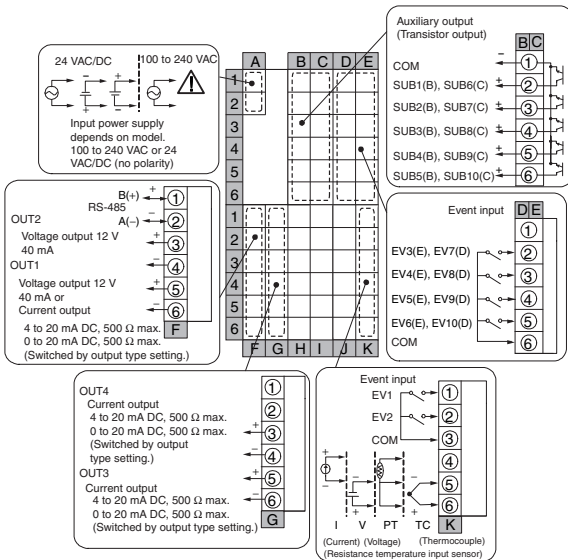

Note

The power supply voltage must be 100 to 240 VAC or 24 VAC/DC for the E5AR-T to comply with CE marking requirements.

The power supply voltage must be 100 to 120 VAC or 24 VAC/DC for the E5AR-T to comply with UL requirements.

E5AR-TQ43DW-FLK (2-loop Control)

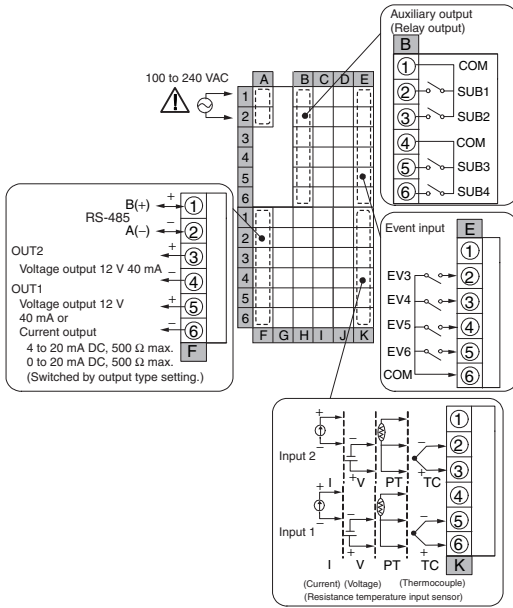

E5AR-TC43DW-FLK (2-loop Control)

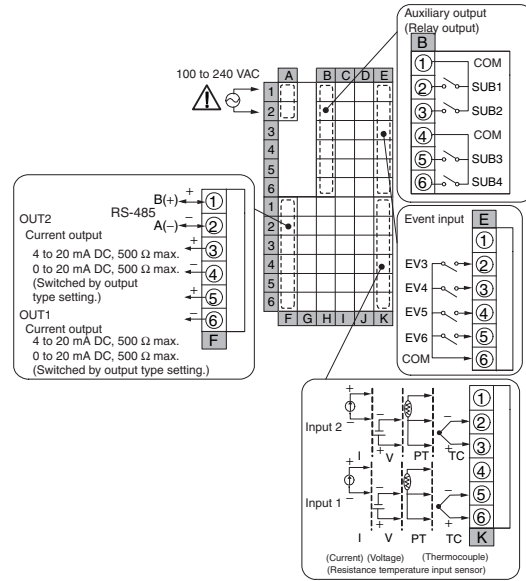

E5AR-TQQE3MW-FLK (2-loop Control)

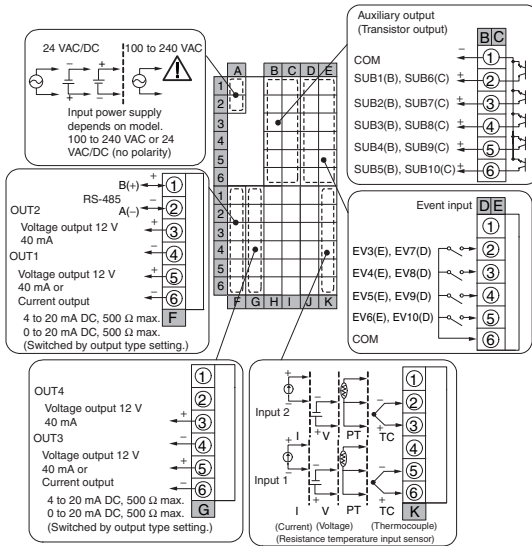

Note

The power supply voltage must be 100 to 240 VAC or 24 VAC/DC for the E5AR-T to comply with CE marking requirements.
 The power supply voltage must be 100 to 120 VAC or 24 VAC/DC for the E5AR-T to comply with UL requirements.

E5AR-TCCE3MWW-FLK (4-loop Control)

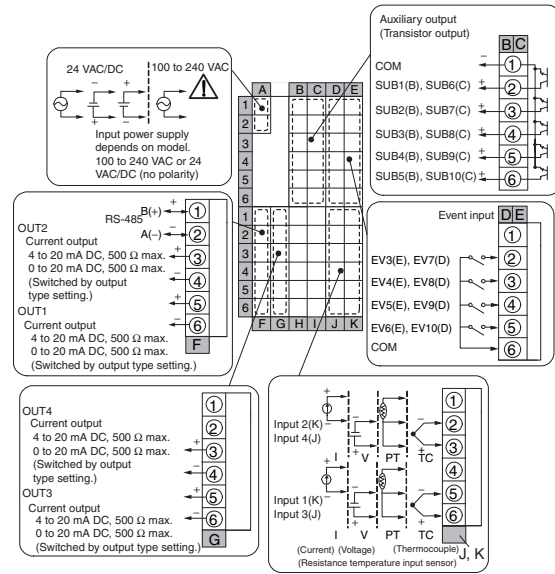

E5AR-TQQE3MWW-FLK (4-loop Control)

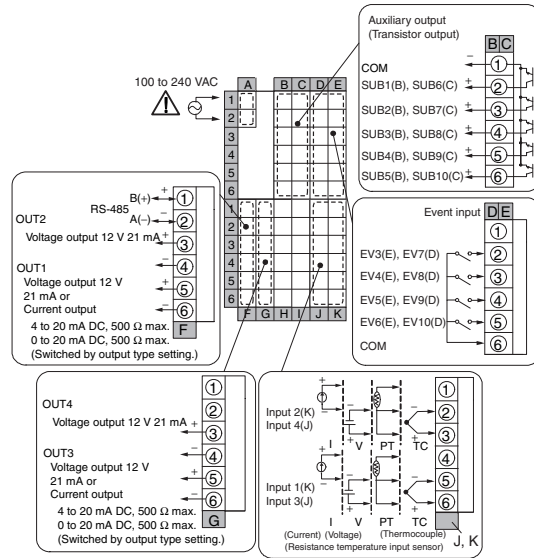

E5AR-TPR4DF

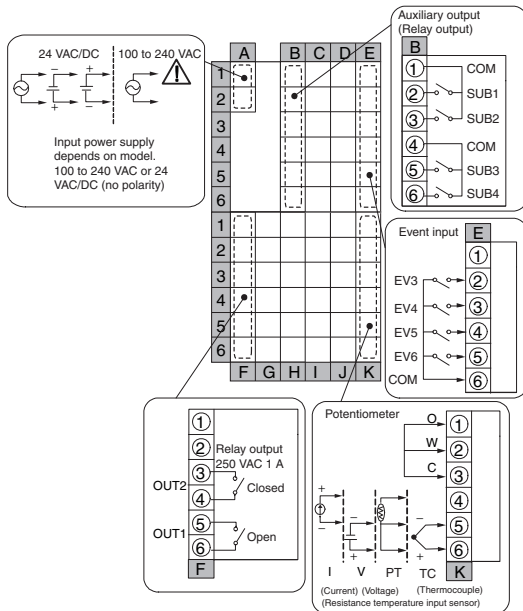

E5AR-TPRQE3MF-FLK

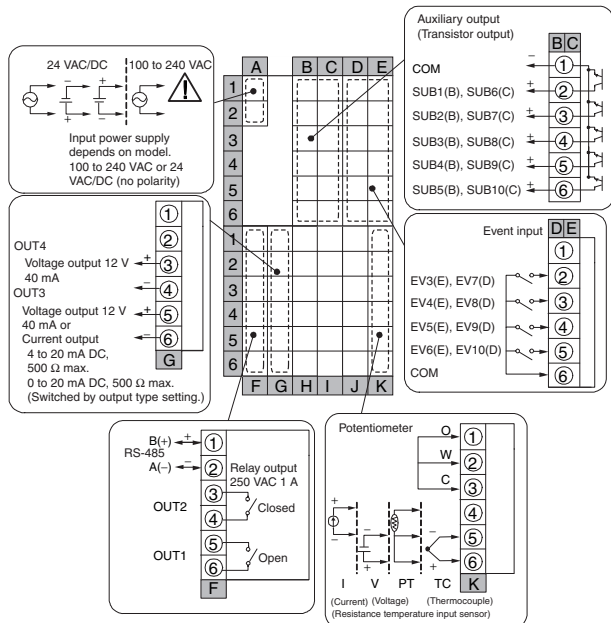

Note

The power supply voltage must be 100 to 240 VAC or 24 VAC/DC for the E5AR-T to comply with CE marking requirements.
 The power supply voltage must be 100 to 120 VAC or 24 VAC/DC for the E5AR-T to comply with UL requirements.

Nomenclature

E5AR-T

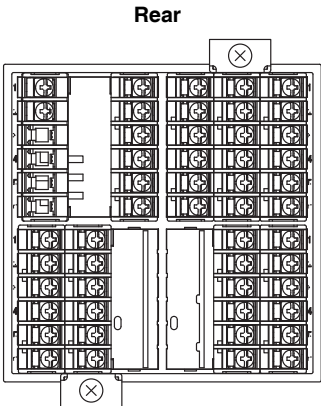
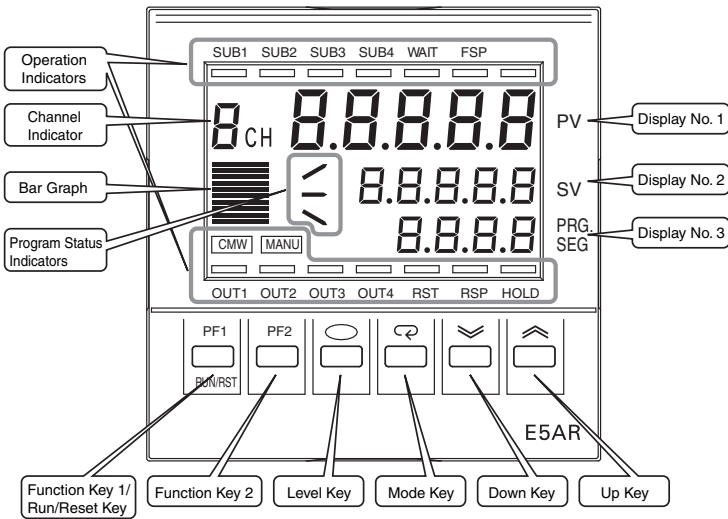

Dimensions

Note: All units are in millimeters unless otherwise indicated.

E5AR-T

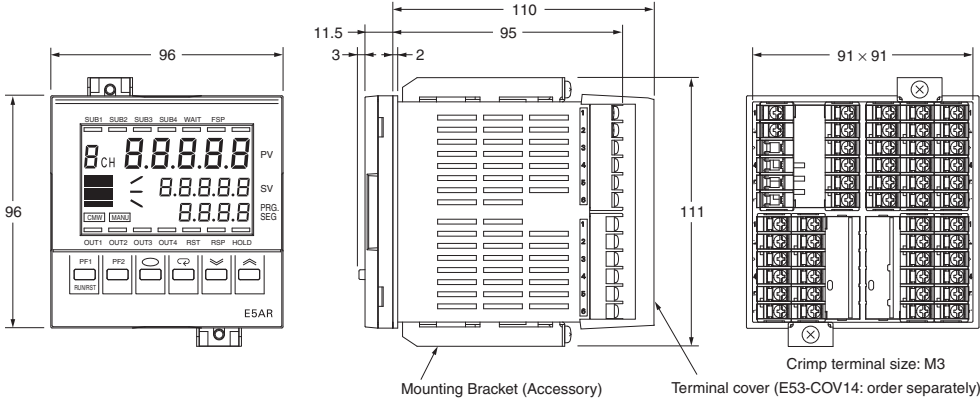
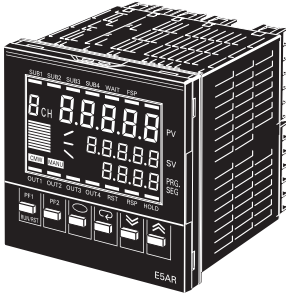

Panel Cutouts

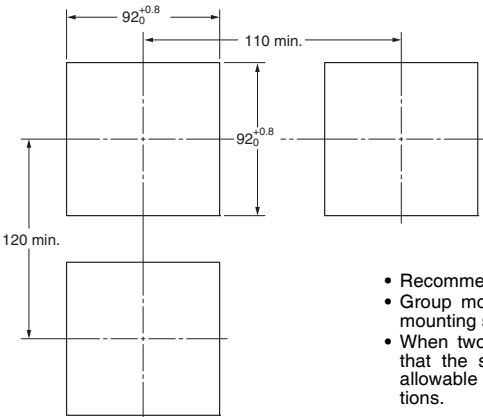

- Recommended panel thickness is 1 to 8 mm.
- Group mounting is not possible. (Maintain the specified mounting space between Controllers.)
- When two or more Controllers are mounted, make sure that the surrounding temperature does not exceed the allowable operating temperature specified in the specifications.

■ Accessories (Order Separately)

Terminal Cover

E53-COV14 (for E5AR)

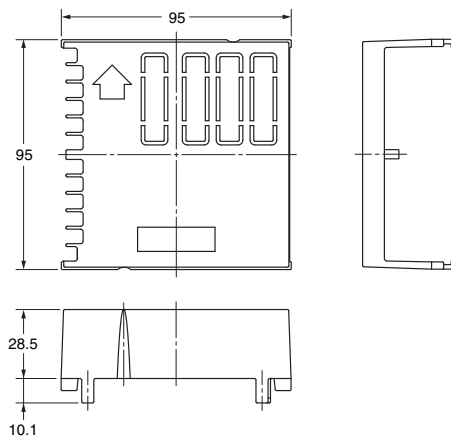
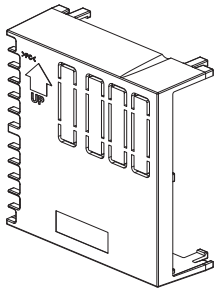

Unit Label Sheet

Y92S-L1

UNIT LABEL				
mV	V	mA	A	kW
mm	cm	m	km	g
kg	m ³	l	°C	°F
K	%RH	%	l/s	l/min
l/h	m ³ /s	m ³ /min	m ³ /h	kg/h
rpm	ppm	pH	kPa	mmHg
mmH ₂ O	mH ₂ O	bar	Torr	mmAq
kgf/cm ²	g/cm ²	kg/cm ²	kgf/cm ² G	kgf/cm ² G
TAG No.		TAG No.		

Rubber Packing

Y92S-P4 (for DIN96 × 96)

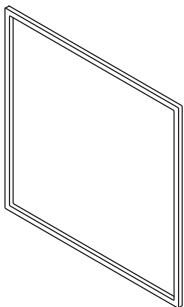

Order the Rubber Packing separately if it becomes lost or damaged. (Refer to page 3.)

The Rubber Packing can be used to achieve an IP66 degree of protection.

(Deterioration, shrinking, or hardening of the rubber packing may occur depending on the operating environment. Therefore, periodic replacement is recommended to ensure the level of waterproofing specified in NEMA4. The time for periodic replacement depends on the operating environment. Be sure to confirm this point at your site. Consider one year a rough standard. OMRON shall not be liable for the level of water resistance if the customer does not perform periodic replacement.)

The Rubber Packing does not need to be attached if a waterproof structure is not required.

Mounting Adapters

Y92H-9 (2pcs)

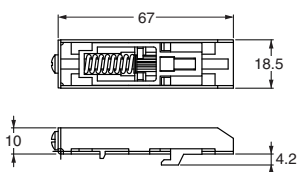

One set is packaged with the product.

Order Mounting Adapters separately if yours are lost or damaged.

ALL DIMENSIONS SHOWN ARE IN MILLIMETERS.

To convert millimeters into inches, multiply by 0.03937. To convert grams into ounces, multiply by 0.03527.

In the interest of product improvement, specifications are subject to change without notice.

Terms and Conditions Agreement

Read and understand this catalog.

Please read and understand this catalog before purchasing the products. Please consult your OMRON representative if you have any questions or comments.

Warranties.

(a) Exclusive Warranty. Omron's exclusive warranty is that the Products will be free from defects in materials and workmanship for a period of twelve months from the date of sale by Omron (or such other period expressed in writing by Omron). Omron disclaims all other warranties, express or implied.

(b) Limitations. OMRON MAKES NO WARRANTY OR REPRESENTATION, EXPRESS OR IMPLIED, ABOUT NON-INFRINGEMENT, MERCHANTABILITY OR FITNESS FOR A PARTICULAR PURPOSE OF THE PRODUCTS. BUYER ACKNOWLEDGES THAT IT ALONE HAS DETERMINED THAT THE PRODUCTS WILL SUITABLY MEET THE REQUIREMENTS OF THEIR INTENDED USE.

Omron further disclaims all warranties and responsibility of any type for claims or expenses based on infringement by the Products or otherwise of any intellectual property right. (c) Buyer Remedy. Omron's sole obligation hereunder shall be, at Omron's election, to (i) replace (in the form originally shipped with Buyer responsible for labor charges for removal or replacement thereof) the non-complying Product, (ii) repair the non-complying Product, or (iii) repay or credit Buyer an amount equal to the purchase price of the non-complying Product; provided that in no event shall Omron be responsible for warranty, repair, indemnity or any other claims or expenses regarding the Products unless Omron's analysis confirms that the Products were properly handled, stored, installed and maintained and not subject to contamination, abuse, misuse or inappropriate modification. Return of any Products by Buyer must be approved in writing by Omron before shipment. Omron Companies shall not be liable for the suitability or unsuitability or the results from the use of Products in combination with any electrical or electronic components, circuits, system assemblies or any other materials or substances or environments. Any advice, recommendations or information given orally or in writing, are not to be construed as an amendment or addition to the above warranty.

See <http://www.omron.com/global/> or contact your Omron representative for published information.

Limitation on Liability; Etc.

OMRON COMPANIES SHALL NOT BE LIABLE FOR SPECIAL, INDIRECT, INCIDENTAL, OR CONSEQUENTIAL DAMAGES, LOSS OF PROFITS OR PRODUCTION OR COMMERCIAL LOSS IN ANY WAY CONNECTED WITH THE PRODUCTS, WHETHER SUCH CLAIM IS BASED IN CONTRACT, WARRANTY, NEGLIGENCE OR STRICT LIABILITY.

Further, in no event shall liability of Omron Companies exceed the individual price of the Product on which liability is asserted.

Suitability of Use.

Omron Companies shall not be responsible for conformity with any standards, codes or regulations which apply to the combination of the Product in the Buyer's application or use of the Product. At Buyer's request, Omron will provide applicable third party certification documents identifying ratings and limitations of use which apply to the Product. This information by itself is not sufficient for a complete determination of the suitability of the Product in combination with the end product, machine, system, or other application or use. Buyer shall be solely responsible for determining appropriateness of the particular Product with respect to Buyer's application, product or system. Buyer shall take application responsibility in all cases.

NEVER USE THE PRODUCT FOR AN APPLICATION INVOLVING SERIOUS RISK TO LIFE OR PROPERTY OR IN LARGE QUANTITIES WITHOUT ENSURING THAT THE SYSTEM AS A WHOLE HAS BEEN DESIGNED TO ADDRESS THE RISKS, AND THAT THE OMRON PRODUCT(S) IS PROPERLY RATED AND INSTALLED FOR THE INTENDED USE WITHIN THE OVERALL EQUIPMENT OR SYSTEM.

Programmable Products.

Omron Companies shall not be responsible for the user's programming of a programmable Product, or any consequence thereof.

Performance Data.

Data presented in Omron Company websites, catalogs and other materials is provided as a guide for the user in determining suitability and does not constitute a warranty. It may represent the result of Omron's test conditions, and the user must correlate it to actual application requirements. Actual performance is subject to the Omron's Warranty and Limitations of Liability.

Change in Specifications.

Product specifications and accessories may be changed at any time based on improvements and other reasons. It is our practice to change part numbers when published ratings or features are changed, or when significant construction changes are made. However, some specifications of the Product may be changed without any notice. When in doubt, special part numbers may be assigned to fix or establish key specifications for your application. Please consult with your Omron's representative at any time to confirm actual specifications of purchased Product.

Errors and Omissions.

Information presented by Omron Companies has been checked and is believed to be accurate; however, no responsibility is assumed for clerical, typographical or proofreading errors or omissions.

2016.9

In the interest of product improvement, specifications are subject to change without notice.

OMRON Corporation
Industrial Automation Company

<http://www.ia.omron.com/>

(c)Copyright OMRON Corporation 2016 All Right Reserved.