



MicroSynth® INTEGRATED SYNTHESIZER MODULE, 5.5 - 10.5 GHz



Features

- Extremely Compact, Broadband Synthesizer
- 24-Bit Step Size, 1.2 Hz Resolution
- Auto and Triggered Sweeper Functions
- Integrated Low Noise Voltage Regulators
- Hermetic Module
- Operating Temperature: -40°C to +85°C
- Class 2 ESD Rating (2 kV)

Typical Applications

The HMC-C070 is ideal for:

- Military Radar, EW & ECM
- Test & Measurement Equipment
- Lab Instrumentation
- Industrial/Medical Equipment

General Description

The HMC-C070 MicroSynth® is a fully integrated broadband synthesizer module that combines high performance SiGe, GaAs pHEMT, and InGaP HBT technologies into one compact hermetic package. The output frequency range is 5.5 to 10.5 GHz with an average output power of +21 dBm, which is enough to drive two mixers. In fractional-N mode, the HMC-C070 can realize step sizes as low as 1.2 Hz. The HMC-C070 also features fully integrated low noise regulators and an output buffer amplifier which results in superior pushing and pulling performance. This module has been designed to withstand harsh environments and can be upscrambled to higher military standards upon request.

For theory of operation and register map refer to the MicroSynth® Operating Guide. To view the [Operating Guide](http://www.hittite.com), please visit www.hittite.com and choose HMC-C070 from the "Search by Part Number" pull down menu.

Functional Diagram

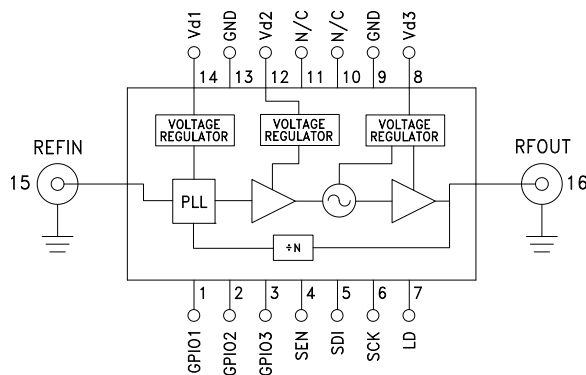

Electrical Specifications, $T_A = +25^\circ\text{C}$, $V_{d1} = 3.6\text{V}$, $V_{d2} = 20\text{V}$, $V_{d3} = 6\text{V}$

| Parameter | Min. | Typ. | Max. | Units |
|---|------------|------|------|---------------|
| Frequency Range | 5.5 - 10.5 | | | GHz |
| Power Output, 5.5 - 9.5 GHz | 19 | 21 | | dBm |
| Power Output, 9.5 - 10.5 GHz | 17.5 | 21 | | dBm |
| Phase Noise @ 100 Hz Offset | | -78 | | dBc/Hz |
| Phase Noise @ 1 kHz Offset | | -85 | | dBc/Hz |
| Phase Noise @ 10 kHz Offset | | -87 | | dBc/Hz |
| Phase Noise @ 100 kHz Offset | | -90 | | dBc/Hz |
| Phase Noise @ 1 MHz Offset | | -117 | | dBc/Hz |
| Reference Spur (@ 10 MHz) | -45 | -55 | | dBc |
| Second Harmonic | | -20 | | dBc |
| Third Harmonic | | -25 | | dBc |
| Prescaler Coefficient (M) | | 2 | | |
| Phase Settling Time (<3 degrees), 20 MHz Step | | 150 | | μS |

Information furnished by Analog Devices is believed to be accurate and reliable. However, no responsibility is assumed by Analog Devices for its use, nor for any infringements of patents or other rights of third parties that may result from its use. Specifications subject to change without notice. No license is granted by implication or otherwise under any patent or patent rights of Analog Devices. Trademarks and registered trademarks are the property of their respective owners.

For price, delivery, and to place orders: Analog Devices, Inc., One Technology Way, P.O. Box 9106, Norwood, MA 02062-9106
 Phone: 781-329-4700 • Order online at www.analog.com
 Application Support: Phone: 1-800-ANALOG-D

HMC-C070* PRODUCT PAGE QUICK LINKS

Last Content Update: 02/23/2017

COMPARABLE PARTS

View a parametric search of comparable parts.

DOCUMENTATION

Data Sheet

- HMC-C070 Data Sheet

User Guides

- Microsynth® Integrated Hermetic Synthesizer Product & Operating Guide

REFERENCE MATERIALS

Technical Articles

- New MicroSynth™ Integrated Hermetic Synthesizer Module

DESIGN RESOURCES

- HMC-C070 Material Declaration
- PCN-PDN Information
- Quality And Reliability
- Symbols and Footprints

DISCUSSIONS

View all HMC-C070 EngineerZone Discussions.

SAMPLE AND BUY

Visit the product page to see pricing options.

TECHNICAL SUPPORT

Submit a technical question or find your regional support number.

DOCUMENT FEEDBACK

Submit feedback for this data sheet.

MicroSynth® INTEGRATED SYNTHESIZER MODULE, 5.5 - 10.5 GHz



Electrical Specifications, (Continued)

| Parameter | Min. | Typ. | Max. | Units |
|--|------|------|------|-------|
| Phase Settling Time (<3 degrees), 5 GHz Step | | 15 | | mS |
| Output Return Loss | | 13 | | dB |
| Loop Bandwidth | | 150 | | kHz |
| Reference (comparison) Frequency | | 10 | | MHz |
| Reference Input Power | -6 | 0 | 12 | dBm |
| Voltage Supply (Vd1) | 3.3 | 3.6 | 12 | V |
| Supply Current (Id1) | | 100 | 125 | mA |
| Voltage Supply (Vd2) | 19 | 20 | 20.5 | V |
| Supply Current (Id2) | | 20 | 25 | mA |
| Voltage Supply (Vd3) | 5.5 | 6 | 12 | V |
| Supply Current (Id3) | | 300 | 375 | mA |
| Total DC Power Dissipation | | 2.5 | 6.5 | W |

Output Power vs. Frequency

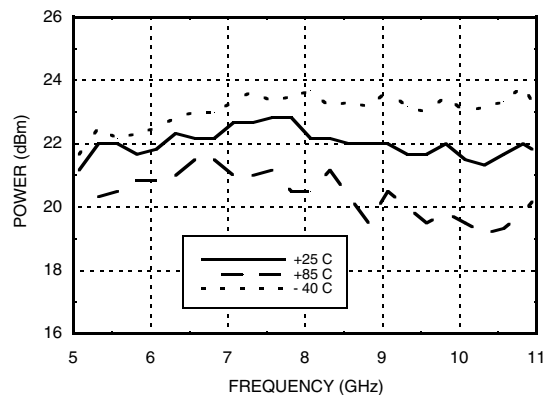

Phase Noise @ 5.5 GHz, Integer Mode

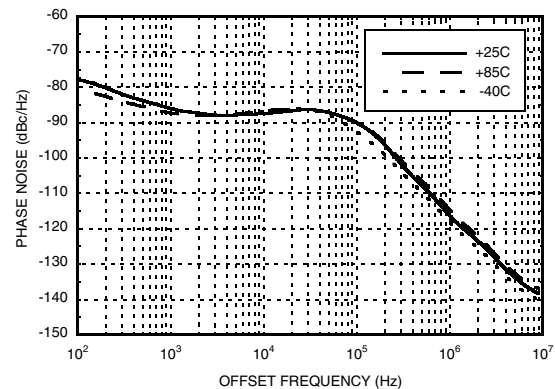

Phase Noise @ 7.5 GHz, Integer Mode

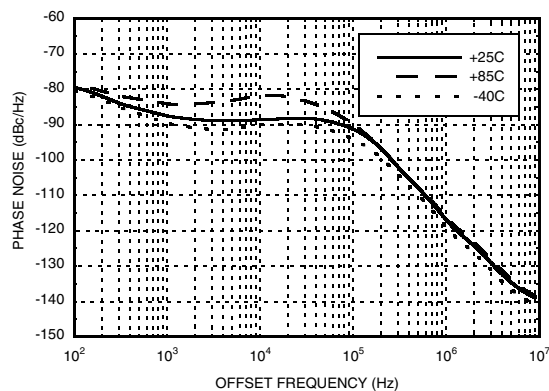

Phase Noise @ 10 GHz, Integer Mode

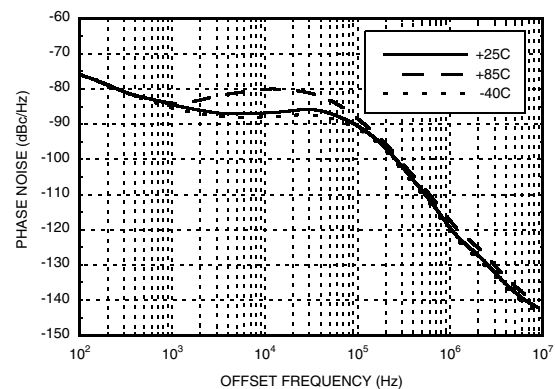

Information furnished by Analog Devices is believed to be accurate and reliable. However, no responsibility is assumed by Analog Devices for its use, nor for any infringements of patents or other rights of third parties that may result from its use. Specifications subject to change without notice. No license is granted by implication or otherwise under any patent or patent rights of Analog Devices. Trademarks and registered trademarks are the property of their respective owners.

For price, delivery, and to place orders: Analog Devices, Inc., One Technology Way, P.O. Box 9106, Norwood, MA 02062-9106 Phone: 781-329-4700 • Order online at www.analog.com Application Support: Phone: 1-800-ANALOG-D



MicroSynth® INTEGRATED SYNTHESIZER MODULE, 5.5 - 10.5 GHz

Reference Spur

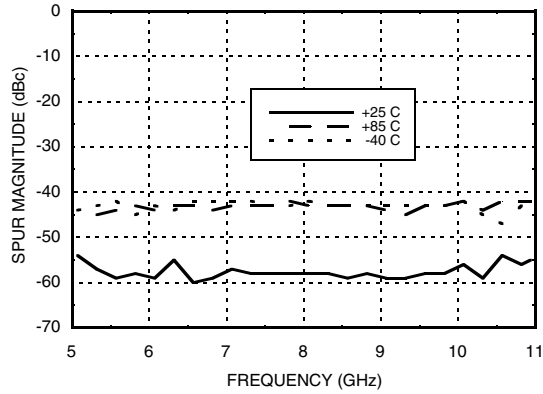

Second Harmonic vs. Frequency

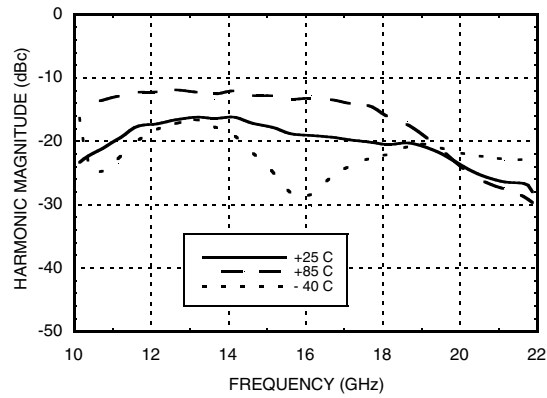

Third Harmonic vs. Frequency

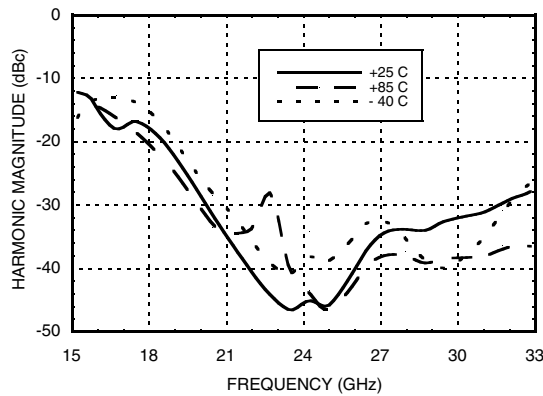

Absolute Maximum Ratings

| | |
|---|----------------|
| Vd1 | 12 V |
| Vd2 | 20.5 V |
| Vd3 | 12 V |
| GPI01, GPI02, GPI03, SEN, SDI, SCK & LD | 3.6 V |
| Continuous Pdiss (T = 85°C) (derate 68.9 mW/°C above 85°C) | 6.5 W |
| Storage Temperature | -55 to +125 °C |
| Operating Temperature | -40 to +85 °C |



**ELECTROSTATIC SENSITIVE DEVICE
OBSERVE HANDLING PRECAUTIONS**

Information furnished by Analog Devices is believed to be accurate and reliable. However, no responsibility is assumed by Analog Devices for its use, nor for any infringements of patents or other rights of third parties that may result from its use. Specifications subject to change without notice. No license is granted by implication or otherwise under any patent or patent rights of Analog Devices. Trademarks and registered trademarks are the property of their respective owners.

For price, delivery, and to place orders: Analog Devices, Inc., One Technology Way, P.O. Box 9106, Norwood, MA 02062-9106
Phone: 781-329-4700 • Order online at www.analog.com
Application Support: Phone: 1-800-ANALOG-D

MicroSynth® INTEGRATED SYNTHESIZER MODULE, 5.5 - 10.5 GHz



Outline Drawing

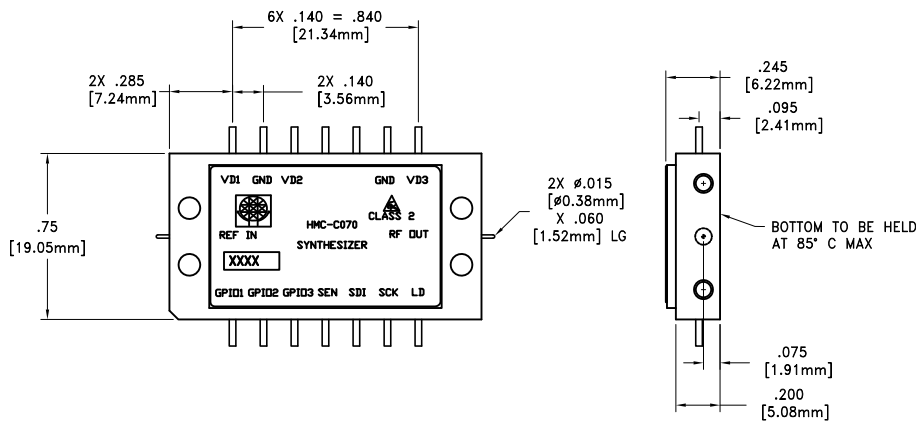
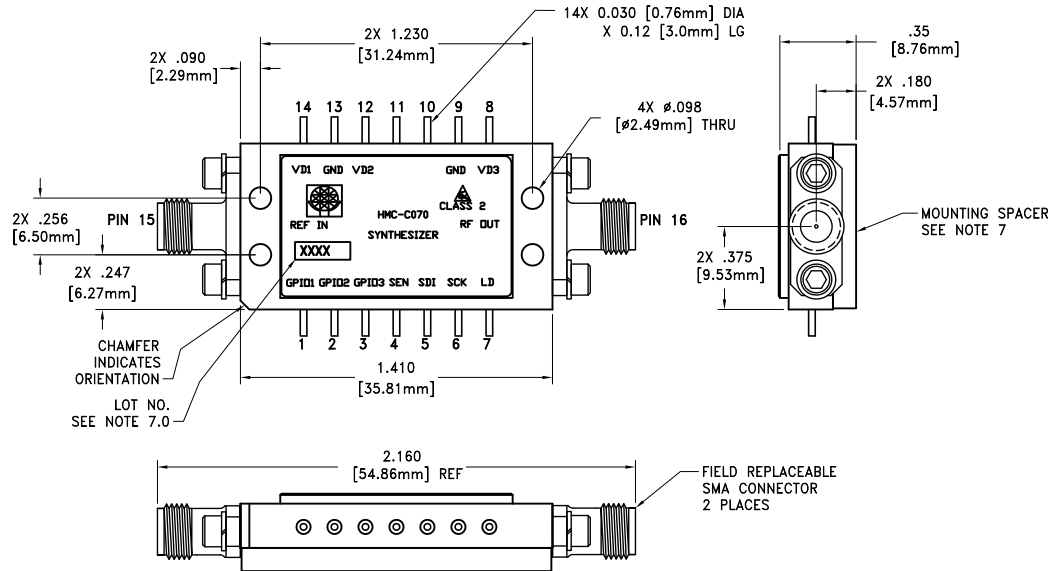

Package Information



| | |
|-------------------------------|--------|
| Package Type | C-20 |
| Package Weight ^[1] | 16.53g |
| Spacer Weight | 4.6g |

[1] Does not include connectors, or mounting hardware

NOTES:

- 1.0 PACKAGE, LEADS, COVER MATERIAL: KOVAR™
- 2.0 FINISH: GOLD PLATE OVER NICKEL PLATE.
- 4.0 ALL DIMENSIONS ARE IN INCHES [MILLIMETERS].
- 5.0 TOLERANCES: UNLESS OTHERWISE SPECIFIED
- 5.1 .XX = ±0.02 [0.51]
.XXX = ±0.010 [0.25]
- 6.0 MARK LOT NUMBER ON 0.080 X 0.250 LABEL WHERE SHOWN WITH 0.030" MIN TEXT HEIGHT.
- 7.0 MOUNTING SPACER PART NUMBER 123279.

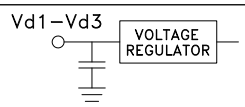
**MicroSynth® INTEGRATED
SYNTHESIZER MODULE, 5.5 - 10.5 GHz**
Pin Descriptions

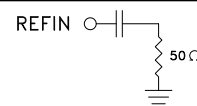
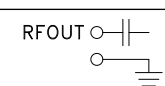
| Pin Number | Function | Description | Interface Schematic |
|------------|---------------------|--|--|
| 1 - 3 | GPIO1, GPIO2, GPIO3 | General Purpose I/O with Tristate, 3.3 V Logic | See operating guide. [1] |
| 4 | SEN | Serial port Enable Input, 3.3 V Logic | See operating guide. [1] |
| 5 | SDI | Serial port Data input, 3.3 V Logic | See operating guide. [1] |
| 6 | SCK | Serial port Clock input, 3.3 V Logic | See operating guide. [1] |
| 7 | LD | Lock Detect, 3.3 V Logic | See operating guide. [1] |
| 8, 12, 14 | Vd3, Vd2, Vd1 | Voltage Supply Pins |  |
| 9, 13 | GND | These pins must be connected to RF/DC ground. |  |
| 10, 11 | N/C | Please leave these pins open as they are reserved for future product improvements. | |
| 15 | REFIN | Reference input, 10 MHz nominal, 220 MHz maximum. Note: the comparison frequency (reference freq./R) may not exceed 75 MHz and the module performance is not specified at comparison frequencies other than 10 MHz. |  |
| 16 | RFOUT | Synthesizer RF output. |  |

[1] To view the [Operating Guide](#), please visit www.hittite.com and choose HMC-C070 from the "Search by Part Number" pull down menu.

MicroSynth[®] INTEGRATED
SYNTHESIZER MODULE, 5.5 - 10.5 GHz

Notes: