

PRODUCT NUMBER
SEE PART NO. TABLE

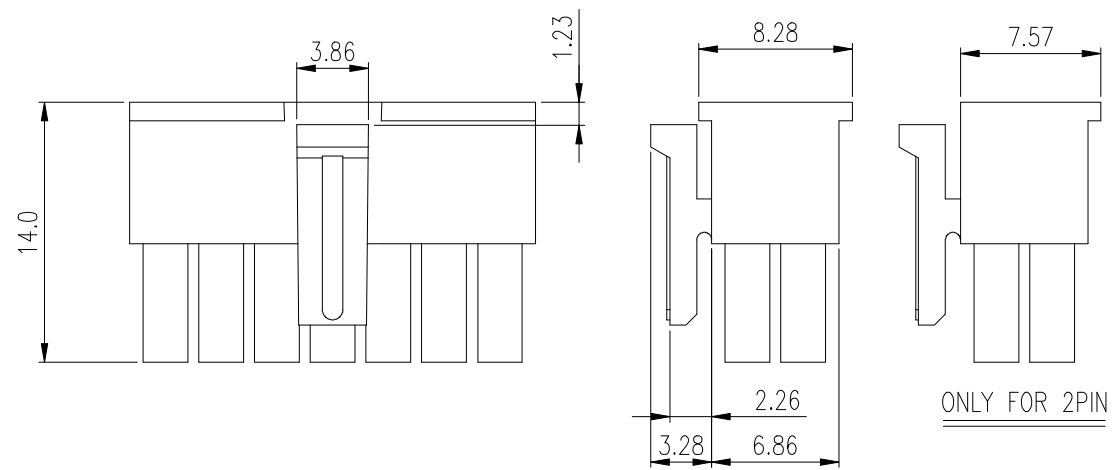

ONLY FOR 2PIN

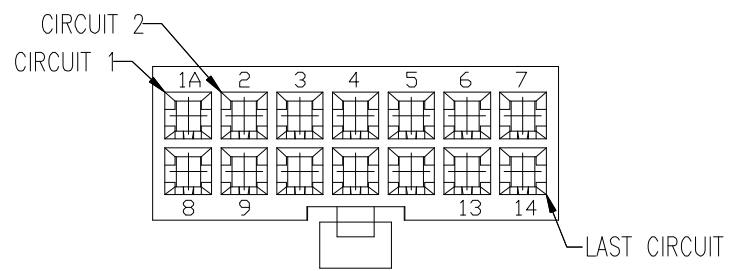
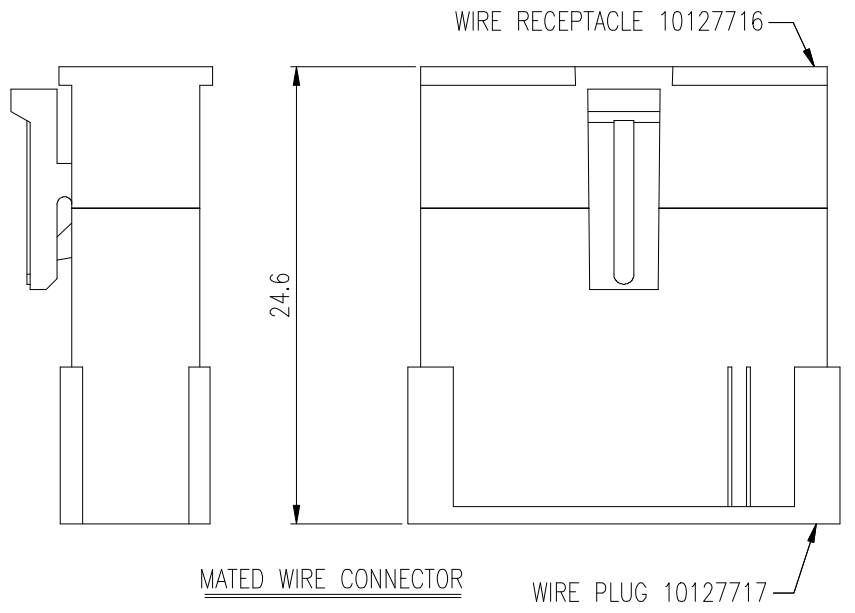
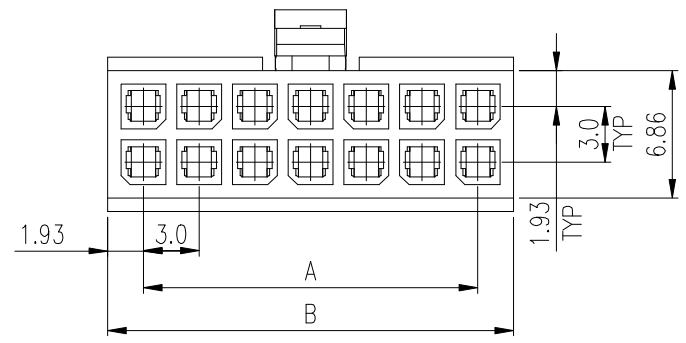

MATED WIRE CONNECTOR

- NOTES:
1. MATERIAL: NYLON 66, UL 94V-0, BLACK.
 2. THIS HSG IS USED WITH FCI RECEPTACLE TERMINAL 10127718.
 3. THIS RECEPTACLE MATES WITH FCI PLUG 10127717, 10127720 & 10127721.
 4. PRODUCT SPECIFICATION: GS-12-1177.
 5. PACKAGE SPECIFICATION: GS-14-2359.
 6. PART NUMBER SCHEME:
10127716- XX LF

POS. CODE:
02: 2 POS.
04: 4 POS.
5
24: 24 POS.

DIMENSIONAL & PART NO. TABLE:

PART NO.	POS	A	B
10127716-02LF	2	3.85	3.85
10127716-04LF	4	3.0	6.85
10127716-06LF	6	6.0	9.85
10127716-08LF	8	9.0	12.85
10127716-10LF	10	12.0	15.85
10127716-12LF	12	15.0	18.85
10127716-14LF	14	18.0	21.85
10127716-16LF	16	21.0	24.85
10127716-18LF	18	24.0	27.85
10127716-20LF	20	27.0	30.85
10127716-22LF	22	30.0	33.85
10127716-24LF	24	33.0	36.85

mat'l. code		surface		tolerance		projection		product family	
ltr		ecn no		dr		date		tolerances unless otherwise specified	
A		TAI		2013-10-21		angles		X.X ±0.3	
						line		X.XX ±0.2	
						X*±2°		scale	
		dr		KENNY TAI		2013-10-21		scale	
		enr		KENNY TAI		2013-10-21		FCI	
		chr		KENNY TAI		2013-10-21		dwg no	
		appd		PM ZHENG		2013-11-06		sheet 1 of 2	
sheet index		revision sheet		A 1		A 2		size	
								10127716	
								A4	
								type	
								CUSTOMER Drawing	

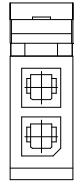

2 POS

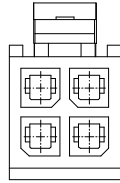

4 POS

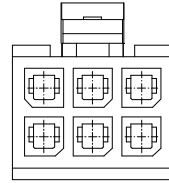

6 POS

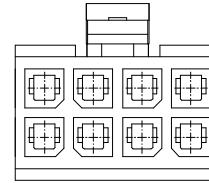

8 POS

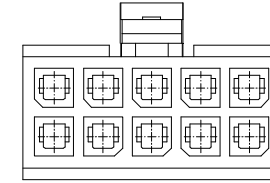

10 POS

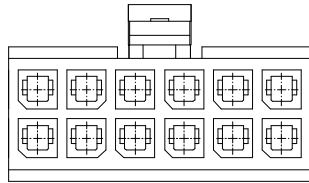

12 POS

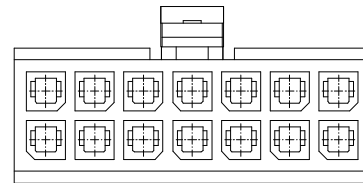

14 POS

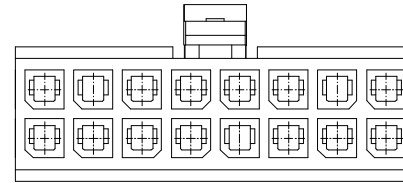

16 POS

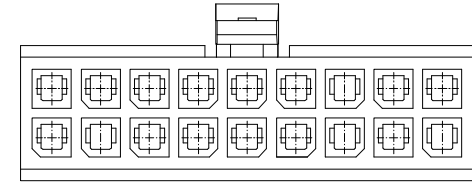

18 POS

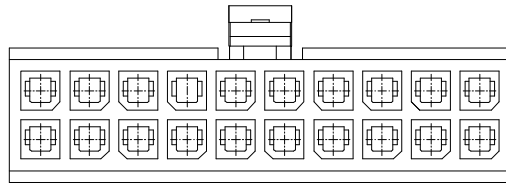

20 POS

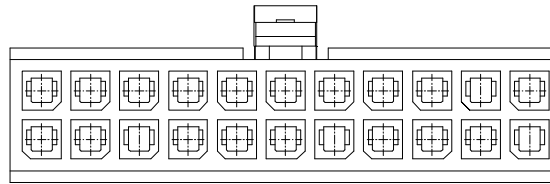

22 POS

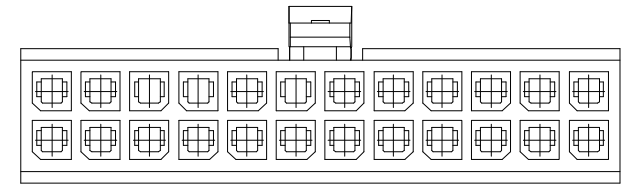

24 POS

mat'l. code		surface <input checked="" type="checkbox"/>		tolerance		projection		product family	
ltr		ecn no		dr		date		title	
								RECEPTACLE HSG, DUAL ROW, FOR 3mm PITCH WIRE CONNECTOR	
				angles		X.X ±0.3		scale	
						X.XX ±0.2		MM	
				X*±2°				scale	
				dr		KENNY TAI 2013-10-21		dwg no	
				enr		KENNY TAI 2013-10-21		sheet 2 of 2	
				chr		KENNY TAI 2013-10-21		size	
				appd		PM ZHENG 2013-11-06		A4	
sheet index		revision sheet		A 1		A 2		type	
								CUSTOMER Drawing	

