

SP3021 Series 0.5pF 8kV Bidirectional Discrete TVS

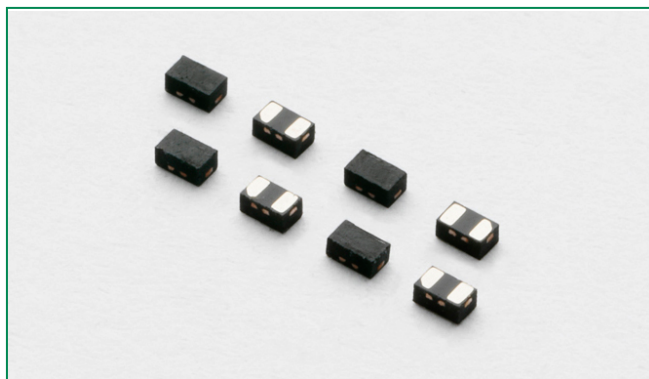

Pinout

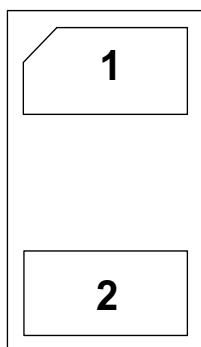

Functional Block Diagram

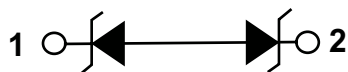

Additional Information



Datasheet



Resources



Samples

Life Support Note:

Not Intended for Use in Life Support or Life Saving Applications

The products shown herein are not designed for use in life sustaining or life saving applications unless otherwise expressly indicated.

Description

The SP3021 includes back-to-back TVS diodes fabricated in a proprietary silicon avalanche technology to provide protection for electronic equipment that may experience destructive electrostatic discharges (ESD). These robust diodes can safely absorb repetitive ESD strikes up to the maximum level specified in the IEC 61000-4-2 international standard without performance degradation. The back-to-back configuration provides symmetrical ESD protection for data lines when AC signals are present.

Features

- ESD protection of $\pm 8\text{kV}$ contact discharge, $\pm 15\text{kV}$ air discharge, (IEC 61000-4-2)
- EFT, IEC 61000-4-4, 40A (5/50ns)
- Lightning protection, IEC 61000-4-5 2nd edition ($t_p=8/20\mu\text{s}$)
- Low capacitance of 0.5pF @ $V_R=0\text{V}$
- Low leakage current of 1 μA at 5V
- 0402 small footprint available
- RoHS compliant, lead-free and halogen free

Applications

- USB 3.0/USB 2.0
- MHL/MIPI/MDDI
- HDMI, Display Port, eSATA
- Set Top Boxes, Game Consoles
- Smart Phones
- External Storage
- Ultrabooks, Notebooks
- Tablets, eReaders

USB3.0 Application Example

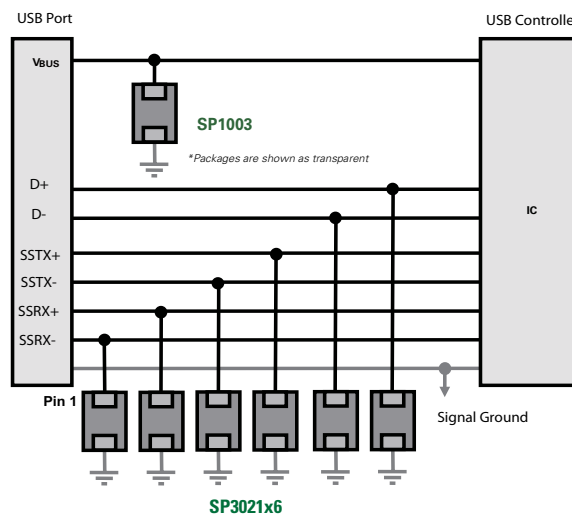

Absolute Maximum Ratings

Symbol	Parameter	Value	Units
I_{PP}	Peak Current ($t_p=8/20\mu s$)	2.0	A
T_{OP}	Operating Temperature	-40 to 125	°C
T_{STOR}	Storage Temperature	-55 to 150	°C

CAUTION: Stresses above those listed in "Absolute Maximum Ratings" may cause permanent damage to the device. This is a stress only rating and operation of the device at these or any other conditions above those indicated in the operational sections of this specification is not implied.

Thermal Information

Parameter	Rating	Units
Storage Temperature Range	-55 to 150	°C
Maximum Junction Temperature	150	°C
Maximum Lead Temperature (Soldering 20-40s)	260	°C

Electrical Characteristics ($T_{OP}=25^\circ C$)

Parameter	Symbol	Test Conditions	Min	Typ	Max	Units
Reverse Standoff Voltage	V_{RWM}				5.0	V
Reverse Breakdown Voltage	V_{BR}	$I_R=1mA$	7.0			V
Reverse Leakage Current	I_{LEAK}	$V_R=5V$			1	μA
Clamp Voltage ¹	V_C	$I_{pp}=1A, t_p=8/20\mu s, Fwd$		13.1		V
		$I_{pp}=2A, t_p=8/20\mu s, Fwd$		14.7		V
Dynamic Resistance	R_{DYN}	$(V_{C2}-V_{C1})/(I_{PP2}-I_{PP1})$		1.6		Ω
ESD Withstand Voltage ¹	V_{ESD}	IEC61000-4-2 (Contact)	± 8			kV
		IEC61000-4-2 (Air)	± 15			kV
Diode Capacitance ¹	C_D	Reverse Bias=0V		0.5		pF

Note: 1. Parameter is guaranteed by design and/or device characterization.

Capacitance vs. Bias Voltage

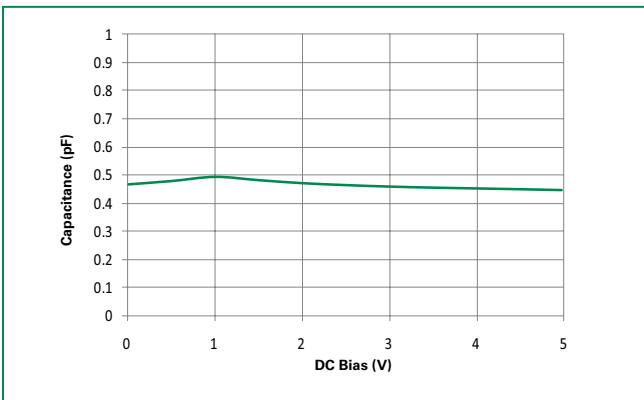

Insertion Loss (S21) I/O to GND

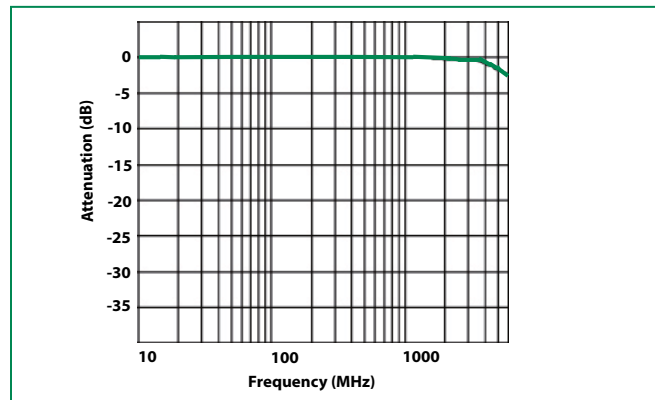

Pulse Waveform

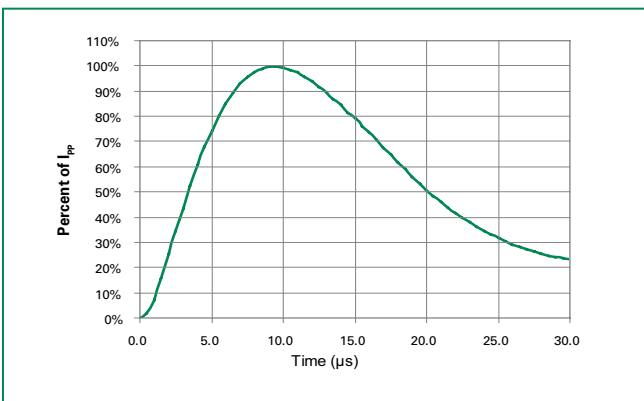

Transmission Line Pulsing (TLP) Plot

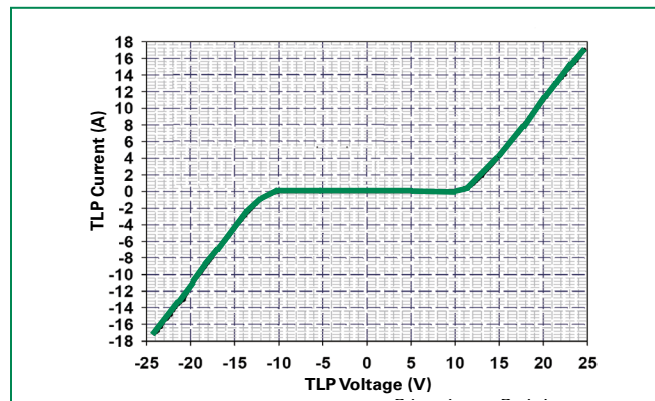

Product Characteristics

Lead Plating	Pre-Plated Frame or Matte Tin
Lead Material	Copper Alloy
Lead Coplanarity	0.0004 inches (0.102mm)
Substitute Material	Silicon
Body Material	Molded Epoxy
Flammability	UL 94 V-0

Notes :

1. All dimensions are in millimeters
2. Dimensions include solder plating.
3. Dimensions are exclusive of mold flash & metal burr.
4. Blo is facing up for mold and facing down for trim/form, i.e. reverse trim/form.
5. Package surface matte finish VDI 11-13.

Ordering Information

Part Number	Package	Marking	Min. Order Qty.
SP3021-01ETG	SOD882	• -	12000

Soldering Parameters

Reflow Condition		Pb – Free assembly
Pre Heat	- Temperature Min ($T_{s(min)}$)	150°C
	- Temperature Max ($T_{s(max)}$)	200°C
	- Time (min to max) (t_s)	60 – 180 secs
Average ramp up rate (Liquidus) Temp (T_L) to peak		3°C/second max
$T_{s(max)}$ to T_L - Ramp-up Rate		3°C/second max
Reflow	- Temperature (T_L) (Liquidus)	217°C
	- Temperature (t_l)	60 – 150 seconds
Peak Temperature (T_p)		260 ^{+0/-5} °C
Time within 5°C of actual peak Temperature (t_p)		20 – 40 seconds
Ramp-down Rate		6°C/second max
Time 25°C to peak Temperature (T_p)		8 minutes Max.
Do not exceed		260°C

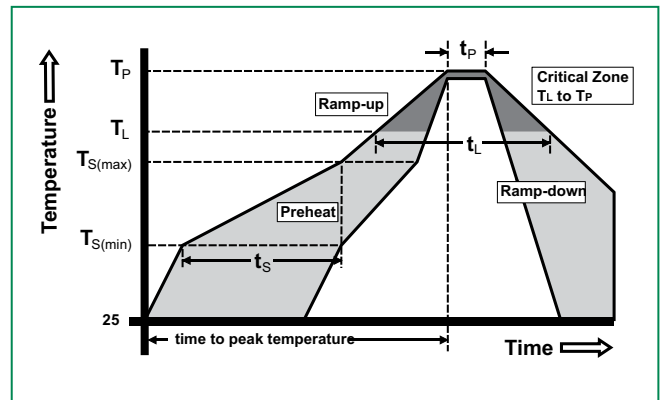

Part Numbering System

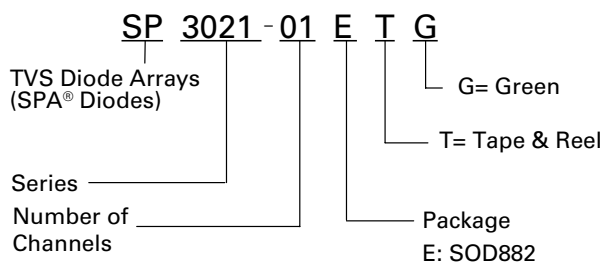

Part Marking System

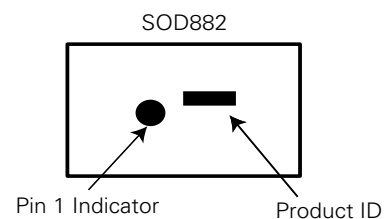

Package Dimensions – SOD882

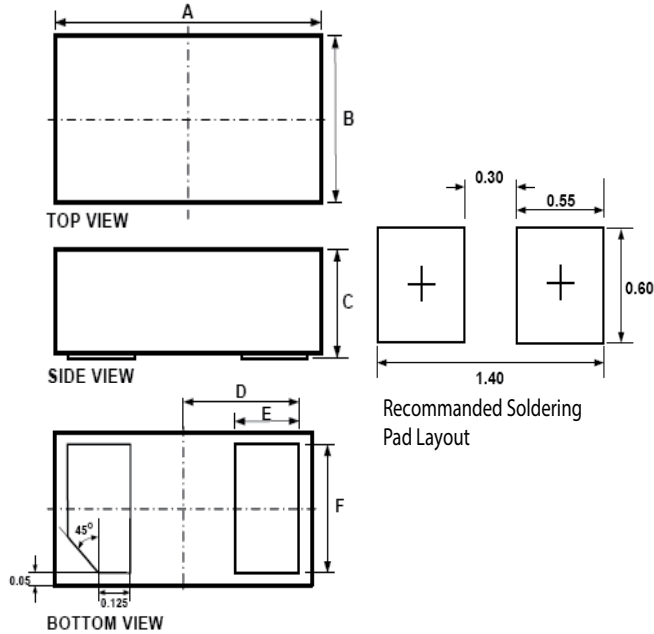

Symbol	Package	SOD882				
	JEDEC	MO-236				
	Millimeters			Inches		
	Min	Typ	Max	Min	Typ	Max
A	0.90	1.00	1.10	0.035	0.039	0.043
B	0.50	0.60	0.70	0.020	0.024	0.028
C	0.40	0.50	0.60	0.016	0.020	0.024
D	0.45			0.018		
E	0.20	0.25	0.35	0.008	0.010	0.012
F	0.45	0.50	0.55	0.018	0.020	0.022

Embossed Carrier Tape & Reel Specification – SOD882

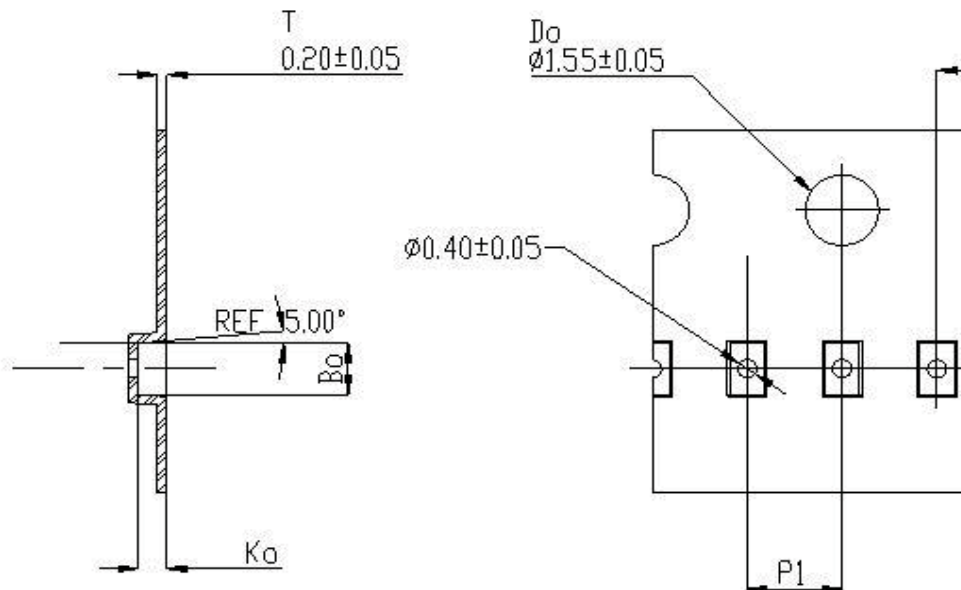

Symbol	Millimeters
A0	0.70 ± 0.045
B0	1.10 ± 0.045
K0	0.65 ± 0.045
F	3.50 ± 0.05
P1	2.00 ± 0.10
W	$8.00 + 0.30 - 0.10$

Notes :
1. All dimensions are in millimeters

Disclaimer Notice - Information furnished is believed to be accurate and reliable. However, users should independently evaluate the suitability of and test each product selected for their own applications. Littelfuse products are not designed for, and may not be used in, all applications. Read complete Disclaimer Notice at www.littelfuse.com/disclaimer-electronics.