



# MOP-GL24064R

---

## Parallel Display Specifications

Revision 1.0

## Revision History

Revision	Date	Description	Author
1.0	March 21, 2012	Initial Release	Clark

## Contents

Revision History .....	1
Contents .....	2
Features .....	3
Hardware .....	3
Drawing .....	3
Interface .....	3
Instructions .....	4
Outline .....	4
Instruction Table .....	5
Timing Characteristics .....	6
Specifications .....	7
Electrical .....	7
Optical .....	7
Environmental .....	7
Troubleshooting .....	8
Power .....	8
Display .....	8
Communication .....	8
Precautions .....	8
Ordering .....	9
Part Numbering Scheme .....	9
Options .....	9
Contact .....	9

## Features

The Matrix Orbital Parallel display series offers a low cost display solution utilizing an industry standard communication interface for simple integration into a wide variety of new and existing applications. The Light Emitting Diode backlight with configurable brightness and voltage controlled contrast allows the MOP Liquid Crystal Display line to offer a professional display solution for any project.

## Hardware

### Drawing

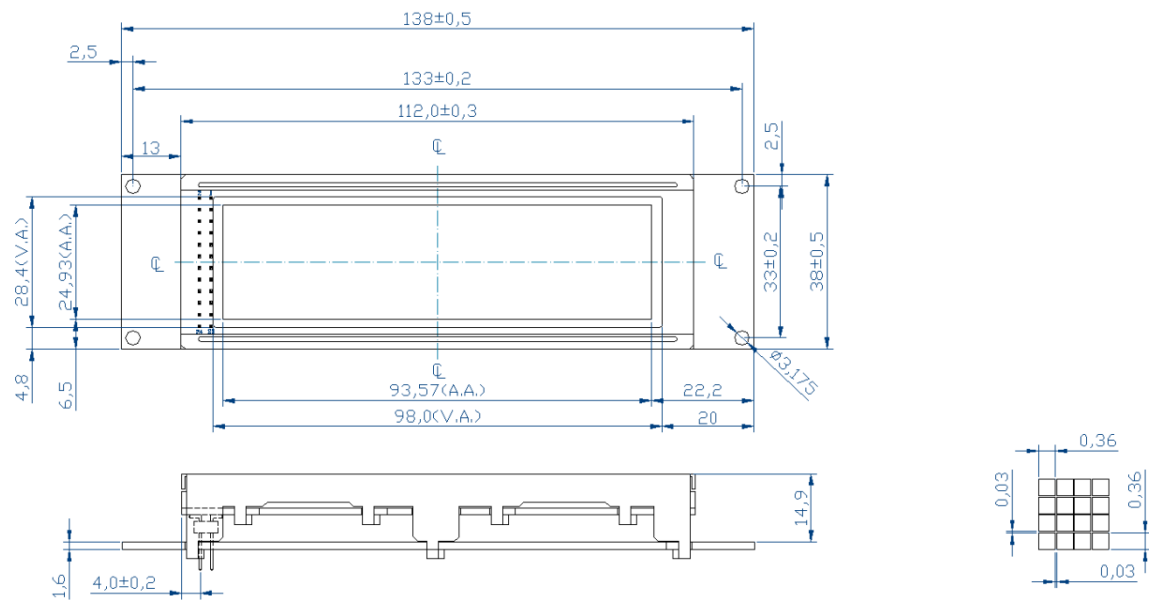

Figure 1: MOP-GL24064A Mechanical Drawing

## Interface

Table 1: Display Control

Pin	Symbol	Description
1	FGnd	Frame Ground
2	V <sub>SS</sub>	Ground
3	V <sub>DD</sub>	Supply Voltage for Logic
4	V <sub>0</sub>	Supply Voltage for LCD (Contrast)
5	WR	Write
6	RD	Read
7	CS	Chip Enable
8	C/D	Command/Data
9	NC	No Connect
10	RST	Reset
19	FS	Font Select
20	V <sub>EE</sub>	*Negative Voltage Output

\*Note: Offered on applicable units only

Table 2: Parallel Data and Backlight

Pin	Symbol	Description
11	DB0	Data bit 0
12	DB1	Data bit 1
13	DB2	Data bit 2
14	DB3	Data bit 3
15	DB4	Data bit 4
16	DB5	Data bit 5
17	DB6	Data bit 6
18	DB7	Data bit 7
21	LEDR	Red Backlight Anode
22	**LEDG	Green Backlight Anode
23	LEDB	Blue Backlight Anode
24	LEDK	Backlight Cathode

\*\*Note: LEDG is anode for single colour backlights

# Instructions

## Outline

The MOP-GL24064R is controlled using a standard T6963 compliant controller. The display is enabled by pulling the Chip Select (CS) pin low, communication to and from the device is controlled using the active low Write (WR) and Read (RD) inputs, and the unit may be reset by pulling the RST line low. Using Register Select, either the Command Register (C) or Data Register (D) is selected by toggling C/D high or low respectively.

Before any data is read or written, the status of the display controller must be read. This is accomplished by setting RD low, WR high, CS low, C/D high, and reading the status byte that appears on the data lines. Each bit of the status word indicates a specific condition, outlined below.

Table 3: Status Bits

Bit	Description	Status
D0	Command execution capability.	0:Disabled, 1:Enabled.
D1	Data read/write capability.	0:Disabled, 1:Enabled.
D2	Auto mode data read capability.	0:Disabled, 1:Enabled.
D3	Auto mode data write capability.	0:Disabled, 1:Enabled.
D4	Unused.	Unused.
D5	Controller operation capability.	0:Disabled, 1:Enabled.
D6	Screen peek/copy error flag.	0:No Error, 1:Error.
D7	Blink condition.	0:Display Off, 1:Normal Display.

The first two bits, D0 and D1, should be read at the same time. In auto mode, D2 and D3 become valid while D0 and D1 are invalid. The display should be in an enabled condition before commands or data are transmitted. Data bytes are transferred before commands, as shown below.

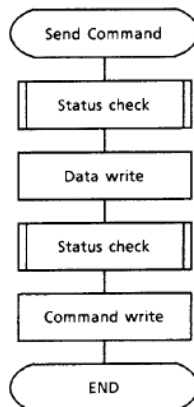

Figure 2: Single Byte Command

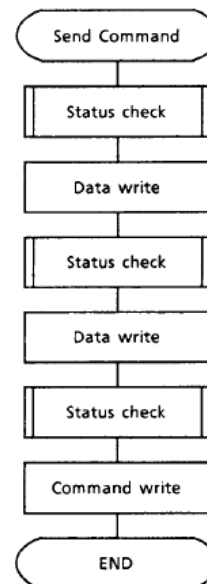

Figure 3: Two Byte Command

## Instruction Table

Table 4: Parallel Instruction Table

Instruction	Instruction Code								Data 1	Data 2
	DB7	DB6	DB5	DB4	DB3	DB2	DB1	DB0		
Set Cursor Pointer	0	0	1	0	0	0	0	1	X Address	Y Address
Set Offset Register	0	0	1	0	0	0	1	0	Data	0
Set Address Pointer	0	0	1	0	0	1	0	0	Low Address	High Address
Set Text Home Address	0	1	0	0	0	0	0	0	N/A	N/A
Set Text Address	0	1	0	0	0	0	0	1	N/A	N/A
Set Graphic Home Address	0	1	0	0	0	0	1	0	N/A	N/A
Set Graphic Area	0	1	0	0	0	0	1	1	N/A	N/A
Set OR Mode	1	0	0	0	X	0	0	0	N/A	N/A
Set EXOR Mode	1	0	0	0	X	0	0	0	N/A	N/A
Set AND Mode	1	0	0	0	X	0	0	1	N/A	N/A
Text Attribute Mode	1	0	0	0	X	0	1	1	N/A	N/A
Internal CG ROM Mode	1	0	0	0	0	X	X	X	N/A	N/A
External CG RAM Mode	1	0	0	0	1	X	X	X	N/A	N/A
Display Off	1	0	0	1	0	0	0	0	N/A	N/A
Cursor On, Blink Off	1	0	0	1	X	X	1	0	N/A	N/A
Cursor On, Blink On	1	0	0	1	X	X	1	1	N/A	N/A
Text On, Graphic Off	1	0	0	1	0	1	X	X	N/A	N/A
Text Off, Graphic On	1	0	0	1	1	0	X	X	N/A	N/A
Text On, Graphic On	1	0	0	1	1	1	X	X	N/A	N/A
1-Line Cursor	1	0	1	0	0	0	0	0	N/A	N/A
2-Line Cursor	1	0	1	0	0	0	0	1	N/A	N/A
3-Line Cursor	1	0	1	0	0	0	1	0	N/A	N/A
4-Line Cursor	1	0	1	0	0	0	1	1	N/A	N/A
5-Line Cursor	1	0	1	0	0	1	0	0	N/A	N/A
6-Line Cursor	1	0	1	0	0	1	0	1	N/A	N/A
7-Line Cursor	1	0	1	0	0	1	1	0	N/A	N/A
8-Line Cursor	1	0	1	0	0	1	1	1	N/A	N/A
Set Data Auto Write	1	0	1	1	0	0	0	0	N/A	N/A
Set Data Auto Read	1	0	1	1	0	0	0	1	N/A	N/A
Auto Reset	1	0	1	1	0	0	1	0	N/A	N/A
Write and Increment Pointer	1	1	0	0	0	0	0	0	Data	N/A
Read and Increment Pointer	1	1	0	0	0	0	0	1	N/A	N/A
Write and Decrement Pointer	1	1	0	0	0	0	1	0	Data	N/A
Read and Decrement Pointer	1	1	0	0	0	0	1	1	N/A	N/A
Write and Leave Pointer	1	1	0	0	0	1	0	0	Data	N/A
Read and Leave Pointer	1	1	0	0	0	1	0	1	N/A	N/A
Screen Peek	1	1	1	0	0	0	0	0	N/A	N/A
Screen Copy	1	1	1	0	1	0	0	0	N/A	N/A
Bit Reset	1	1	1	1	0	B	I	T	N/A	N/A
Bit Set	1	1	1	1	1	B	I	T	N/A	N/A

## Timing Characteristics

Table 5: Read and Write Operation Specifications

Item	Symbol	Min	Typ	Max	Unit
C/D Set-Up Time	$t_{CDS}$	100	—	—	ns
C/D Hold Time	$t_{CDH}$	10	—	—	ns
CE, RD, WR Pulse Width	$t_{CE}, t_{RD}, t_{WR}$	80	—	—	ns
Data Set-Up Time	$t_{DS}$	80	—	—	ns
Data Hold Time	$t_{DH}$	40	—	—	ns
Access Time	$t_{ACC}$	—	—	150	ns
Output Hold Time	$t_{OH}$	10	—	50	ns

**Conditions:**  $T_a = -20^{\circ}\text{C}$  to  $75^{\circ}\text{C}$ ,  $V_{SS} = 0\text{V}$ ,  $V_{DD} = 5.0 \pm 0.5\text{V}$

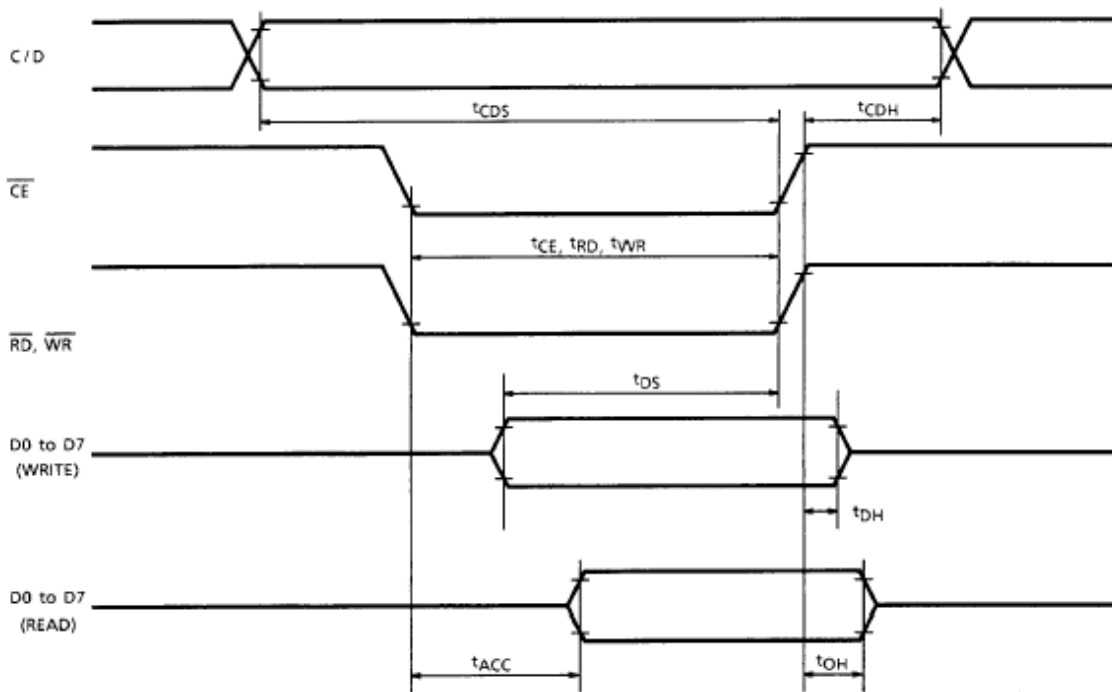

Figure 4: Timing Waveform

# Specifications

## Electrical

Table 6: Electrical Characteristics

Item	Symbol	Min	Typ	Max	Unit
Supply Voltage For Logic	$V_{DD}$	2.7	3.3	5.0	V
Supply Voltage For LCD (Contrast)	$V_0$	-8.8	-7.7	-5.8	V
Input High Voltage	$V_{IH}$	$0.7 V_{DD}$	—	$V_{DD}$	V
Input Low Voltage	$V_{IL}$	$V_{SS}$	—	$0.3 V_{DD}$	V
Supply Current ( $V_{DD}=3.3V$ )	$I_{DD}$	—	23.0	28.0	mA
Supply Voltage of Green and Blue Backlights (4 Die)	$V_{LED}$	2.9	3.1	3.3	V
Supply Current of Green and Blue Backlights (4 Die)	$I_{LED}$	0	—	60	mA
Supply Voltage of Red Backlight (4 Die)	$V_{LED}$	1.9	2.1	2.3	V
Supply Current of Red Backlight (4 Die)	$I_{LED}$	0	—	40	mA

## Optical

Table 7: Display Characteristics

Item	Dimension	Unit
Number of Pixels	240 Columns x 64 Rows	—
Module dimension	112.0 x 38.0 x 31.0	mm
View area	98.0 x 28.4	mm
Active area	93.67 x 24.93	mm
Dot size	0.36 x 0.36	mm
Dot pitch	0.39 x 0.39	mm
Duty	1/64	
View direction	12 o'clock	

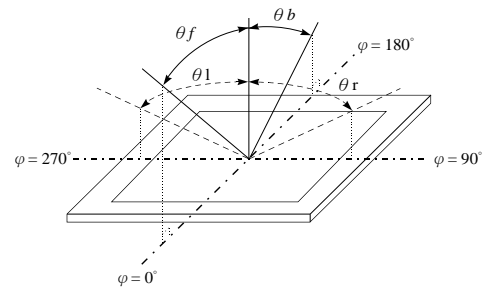

Figure 5: Viewing Angle Definition

Table 8: Viewing Characteristics

Item	Symbol	Min	Typ	Max	Unit
View Angle	(V) $\theta$	-20	—	35	deg
	(H) $\phi$	-30	—	30	deg
Contrast Ratio	CR	—	3	—	—
Response Time	T rise	—	—	250	ms
	T fall	—	—	250	ms

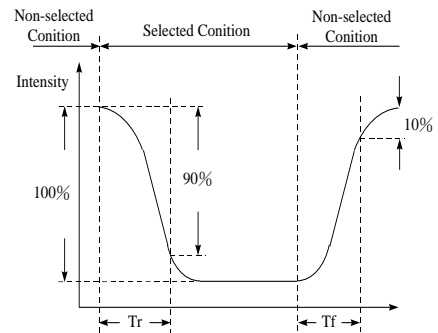

Figure 6: Display Response Time

## Environmental

Table 9: Environmental Specifications

Item	Symbol	Min	Max	Unit
Operating Temp.	Top	-20	70	°C
Storage Temp.	Tstr	-30	80	°C

**Note:** Maximum 90% non-condensing humidity.



# Troubleshooting

## Power

For your MOP Display to function correctly, appropriate power must be applied, often as indicated by the backlight illuminating or a darkening of the character spaces. Please refer to the power diagram below and reference all voltages to the specifications provided.

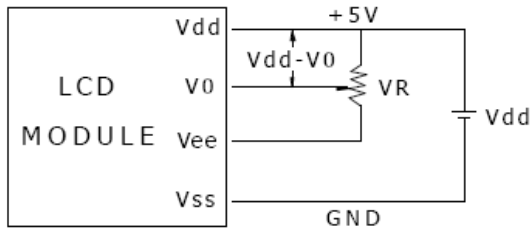

Vdd-V0: LCD Driving Voltage  
VR: 10K - 20K

Figure 7: Single Supply Configuration

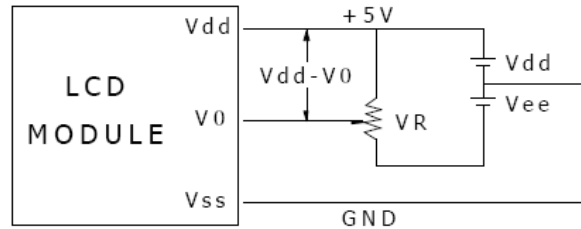

Vdd-V0: LCD Driving Voltage  
VR: 10K - 20K

Figure 8: Dual Supply Configuration

## Display

If your display is powered successfully, the backlight or contrast should be evident. A lack of text could be the result of a high contrast voltage, lower  $V_0$ .

## Communication

When communication of either text or commands is interrupted, check all data and control pins for continuity. Finally, slow down communication and refer to timing diagrams and specifications for proper control flow.

## Precautions

- Do not make extra holes in the display, modify its shape, or change the components.
- Avoid applying excessive electrical or mechanical shock to the module.
- Do not drop, bend, twist, or disassemble the display.
- Avoid operation outside absolute maximum ratings.
- Solder only to the I/O terminals provide, ensuring proper grounding.
- Store in an anti-static container within a clean environment, clean carefully if necessary.

## Ordering

### Part Numbering Scheme

Table 10: Parallel Part Numbering Scheme

<b>MOP</b>	<b>G</b>	<b>L</b>	<b>240</b>	<b>64</b>	<b>R</b>	<b>B</b>	<b>S</b>	<b>S</b>	<b>X</b>	<b>2</b>	<b>2</b>	<b>N</b>	<b>3</b>	<b>I</b>	<b>N</b>
1	2	3	4	5	6	7	8	9	10	11	12	13	14	15	16

### Options

Table 11: Parallel Part Options

#	Designator	Options
1	Product Line	MOP: Matrix Orbital Parallel Display
2	Display Type	G: Graphic
3	Screen Type	L: Liquid Crystal Display
4	Display Columns	122: One Hundred Twenty-Two Pixel Columns 240: Two Hundred Forty Pixel Columns
5	Display Rows	32: Thirty-Two Pixel Rows 64: Sixty-Four Pixel Rows 128: One Hundred Twenty-Eight Pixel Rows
6	Display Form Factor	A: A Form Factor B: B Form Factor D: D Form Factor R: R Form Factor
7	IC Package	B: Chip on Board
8	LCD Glass Type	B: STN Positive Blue G: STN Positive Grey S: Special W: FSTN Positive Y: STN Positive Yellow
9	Polarizer Style	F: Transflective S: Special T: Transmissive
10	Backlight Colour	X: Inverse Tricolour Y: Yellow-Green W: White
11	Viewing Angle	1: 6:00 2: 12:00
12	Controller	2: T6963 Compatible 6: SED 1520 Compatible
13	Character Set	N: None
14	Input Voltage	3: 5.0V
15	Temperature Range	I: Industrial S: Standard
16	Negative Voltage Generation	N: None Provided Y: Negative Voltage Output Provided

## Contact

### Sales

Phone: 403.229.2737

Email: [sales@matrixorbital.ca](mailto:sales@matrixorbital.ca)

### Support

Phone: 403.204.3750

Email: [support@matrixorbital.ca](mailto:support@matrixorbital.ca)

### Online

Purchasing: [www.matrixorbital.com](http://www.matrixorbital.com)

Support: [www.matrixorbital.ca](http://www.matrixorbital.ca)