



## STGB6NC60H

N-channel 600V - 7A - D<sup>2</sup>PAK  
Very fast PowerMESH™ IGBT

### General features

Type	V <sub>CES</sub>	V <sub>CE(sat)</sub> max @25°C	I <sub>C</sub> @100°C
STGB6NC60H	600V	<2.5V	7A

- Low on voltage drop (V<sub>cesat</sub>)
- Low C<sub>RES</sub> / C<sub>IES</sub> ratio (no cross-conduction susceptibility)
- Very soft ultra fast recovery antiparallel diode
- High frequency operation

### Description

Using the latest high voltage technology based on a patented strip layout, STMicroelectronics has designed an advanced family of IGBTs, the PowerMESH™ IGBTs, with outstanding performances. The suffix "H" identifies a family optimized for high frequency application in order to achieve very high switching performances (reduced t<sub>fall</sub>) maintaining a low voltage drop.

### Applications

- High frequency inverters
- SMPS and PFC in both hard switch and resonant topologies
- Motor drivers

### Order codes

Part number	Marking	Package	Packaging
STGB6NC60HT4	GB6NC60H	D <sup>2</sup> PAK	Tape & reel

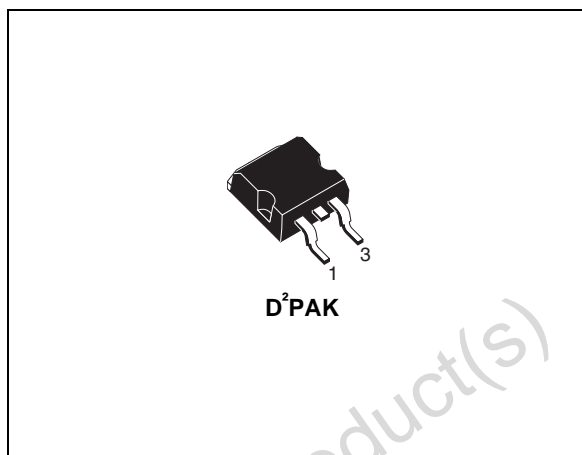

### Internal schematic diagram

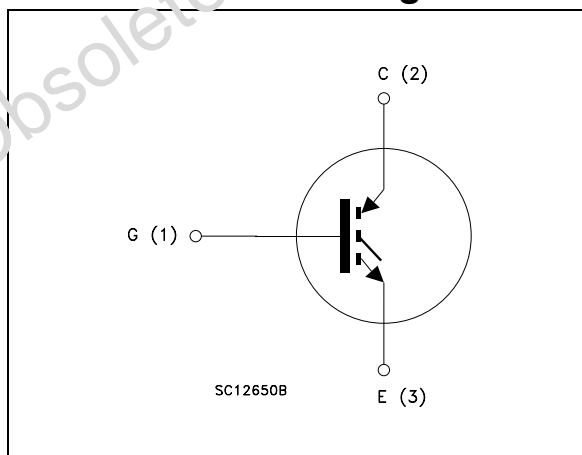

# Contents

<b>1</b>	<b>Electrical ratings</b> .....	<b>3</b>
<b>2</b>	<b>Electrical characteristics</b> .....	<b>4</b>
2.1	Electrical characteristics (curves) .....	6
<b>3</b>	<b>Test circuit</b> .....	<b>9</b>
<b>4</b>	<b>Package mechanical data</b> .....	<b>10</b>
<b>5</b>	<b>Packaging mechanical data</b> .....	<b>12</b>
<b>6</b>	<b>Revision history</b> .....	<b>13</b>

Obsolete Product(s) - Obsolete Product(s)

# 1 Electrical ratings

**Table 1. Absolute maximum ratings**

Symbol	Parameter	Value	Unit
$V_{CES}$	Collector-emitter voltage ( $V_{GS} = 0$ )	600	V
$I_C^{(1)}$	Collector current (continuous) at $T_C = 25^\circ\text{C}$	15	A
$I_C^{(1)}$	Collector current (continuous) at $T_C = 100^\circ\text{C}$	7	A
$I_{CM}^{(2)}$	Collector current (pulsed)	21	A
$V_{GE}$	Gate-emitter voltage	$\pm 20$	V
$P_{TOT}$	Total dissipation at $T_C = 25^\circ\text{C}$	56	W
$T_{stg}$	Storage temperature	- 55 to 150	°C
$T_j$	Operating junction temperature		
$T_l$	Maximum lead temperature for soldering purpose (for 10sec. 1.6 mm from case)	300	°C

1. Calculated according to the iterative formula::

$$I_C(T_C) = \frac{T_{JMAX} - T_C}{R_{THJ-C} \times V_{CESAT(MAX)}(T_C - T_C)}$$

2. Pulse width limited by max junction temperature

**Table 2. Thermal resistance**

Symbol	Parameter	Value	Unit
Rthj-case	Thermal resistance junction-case max	2	°C/W
Rthj-amb	Thermal resistance junction-ambient max	62.5	°C/W

## 2 Electrical characteristics

( $T_{CASE}=25^{\circ}C$  unless otherwise specified)

**Table 3. Static**

Symbol	Parameter	Test conditions	Min.	Typ.	Max.	Unit
$V_{BR(CES)}$	Collector-emitter breakdown voltage	$I_C = 1\text{mA}, V_{GE} = 0$	600			V
$V_{CE(sat)}$	Collector-emitter saturation voltage	$V_{GE} = 15\text{V}, I_C = 3\text{A}$ $V_{GE} = 15\text{V}, I_C = 3\text{A}, T_C = 125^{\circ}C$		1.9 1.7	2.5	V V
$V_{GE(th)}$	Gate threshold voltage	$V_{CE} = V_{GE}, I_C = 250\ \mu\text{A}$	3.75		5.75	V
$I_{CES}$	Collector cut-off current ( $V_{GE} = 0$ )	$V_{CE} = \text{Max rating}, T_C = 25^{\circ}C$ $V_{CE} = \text{Max rating}, T_C = 125^{\circ}C$			10 1	$\mu\text{A}$ mA
$I_{GES}$	Gate-emitter leakage current ( $V_{CE} = 0$ )	$V_{GE} = \pm 20\text{V}, V_{CE} = 0$			$\pm 100$	nA
$g_{fs}$	Forward transconductance	$V_{CE} = 15\text{V}, I_C = 3\text{A}$		3		S

**Table 4. Dynamic**

Symbol	Parameter	Test conditions	Min.	Typ.	Max.	Unit
$C_{ies}$	Input capacitance	$V_{CE} = 25\text{V}, f = 1\text{MHz},$ $V_{GE} = 0$		205		pF
$C_{oes}$	Output capacitance			32		pF
$C_{res}$	Reverse transfer capacitance			5.5		pF
$Q_g$	Total gate charge	$V_{CE} = 390\text{V}, I_C = 3\text{A},$ $V_{GE} = 15\text{V},$ <i>(see Figure 16)</i>		13.6		nC
$Q_{ge}$	Gate-emitter charge			3.4		nC
$Q_{gc}$	Gate-collector charge			5.1		nC
$I_{CL}$	Turn-off SOA minimum current	$V_{clamp} = 390\text{V}, T_J = 150^{\circ}C,$ $R_G = 10\ \Omega, V_{GE} = 15\text{V}$		19		A

**Table 5. Switching on/off (inductive load)**

Symbol	Parameter	Test conditions	Min.	Typ.	Max.	Unit
$t_{d(on)}$	Turn-on delay time	$V_{CC} = 390V, I_C = 3A$		12		ns
$t_r$	Current rise time	$R_G = 10\Omega, V_{GE} = 15V,$		5		ns
$(di/dt)_{on}$	Turn-on current slope	$T_j = 25^\circ C$ (see Figure 17)		612		A/ $\mu s$
$t_{d(on)}$	Turn-on delay time	$V_{CC} = 390V, I_C = 3A$		13		ns
$t_r$	Current rise time	$R_G = 10\Omega, V_{GE} = 15V,$		4.3		ns
$(di/dt)_{on}$	Turn-on current slope	$T_j = 125^\circ C$ (see Figure 17)		560		A/ $\mu s$
$t_r(V_{off})$	Off voltage rise time	$V_{CC} = 390V, I_C = 3A,$		40		ns
$t_{d(off)}$	Turn-off delay time	$R_{GE} = 10\Omega, V_{GE} = 15V,$		76		ns
$t_f$	Current fall time	$T_j = 25^\circ C$ (see Figure 17)		100		ns
$t_r(V_{off})$	Off voltage rise time	$V_{CC} = 390V, I_C = 3A,$		60		ns
$t_{d(off)}$	Turn-off delay time	$R_{GE} = 10\Omega, V_{GE} = 15V,$		98		ns
$t_f$	Current fall time	$T_j = 125^\circ C$ (see Figure 17)		124		ns

**Table 6. Switching energy (inductive load)**

Symbol	Parameter	Test conditions	Min.	Typ.	Max.	Unit
$E_{on}^{(1)}$	Turn-on switching losses	$V_{CC} = 390V, I_C = 3A$		20		$\mu J$
$E_{off}^{(2)}$	Turn-off switching losses	$R_G = 10\Omega, V_{GE} = 15V,$		68		$\mu J$
$E_{ts}$	Total switching losses	$T_j = 25^\circ C$ (see Figure 17)		88		$\mu J$
$E_{on}^{(1)}$	Turn-on switching losses	$V_{CC} = 390V, I_C = 3A$		37		$\mu J$
$E_{off}^{(2)}$	Turn-off switching losses	$R_G = 10\Omega, V_{GE} = 15V,$		93		$\mu J$
$E_{ts}$	Total switching losses	$T_j = 125^\circ C$ (see Figure 17)		130		$\mu J$

1.  $E_{on}$  is the turn-on losses when a typical diode is used in the test circuit in figure 17. If the IGBT is offered in a package with a co-pak diode, the co-pak diode is used as external diode. IGBTs & Diode are at the same temperature (25°C and 125°C)
2. Turn-off losses include also the tail of the collector current

## 2.1 Electrical characteristics (curves)

Figure 1. Output characteristics

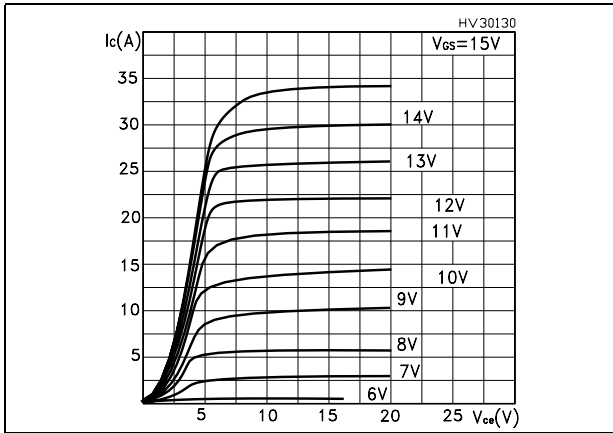

Figure 2. Transfer characteristics

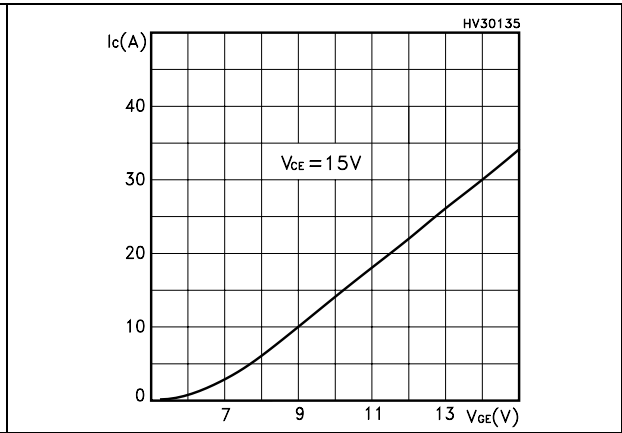

Figure 3. Transconductance

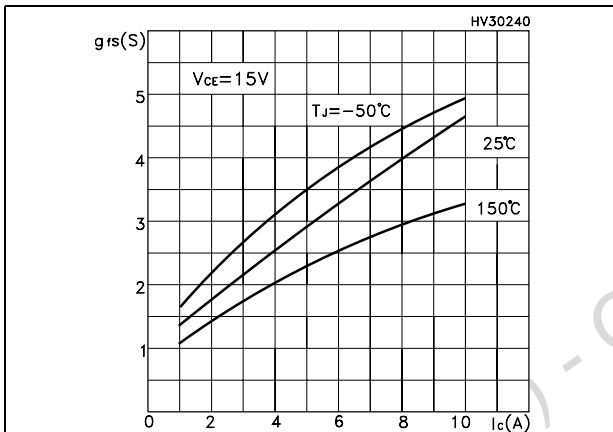

Figure 4. Collector-emitter on voltage vs temperature

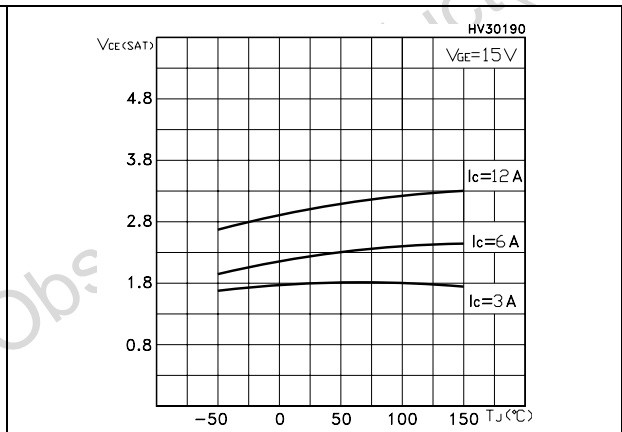

Figure 5. Gate charge vs gate-source voltage

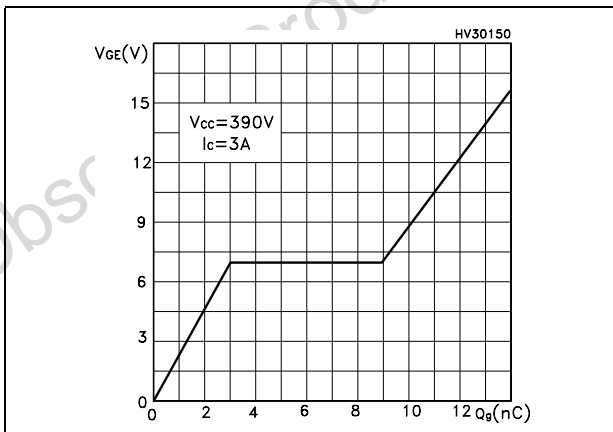

Figure 6. Capacitance variations

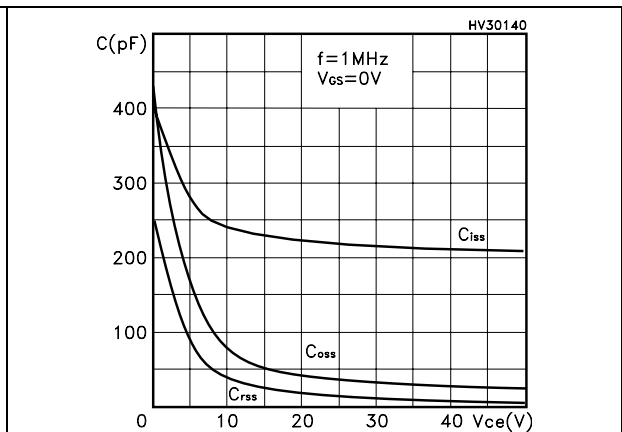

Figure 7. Normalized gate threshold voltage vs temperature

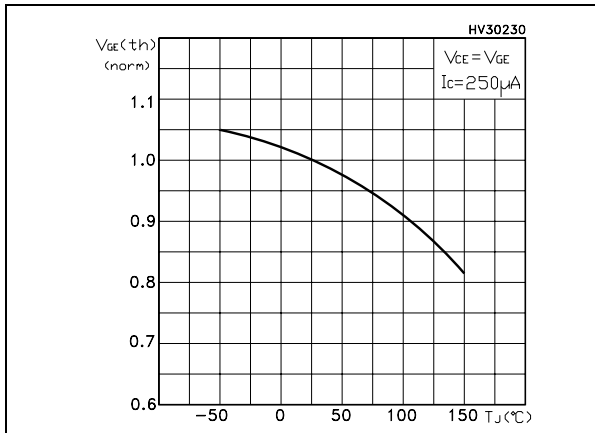

Figure 8. Collector-emitter on voltage vs collector current

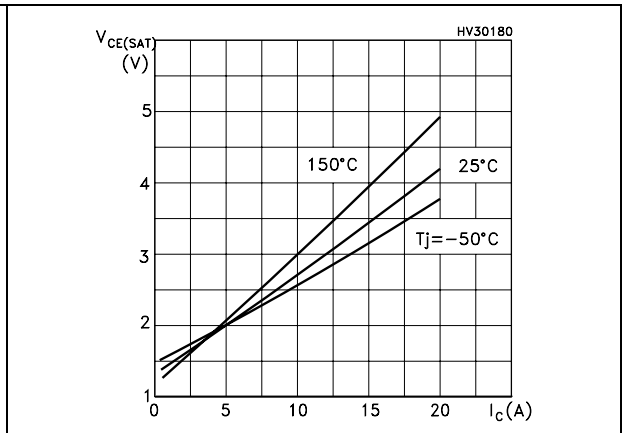

Figure 9. Normalized breakdown voltage vs temperature

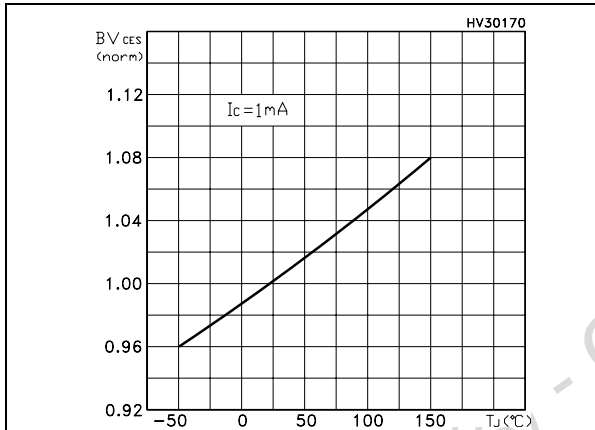

Figure 10. Switching losses vs temperature

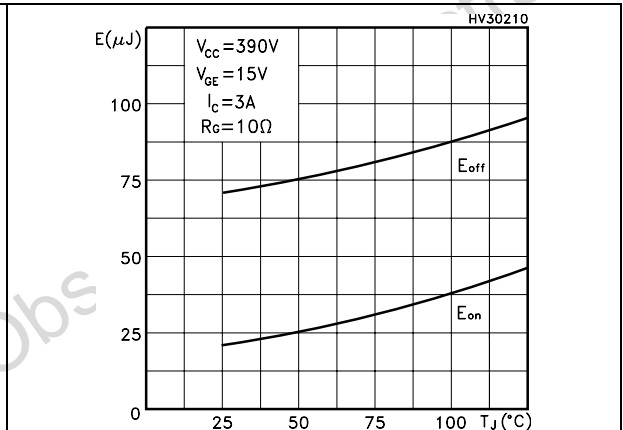

Figure 11. Switching losses vs gate resistance

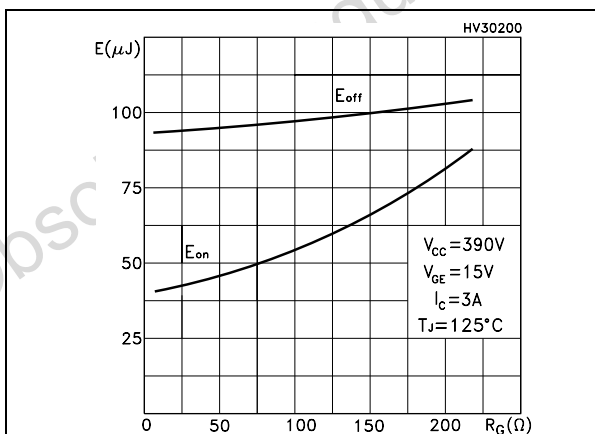

Figure 12. Switching losses vs collector current

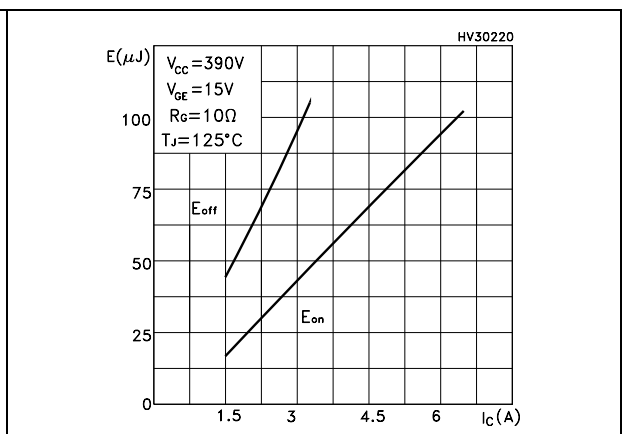

Figure 13. Thermal impedance

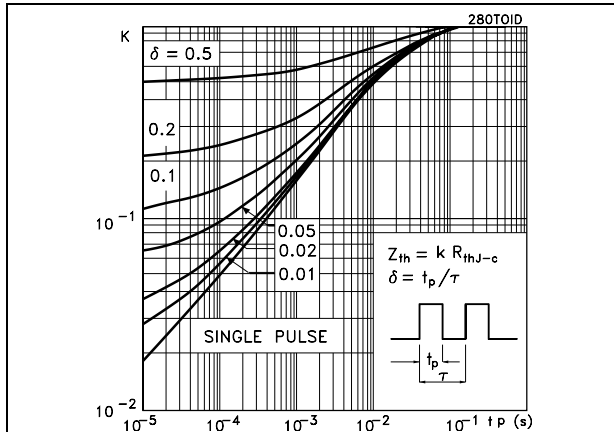
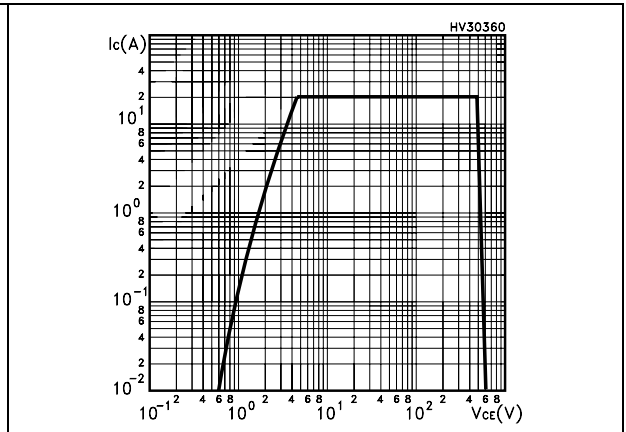

Figure 14. Turn-off SOA



Obsolete Product(s) - Obsolete Product(s)



### 3 Test circuit

Figure 15. Test circuit for inductive load switching

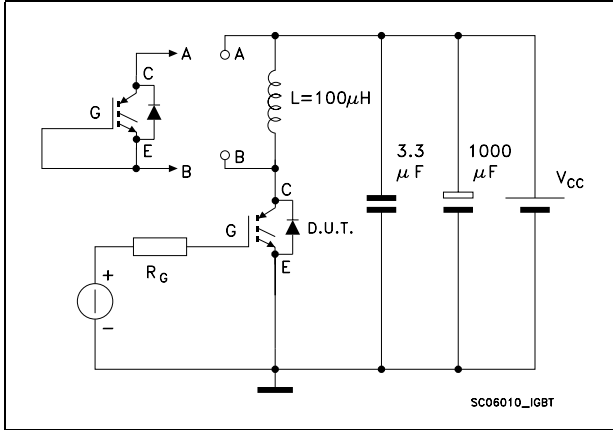

Figure 17. Switching waveform

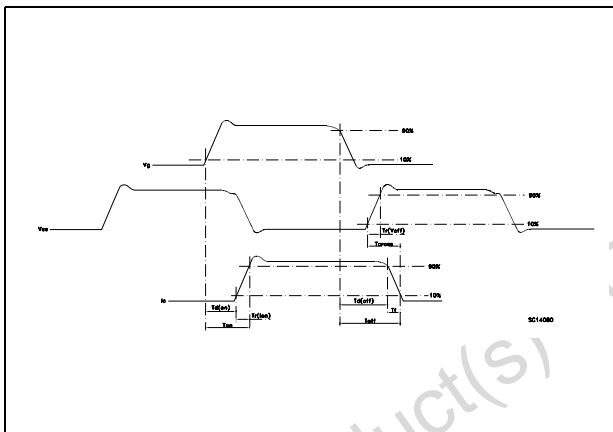

Figure 16. Gate charge test circuit

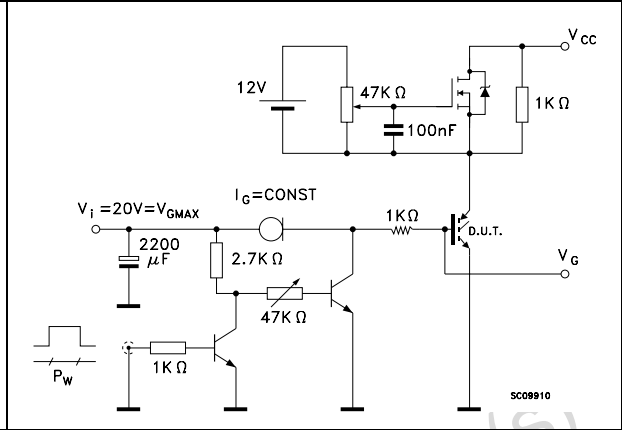
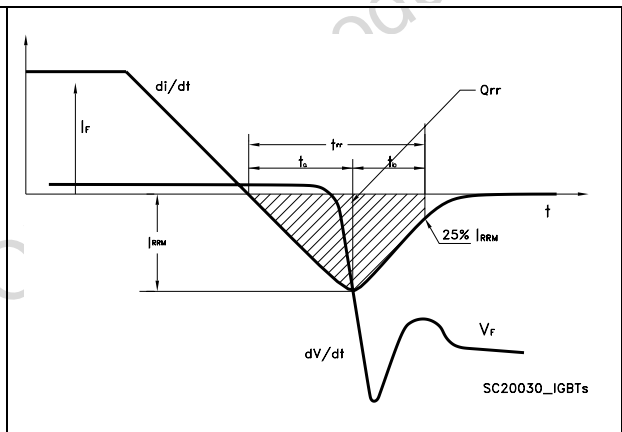

Figure 18. Diode recovery time waveform



Obsolete Product(s)

## 4 Package mechanical data

In order to meet environmental requirements, ST offers these devices in ECOPACK® packages. These packages have a Lead-free second level interconnect . The category of second level interconnect is marked on the package and on the inner box label, in compliance with JEDEC Standard JESD97. The maximum ratings related to soldering conditions are also marked on the inner box label. ECOPACK is an ST trademark. ECOPACK specifications are available at: [www.st.com](http://www.st.com)

Obsolete Product(s) - Obsolete Product(s)

**D<sup>2</sup>PAK MECHANICAL DATA**

DIM.	mm.			inch		
	MIN.	TYP.	MAX.	MIN.	TYP.	MAX.
A	4.4		4.6	0.173		0.181
A1	2.49		2.69	0.098		0.106
A2	0.03		0.23	0.001		0.009
B	0.7		0.93	0.027		0.036
B2	1.14		1.7	0.044		0.067
C	0.45		0.6	0.017		0.023
C2	1.23		1.36	0.048		0.053
D	8.95		9.35	0.352		0.368
D1		8			0.315	
E	10		10.4	0.393		
E1		8.5			0.334	
G	4.88		5.28	0.192		0.208
L	15		15.85	0.590		0.625
L2	1.27		1.4	0.050		0.055
L3	1.4		1.75	0.055		0.068
M	2.4		3.2	0.094		0.126
R		0.4			0.015	
V2	0°		4°			

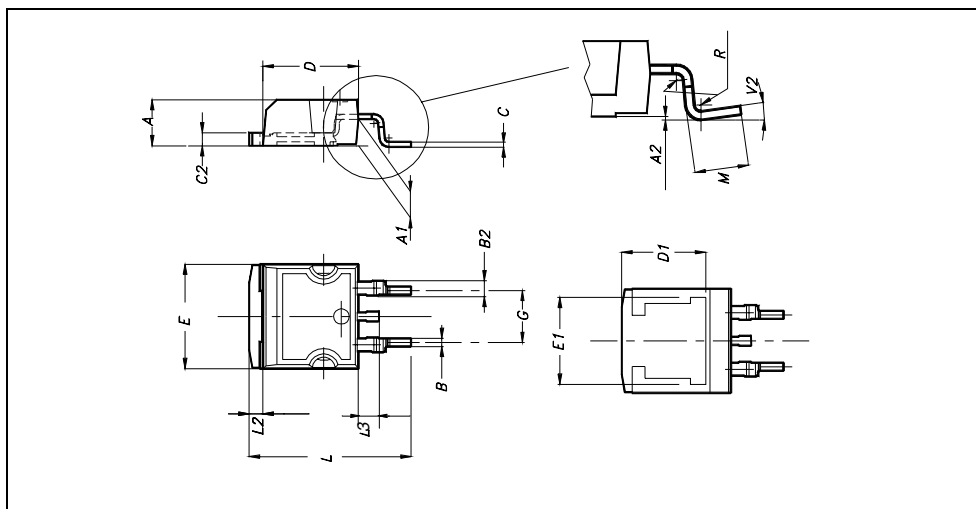

# 5 Packaging mechanical data

## D<sup>2</sup>PAK FOOTPRINT



## TAPE AND REEL SHIPMENT

**TAPE MECHANICAL DATA**

DIM.	mm		inch	
	MIN.	MAX.	MIN.	MAX.
A0	10.5	10.7	0.413	0.421
B0	15.7	15.9	0.618	0.626
D	1.5	1.6	0.059	0.063
D1	1.59	1.61	0.062	0.063
E	1.65	1.85	0.065	0.073
F	11.4	11.6	0.449	0.456
K0	4.8	5.0	0.189	0.197
P0	3.9	4.1	0.153	0.161
P1	11.9	12.1	0.468	0.476
P2	1.9	2.1	0.075	0.082
R	50		1.574	
T	0.25	0.35	0.0098	0.0137
W	23.7	24.3	0.933	0.956

**REEL MECHANICAL DATA**

DIM.	mm		inch	
	MIN.	MAX.	MIN.	MAX.
A		330		12.992
B	1.5		0.059	
C	12.8	13.2	0.504	0.520
D	20.2		0.795	
G	24.4	26.4	0.960	1.039
N	100		3.937	
T		30.4		1.197

BASE QTY	BULK QTY
1000	1000

10 pitches cumulative tolerance on tape +/- 0.2 mm

Center line of cavity

User Direction of Feed

FEED DIRECTION

TRL

Bending radius R min.

\* on sales type

## 6 Revision history

Table 7. Revision history

Date	Revision	Changes
18-Nov-2005	1	First Release
27-jul-2006	2	New template

Obsolete Product(s) - Obsolete Product(s)

**Please Read Carefully:**

Information in this document is provided solely in connection with ST products. STMicroelectronics NV and its subsidiaries ("ST") reserve the right to make changes, corrections, modifications or improvements, to this document, and the products and services described herein at any time, without notice.

All ST products are sold pursuant to ST's terms and conditions of sale.

Purchasers are solely responsible for the choice, selection and use of the ST products and services described herein, and ST assumes no liability whatsoever relating to the choice, selection or use of the ST products and services described herein.

No license, express or implied, by estoppel or otherwise, to any intellectual property rights is granted under this document. If any part of this document refers to any third party products or services it shall not be deemed a license grant by ST for the use of such third party products or services, or any intellectual property contained therein or considered as a warranty covering the use in any manner whatsoever of such third party products or services or any intellectual property contained therein.

**UNLESS OTHERWISE SET FORTH IN ST'S TERMS AND CONDITIONS OF SALE ST DISCLAIMS ANY EXPRESS OR IMPLIED WARRANTY WITH RESPECT TO THE USE AND/OR SALE OF ST PRODUCTS INCLUDING WITHOUT LIMITATION IMPLIED WARRANTIES OF MERCHANTABILITY, FITNESS FOR A PARTICULAR PURPOSE (AND THEIR EQUIVALENTS UNDER THE LAWS OF ANY JURISDICTION), OR INFRINGEMENT OF ANY PATENT, COPYRIGHT OR OTHER INTELLECTUAL PROPERTY RIGHT.**

**UNLESS EXPRESSLY APPROVED IN WRITING BY AN AUTHORIZED ST REPRESENTATIVE, ST PRODUCTS ARE NOT RECOMMENDED, AUTHORIZED OR WARRANTED FOR USE IN MILITARY, AIR CRAFT, SPACE, LIFE SAVING, OR LIFE SUSTAINING APPLICATIONS, NOR IN PRODUCTS OR SYSTEMS WHERE FAILURE OR MALFUNCTION MAY RESULT IN PERSONAL INJURY, DEATH, OR SEVERE PROPERTY OR ENVIRONMENTAL DAMAGE. ST PRODUCTS WHICH ARE NOT SPECIFIED AS "AUTOMOTIVE GRADE" MAY ONLY BE USED IN AUTOMOTIVE APPLICATIONS AT USER'S OWN RISK.**

Resale of ST products with provisions different from the statements and/or technical features set forth in this document shall immediately void any warranty granted by ST for the ST product or service described herein and shall not create or extend in any manner whatsoever, any liability of ST.

ST and the ST logo are trademarks or registered trademarks of ST in various countries.

Information in this document supersedes and replaces all information previously supplied.

The ST logo is a registered trademark of STMicroelectronics. All other names are the property of their respective owners.

© 2006 STMicroelectronics - All rights reserved

STMicroelectronics group of companies

Australia - Belgium - Brazil - Canada - China - Czech Republic - Finland - France - Germany - Hong Kong - India - Israel - Italy - Japan - Malaysia - Malta - Morocco - Singapore - Spain - Sweden - Switzerland - United Kingdom - United States of America

[www.st.com](http://www.st.com)