



# LED Display Product Data Sheet LTS-4801JR

Spec No.: DS30-2001-030

Effective Date: 09/15/2001

Revision: -

**LITE-ON DCC**

**RELEASE**

BNS-OD-FC001/A4

**FEATURES**

- \* 0.39-INCH (10.0-mm ) DIGIT HEIGHT.
- \* CONTINUOUS UNIFORM SEGMENTS.
- \* LOW POWER REQUIREMENT.
- \* EXCELLENT CHARACTERS APPEARANCE.
- \* HIGH BRIGHTNESS & HIGH CONTRAST.
- \* WIDE VIEWING ANGLE.
- \* SOLID STATE RELIABILITY.
- \* CATEGORIZED FOR LUMINOUS INTENSITY.

**DESCRIPTION**

The LTS-4801JR is a 0.39-inch (10.0-mm) height single digit seven-segment display. This device utilizes AlInGaP super red LED chips, which are made from AlInGaP on GaAs substrate, and has a gray face and white segments.

**DEVICE**

<b>PART NO.</b>	<b>DESCRIPTION</b>
<b>AllnGaP Super RED</b>	<b>Common Anode</b>
<b>LTS-4801JR</b>	<b>Rt. Hand Decimal</b>

## PACKAGE DIMENSIONS

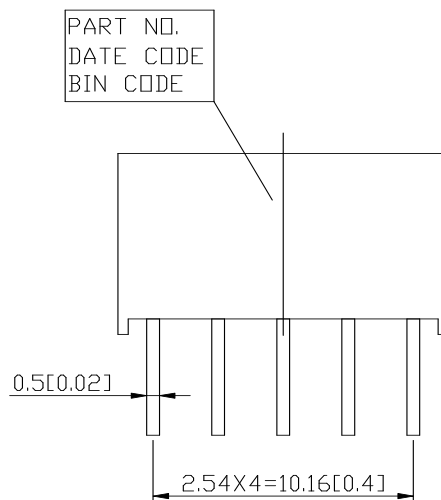
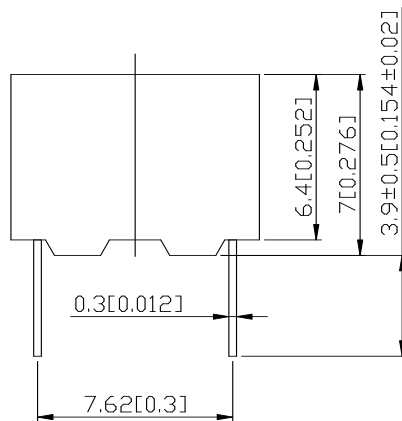
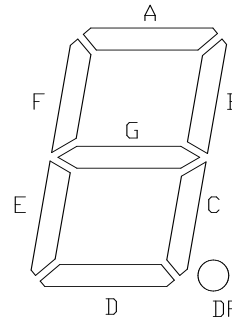
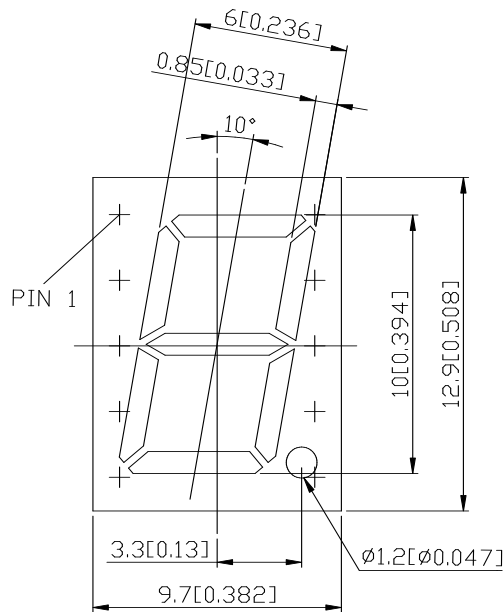

NOTES: All dimensions are in millimeters. Tolerances are  $\pm 0.25\text{mm}(0.01\text{'})$  unless otherwise noted.

## INTERNAL CIRCUIT DIAGRAM

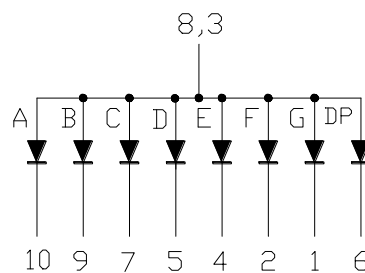

**PIN CONNECTION**

<b>No</b>	<b>CONNECTION</b>
1	CATHODE G
2	CATHODE F
3	COMMON ANODE
4	CATHODE E
5	CATHODE D
6	CATHODE D.P.
7	CATHODE C
8	COMMON ANODE
9	CATHODE B
10	CATHODE A

NOTE: PIN 3 & 8 ARE INTERNALLY CONNECTED.

**ABSOLUTE MAXIMUM RATING AT Ta=25°C**

PARAMETER	MAXIMUM RATING	UNIT
Power Dissipation Per Segment	70	mW
Peak Forward Current Per Segment (1/10 Duty Cycle, 0.1ms Pulse Width )	90	mA
Continuous Forward Current Per Segment	25	mA
Derating Linear From 25°C Per Segment	0.33	mA/°C
Reverse Voltage Per Segment	5	V
Operating Temperature Range	-35°C to +85°C	
Storage Temperature Range	-35°C to +85°C	
Solder Temperature 1/16 inch Below Seating Plane for 3 Seconds at 260°C		

**ELECTRICAL / OPTICAL CHARACTERISTICS AT Ta=25°C**

PARAMETER	SYMBOL	MIN.	TYP.	MAX.	UNIT	TEST CONDITION
Average Luminous Intensity	I <sub>v</sub>	200	520		μcd	I <sub>F</sub> =1mA
Peak Emission Wavelength	λ <sub>p</sub>		639		nm	I <sub>F</sub> =20mA
Spectral Line Half-Width	Δλ		20		nm	I <sub>F</sub> =20mA
Dominant Wavelength	λ <sub>d</sub>		631		nm	I <sub>F</sub> =20mA
Forward Voltage. Per Segment	V <sub>F</sub>		2.0	2.6	V	I <sub>F</sub> =20mA
Reverse Current, Per Segment	I <sub>R</sub>			100	μA	V <sub>R</sub> =5V
Luminous Intensity Matching Ratio	I <sub>v</sub> -m			2:1		I <sub>F</sub> =1mA

Note: Luminous intensity is measured with a light sensor and filter combination that approximates the CIE ( Commission Internationale De L'Eclairage ) eye-response curve.

**TYPICAL ELECTRICAL / OPTICAL CHARACTERISTIC CURVES**

(25°C Ambient Temperature Unless Otherwise Noted )

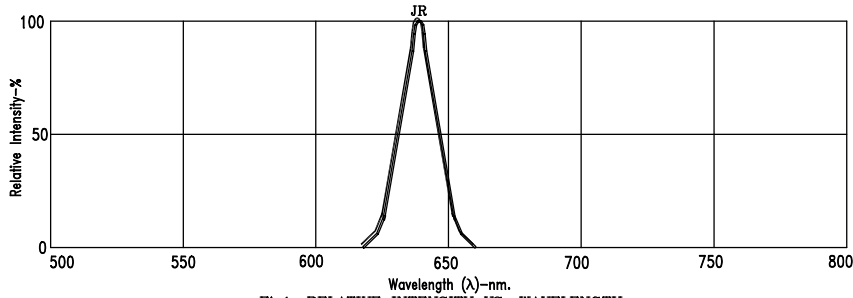

Fig1. RELATIVE INTENSITY VS. WAVELENGTH

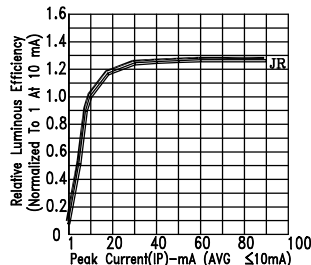

Fig2. RELATIVE LUMINOUS EFFICIENCY (LUMINOUS INTENSITY PER UNIT CURRENT) VS. PEAK CURRENT

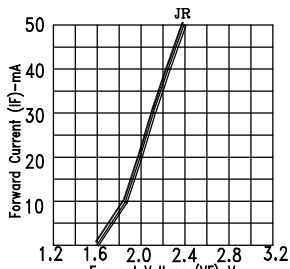

Fig3. FORWARD CURRENT VS. FORWARD VOLTAGE

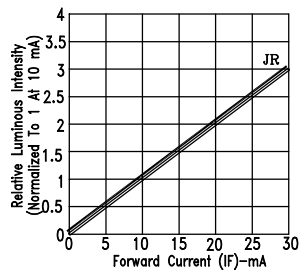

Fig4. RELATIVE LUMINOUS INTENSITY VS. FORWARD CURRENT

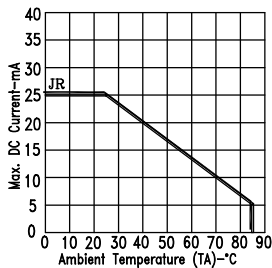

Fig5. MAX. ALLOWABLE DC CURRENT VS. AMBIENT TEMPERATURE.

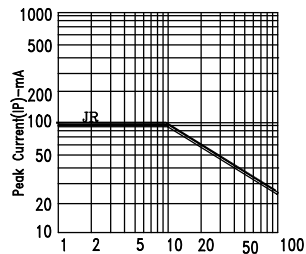

Fig6. MAX. PEAK CURRENT VS. DUTY CYCLE % (REFRESH RATE 1KHz)

NOTE : JR=AlInGaP SUPER RED