

IEC Appliance Inlet C20 with Filter, Line Switch 2-pole

Standard- or Medical-Filter



V-Lock



Description

- Panel Mount :
Screw-on mounting from front side
- 3 Functions :
Appliance Inlet Protection class I , Line Switch 2-pole , Line filter in standard and medical version
- Quick connect terminals 6.3 x 0.8 mm

Approvals

- VDE Certificate Number: 40001522
- UL File Number: E72928

Characteristics

- All single elements are already wired
- Line switch non-illuminated
- With EMC-shield
- Ideal for application with high transient loads
- Suitable for use in equipment according to IEC/UL 60950
- Suitable for use in medical equipment according to IEC/UL 60601-1

Other versions on request

- Line switch, illuminated
- Line switch with other rocker marking
- Variant with notch for V-Lock mating Cordsets

References

Alternative: version without line filter [EC11](#)
Alternative: Standard version

Weblinks

[pdf datasheet](#), [html-datasheet](#), [General Product Information](#), [RoHS](#), [CHINA-RoHS](#), [REACH](#), [Distributor-Stock-Check](#), [Accessories](#), [Detailed request for product](#)

Newly available variants corresponding to V-Lock mating cordset. The connector is equipped with a notch intended for use with the latching cordset. The cord latching system prevents against accidental removal of the cordset.

Technical Data

Ratings IEC	12 - 16A @ Ta 40 °C / 250VAC; 50Hz	appliance inlet/-outlet	C20 acc. to IEC 60320-1, UL 498, CSA C22.2 no. 42 (for cold conditions) pin-temperature 70 °C, 16A, Protection Class I
Ratings UL/CSA	12 - 20A @ Ta 40 °C / 125/250VAC; 60Hz	Line Switch	Rocker switch 2-pole, non-illuminated, acc. to IEC 61058-1 Technical Details
Leakage Current	standard < 0.5 mA (250 V / 60Hz) medical < 5 µA (250 V / 60 Hz)	Line Filter	Standard and Medical Version, IEC 60939, UL 1283, CSA C22.2 no. 8 Technical Details
Dielectric Strength	> 1.7kVDC between L-N > 2.7kVDC between L/N-PE Test voltage (2 sec)	MTBF	> 1'700'000h acc. to MIL-HB-217 F
Allowable Operation Temperature	-25 °C to 85 °C		
Climatic Category	25/085/21 acc. to IEC 60068-1		
IP-Protection	from front side IP 40 acc. to IEC 60529		
Protection Class	Suitable for appliances with protection class I acc. to IEC 61140		
Terminal	Quick connect terminals 6.3 x 0.8 mm		
Panel Thickness s	Screw: max 8 mm Mounting screw torque max 0.5Nm		
Material: Housing	Thermoplastic, black, UL 94V-0		

Detailed information on product approvals, code requirements, usage instructions and detailed test conditions can be looked up in [General Product Information](#)

Dimension

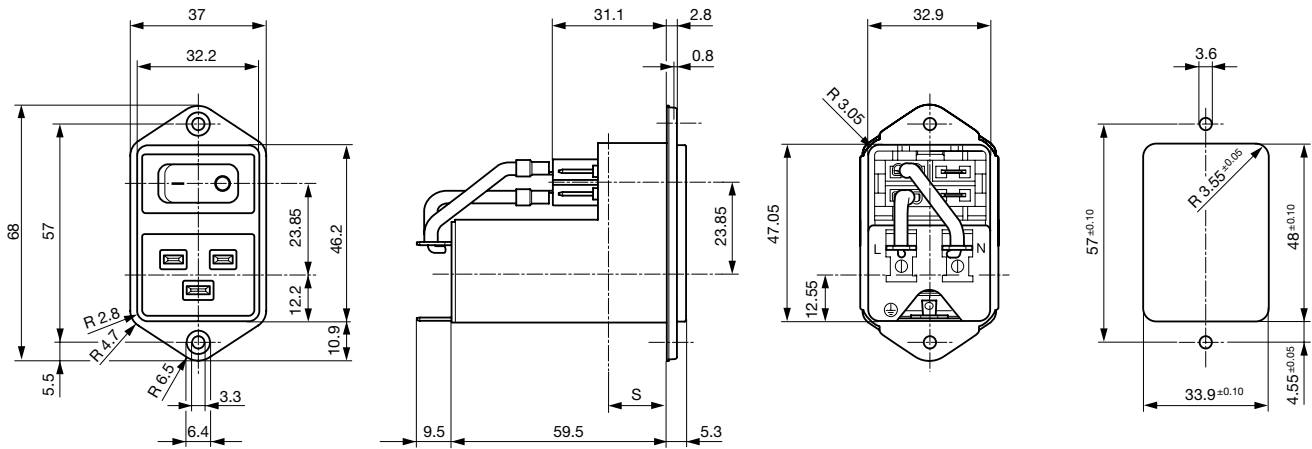

Technical Data of Filter-Components

Rated Current [A]	Filter-Type	Inductances L [mH]	Capacitance CX [nF]	Capacitance CY [nF]	R [MΩ]
12	Standard Version	2 x 0.8	100	2.2	1
16	Standard Version	2 x 0.6	100	2.2	1
20	Standard Version	2 x 0.3	100	2.2	1
12	Medical Version (M5)	2 x 0.8	100	-	1
16	Medical Version (M5)	2 x 0.6	100	-	1
20	Medical Version (M5)	2 x 0.3	100	-	1

Diagrams

Standard version

Medical version (M5)

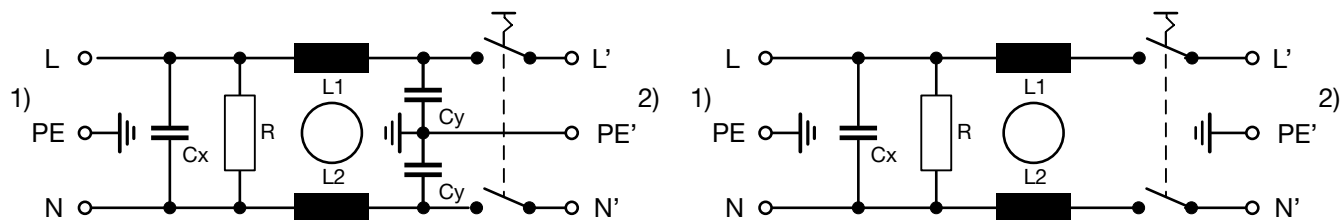

1) Line
2) Load

1) Line
2) Load

Attenuation Loss

--- 50Ω differential mode ____ 50Ω common mode

Standard version

12 A

16 A

20 A

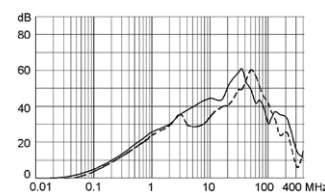
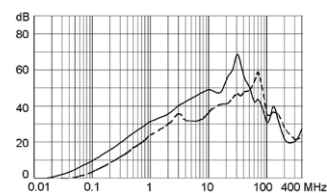
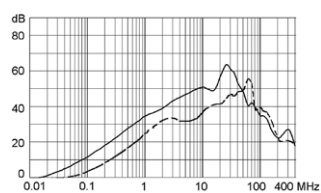

Medical version (M5)

12 A

16 A

20 A

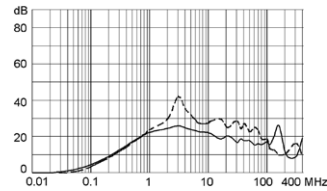
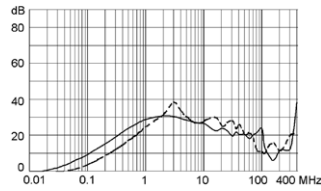
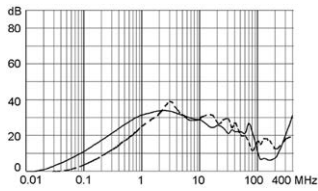

All Variants

Rated Current [A]	Filter-Type	Internally wired	Line Switch	V-Lock	Order Number
12	Standard Version	●	2-pole		EC12.3101.001
12	Standard Version	●	2-pole	●	EC12.3101.001.21
16	Standard Version	●	2-pole		EC12.2101.001
20	Standard Version	●	2-pole		EC12.1101.001
12	Standard Version		2-pole		EC12.3101.002
16	Standard Version		2-pole		EC12.2101.002
20	Standard Version		2-pole		EC12.1101.002
12	Medical Version (M5)	●	2-pole		EC12.3201.001
16	Medical Version (M5)	●	2-pole		EC12.2201.001
16	Medical Version (M5)	●	2-pole	●	EC12.2201.001.21
20	Medical Version (M5)	●	2-pole		EC12.1201.001
12	Medical Version (M5)		2-pole		EC12.3201.002
16	Medical Version (M5)		2-pole		EC12.2201.002
20	Medical Version (M5)		2-pole		EC12.1201.002

Most Popular.

Availability for all products can be searched real-time: <http://www.schurter.com/en/Stock-Check/Stock-Check-SCHURTER>

Packaging unit 20 Pcs

Accessories

Description



Wire Harness
Wire harness for SCHURTER products

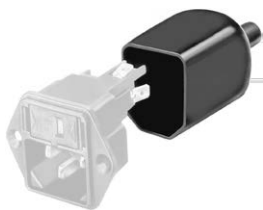

Assorted Covers
Rear Cover

0859.0108



[Cord retaining kits](#)
[Cord retaining strain relief](#)

Flat head, Z	0888.0021
Flat head, H	4700.0008

Mating Outlets/Connectors

Category / Description



[Connector Overview complete](#)

IEC Connector C19, Rewireable, Straight	4795
IEC Connector C19, Rewireable, Angled	4790
IEC Connector C19, Rewireable, Straight	0104U

[Connector further types to EC12](#)

Mating Outlets/Connectors shuttered



[Power Cord Overview complete](#)

Overview Power Cord with IEC Appliance Connector C19, V-Lock, straight	VAC19KS
--	---------

[Power Cord further types to EC12](#)