

## EMI Bead Cores

Type: **EXCEL**

**Discontinued**

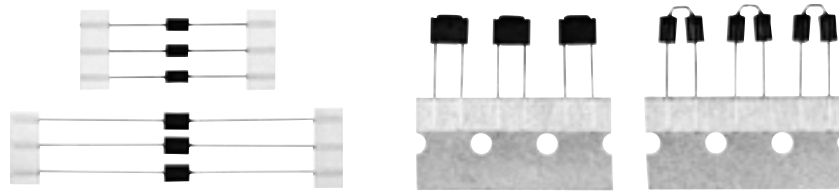

### ■ Features

- For reduction of high-frequency noise
- Low cost noise filter
- Axial and radial taped types are available for automatic insertion machines
- RoHS compliant

### ■ Recommended Applications

- Digital equipment such as PCs, word processors, printers, HDD, PPC, and communication equipment.
- Digital audio and video equipment.
- AC adapters, and switching power supplies.
- Electronic musical instruments, and other digital equipment.

### ■ Explanation of Part Numbers

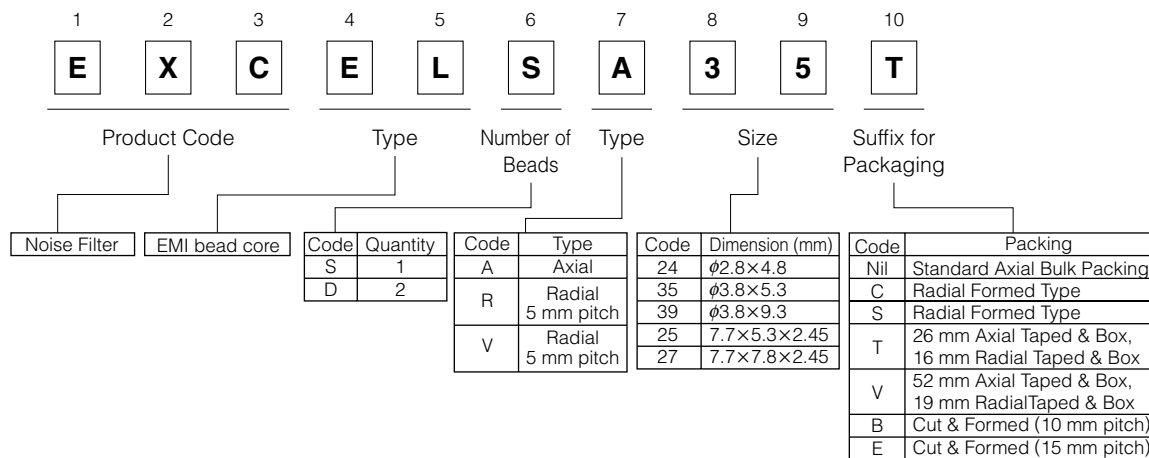

### ■ Packaging Methods

Part Number	Mass (Weight) [mg/pc.]	Standard Quantity
EXCELSA24	185	2000 pcs.
EXCELSA24B	145	2000 pcs.
EXCELSA24T	182	2000 pcs.
EXCELSA24V	238	2000 pcs.
EXCELSA35	378	1000 pcs.
EXCELSA35B	291	2000 pcs.
EXCELSA35T	323	1000 pcs.
EXCELSA35V	379	1000 pcs.
EXCELSA39	536	1000 pcs.
EXCELSA39E	457	2000 pcs.
EXCELSA39V	539	1000 pcs.
EXCELSR35S	317	2000 pcs.
EXCELSR35T	356	1000 pcs.
EXCELSV35S	307	2000 pcs.
EXCELSV35V	360	1000 pcs.
EXCELDLDR25C	428	2000 pcs.
EXCELDLDR25V	488	2000 pcs.
EXCELDLDR27C	637	2000 pcs.
EXCELDLDR27V	670	2000 pcs.
EXCELDLDR35C	546	2000 pcs.
EXCELDLDR35V	614	1000 pcs.

### ■ Ratings

Discontinued

Part Number	Impedance <sup>(1)</sup> (Ω)	DC Resistance (mΩ)	Insulation Resistance (MΩ)	Rated Current (A DC)	Category Temp. Range (°C)
EXCELSA24□	30 min.	10 max.	10 min.	7 max.	-25 to +85
EXCELSA35□	50 min.				
EXCELSA39□	80 min.				
EXCELSR35□	50 min.				
EXCELSV35□	50 min.				
EXCELDR25□	80 min.				
EXCELDR27□	160 min.				
EXCELDR35□	90 min.				

(1) Measurement Temperature: +20 °C, Measurement Frequency: 100 MHz

### ■ Dimensions in mm (not to scale)

- EXCELSA24
- EXCELSA35
- EXCELSA39

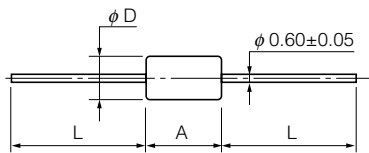

	ELSA24	ELSA35	ELSA39
D	φ2.8 max.	φ3.8 max.	φ3.8 max.
A	4.8 max.	5.3 max.	9.3 max.
L	10 min.	20 min.	18 min.

- EXCELSA24B
- EXCELSA35B
- EXCELSA39E

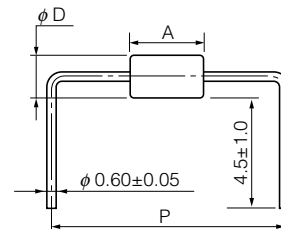

	ELSA24	ELSA35	ELSA39
D	φ2.8 max.	φ3.8 max.	φ3.8 max.
A	4.8 max.	5.3 max.	9.3 max.
L	10 min.	20 min.	18 min.

- EXCELDR25C
- EXCELDR27C

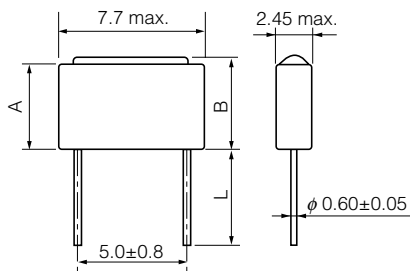

	ELDR25C	ELDR27C
A	5.3 max.	7.8 max.
B	7 max.	9.5 max.
L	4.5±1.0	8.0±1.0

- EXCELSR35S

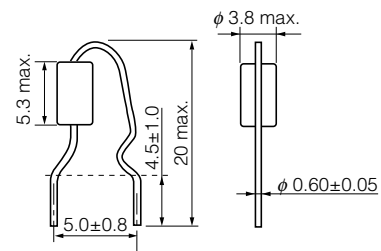

- EXCELSV35S

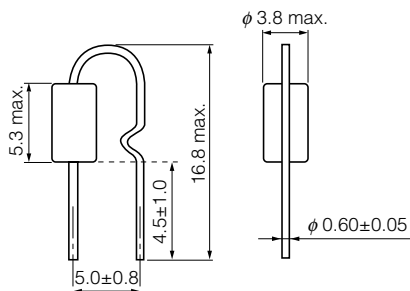

- EXCELDR35C

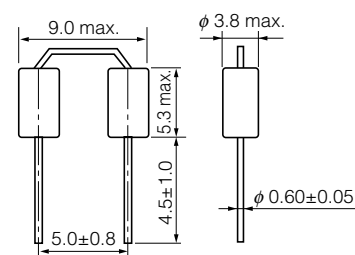

■ Taping Dimensions in mm (not to scale)

**Discontinued**

- EXCELSA24T
- EXCELSA35T
- EXCELSA24V
- EXCELSA35V
- EXCELSA39V

	ELSA24T	ELSA35T	ELSA24V	ELSA35V	ELSA39V
D	φ2.8 max.	φ3.8 max.	φ2.8 max.	φ3.8 max.	φ3.8 max.
A	4.8 max.	5.3 max.	4.8 max.	5.3 max.	9.3 max.
W	26.0 <sup>+0.5</sup>	26.0 <sup>+0.5</sup>	52±1	52±1	52±1
L <sub>1</sub> -L <sub>2</sub>	≤0.5	≤0.5	≤0.5	≤0.5	≤0.5

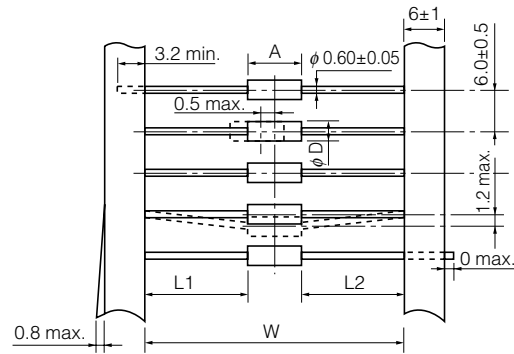

- EXCELSR35T

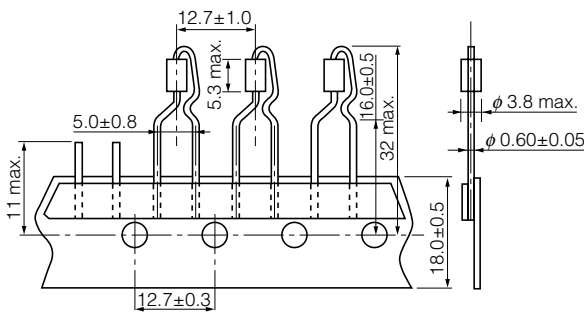

- EXCELSV35V

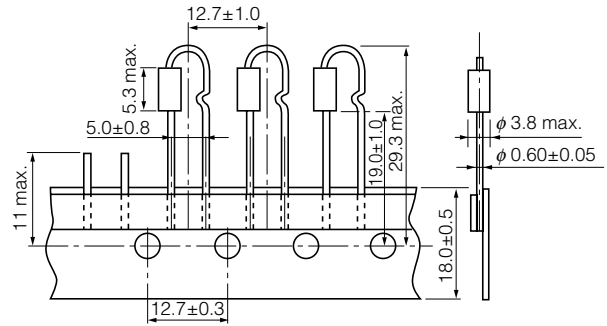

- EXCELDR35V

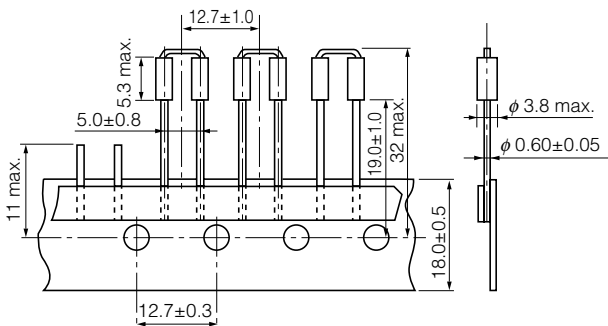

- EXCELDR25V
- EXCELDR27V

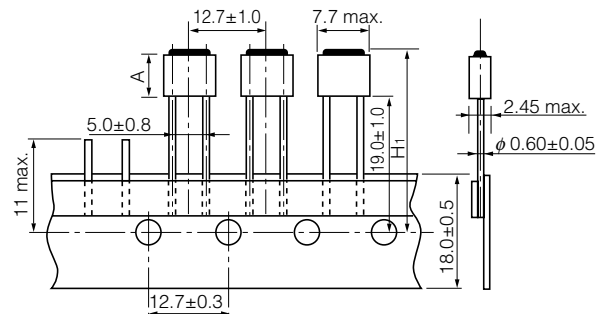

	ELDR25V	ELDR27V
A	5.3max.	7.8max.
H <sub>1</sub>	27max.	29.5max.

## Typical Impedance Characteristics

Discontinued

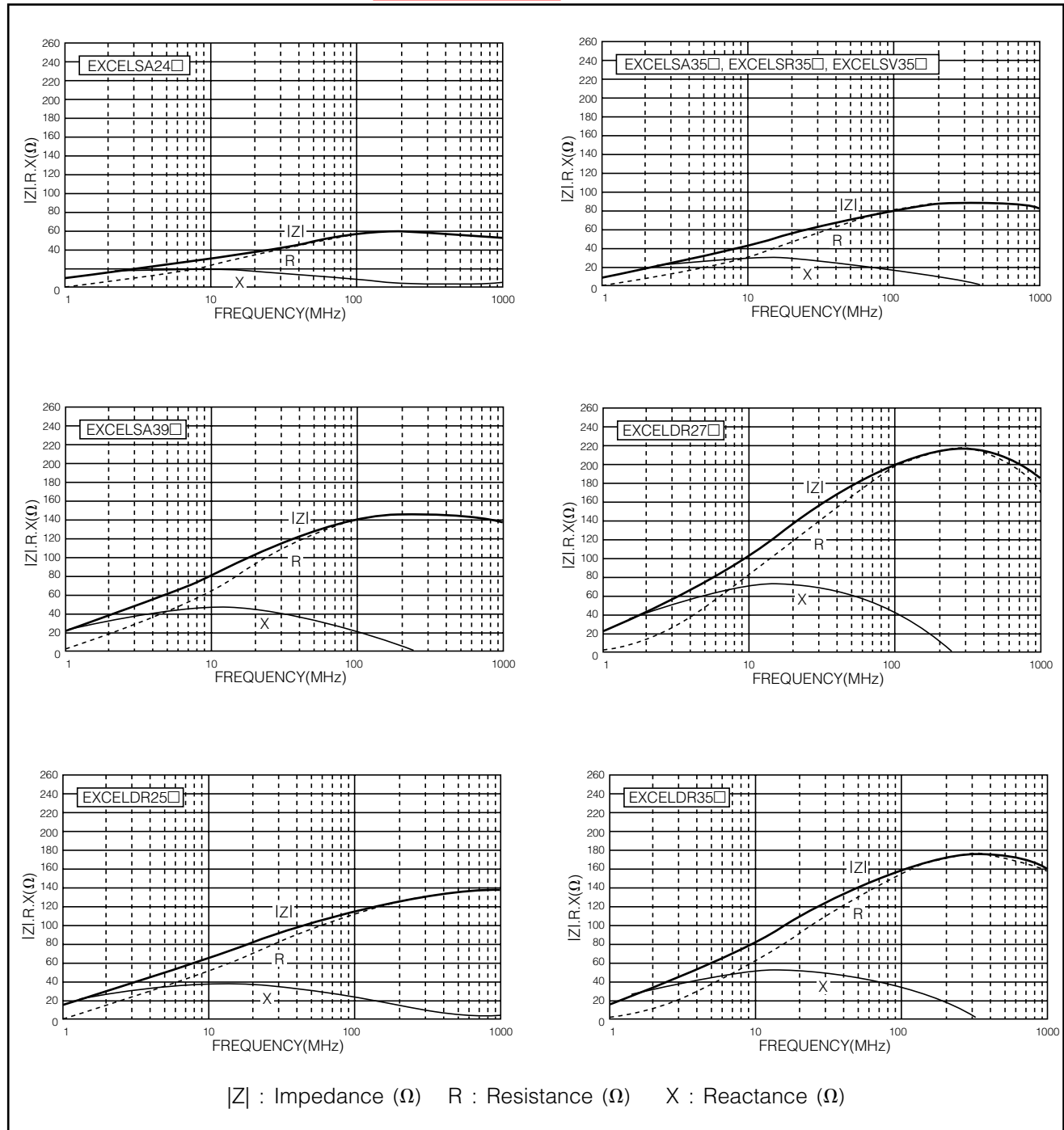

### **⚠ Safety Precautions**

The following are precautions for individual products. Please also refer to the common precautions for Noise Suppression Device shown on this catalog.

1. Use rosin-based flux or halogen-free flux.
2. For cleaning, use an alcohol-based cleaning agent. Before using any other type, consult with our sales person in advance.
3. Carefully handle EMI Bead Cores (hereafter called the bead cores) so as not to apply excessive mechanical stress to their bodies in order to avoid damaging them.
4. Store the bead cores in a location with a temperature ranging from  $-5\text{ }^{\circ}\text{C}$  to  $+40\text{ }^{\circ}\text{C}$  and a relative humidity of 40 % to 60 %, where there are no rapid changes in temperature or humidity.
5. Use the bead cores within a year after the date of the outgoing inspection indicated on the packages.

Design and specifications are each subject to change without notice. Ask factory for the current technical specifications before purchase and/or use. Should a safety concern arise regarding this product, please be sure to contact us immediately.