

# RF Power Field Effect Transistors

## N-Channel Enhancement-Mode Lateral MOSFETs

Designed for N-CDMA base station applications with frequencies from 1805 to 1880 MHz. Suitable for TDMA, CDMA and multicarrier amplifier applications. To be used in Class AB for PCN- PCS/cellular radio and WLL applications.

- Typical 2-Carrier N-CDMA Performance:  $V_{DD} = 28$  Volts,  $I_{DQ} = 1200$  mA,  $P_{out} = 29$  Watts Avg.,  $f = 1877.5$  MHz, IS-95 CDMA (Pilot, Sync, Paging, Traffic Codes 8 Through 13) Channel Bandwidth = 1.2288 MHz. PAR = 9.8 dB @ 0.01% Probability on CCDF.  
 Power Gain — 16 dB  
 Drain Efficiency — 27.5%  
 IM3 @ 2.5 MHz Offset — -36 dBc in 1.2288 MHz Bandwidth  
 ACPR @ 885 kHz Offset — -50.5 dBc in 30 kHz Bandwidth
- Capable of Handling 10:1 VSWR, @ 28 Vdc, 1840 MHz, 140 Watts CW Output Power

### Features

- Characterized with Series Equivalent Large-Signal Impedance Parameters
- Internally Matched for Ease of Use
- Qualified Up to a Maximum of 32  $V_{DD}$  Operation
- Integrated ESD Protection
- Designed for Lower Memory Effects and Wide Instantaneous Bandwidth Applications
- RoHS Compliant
- In Tape and Reel. R3 Suffix = 250 Units per 56 mm, 13 inch Reel.

**MRF6S18140HR3**  
**MRF6S18140HSR3**

**1805-1880 MHz, 29 W AVG., 28 V**  
**2 x N-CDMA**  
**LATERAL N-CHANNEL**  
**RF POWER MOSFETs**

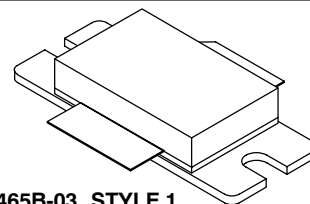

**CASE 465B-03, STYLE 1**  
**NI-880**  
**MRF6S18140HR3**

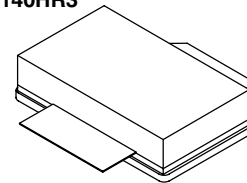

**CASE 465C-02, STYLE 1**  
**NI-880S**  
**MRF6S18140HSR3**

**Table 1. Maximum Ratings**

Rating	Symbol	Value	Unit
Drain-Source Voltage	$V_{DSS}$	-0.5, +68	Vdc
Gate-Source Voltage	$V_{GS}$	-0.5, +12	Vdc
Storage Temperature Range	$T_{stg}$	-65 to +150	°C
Case Operating Temperature	$T_C$	150	°C
Operating Junction Temperature (1,2)	$T_J$	225	°C

**Table 2. Thermal Characteristics**

Characteristic	Symbol	Value (2,3)	Unit
Thermal Resistance, Junction to Case	$R_{\theta JC}$		°C/W
Case Temperature 80°C, 140 W CW		0.31	
Case Temperature 73°C, 29 W CW		0.35	

1. Continuous use at maximum temperature will affect MTTF.
2. MTTF calculator available at <http://www.freescale.com/rf>. Select Software & Tools/Development Tools/Calculators to access MTTF calculators by product.
3. Refer to AN1955, *Thermal Measurement Methodology of RF Power Amplifiers*. Go to <http://www.freescale.com/rf>. Select Documentation/Application Notes - AN1955.

**Table 3. ESD Protection Characteristics**

Test Methodology	Class
Human Body Model (per JESD22-A114)	2 (Minimum)
Machine Model (per EIA/JESD22-A115)	A (Minimum)
Charge Device Model (per JESD22-C101)	IV (Minimum)

**Table 4. Electrical Characteristics** ( $T_A = 25^\circ\text{C}$  unless otherwise noted)

Characteristic	Symbol	Min	Typ	Max	Unit
----------------	--------	-----	-----	-----	------

**Off Characteristics**

Zero Gate Voltage Drain Leakage Current ( $V_{DS} = 68\text{ Vdc}$ , $V_{GS} = 0\text{ Vdc}$ )	$I_{DSS}$	—	—	10	$\mu\text{Adc}$
Zero Gate Voltage Drain Leakage Current ( $V_{DS} = 28\text{ Vdc}$ , $V_{GS} = 0\text{ Vdc}$ )	$I_{DSS}$	—	—	1	$\mu\text{Adc}$
Gate-Source Leakage Current ( $V_{GS} = 5\text{ Vdc}$ , $V_{DS} = 0\text{ Vdc}$ )	$I_{GSS}$	—	—	1	$\mu\text{Adc}$

**On Characteristics**

Gate Threshold Voltage ( $V_{DS} = 10\text{ Vdc}$ , $I_D = 300\ \mu\text{Adc}$ )	$V_{GS(th)}$	1.2	2	2.7	Vdc
Gate Quiescent Voltage ( $V_{DD} = 28\text{ Vdc}$ , $I_D = 1200\text{ mAdc}$ , Measured in Functional Test)	$V_{GS(Q)}$	2	2.7	3.8	Vdc
Drain-Source On-Voltage ( $V_{GS} = 10\text{ Vdc}$ , $I_D = 3\text{ Adc}$ )	$V_{DS(on)}$	0.1	0.22	0.3	Vdc

**Dynamic Characteristics (1)**

Reverse Transfer Capacitance ( $V_{DS} = 28\text{ Vdc} \pm 30\text{ mV(rms)ac}$ @ 1 MHz, $V_{GS} = 0\text{ Vdc}$ )	$C_{rss}$	—	2.2	—	pF
Output Capacitance ( $V_{DS} = 28\text{ Vdc} \pm 30\text{ mV(rms)ac}$ @ 1 MHz, $V_{GS} = 0\text{ Vdc}$ )	$C_{oss}$	—	685	—	pF

**Functional Tests** (In Freescale Test Fixture, 50 ohm system)  $V_{DD} = 28\text{ Vdc}$ ,  $I_{DQ} = 1200\text{ mA}$ ,  $P_{out} = 29\text{ W Avg.}$ ,  $f_1 = 1877.5\text{ MHz}$ ,  $f_2 = 1880\text{ MHz}$ , 2-Carrier N-CDMA, 1.2288 MHz Channel Bandwidth Carriers. ACPR measured in 30 kHz Channel Bandwidth @  $\pm 885\text{ kHz}$  Offset. IM3 measured in 1.2288 MHz Channel Bandwidth @  $\pm 2.5\text{ MHz}$  Offset. PAR = 9.8 dB @ 0.01% Probability on CCDF.

Power Gain	$G_{ps}$	15	16	18	dB
Drain Efficiency	$\eta_D$	25.5	27.5	—	%
Intermodulation Distortion	IM3	—	-36	-34.5	dBc
Adjacent Channel Power Ratio	ACPR	—	-50.5	-48	dBc
Input Return Loss	IRL	—	-10.5	—	dB

1. Part internally matched both on input and output.

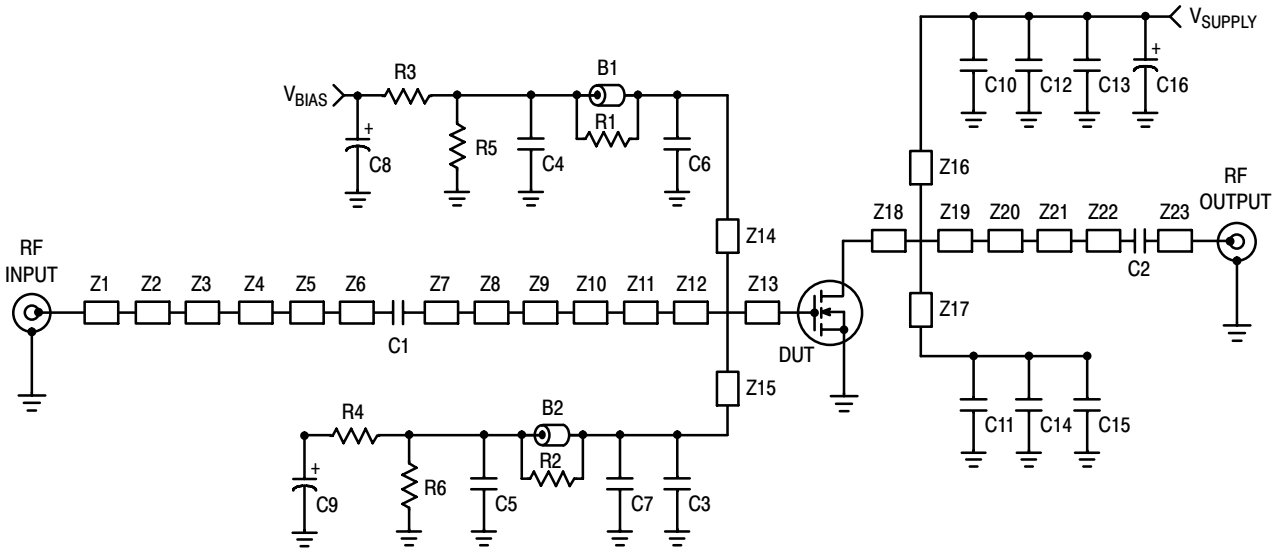

Z1	0.166" x 0.082" Microstrip	Z13	0.108" x 1.070" Microstrip
Z2	0.250" x 0.334" Microstrip	Z14	0.960" x 0.046" Microstrip
Z3	0.140" x 0.340" Microstrip	Z15	0.084" x 0.046" Microstrip
Z4	0.092" x 0.164" Microstrip	Z16	0.996" x 0.080" Microstrip
Z5	0.130" x 0.234" Microstrip	Z17	1.015" x 0.080" Microstrip
Z6	0.109" x 0.082" Microstrip	Z18	0.099" x 1.070" Microstrip
Z7	0.070" x 0.082" Microstrip	Z19	0.516" x 1.070" Microstrip
Z8	0.350" x 0.644" Microstrip	Z20	0.292" x 0.288" Microstrip
Z9	0.092" x 0.420" Microstrip	Z21	0.198" x 0.114" Microstrip
Z10	0.720" x 0.082" Microstrip	Z22	0.372" x 0.080" Microstrip
Z11	0.090" x 0.485" x 0.580" Taper	Z23	1.181" x 0.080" Microstrip
Z12	0.342" x 1.070" Microstrip	PCB	DS Electronics GX0300, 0.030", $\epsilon_r = 2.55$

Figure 1. MRF6S18140HR3(HSR3) Test Circuit Schematic

Table 5. MRF6S18140HR3(HSR3) Test Circuit Component Designations and Values

Part	Description	Part Number	Manufacturer
B1, B2	47 $\Omega$ , 100 MHz Small Ferrite Beads, Surface Mount	2743019447	Fair-Rite
C1, C2	39 pF Chip Capacitors	ATC700B390FT500XT	ATC
C3	0.1 pF Chip Capacitor	ATC100B0R1BT500XT	ATC
C4, C5, C12, C13, C14, C15	10 $\mu$ F, 50 V Chip Capacitors	GRM55DR61H106KA88B	Murata
C6, C7, C10, C11	9.1 pF Chip Capacitors	ATC100B9R1BT500XT	ATC
C8, C9	47 $\mu$ F, 50 V Electrolytic Capacitors	EMVY500ADA470MF80G	Nippon Chemi-Con
C16	470 $\mu$ F, 63 V Electrolytic Capacitor	EMVY630GTR471MMH0S	Nippon Chemi-Con
R1, R2	12 $\Omega$ , 1/4 W Resistors	CRCW120612R0FKEA	Vishay
R3, R4	1.0 K $\Omega$ , 1/4 W Resistors	CRCW12061001FKEA	Vishay
R5, R6	560 K $\Omega$ , 1/4 W Chip Resistors	CRCW12065602FKEA	Vishay

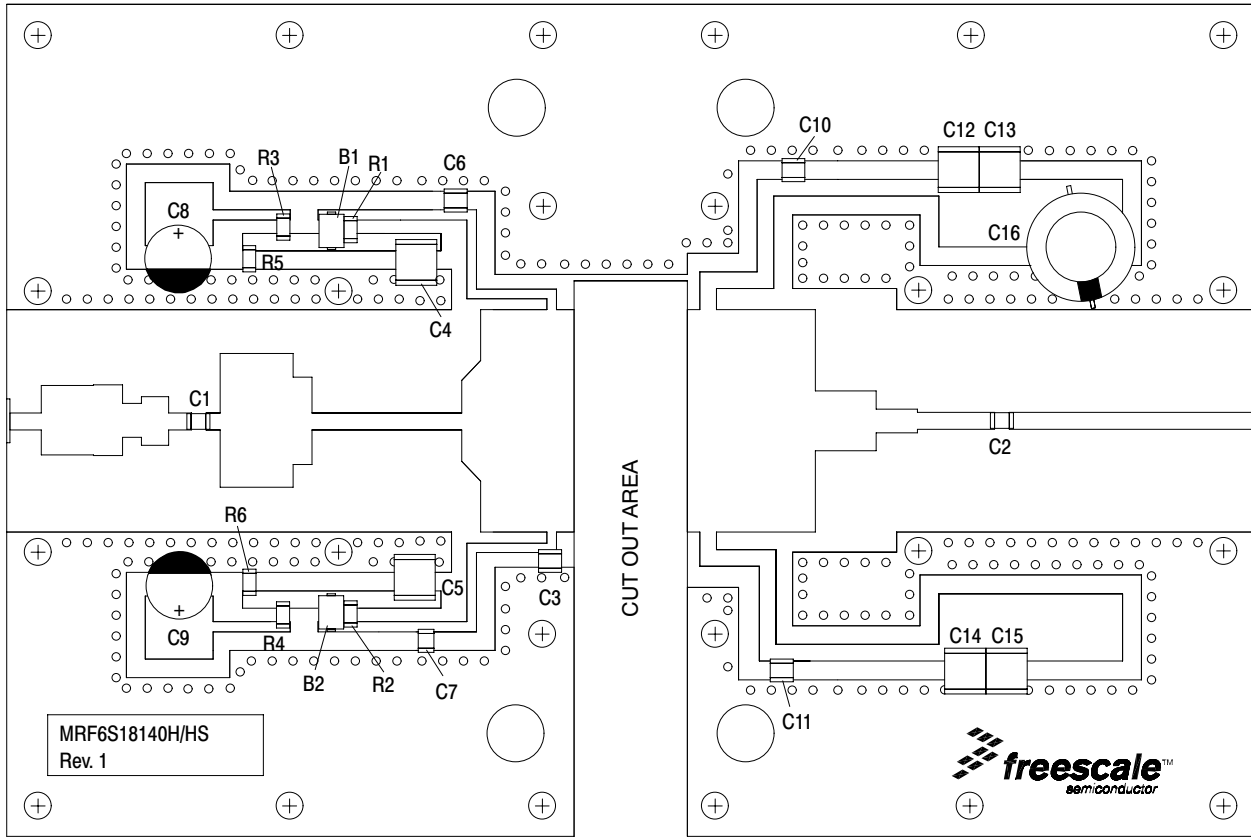

Figure 2. MRF6S18140HR3(HSR3) Test Circuit Component Layout

### TYPICAL CHARACTERISTICS

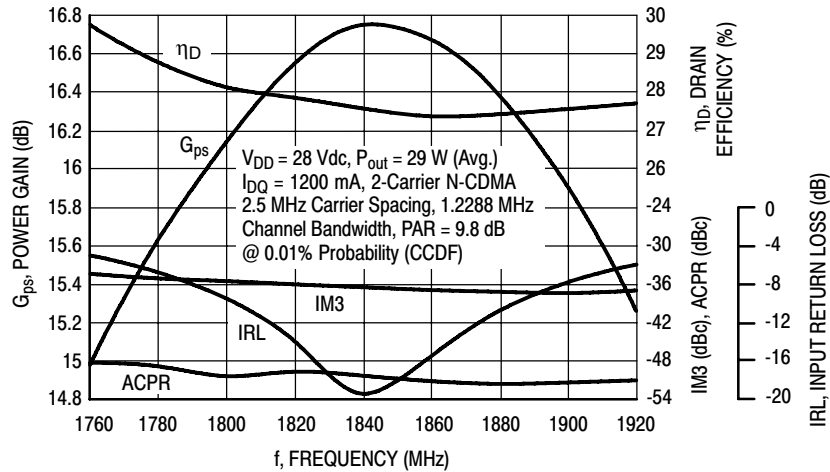

Figure 3. 2-Carrier N-CDMA Broadband Performance @  $P_{out} = 29$  Watts Avg.

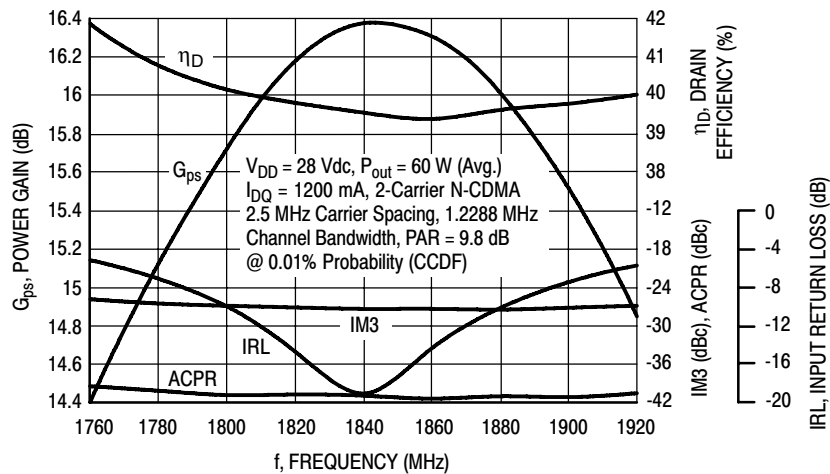

Figure 4. 2-Carrier N-CDMA Broadband Performance @  $P_{out} = 60$  Watts Avg.

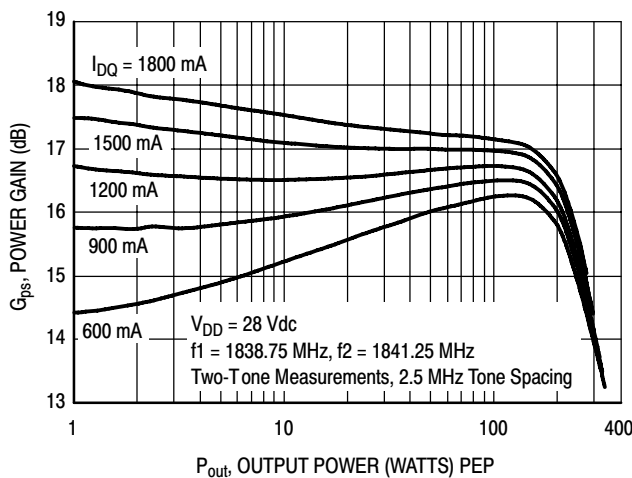

Figure 5. Two-Tone Power Gain versus Output Power

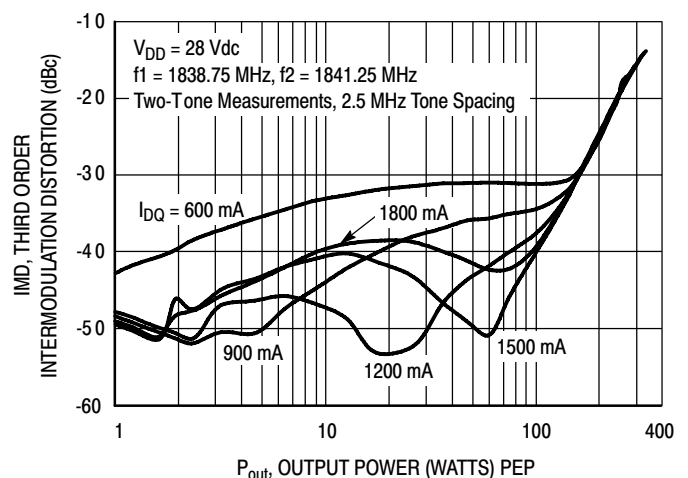
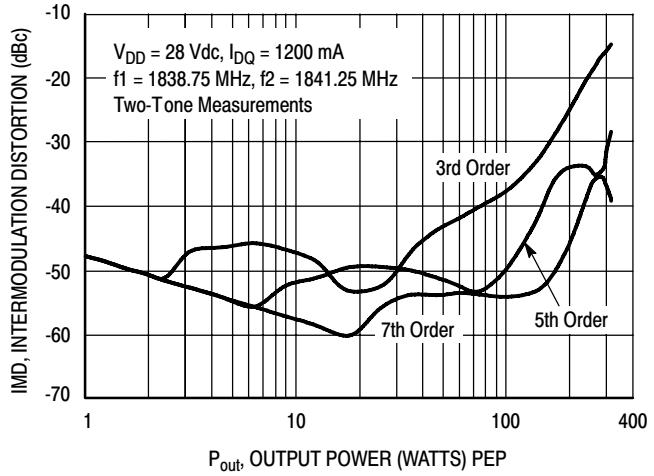

Figure 6. Third Order Intermodulation Distortion versus Output Power

ARCHIVE INFORMATION

ARCHIVE INFORMATION

### TYPICAL CHARACTERISTICS



**Figure 7. Intermodulation Distortion Products versus Output Power**

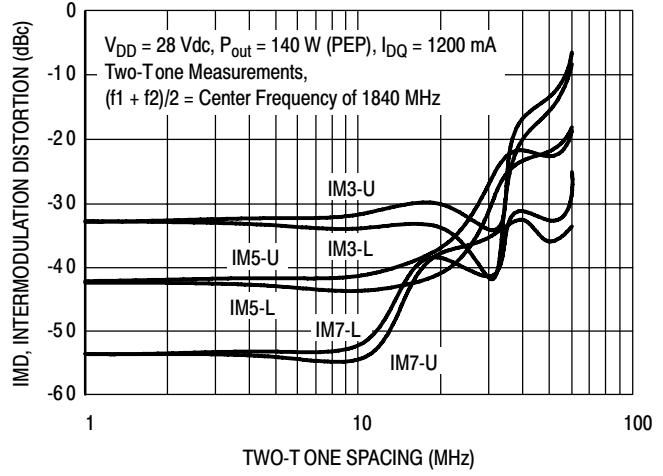

**Figure 8. Intermodulation Distortion Products versus Tone Spacing**

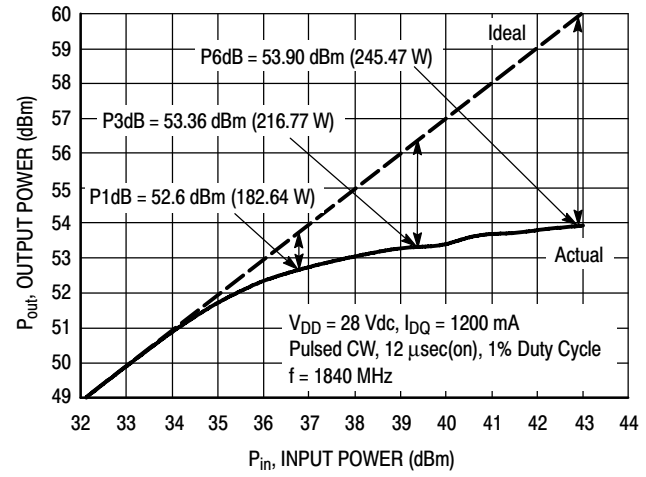

**Figure 9. Pulsed CW Output Power versus Input Power**

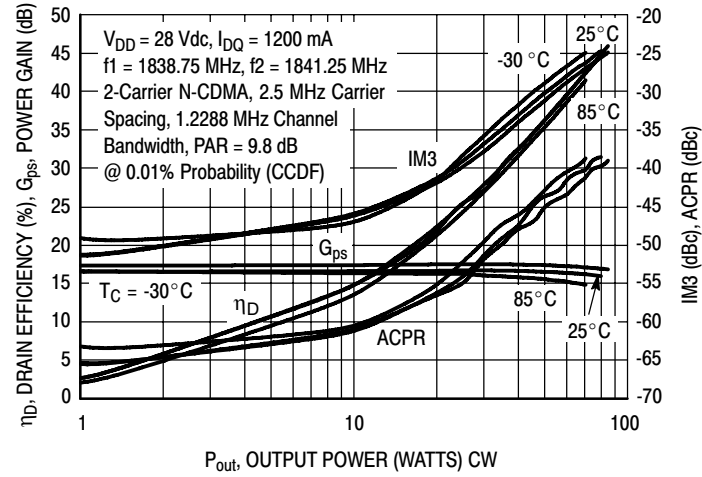
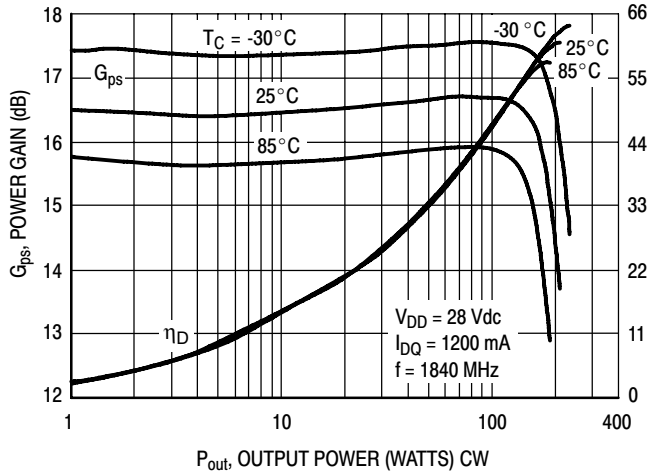

**Figure 10. 2-Carrier N-CDMA ACPR, IM3, Power Gain and Drain Efficiency versus Output Power**

ARCHIVE INFORMATION

ARCHIVE INFORMATION

### TYPICAL CHARACTERISTICS



**Figure 11. Power Gain and Drain Efficiency versus CW Output Power**

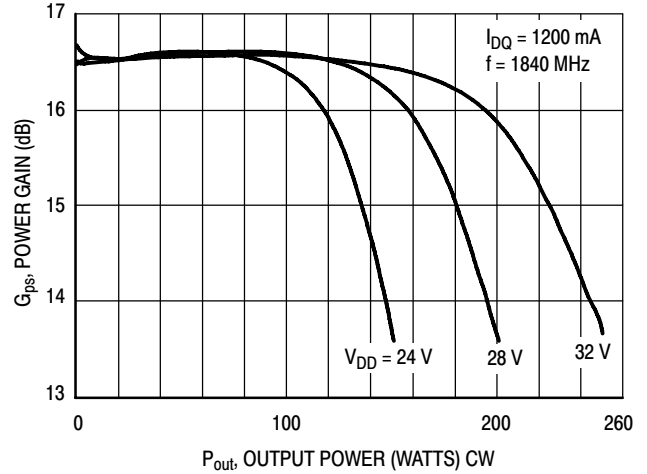

**Figure 12. Power Gain versus Output Power**

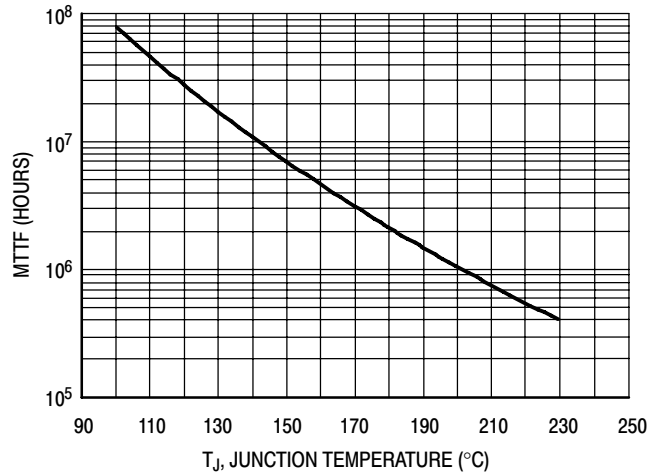

This above graph displays calculated MTTF in hours when the device is operated at  $V_{DD} = 28$  Vdc,  $P_{out} = 29$  W Avg., and  $\eta_D = 27.5\%$ .

MTTF calculator available at <http://www.freescale.com/rf>. Select Software & Tools/Development Tools/Calculators to access MTTF calculators by product.

**Figure 13. MTTF Factor versus Junction Temperature**

### N-CDMA TEST SIGNAL

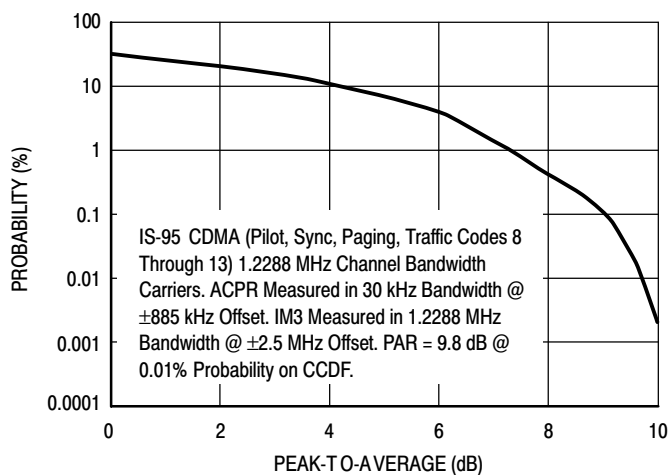

Figure 14. 2-Carrier CCDF N-CDMA

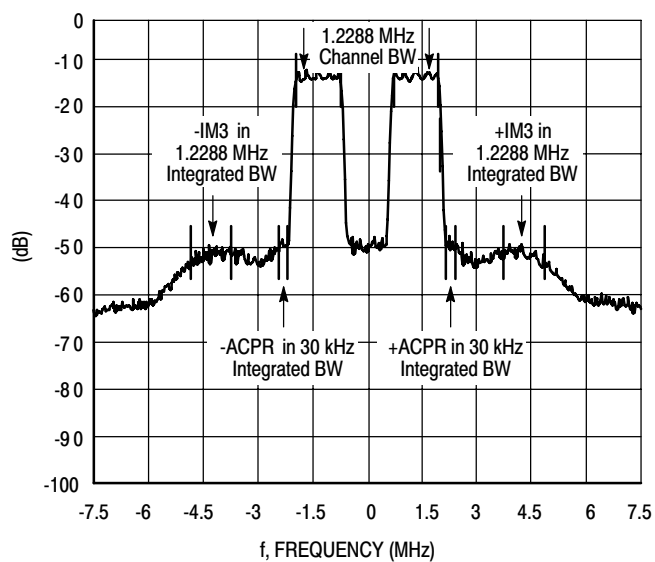
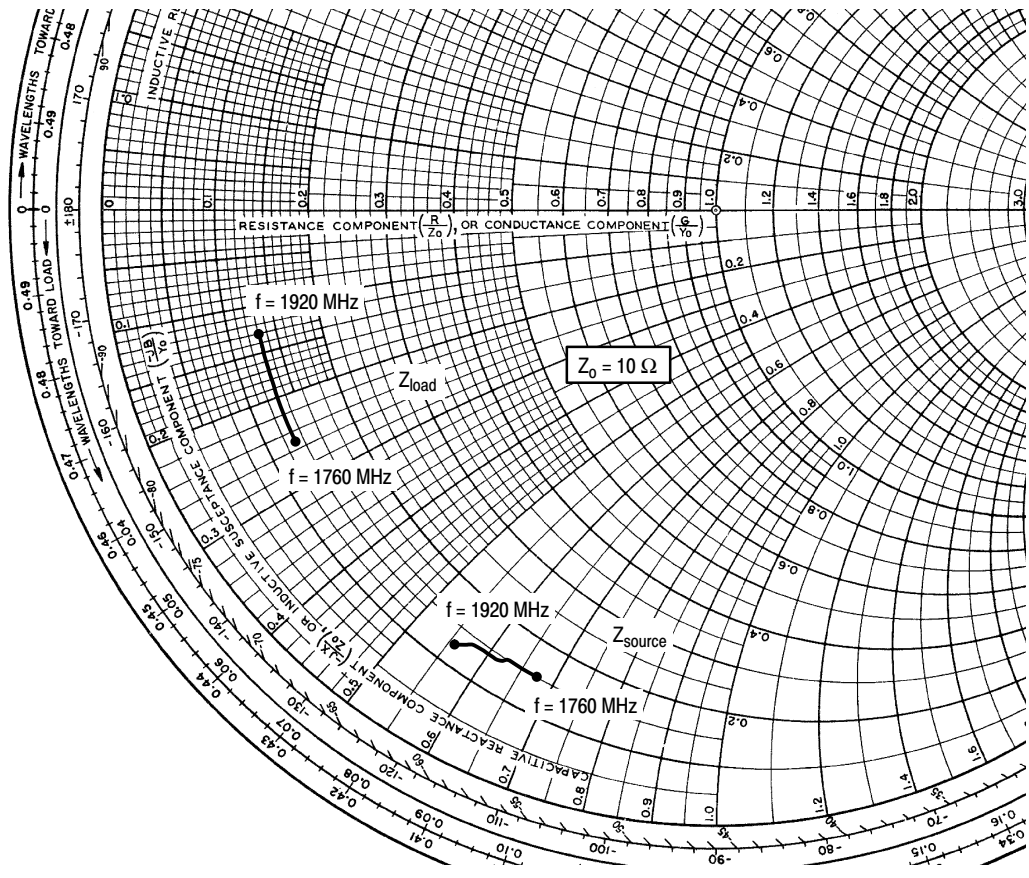

Figure 15. 2-Carrier N-CDMA Spectrum

ARCHIVE INFORMATION

ARCHIVE INFORMATION





$V_{DD} = 28 \text{ Vdc}$ ,  $I_{DQ} = 1200 \text{ mA}$ ,  $P_{out} = 29 \text{ W Avg.}$

f MHz	$Z_{source}$ $\Omega$	$Z_{load}$ $\Omega$
1760	1.454 - j6.703	1.344 - j2.479
1780	1.465 - j6.511	1.338 - j2.299
1800	1.467 - j6.336	1.333 - j2.129
1820	1.448 - j6.193	1.325 - j1.966
1840	1.440 - j6.049	1.308 - j1.801
1860	1.414 - j5.938	1.301 - j1.687
1880	1.377 - j5.827	1.303 - j1.550
1900	1.311 - j5.710	1.301 - j1.419
1920	1.231 - j5.583	1.289 - j1.303

$Z_{source}$  = Test circuit impedance as measured from gate to ground.

$Z_{load}$  = Test circuit impedance as measured from drain to ground.

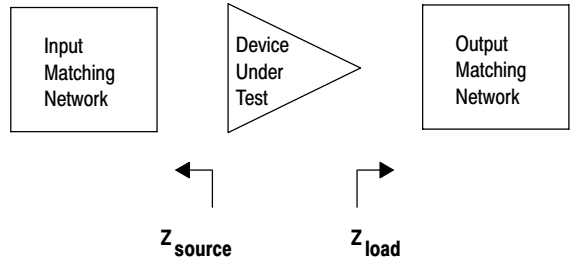
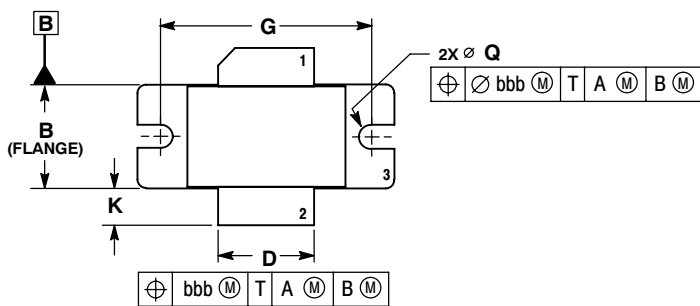

Figure 16. Series Equivalent Source and Load Impedance

### PACKAGE DIMENSIONS



- NOTES:
1. DIMENSIONING AND TOLERANCING PER ANSI Y14.5M-1994.
  2. CONTROLLING DIMENSION: INCH.
  3. DIMENSION H IS MEASURED 0.030 (0.762) AWAY FROM PACKAGE BODY.
  4. DELETED

DIM	INCHES		MILLIMETERS	
	MIN	MAX	MIN	MAX
A	1.335	1.345	33.91	34.16
B	0.535	0.545	13.6	13.8
C	0.147	0.200	3.73	5.08
D	0.495	0.505	12.57	12.83
E	0.035	0.045	0.89	1.14
F	0.003	0.006	0.08	0.15
G	1.100 BSC		27.94 BSC	
H	0.057	0.067	1.45	1.70
K	0.170	0.210	4.32	5.33
M	0.872	0.888	22.15	22.55
N	0.871	0.889	19.30	22.60
Q	∅ .118	∅ .138	∅ 3.00	∅ 3.51
R	0.515	0.525	13.10	13.30
S	0.515	0.525	13.10	13.30
aaa	0.007 REF		0.178 REF	
bbb	0.010 REF		0.254 REF	
ccc	0.015 REF		0.381 REF	

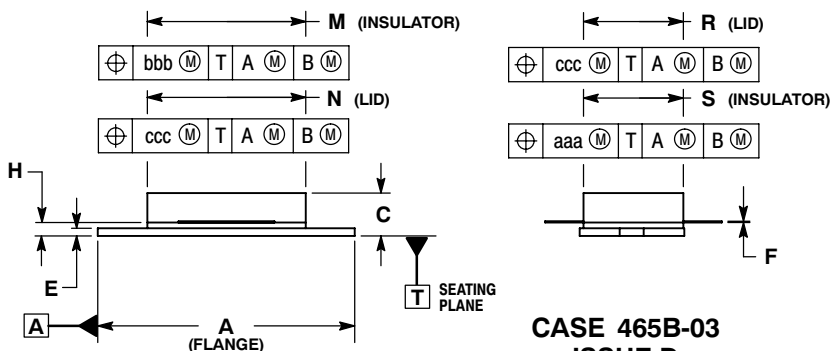

**CASE 465B-03  
ISSUE D  
NI-880  
MRF6S18140HR3**

- STYLE 1:  
PIN 1. DRAIN  
2. GATE  
3. SOURCE

ARCHIVE INFORMATION

ARCHIVE INFORMATION

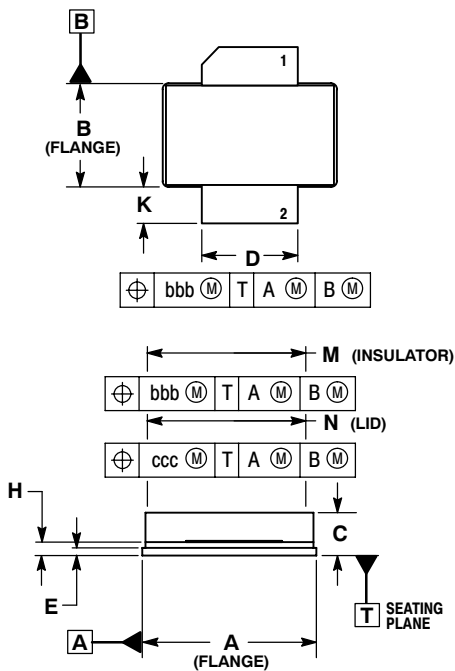

- NOTES:
1. DIMENSIONING AND TOLERANCING PER ANSI Y14.5M-1994.
  2. CONTROLLING DIMENSION: INCH.
  3. DIMENSION H IS MEASURED 0.030 (0.762) AWAY FROM PACKAGE BODY.

DIM	INCHES		MILLIMETERS	
	MIN	MAX	MIN	MAX
A	0.905	0.915	22.99	23.24
B	0.535	0.545	13.60	13.80
C	0.147	0.200	3.73	5.08
D	0.495	0.505	12.57	12.83
E	0.035	0.045	0.89	1.14
F	0.003	0.006	0.08	0.15
H	0.057	0.067	1.45	1.70
K	0.170	0.210	4.32	5.33
M	0.872	0.888	22.15	22.55
N	0.871	0.889	19.30	22.60
R	0.515	0.525	13.10	13.30
S	0.515	0.525	13.10	13.30
aaa	0.007 REF		0.178 REF	
bbb	0.010 REF		0.254 REF	
ccc	0.015 REF		0.381 REF	

**CASE 465C-02  
ISSUE D  
NI-880S  
MRF6S18140HSR3**

- STYLE 1:  
PIN 1. DRAIN  
2. GATE  
3. SOURCE

## PRODUCT DOCUMENTATION

Refer to the following documents to aid your design process.

### Application Notes

- AN1955: Thermal Measurement Methodology of RF Power Amplifiers

### Engineering Bulletins

- EB212: Using Data Sheet Impedances for RF LDMOS Devices

## REVISION HISTORY

The following table summarizes revisions to this document.

Revision	Date	Description
0	Sept. 2006	<ul style="list-style-type: none"> <li>• Initial Release of Data Sheet</li> </ul>
1	Dec. 2008	<ul style="list-style-type: none"> <li>• Modified data sheet to reflect RF Test Reduction described in Product and Process Change Notification number, PCN13232, p. 1, 2</li> <li>• Removed Lower Thermal Resistance and Low Gold Plating bullets from Features section as functionality is standard, p. 1</li> <li>• Corrected <math>V_{DS}</math> to <math>V_{DD}</math> in the RF test condition voltage callout for <math>V_{GS(Q)}</math>, and added "Measured in Functional Test", On Characteristics table, p. 2</li> <li>• Updated Part Numbers in Table 5, Component Designations and Values, to latest RoHS compliant part numbers, p. 3</li> <li>• Adjusted scale for Fig. 8, Intermodulation Distortion Products versus Tone Spacing, to show wider dynamic range, p. 6</li> <li>• Replaced Fig. 13, MTTF versus Junction Temperature with updated graph. Removed Amps<sup>2</sup> and listed operating characteristics and location of MTTF calculator for device, p. 7</li> </ul>
1.1	Dec. 2009	<ul style="list-style-type: none"> <li>• Corrected data sheet to reflect RF Test Reduction frequency described in Product and Process Change Notification number, PCN13232, p. 1, 2</li> <li>• Data sheet archived. Part no longer manufactured.</li> </ul>

ARCHIVE INFORMATION

ARCHIVE INFORMATION

**How to Reach Us:****Home Page:**

[www.freescale.com](http://www.freescale.com)

**Web Support:**

<http://www.freescale.com/support>

**USA/Europe or Locations Not Listed:**

Freescale Semiconductor, Inc.  
Technical Information Center, EL516  
2100 East Elliot Road  
Tempe, Arizona 85284  
1-800-521-6274 or +1-480-768-2130  
[www.freescale.com/support](http://www.freescale.com/support)

**Europe, Middle East, and Africa:**

Freescale Halbleiter Deutschland GmbH  
Technical Information Center  
Schatzbogen 7  
81829 Muenchen, Germany  
+44 1296 380 456 (English)  
+46 8 52200080 (English)  
+49 89 92103 559 (German)  
+33 1 69 35 48 48 (French)  
[www.freescale.com/support](http://www.freescale.com/support)

**Japan:**

Freescale Semiconductor Japan Ltd.  
Headquarters  
ARCO Tower 15F  
1-8-1, Shimo-Meguro, Meguro-ku,  
Tokyo 153-0064  
Japan  
0120 191014 or +81 3 5437 9125  
[support.japan@freescale.com](mailto:support.japan@freescale.com)

**Asia/Pacific:**

Freescale Semiconductor China Ltd.  
Exchange Building 23F  
No. 118 Jianguo Road  
Chaoyang District  
Beijing 100022  
China  
+86 10 5879 8000  
[support.asia@freescale.com](mailto:support.asia@freescale.com)

**For Literature Requests Only:**

Freescale Semiconductor Literature Distribution Center  
1-800-441-2447 or +1-303-675-2140  
Fax: +1-303-675-2150  
[LDCForFreescaleSemiconductor@hibbertgroup.com](mailto:LDCForFreescaleSemiconductor@hibbertgroup.com)

Information in this document is provided solely to enable system and software implementers to use Freescale Semiconductor products. There are no express or implied copyright licenses granted hereunder to design or fabricate any integrated circuits or integrated circuits based on the information in this document.

Freescale Semiconductor reserves the right to make changes without further notice to any products herein. Freescale Semiconductor makes no warranty, representation or guarantee regarding the suitability of its products for any particular purpose, nor does Freescale Semiconductor assume any liability arising out of the application or use of any product or circuit, and specifically disclaims any and all liability, including without limitation consequential or incidental damages. "Typical" parameters that may be provided in Freescale Semiconductor data sheets and/or specifications can and do vary in different applications and actual performance may vary over time. All operating parameters, including "Typicals", must be validated for each customer application by customer's technical experts. Freescale Semiconductor does not convey any license under its patent rights nor the rights of others. Freescale Semiconductor products are not designed, intended, or authorized for use as components in systems intended for surgical implant into the body, or other applications intended to support or sustain life, or for any other application in which the failure of the Freescale Semiconductor product could create a situation where personal injury or death may occur. Should Buyer purchase or use Freescale Semiconductor products for any such unintended or unauthorized application, Buyer shall indemnify and hold Freescale Semiconductor and its officers, employees, subsidiaries, affiliates, and distributors harmless against all claims, costs, damages, and expenses, and reasonable attorney fees arising out of, directly or indirectly, any claim of personal injury or death associated with such unintended or unauthorized use, even if such claim alleges that Freescale Semiconductor was negligent regarding the design or manufacture of the part.

Freescale™ and the Freescale logo are trademarks of Freescale Semiconductor, Inc. All other product or service names are the property of their respective owners.

© Freescale Semiconductor, Inc. 2006, 2008-2009. All rights reserved.