

PQ07VR5MAZ Series

Low Power-Loss Voltage Regulators with Reset Signal Generating Function in Detecting Input Voltage Drop

■ Features

- Built-in reset signal generating function
(The reset detection voltage can be custom-ordered in the range of 3.5 to 4.5V.)
- Low power-loss (Dropout voltage: Max. 0.5V at $I_o=0.3A$)
- Compact, surface mount package (Equivalent to SC-63)
- Variable output voltage type (1.5 to 7V)
- Overcurrent protection and overheat protection function
- Tape-packaged products and sleeve-packaged products are available.

■ Applications

- Power supplies for AV, OA equipment, and various electronic equipment
- CD-ROM drives and CD-R drives
- DVD-ROM drives

■ Outline Dimensions

(Unit : mm)

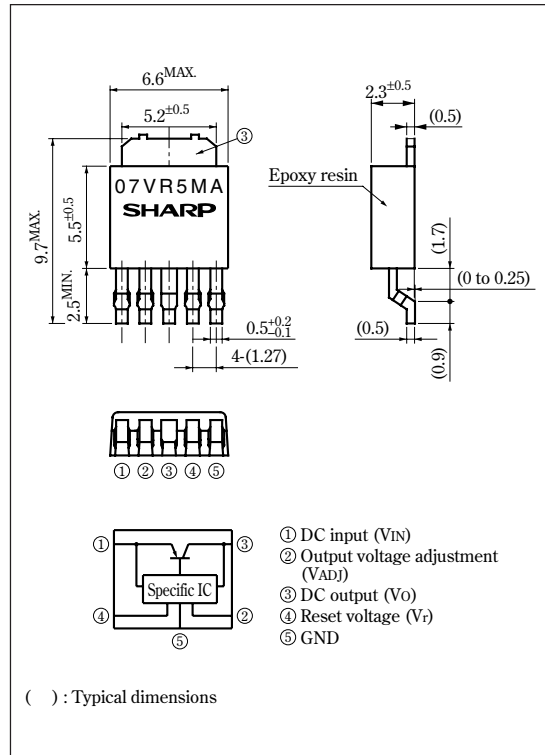

■ Absolute Maximum Ratings

($T_a=25^{\circ}C$)

Parameter	Symbol	Rating	Unit
*1 Input voltage	V_{IN}	10	V
*1 Output adjustment terminal voltage	V_{ADJ}	7	V
*1 Reset output voltage	V_r	10	V
Output current	I_o	500	mA
Reset output current	I_r	5	mA
*2 Power dissipation	P_D	8	W
*3 Junction temperature	T_j	150	$^{\circ}C$
Operating temperature	T_{opr}	-20 to +80	$^{\circ}C$
Storage temperature	T_{stg}	-40 to +150	$^{\circ}C$
Soldering temperature	T_{sol}	260 (10s)	$^{\circ}C$

*1 All are open except GND and applicable terminals

*2 P_D : With infinite heat sink

*3 Overheat protection may operate at the condition $T_j=125^{\circ}C$ to $150^{\circ}C$

• Please refer to the chapter " Handling Precautions ".

SHARP

Notice In the absence of confirmation by device specification sheets, SHARP takes no responsibility for any defects that may occur in equipment using any SHARP devices shown in catalogs, data books, etc. Contact SHARP in order to obtain the latest device specification sheets before using any SHARP device.
Internet Internet address for Electronic Components Group <http://sharp-world.com/ecg/>

Electrical Characteristics (Unless otherwise specified, condition shall be $V_{IN}=5V$, $V_O=3V$ ($R_1=1k\Omega$), $I_O=300mA$, $T_a=25^\circ C$)

Parameter	Symbol	Conditions	MIN.	TYP.	MAX.	Unit
Input voltage	V_{IN}	—	3.4	—	10	V
Output voltage	V_O	—	1.5	—	7	V
Load regulation	R_{egL}	$I_O=5mA$ to $0.5A$	—	0.3	2	%
Line regulation	R_{egI}	$V_{IN}=5$ to $7V$, $I_O=5mA$	—	0.5	2	%
Ripple rejection	RR	Refer to Fig.2	45	60	—	dB
Dropout voltage	V_{I-O}	$V_{IN}=3.4V$	—	—	0.5	V
Reference voltage	V_{ref}	—	1.22	1.245	1.27	V
Temperature coefficient of reference voltage	$T_C V_{ref}$	$T_j=0$ to $125^\circ C$, $I_O=5mA$	—	± 1	—	%
Quiescent current	I_q	$I_O=0A$	—	—	5	mA
Input detection voltage	V_{ri}	$V_r=0.8$, $R_r=10k\Omega$, $I_O=5mA$	4.116	4.2	4.284	V
"L" Reset output voltage	V_{rl}	$2.5V < V_{IN} < V_{ri}$, $I_O=5mA$	—	—	0.8	V
Hysteresis voltage	ΔV_{ri}	$R_r=10k\Omega$	50	150	200	mV
Reset output leak current	I_{rlk}	$V_r=5V$, $R_r=10k\Omega$	—	—	1	μA

Reset Threshold Voltage Line-up

Parameter	Symbol	Conditions	MIN.	TYP.	MAX.	Unit
Reset threshold voltage	V_{rt}	*4 $V_r \leq 0.8V$, $R_r=10k\Omega$	4.116	4.2	4.284	V
			4.214	4.3	4.386	
			4.312	4.4	4.488	
			4.41	4.5	4.59	

*4 Output voltage shall be the value when input voltage lowers and V_r becomes low

Fig.1 Test Circuit

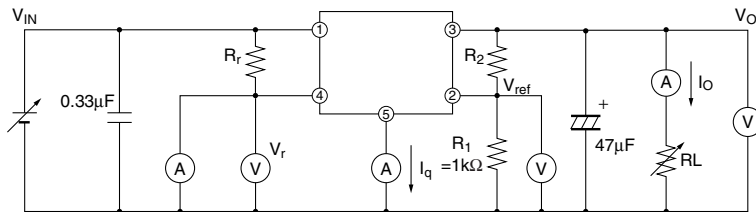

Fig.2 Test Circuit for Ripple Rejection

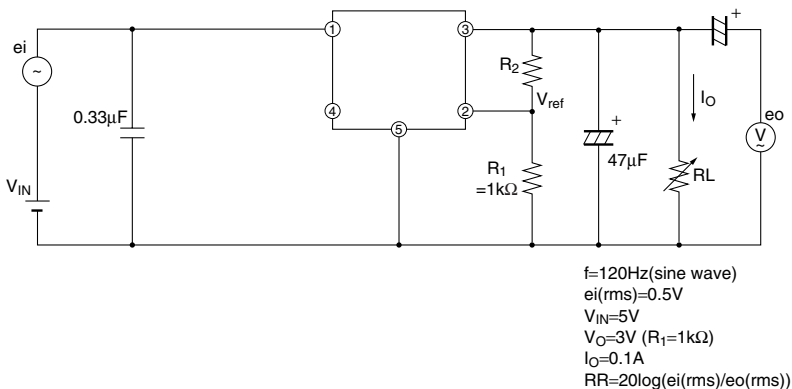
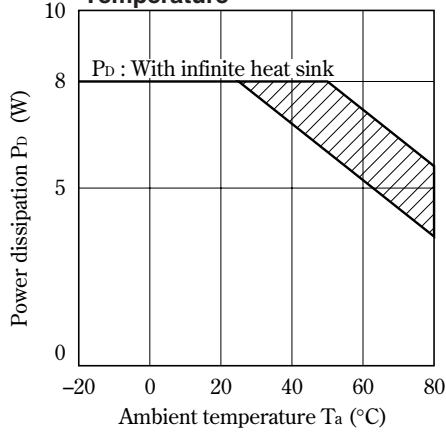

Fig.3 Power Dissipation vs. Ambient Temperature



(Note) Oblique line portion: Overheat protection may operate in this area.

Fig.5 Reference Voltage Fluctuation vs. Ambient Temperature

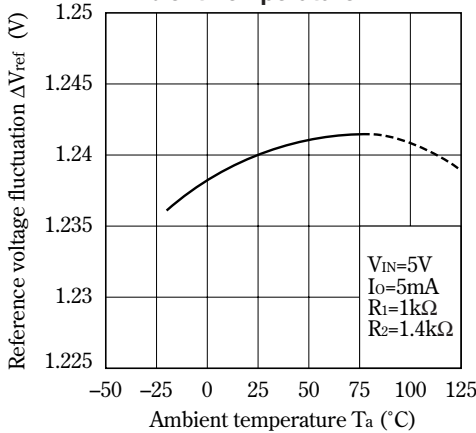

Fig.7 Circuit Operating Current vs. Input Voltage

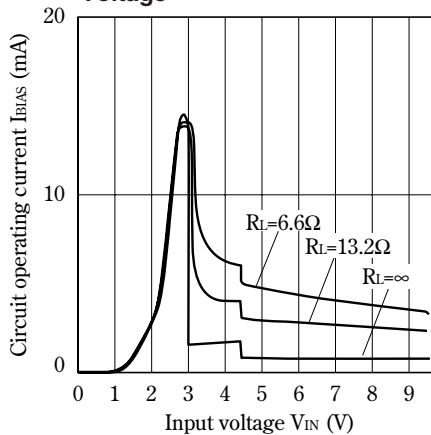

Fig.4 Overcurrent Protection Characteristics (Output:3V)

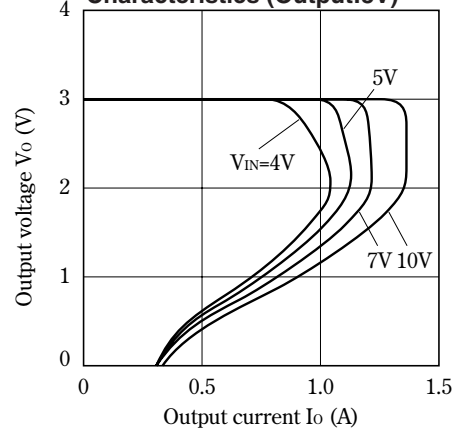

Fig.6 Output Voltage vs. Input Voltage (Output:3V)

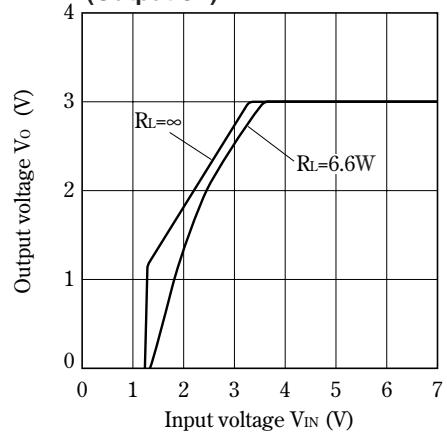

Fig.8 Quiescent Current vs. Junction Temperature

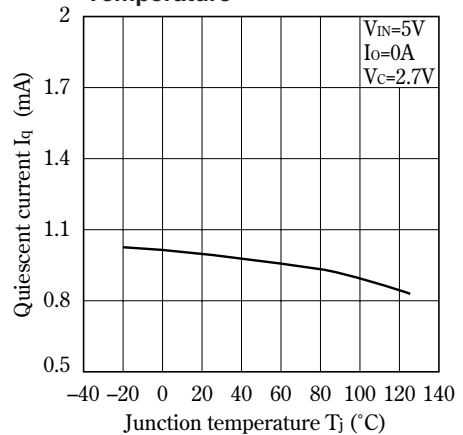

Fig.9 Reset Output Voltage vs. Input Voltage

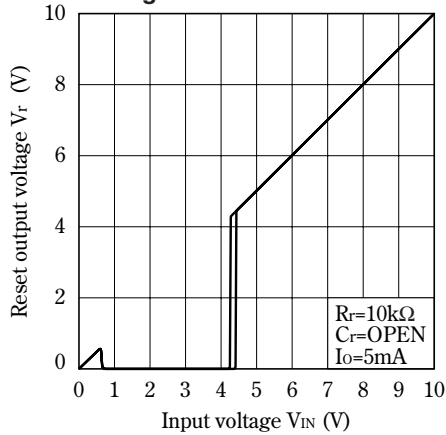

Fig.10 Input Detection Voltage vs. Junction Temperature

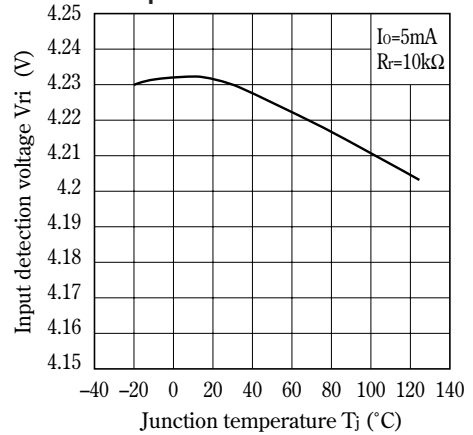

Fig.11 Hysteresis Voltage vs. Junction Temperature

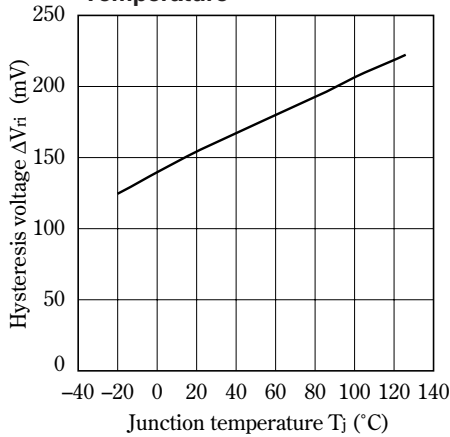

Fig.12 Ripple Rejection vs. Input Ripple Frequency

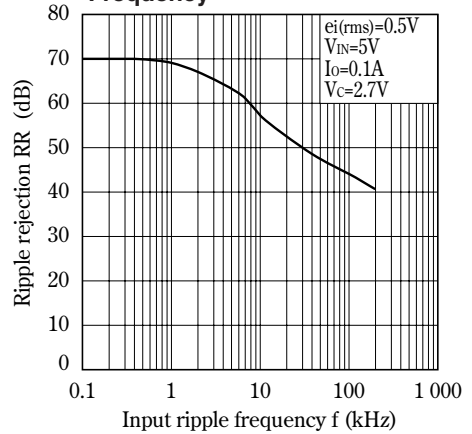

Fig.13 Ripple Rejection vs. Output Current

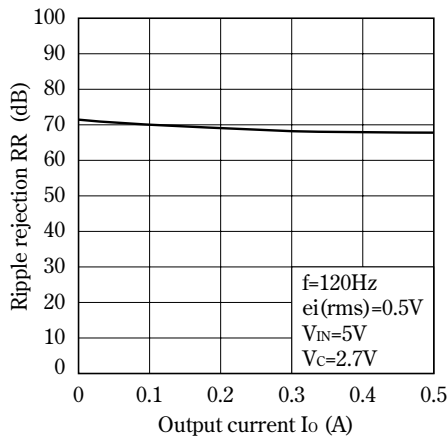

Fig.14 Typical Application

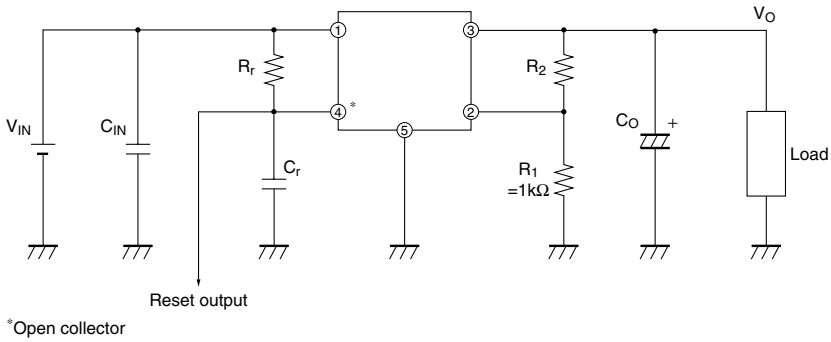

Fig.15 Reset Output Response (Typical Value)

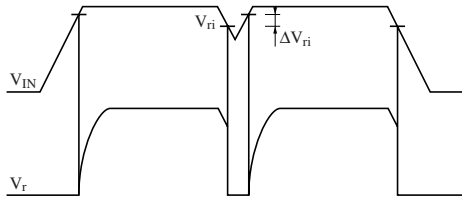

Fig.16 Reset Output Delay Time vs. Time Constant (Typical Value)

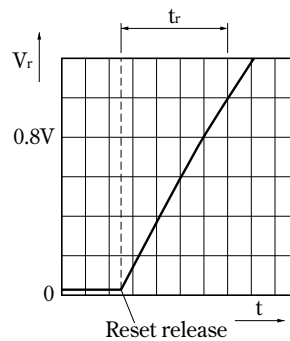
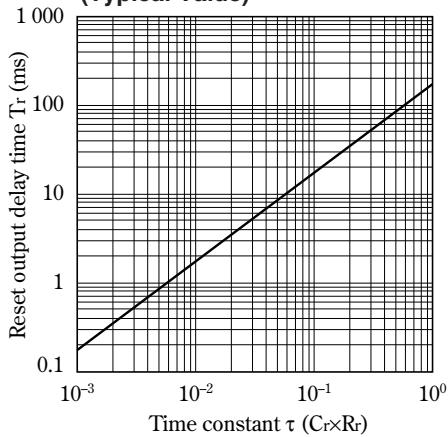

Fig.17 External Connection

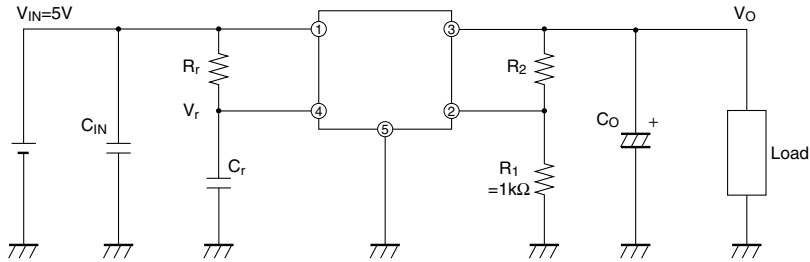
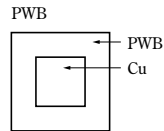
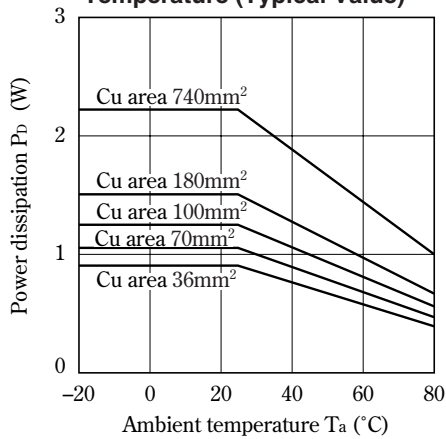
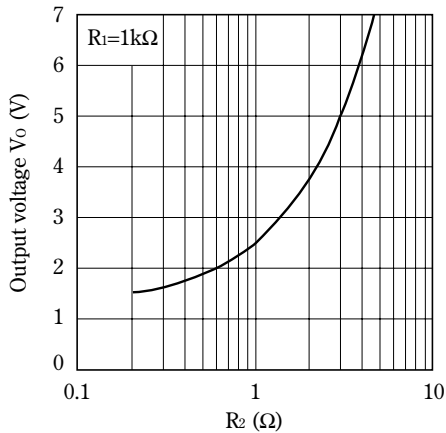

Fig.18 Power Dissipation vs. Ambient Temperature (Typical Value)



Material : Glass-cloth epoxy resin
 Size : 50×50×1.6mm
 Cu thickness : 35μm

Fig.19 Output Voltage Adjustment Characteristics



■ Setting of Output Voltage

Output voltage is able to set from 1.5V to 7V when resistors R₁ and R₂ are attached to ②, ③, ⑤ terminals. As for the external resistors to set output voltage, refer to the figure below and Fig.19.

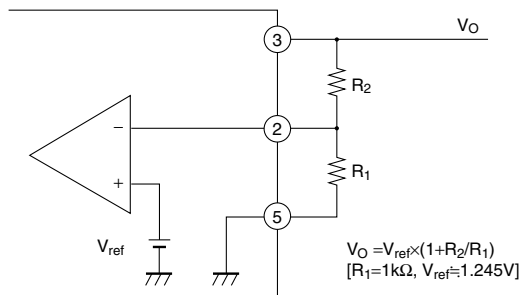

NOTICE

- The circuit application examples in this publication are provided to explain representative applications of SHARP devices and are not intended to guarantee any circuit design or license any intellectual property rights. SHARP takes no responsibility for any problems related to any intellectual property right of a third party resulting from the use of SHARP's devices.
- Contact SHARP in order to obtain the latest device specification sheets before using any SHARP device. SHARP reserves the right to make changes in the specifications, characteristics, data, materials, structure, and other contents described herein at any time without notice in order to improve design or reliability. Manufacturing locations are also subject to change without notice.
- Observe the following points when using any devices in this publication. SHARP takes no responsibility for damage caused by improper use of the devices which does not meet the conditions and absolute maximum ratings to be used specified in the relevant specification sheet nor meet the following conditions:
 - (i) The devices in this publication are designed for use in general electronic equipment designs such as:
 - Personal computers
 - Office automation equipment
 - Telecommunication equipment [terminal]
 - Test and measurement equipment
 - Industrial control
 - Audio visual equipment
 - Consumer electronics
 - (ii) Measures such as fail-safe function and redundant design should be taken to ensure reliability and safety when SHARP devices are used for or in connection with equipment that requires higher reliability such as:
 - Transportation control and safety equipment (i.e., aircraft, trains, automobiles, etc.)
 - Traffic signals
 - Gas leakage sensor breakers
 - Alarm equipment
 - Various safety devices, etc.
 - (iii) SHARP devices shall not be used for or in connection with equipment that requires an extremely high level of reliability and safety such as:
 - Space applications
 - Telecommunication equipment [trunk lines]
 - Nuclear power control equipment
 - Medical and other life support equipment (e.g., scuba).
- If the SHARP devices listed in this publication fall within the scope of strategic products described in the Foreign Exchange and Foreign Trade Law of Japan, it is necessary to obtain approval to export such SHARP devices.
- This publication is the proprietary product of SHARP and is copyrighted, with all rights reserved. Under the copyright laws, no part of this publication may be reproduced or transmitted in any form or by any means, electronic or mechanical, for any purpose, in whole or in part, without the express written permission of SHARP. Express written permission is also required before any use of this publication may be made by a third party.
- Contact and consult with a SHARP representative if there are any questions about the contents of this publication.