

1 2 3 4 5 6

A

B

C

D

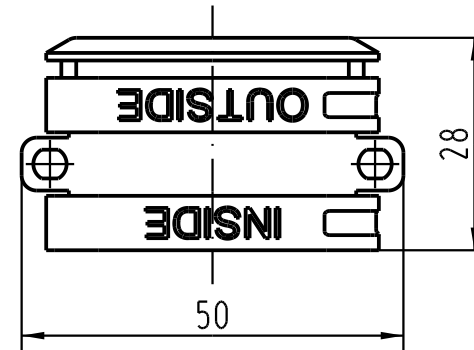
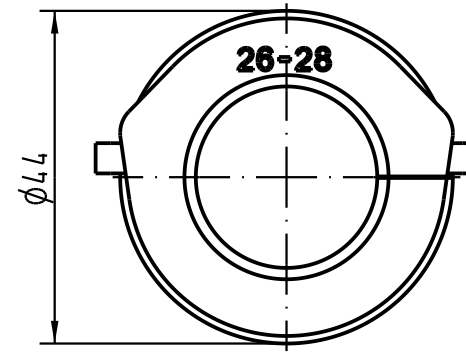

		All Dimensions in mm Original Size DIN A 4		Techn. Character.			Nicht tolerierte Masse/ Free size tolerances		
					Dat.	Name	Massstab/Scale		Kabeldichtung <i>cabl e sealing</i> 26-28mm
				Detail.	02.08.05	Loe.	1 : 1		
				Insp.		Be.			
				Stand.					
411733				HARTING Electric GmbH & Co. KG D-32339 Espelkamp					TB 11 30 000 9957
Mod.	Dat.	Name					Sub.		Blatt/ page