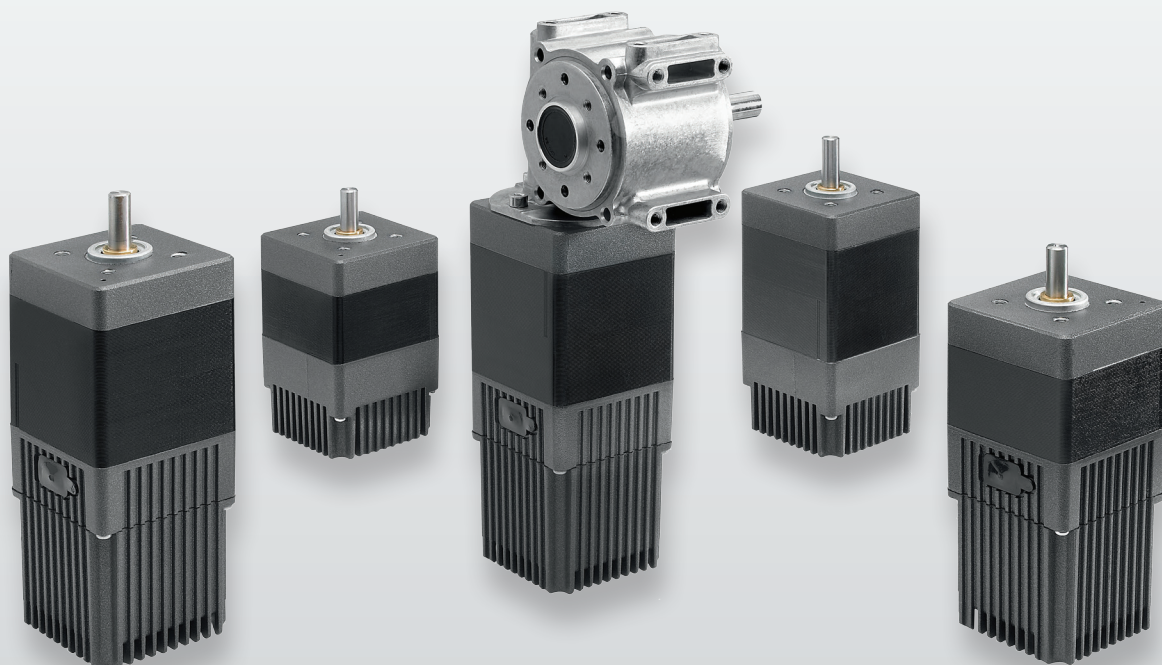


WWW.CROUZET-MOTORS.COM

# SMi21 DCMIND BRUSHLESS MOTORS

## USER AND SAFETY MANUAL



# SMi21 DCmind Brushless Motors

## User Manual and Safety Notice



### Important Notes

- This manual is part of the product.
- Read and follow the instructions in this manual.
- Keep this manual in a safe place.
- Give this manual and any other documents relating to the product to anyone that uses the product.
- Read and be sure to comply with all the safety instructions and the section "Before you Begin - Safety-Related Information".
- Please consult the latest catalogue to find out about the product's technical specifications.
- We reserve the right to make modifications without prior notification.

## Table of Contents

1.	Introduction .....	6
1.1.	Motor Family .....	6
1.2.	Characteristics .....	6
1.3.	Options .....	6
1.4.	Identification Label .....	6
1.5.	Product Coding .....	7
2.	Before you Begin - Safety-Related Information .....	8
2.1.	Personnel Qualifications .....	8
2.2.	Use in Compliance with Industry Practice.....	8
2.3.	Basic Information .....	9
2.4.	Standards and concepts .....	10
3.	Precautions for use concerning the mechanics.....	11
3.1.	Data specific to the motor shaft .....	11
3.1.1.	Press-fit force .....	11
3.1.2.	Radial load on the shaft.....	11
3.2.	Options.....	12
3.2.1.	Holding brake .....	12
3.2.2.	Gearboxes .....	12
3.2.3.	Other.....	12
4.	Accessories.....	12
4.1.	Starter Kit .....	12
5.	Installation.....	13
5.1.	Overview of the Installation Procedure .....	15
5.2.	Electromagnetic Compatibility (EMC) .....	15
5.3.	Prior to Mounting.....	16
5.4.	Mounting the Motor .....	17
5.5.	Electrical Installation .....	18
5.5.1.	Connecting the Holding Brake (Optional).....	20
5.6.	USB Connector .....	21
6.	operation.....	22
6.1.	Preparation for Operating.....	22
7.	Product overview .....	24
7.1.	Description of the Product.....	24
7.2.	SMi21 Control Electronics.....	24
7.3.	"DCmind-Soft" PC Parameter-Definition Software.....	25
8.	Technical Specifications .....	26
8.1.	Electrical Data .....	26
8.2.	Generic Data .....	26

- 8.3. Control Logic Bundle .....27
- 8.4. Power Supply Cable.....28
- 9. Motor electrical connection .....29
  - 9.1. Power Connection .....29
    - 9.1.1. Ballast Circuit.....29
    - 9.1.2. EMC Protection .....31
  - 9.2. Protection .....32
    - 9.2.1. Voltage Protection .....32
    - 9.2.2. Temperature Protection.....32
    - 9.2.3. Current Limiting .....32
  - 9.3. USB Connection.....33
  - 9.4. Input/Output Connection .....35
    - 9.4.1. Equivalent Input Diagram .....35
    - 9.4.2. Equivalent Output Diagram .....36
- 10. Installation of the DCmind-Soft HMI .....37
  - 10.1. Introduction.....37
  - 10.2. System Required.....37
  - 10.3. Installation of the USB Drivers .....37
  - 10.4. Installation of the Crouzet DCmind-Soft HMI .....38
  - 10.5. Description of the Main Window .....41
  - 10.6. Motor Connection.....43
  - 10.7. Updating the Firmware.....44
- 11. Application programs.....46
  - 11.1. Description .....46
  - 11.2. Description of the Monitoring Part.....48
  - 11.3. "Valve" Group.....49
    - 11.3.1. "Valve 4 positions" Application Program .....49
    - 11.3.2. "Valve 30 positions" Application Program with 1 Mechanical Stop .....51
  - 11.4. "Conveyor Belt" Group .....54
    - 11.4.1. "Conveyor Belt 0-10V" Application Program .....54
    - 11.4.2. "Conveyor Belt PWM" Application Program.....56
    - 11.4.3. « Conveyor with stop on detection » Application program .....58
  - 11.5. "Machine" Group .....60
    - 11.5.1. "Worm Gear" Application Program.....60
    - 11.5.2. "Worm Gear (Proportional)" Application Program.....63
    - 11.5.3. "Clamp" Application Program .....66
  - 11.6. « Dosing » group.....68
    - 11.6.1. Application program « Peristaltic pump ».....68
- 12. Expert programs .....70
  - 12.1. Speed Programs .....70
    - 12.1.1. Types of Inputs in V100 Programs .....70

12.1.2.	Types of Inputs in V200 Programs .....	70
12.1.3.	Types of Outputs in V100 Programs .....	71
12.1.4.	Type of outputs in V200 programs .....	71
12.1.5.	Description of the Various V100 and V200 Tabs .....	71
12.1.6.	Expert Program V101 .....	77
12.1.7.	Expert Program V102 .....	87
12.1.8.	Expert Program V103 .....	96
12.1.9.	Expert Program V104 .....	106
12.1.10.	Expert program V201 .....	116
12.1.11.	Expert program V202 .....	124
12.2.	Position Programs .....	132
12.2.1.	Types of Inputs in P100 Programs .....	132
12.2.2.	Types of Inputs in P200 Programs .....	133
12.2.3.	Types of Outputs in P100 and P200 Programs .....	134
12.2.4.	Description of the Different Types of Homing .....	135
12.2.5.	Description of the P100 Various Tabs .....	141
12.2.6.	Expert Program P101 .....	147
12.2.7.	Expert Program P111 .....	160
12.2.8.	Description of the P200 Various Tabs .....	172
12.2.9.	Expert Program P201 .....	178
12.2.10.	Expert Program P202 .....	192
12.3.	Torque Programs .....	206
12.3.1.	Types of Inputs in C100 Programs .....	206
12.3.2.	Types of Outputs in C100 Programs .....	206
12.3.3.	Description of the Various Tabs .....	207
12.3.4.	Expert Program C101 .....	211
13.	Saving Parameters .....	218
14.	Diagnostics and Troubleshooting .....	221
14.1.	Mechanical Failures .....	221
14.2.	Electrical Failures .....	221
15.	Service, maintenance and disposal .....	222
15.1.	Addresses of After-Sales Service Outlets .....	222
15.2.	Storage .....	222
15.3.	Maintenance .....	222
15.4.	Replacing the Motor .....	223
15.5.	Dispatch, Storage, Disposal .....	223
15.6.	Terminology and Abbreviations .....	224

## About This Manual

This manual applies to SMi21 DCmind brushless products:

- 801400SMi21, 801495SMi21, 801496SMi21, 801410SMi21
- 801800SMi21, 801896SMi21, 801897SMi21, 801810SMi21
- 802800SMi21, 802896SMi21, 802897SMi21, 802810SMi21

*Reference source for manuals*

The manuals can be downloaded from our website at the following address:

<http://www.crouzet.com/>

*Units*

SI units are the default values.

## Risk Categories

In this manual, safety instructions are identified by warning symbols.

Depending on how serious the situation is, the safety instructions are split into 3 risk categories.

 **DANGER**

DANGER indicates a directly dangerous situation which, if the instructions are not followed, will **inevitably** lead to a serious or fatal accident.

 **WARNING**

WARNING indicates a possibly dangerous situation which, if the instructions are not followed, will **in some cases** lead to a serious or fatal accident or cause damage to equipment.

 **CAUTION**

CAUTION indicates a potentially dangerous situation which, if the instructions are not followed, will **in some cases** lead to an accident or cause damage to equipment.

## 1. INTRODUCTION

### 1.1. Motor Family

SMi21 DCmind brushless motors are brushless DC motors, with a control circuit board integrated in the motor.

### 1.2. Characteristics

SMi21 DCmind brushless motors are intelligent servomotors for speed, position and torque control applications. They can be configured via a Human-Machine Interface (HMI). They are equipped with 2 unshielded cables as standard, 1 for the power, 1 for the control signals.

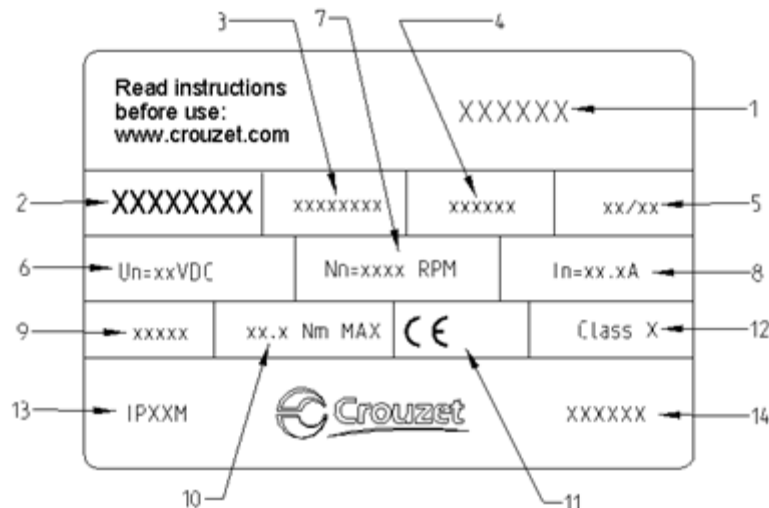
### 1.3. Options

The motors can be supplied with options, such as:

- Different gearboxes
- A failsafe holding brake
- Different motor output shaft versions

### 1.4. Identification Label

The label contains the following data:



1. Product family code.
2. Product part number.
3. Reserved zone.
4. Zone reserved for specific customer marking.
5. Week/year manufacturing date.
6. Operating voltage.
7. Nominal motor speed at 24 V.
8. Nominal motor current.
9. Reduction ratio (for geared motor versions).
10. Maximum nominal torque applicable to the gearbox (for geared motor versions).
11. Motor approvals.
12. Insulation system temperature class.
13. Product degree of protection (sealing) during operation (excluding output shaft).
14. Country of origin.

### 1.5. Product Coding

**80 XX XX SMi21:** Product family on SMi21 electronic base

PRODUCT REFERENCE	8 0	X X	X X	X X
Motor				
Type of stator:				
14: 30mm brushless stator				
18: 50 mm brushless stator				
28: 50 mm brushless stator high torque				
Gearbox adaptation				
00: no gearbox				
10: RAD10 gearbox				
95: P52 gearbox				
96: P62 gearbox				
97: P81 gearbox				
Increment numbers				



## **2. BEFORE YOU BEGIN - SAFETY-RELATED INFORMATION**

### **2.1. Personnel Qualifications**

Only qualified personnel who are familiar with and fully understand the contents of this manual are authorized to work on and with this product.

Qualified personnel must be familiar with current standards, regulations and requirements concerning prevention of accidents during work undertaken on and with this product.

These qualified personnel must have undergone safety training in order to be able to detect and avoid related hazards.

Their professional training, knowledge and experience renders such qualified personnel capable of preventing and recognizing potential hazards that might be generated through use of the product, modifying settings and the mechanical, electrical and electronic equipment in the whole installation.

### **2.2. Use in Compliance with Industry Practice**

As demonstrated in these instructions, this product is a component designed for use in industrial environments.

The current safety instructions, specified conditions and technical specifications must be complied with at all times.

Before starting to use the product, undertake a risk analysis using actual examples. Depending on the result, the necessary safety measures must be implemented.

Since the product is used as a component in an overall system, it is the user's responsibility to guarantee people's safety through the concept of the overall system (e.g. concept of a machine).

Only use original manufacturer accessories and spare parts.

The product must not be used in explosive atmospheres (Ex zone).

All other types of use are deemed to be non-compliant and can be dangerous.

Only qualified personnel are authorized to install, operate, maintain and repair electrical equipment.

### 2.3. Basic Information

 **DANGER****DANGEROUS PHENOMENON LINKED TO ELECTRIC SHOCK, EXPLOSION OR EXPLOSION DUE TO AN ELECTRIC ARC**

- Only qualified personnel who are familiar with and fully understand the contents of this manual are authorized to work on this product. Only qualified personnel are authorized to undertake installation, setting, repair and maintenance.
- The installation manufacturer is responsible for complying with all the applicable requirements and regulations with regard to grounding the drive system.
- It is the user's responsibility to define whether it is necessary to ground the motor, depending on its intended use.
- Do not touch unprotected live parts.
- Only use electrically-isolated tools.
- AC voltages can be connected to unused conductors in the motor cable. Isolate unused conductors at both ends of the motor cable.
- The motor produces a voltage when the shaft turns. Protect the motor shaft from any external drive operation before working on the drive system:
  - De-energize all connections.
  - Attach a notice saying "DO NOT START UP" on all the switches.
  - Protect all the switches from switching on.
  - Wait for the internal motor capacitors to discharge. Measure the voltage on the power cable and check that it is less than 12 VDC.
- Install protective covers and ensure they are closed before energization.

**Failure to comply with these precautions will result in death or serious injury.**

 **WARNING****LOSS OF COMMAND CONTROL**

- When perfecting the command concept, the installation manufacturer must take account of the possibilities for potential failure of command paths and provide, for certain critical functions, the means of returning to safe states during and after the failure of a command path.

Examples of critical command functions are:

EMERGENCY STOP, end position limiting, network outage and restarting.

- Separate or redundant command paths must be available for critical functions.
- Comply with the accident prevention instructions and all current safety directives.
- Any installation in which the product described in this manual has a central role must be carefully and meticulously checked prior to commissioning to ensure it is working properly.

**Failure to comply with these precautions can result in death or serious injury.**

 **WARNING****UNBRAKED MOVEMENT**

In the event of a power outage and errors resulting in disconnection of the power stage, the motor is no longer braked in a controlled way and can cause damage.

- Prevent access to the hazardous zone.
- If necessary, use a damped mechanical stop or a service brake.

**Failure to comply with these precautions can result in death, serious injury or damage to equipment.**

## 2.4. Standards and concepts


The product is ROHS confirmed following European Directive 2011/65/CE. Following this confirmation, the product is CE marked.

The electrical design follows the IEC 60335-1 and IEC 60950-1 standards.

### 3. PRECAUTIONS FOR USE CONCERNING THE MECHANICS

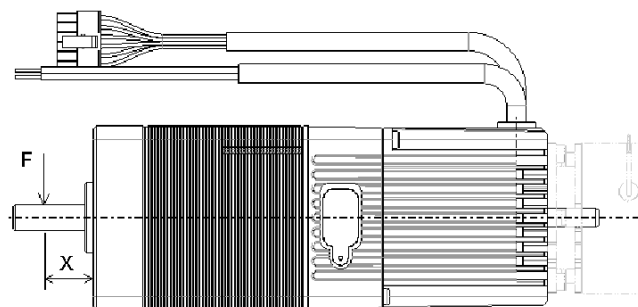
#### 3.1. Data specific to the motor shaft

##### 3.1.1. Press-fit force

 <b>WARNING</b>
<p><b>MOTOR MECHANISM</b>          Exceeding the maximum permissible forces on the shaft leads to rapid bearing wear, a broken shaft or damage to any accessories (encoder, brake, etc.)</p> <ul style="list-style-type: none"> <li>• Never exceed the maximum axial and radial forces.</li> <li>• Protect the shaft from any impact.</li> <li>• When press-fitting components, do not exceed the maximum permissible axial force.</li> </ul> <p><b>Failure to comply with these precautions can result in death, serious injury or damage to equipment.</b></p>

The maximum press-fit force is limited by the maximum permissible axial force on the ball bearings. This maximum axial force is stated in the motor technical data sheet. Alternatively, the component to be fixed in position can be clamped, glued or shrunk-fit.

##### 3.1.2. Radial load on the shaft



The application point  $X$  of the radial force  $F$  depends on the motor size. This information appears in the motor technical data sheet.

The maximum axial and radial loads must not be applied simultaneously.

## 3.2. Options

### 3.2.1. *Holding brake*

SMi21 DCmind brushless motors can be equipped as standard with a failsafe electromechanical brake. The holding brake is designed to lock the motor shaft in a de-energized state. The holding brake is not a safety function. How it is controlled is described in the "Connecting the Holding Brake" section.

### 3.2.2. *Gearboxes*

SMi21 DCmind brushless motors can be equipped with different types of gearbox. The gearboxes offered as standard in the catalogue are planetary gearboxes which combine compact size and robust design, and worm gearboxes that allow a shaft output at right-angles to the motor shaft.

### 3.2.3. *Other*

Other types of adaptation are possible on request, please contact the sales department.

## 4. ACCESSORIES

### 4.1. **Starter Kit**

This kit consists of a 2-meter long micro USB B to USB A (MOLEX 68784-0003) connecting cable and a USB stick containing the "Crouzet Interface" parameter-definition software and installation drivers for this HMI.

This starter kit can be obtained by ordering part number **79 298 008**.

## 5. INSTALLATION

Installation must, as a general rule, be performed in accordance with good practice.

 **WARNING****HEAVY WEIGHT AND FALLING PARTS**

The motor can be extremely heavy.

- When mounting, take the weight of the motor into account.
- Mounting (screw tightening torque) must be performed in such a way that the motor cannot become detached, even if subjected to strong accelerations or constant jolting.

**Failure to comply with these precautions can result in death, serious injury or damage to equipment.**

 **WARNING****STRONG ELECTROMAGNETIC FIELDS**

Motors can generate locally powerful electrical and magnetic fields. These can cause sensitive equipment to fail.

- Keep people with implants such as pacemakers away from the motor.
- Do not place sensitive equipment in the immediate vicinity of the motor.

**Failure to comply with these precautions can result in death, serious injury or damage to equipment.**

 **WARNING****UNEXPECTED BEHAVIOR CAUSED BY DAMAGE OR FOREIGN BODIES**

Following damage to the product or the presence of foreign bodies, deposits or penetration of fluid, unexpected behavior can occur.

- Do not use damaged products.
- Make sure that no foreign body has been able to penetrate the product.
- Check that the power supply lead seals and cable entries have been positioned correctly.
- Check that the stopper protecting the USB B to USB A micro connector has been positioned correctly.

**Failure to comply with these precautions can result in death, serious injury or damage to equipment.**

 **WARNING****HOT SURFACES**

The product's metal surface can heat up to more than 70°C in certain types of use.

- Avoid all contact with the metal surface.
- Do not place flammable or heat-sensitive components in the immediate vicinity.
- Assemble components in the best way for heat dissipation.

**Failure to comply with these precautions can result in injury or damage to equipment.**

 **WARNING****DAMAGE AND DESTRUCTION OF THE MOTOR CAUSED BY STRESS**

The motor is not designed to carry loads. If subjected to stress, the motor can be damaged, or even fall.

- Do not use the motor as a step.
- Prevent the motor from being used in any way other than its intended purpose by installing guards or displaying safety instructions.

**Failure to comply with these precautions can result in injury or damage to equipment.**

 **CAUTION****VOLTAGE SURGES**

During braking phases, the motor generates voltage surges.

- Check that these voltage surges are acceptable to other devices connected on the same power supply.
- If possible, use an external circuit to limit voltage surges. if the brake is used intensively.

**Failure to comply with these precautions can result in injury or damage to equipment.**


## 5.1. Overview of the Installation Procedure

The installation procedure is described in the following sections:

- Electromagnetic Compatibility (EMC)
- Prior to Mounting
- Mounting the Motor
- Electrical Installation
- Connecting the USB cable to Set the Motor Parameters

Check that these sections have been read and understood, and that installation has subsequently been executed correctly.

## 5.2. Electromagnetic Compatibility (EMC)

 **DANGER**

**INTERFERENCE AFFECTING SIGNALS AND EQUIPMENT**  
 Disturbed signals can cause equipment to behave unpredictably.

- Wire up products in compliance with the specific EMC recommendations for each device.
- Make sure that these EMC recommendations are executed correctly.

**Failure to comply with these precautions can result in death, serious injury or damage to equipment.**

*Recommendations in terms of EMC: Installing the motor power supply leads*

When planning the wiring, take account of the fact that the motor power supply leads must be kept separate from line supplies or cables carrying signals.

Comply with the following measures as concerns EMC.

Measures relating to EMC	Effect
Keep the cables as short as possible. Do not install unnecessary cable loops.	Reduces stray couplings, both capacitive and inductive.
Ground the product.	Reduces emissions, improves immunity to interference.
If using shielded cables, install the cable shielding so that it is in contact with the widest possible surface area, use cable grips and ground strips.	Reduces emissions.
Keep the motor power supply leads separate from cables carrying signals or use shielding plates.	Reduces stray cross-couplings.
If using shielded cables, install the cables without any disconnection points. <sup>1)</sup>	Reduces stray radiation.

<sup>1)</sup> When a cable is disconnected for installation, the cables must be connected at the disconnection point via a shielding connection and a metal box.



#### *Equipotential bonding conductors*

If using shielded cables, differences in potential can generate unauthorized currents on the cable shielding. Use equipotential bonding conductors to minimize currents on the cable shielding.

### 5.3. Prior to Mounting

#### *Look for any damage*

Damaged drive systems must neither be mounted nor used.

⇒ Check the drive system prior to mounting, looking out for any visible signs of damage.

#### *Clean the shaft*

On leaving the factory, the motor shaft extensions are coated with a film of oil.

If transmission devices are to be glued on, it may be necessary to remove the film of oil and clean the shaft. If necessary, use degreasing products in accordance with the glue manufacturer's instructions.

⇒ Avoid any direct contact between the skin or sealing materials and the cleaning product used.

#### *Flange mounting surface*

The mounting surface must be stable, flat and clean.

⇒ In regards to installation, make sure that all dimensions and tolerances are respected.

#### *Specification of power supply leads*

The power supply leads for the motor and its accessories must be selected carefully on the basis of their length, the motor supply voltage, the ambient temperature, the current level circulating therein, and their environment.



## WARNING

#### **DAMAGE AND FIRE DUE TO INCORRECT INSTALLATION**

Repeated force and movement around the grommets can damage the cables.

- Comply with the stated bend radius.
- Avoid subjecting the grommets to repeated force or movement.
- Attach the power supply cables close to the grommets using a strain relief.

**Failure to comply with these precautions can result in injury or damage to equipment.**

## 5.4. Mounting the Motor

 **DANGER****HOT SURFACES**

The motor's surface can heat up to more than 70°C in certain types of use.

- Avoid contact with hot surfaces.
- Do not place flammable or heat-sensitive components in the immediate vicinity.
- Assemble components in the best way for heat dissipation.
- Check the temperature when performing a test.

**Failure to comply with these precautions can result in injury or damage to equipment.**

 **WARNING****UNEXPECTED MOVEMENT DUE TO ELECTROSTATIC DISCHARGES**

Electrostatic discharges (ESD) on the shaft can, in rare cases, lead to encoder system failures and generate unexpected motor movements.

- Use conductive parts (e.g. antistatic straps) or other appropriate measures to avoid a static charge due to movement.

**Failure to comply with these precautions can result in death, serious injury or damage to equipment.**

 **WARNING****UNINTENDED BEHAVIOR CAUSED BY MECHANICAL DAMAGE TO THE MOTOR**

Exceeding the maximum permissible forces leads to rapid bearing wear, a broken shaft or damage to the internal encoder.

- Never exceed the maximum axial and radial forces.
- Protect the shaft from any impact.
- When press-fitting components, do not exceed the maximum permissible axial force.

**Failure to comply with these precautions can result in death, serious injury or damage to equipment.**

### Mounting position

The motor can be mounted in any position.

### Mounting

When mounting the motor on the flange, the motor must be aligned precisely in both the axial and radial directions. All the fixing screws must be tightened to the tightening torque stipulated by the application, taking care not to generate any warping.

### Install the transmission devices

If the transmission device is installed incorrectly, this can damage the motor.

Transmission devices such as pulleys and gears must be mounted in compliance with the maximum axial and radial loads defined in each motor's technical data sheet.

Follow the transmission device manufacturer's assembly instructions.

The motor and the transmission device must be aligned precisely both axially and radially. If this is not done, it will result in abnormal operation, damage to the bearings and significant wear.

## 5.5. Electrical Installation

These motors are not designed to be connected directly to the line supply.

It is the installer's responsibility to define the electrical protection devices to be implemented according to the regulations applicable to the end product range of application.

For the power supply to the power part we recommend using a double-insulated stabilized power supply.

The motor is not protected against polarity reversals on the power part.

The motor is regenerative, in other words it can feed back energy to the power supply during braking phases. Voltage surges created in this way can reach levels that risk destroying the motor itself or devices placed on the same power supply.

### DANGER

#### ELECTRIC SHOCK

High voltages can appear unexpectedly on the motor connection.

- The motor produces a voltage when the shaft turns. Protect the motor shaft from any external drive operation before working on the drive system.

- The system manufacturer is responsible for complying with all applicable regulations with regard to grounding the drive system.

**Failure to comply with these precautions will result in death or serious injury.**

### WARNING

#### UNEXPECTED MOVEMENT

As a result of incorrect wiring or other error, the drives can execute unexpected movements.

- Do not start up the installation if there is anybody or any obstacle in the danger zone.

- Execute the initial test movements without loads connected.

- Do not touch the motor shaft or related drive elements.

**Failure to comply with these precautions can result in death, serious injury or damage to equipment.**

 **WARNING****VOLTAGE SURGES**

During braking phases, the motor generates voltage surges.

- Check that these voltage surges are acceptable to other devices connected on the same power supply.
- If possible, use an external circuit to limit voltage surges if the brake is used intensively.

**Failure to comply with these precautions can result in death, serious injury or damage to equipment.**

 **CAUTION****FIRE CAUSED BY BAD CONTACTS**

If the connector is not properly inserted the motor connector can overheat, causing the contacts to melt due to an electric arc.

- Incorrect connection can cause overheating due to an electric arc.

**Failure to comply with these precautions can result in injury or damage to equipment.**

 **CAUTION****IRREPARABLE PRODUCT DAMAGE CAUSED BY REVERSED POLARITY**

Incorrect connection of the power can result in reversed polarity, resulting in destruction of the circuit board inside the motor.

- Check the conformity of the power connections.
- Place a slow-blow fuse on the power supply that is appropriately sized for the current the motor needs to absorb in the application.

**Failure to comply with these precautions can result in injury or damage to equipment.**

*Connecting the protection conductor*

It is the installer's responsibility to define whether the motor needs to be grounded.

The mounting flange should be used for this purpose.

Never connect or disconnect the product power supply leads while the voltage is applied.

### 5.5.1. Connecting the Holding Brake (Optional)

 **WARNING**

**LOSS OF BRAKING FORCE DUE TO WEAR OR HIGH TEMPERATURE**  
Engaging the holding brake while the motor is running leads to rapid wear and loss of braking force.

- Do not use the brake as a service brake.
- Note that "emergency stops" can also cause wear.

**Failure to comply with these precautions can result in death, serious injury or damage to equipment.**

 **WARNING**

**UNEXPECTED MOVEMENT**  
Releasing the holding brake can result in unexpected movement on the installation.

- Make sure this cannot cause any damage.
- Do not continue with the test if there is anybody or any obstacle in the danger zone.

**Failure to comply with these precautions can result in death, serious injury or damage to equipment.**

 **CAUTION**

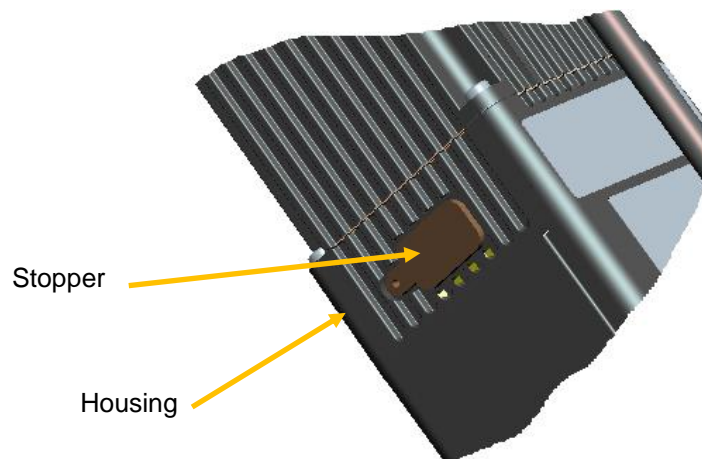
**MALFUNCTION OF THE HOLDING BRAKE DUE TO INAPPROPRIATE VOLTAGE**

- If the voltage is too low, the holding brake cannot release, resulting in wear.
- In the event of voltages higher than the specified value, the holding brake will be subject to significant overheating.

**Failure to comply with these precautions can result in injury or damage to equipment.**

A motor with a holding brake needs a corresponding control logic which releases the holding brake at the start of the rotation movement, locking the motor shaft in time when the motor stops.

## 5.6. USB Connector



The motor is equipped with a USB B to USB A micro connector, which can be accessed by removing the stopper from the housing.

The stopper prevents penetration of foreign bodies or fluids inside the motor.

The stopper prevents fingers or any inappropriate object making contact with the USB B to USB A micro connector.

It must be replaced carefully after use, in order to keep the motor sealed.

### **WARNING**

#### **UNEXPECTED MOVEMENT DUE TO ELECTROSTATIC DISCHARGES**

Electrostatic discharges (ESD) on the USB B to USB A micro connector can, in some cases, lead to deterioration or destruction of some system components and generate unexpected motor operation.

- Never touch the connector with your fingers or any inappropriate object.

**Failure to comply with these precautions can result in death, serious injury or damage to equipment.**

### **CAUTION**

#### **LOSS OF SEALING**

The stopper ensures the motor is sealed.

- Replace it after completing parameter definition.
- Make a visual check to ensure it is in place.

**Failure to comply with these precautions can result in injury or damage to equipment.**

## 6. OPERATION

### 6.1. Preparation for Operating

Prior to operating:

- ⇒ Check that the mechanical installation is correct.
- ⇒ Check that the electrical installation has been carried out professionally: pay special attention to the protective conductor connections and the grounding connections. Check that all the junctions are correct, properly connected and that the screws are fully tightened.
- ⇒ Check the ambient conditions and operating conditions: make sure that the stipulated ambient conditions are adhered to and that the drive solution conforms to the expected operating conditions.
- ⇒ Check that any transmission devices that are already mounted are balanced and aligned precisely.
- ⇒ Check that the operating conditions do not generate abnormal voltage surges for the product or the application.
- ⇒ Check that the holding brake can withstand the maximum load. After applying the braking voltage, make sure that the holding brake is fully released. Make sure that the holding brake is fully released before initiating a movement.
- ⇒ Check that the USB micro connector's protective stopper has been replaced correctly.

 **WARNING****UNEXPECTED MOVEMENT**

As a result of incorrect wiring or other error, the drives can execute unexpected movements.

- Check the wiring.
- Do not start up the installation if there is anybody or any obstacle in the danger zone.
- Execute the initial test movements without loads connected.
- Do not touch the motor shaft or related drive elements.

**Failure to comply with these precautions can result in death, serious injury or damage to equipment.**

 **WARNING****ROTATING PARTS**

Rotating parts can cause injuries, trap clothing or hair. Separate parts or unbalanced parts can be ejected.

- Check that all rotating parts are fitted properly.
- Use a protective cover for rotating parts.

**Failure to comply with these precautions can result in death, serious injury or damage to equipment.**

 **WARNING****FALLING PARTS**

The motor can move due to the reaction torque; it can topple over and fall.

- Fix the motor firmly in place so that it cannot become detached during rapid acceleration.

**Failure to comply with these precautions can result in death, serious injury or damage to equipment.**

**CAUTION****HOT SURFACES**

The motor's surface can heat up to more than 70°C in certain types of use.

- Avoid contact with hot surfaces.
- Do not place flammable or heat-sensitive components in the immediate vicinity.
- Assemble components in the best way for heat dissipation.
- Check the temperature when performing a test.

**Failure to comply with these precautions can result in injury or damage to equipment.**

**CAUTION****VOLTAGE SURGES**

During braking phases, the motor generates voltage surges.

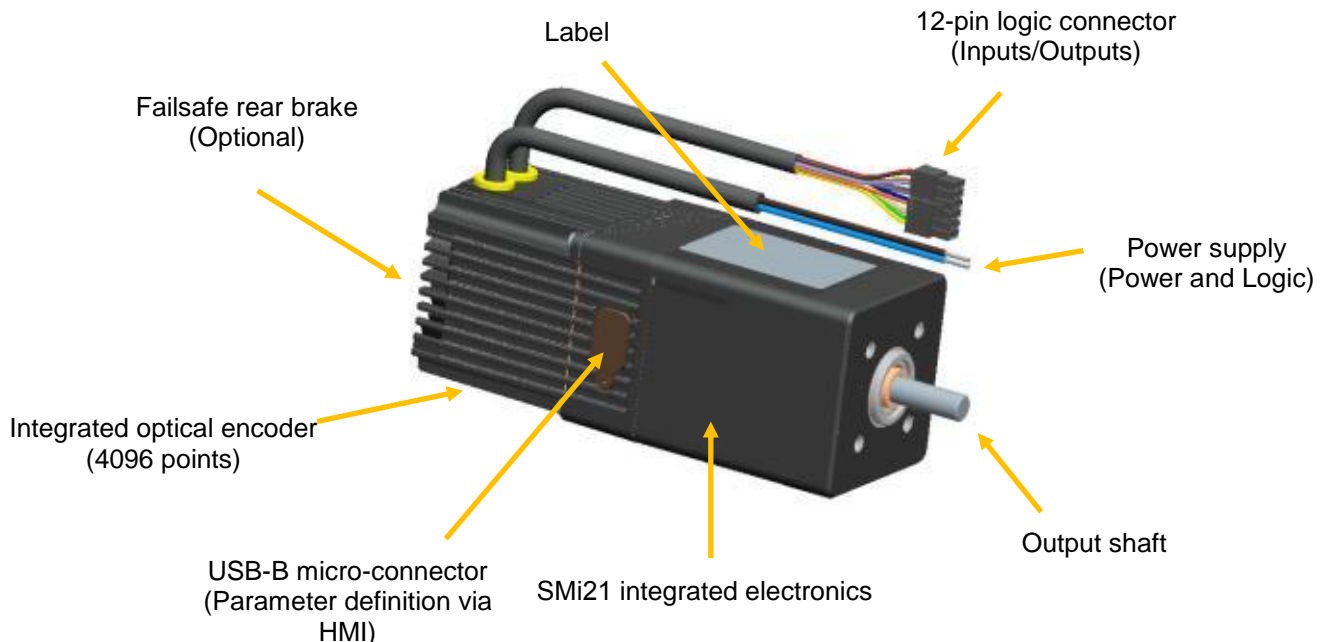
- Check that these voltage surges are acceptable to other devices connected on the same power supply.
- If possible, use an external circuit to limit voltage surges if the brake is used intensively.

**Failure to comply with these precautions can result in injury or damage to equipment.**



## 7. PRODUCT OVERVIEW

### 7.1. Description of the Product



**Figure 1**

### 7.2. SMi21 Control Electronics

The SMi21 electronic control card contains the control electronics for a brushless motor, integrated in the motor body.

This electronics is used for:

- Power switching of the motor in sine mode (field-oriented control (FOC)).
- Position-Speed-Torque and Current control algorithms.
- Use of preconfigured programs which can perform numerous routine applications.
- Management of different types of operation:
  - "Stand-alone" motor without external PLC.
  - Use with other motors incorporating SMi21 or TNI21 or Motomate electronics.
  - Use with a programmable controller, with the SMi21 simplifying motor management.
- The interface with parameter-definition software installed on the PC:
  - Easy to use, even by a layman, thanks to simplified application programs that are quick to get up and running.
  - Wide choice of expert programs covering a wide range of applications.
  - USB connection via a commercially-available standard cable (can be supplied on request).
- Management of 6 inputs and 4 outputs to control the motor:
  - 2 inputs that can be configured for 0-10 V 10-bit analog or PWM or digital control
  - 4 digital inputs
  - 1 output that can be configured as PWM or frequency or digital
  - 1 output that can be configured as PWM or digital
  - 2 digital outputs

As standard, the motors have an internal encoder with 4096 points per revolution that can reach high positioning and control resolutions.

### 7.3. "DCmind-Soft" PC Parameter-Definition Software

This software can be downloaded from the Internet at the following address: <http://www.crouzet.com/>.  
It can also be supplied as a kit, see "Programming Kit" section.

This "DCmind-Soft" software is needed the first time the motor is used and for debugging.

It is used for:

- Selecting the motor operating program:
  - Position
  - Speed
  - Torque
  - Quick and easy starting using preprogrammed applications.
  - Use of "expert" programs that provide access to all settings.
- The various settings needed for the application to work correctly.
- Updating the "firmware" motor program using the bootloader function.

## 8. TECHNICAL SPECIFICATIONS

### 8.1. Electrical Data

Maximum Product Specifications				
Parameters	Value			Unit
Supply voltage $V_{DC\ MAX}$	60			V
Maximum current $I_{DC\ MAX}$	20			A
Maximum input voltage $V_{IN\ MAX}$	50			V
Maximum output voltage $V_{OUT\ MAX}$	60			V
Maximum output current $I_{OUT\ MAX}$	50			mA
Operating Specifications				
Parameters	Min	Typical	Max	Unit
Supply voltage $V_{DC}$	9	12 / 24 / 48	56	V
Current $I_{DC}$	-	10	17	A
Motor consumption when stopped without holding $W_0$	-	1	-	W
Input Specifications				
Parameters	Min	Typical	Max	Unit
Input impedance In1 to In4 $R_{IN\_DIG}$	-	57	-	$\Omega$
Input impedance I5 to I6 $R_{IN\_ANA/PWM}$	-	69	-	$\Omega$
Low logic level on inputs In1 to In4 $V_{IL\_DIG}$	0	-	2	V
High logic level on inputs In1 to In4 $V_{IH\_DIG}$	4	-	50	V
Low logic level on inputs I5 to I6 $V_{IL\_PWM}$	0	-	2	V
High logic level on inputs I5 to I6 $V_{IH\_PWM}$	7.5	-	50	V
Output Specifications				
Parameters	Min	Typical	Max	Unit
Low logic level on outputs Out1 to Out4 $V_{OL}$ $R_L = 4\ K7\Omega, V_{DC} = 24\ V$	0	-	0.2	V
High logic level on outputs Out1 to Out4 $V_{OL}$ $R_L = 4\ K7\Omega, V_{DC} = 24\ V$	VDC – 0.5 V	-	VDC	V
PNP open collector type				

### 8.2. Generic Data

General Specifications		
Parameters	Value	Unit
Ambient motor temperature	-30 to +70	°C
Insulation class (compliant with directive IEC 60085)	E	/
Ingress protection (excluding output shaft)	IP65M	/

### 8.3. Control Logic Bundle

This consists of a UL approved cable Style 2464 80°C 300 V, 500 mm long as standard, fitted with a 12-pin MOLEX connector part number [43025-1200](#):

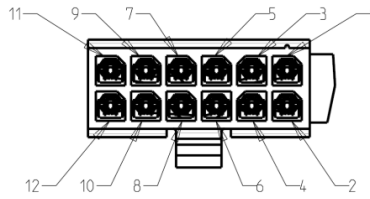


Figure 2

Pin	Type	Wire Color (AWG24)
1	Input no. 1 – Digital	Green
2	Input no. 2 – Digital	Yellow
3	Input no. 3 – Digital	White
4	Input no. 4 – Digital	White/Brown
5	Input no. 5 – Analog setpoint or PWM (or Digital)	Blue
6	Input no. 6 – Analog setpoint or PWM (or Digital)	Orange
7	Logic ground - 0 VDC	Black
8	Logic ground - 0 VDC	White/Black
9	Output no. 1 – Digital or PWM	Brown
10	Output no. 2 – Digital or PWM	Purple
11	Output no. 3 – Digital	Red
12	Output no. 4 – Digital	Gray

A label attached to the motor summarizes this information:

POWER CABLE		
BROWN	+ 24 Vdc	
BLUE	POWER GROUND	
COMMAND CABLE		
1	E1 - IN	GREEN
2	E2 - IN	YELLOW
3	E3 - IN	WHITE
4	E4 - IN	WHITE-BROWN
5	E5 - IN	BLUE
6	E6 - IN	ORANGE
7	GND	BLACK
8	GND	WHITE-BLACK
9	S1 - OUT	BROWN
10	S2 - OUT	PURPLE
11	S3 - OUT	RED
12	S4 - OUT	GREY




Figure 3

Connector part numbers to be used for connection:

On a card: MOLEX series 43045

On a cable: MOLEX series 43020

With cables more than 3 m long, tests must be performed in situ.

#### 8.4. Power Supply Cable

Type	Wire Color (AWG16)
Power supply: 12 VDC → 48 VDC	Brown
Power ground: 0 VDC	Blue

The power supply cable is UL approved Style 2517 105°C 300 V, 500 mm long as standard.

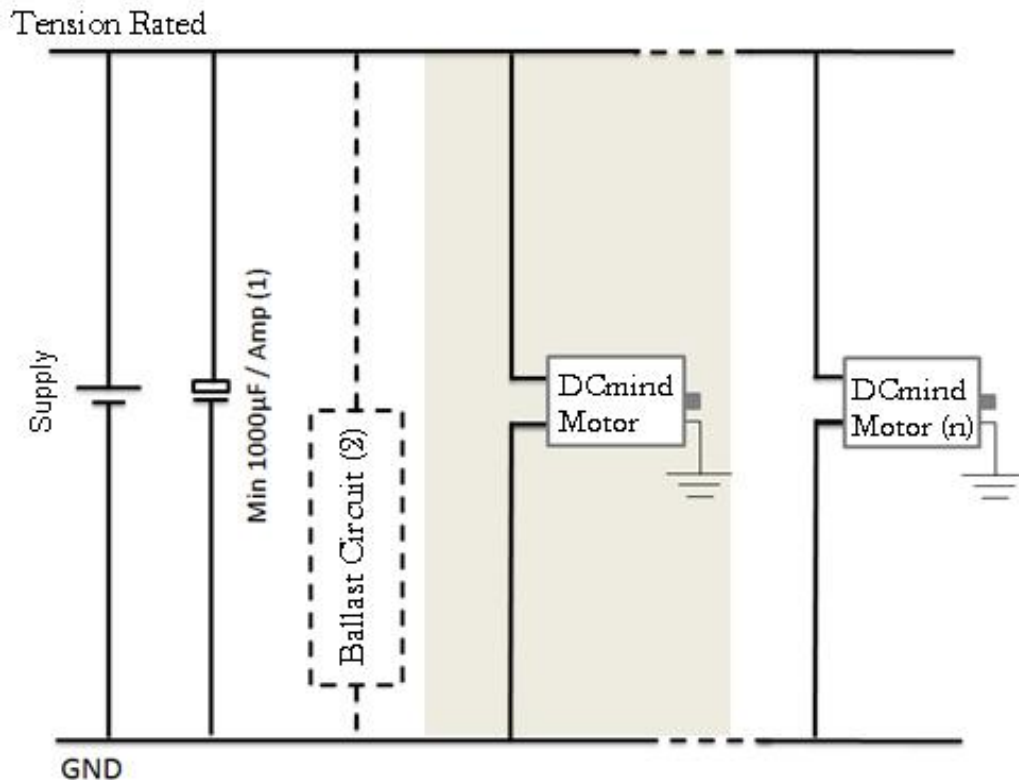
When a cable extension is used, the cable cross-section size should depend on the current drawn and the cable length.

## 9. MOTOR ELECTRICAL CONNECTION

### 9.1. Power Connection

We recommend grounding the motor housing.

*Power connection diagram.*



**Figure 4**

- <sup>(1)</sup> Include capacitors to smooth out inrush currents. Recommended value 1000  $\mu\text{F}/\text{A}$  drawn.
- <sup>(2)</sup> Optional. The ballast circuit eliminates voltage surges produced when braking. See next section.

**The product is not protected against polarity reversals on the power cable.  
A polarity reversal can damage the product irreversibly.**

#### 9.1.1. Ballast Circuit

When the motor brakes, the kinetic energy stored in the inertias during rotation is returned to the power supply and generates a voltage surge. This voltage surge can be destructive for the motor or for devices connected to the power supply.

In the event of frequent braking, **an external ballast circuit must be used.**

It is always necessary to conduct tests to check what size it should be.

9.1.1.1. Proposed Ballast Circuit Diagram

The diagram below allows the braking energy to be dissipated into a resistor, thus limiting voltage surges at the motor terminals.

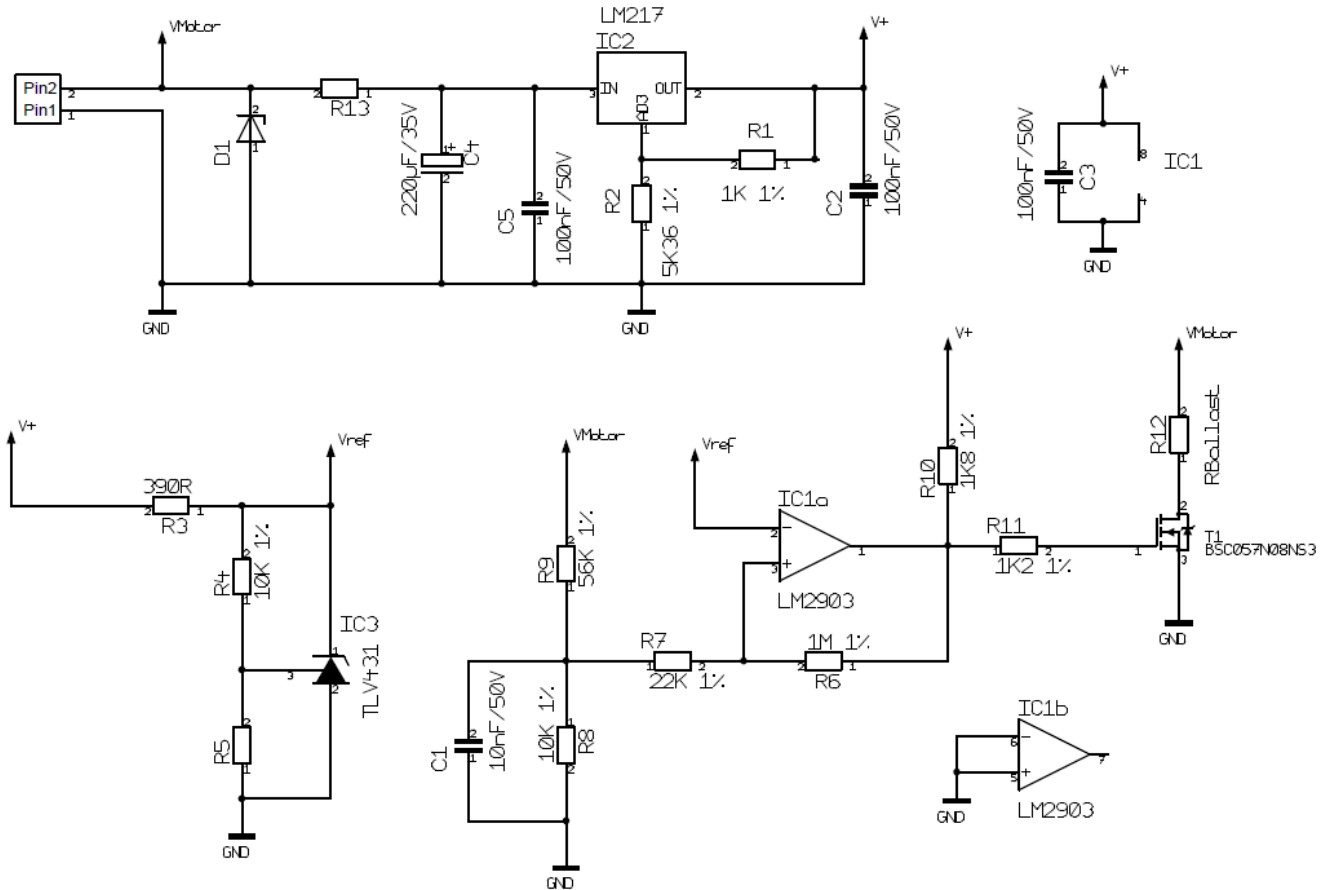


Figure 5

9.1.1.2. Determining the Size of the R12 Resistor (R<sub>Ballast</sub>)

The higher the braking current, the lower the resistor value. Typical values are around several Ohms. With V the rotation speed in revolutions per minute and J the inertia in Kg.m<sup>2</sup>, the energy E in Joules stored in the inertia is given by:

$$E = \frac{\pi^2}{1800} \times J \times V^2$$

If t is the braking duration in seconds, the power P1 dissipated during this time will be:

$$P1 = \frac{E}{t}$$

Note: The time t is set via the value of the deceleration ramps in the HMI.

If T is the time interval between 2 braking operations in seconds, the dissipated power P2 will be:

$$P2 = \frac{P1}{T}$$

The resistor should be large enough to dissipate the power P2 while tolerating peaks at P1.

It should be noted however that this is a simplified and somewhat pessimistic calculation since it does not take account of the energy stored in the capacitors, nor that lost during friction, the gearbox, etc.

### 9.1.1.3. Voltage Breaking Capacity Selection

The voltage breaking capacity should be selected:

- Depending on the power supply
- Depending on the other devices connected to this power supply

If your power supply does not tolerate current feedback, place a diode in series upstream of the ballast circuit to protect it.

The voltage breaking capacity usually selected is between +10% and +20% of the supply voltage.  
E.g.: For 24 VDC the voltage breaking capacity would be 28 VDC.

List of components for the usual operating voltages:

Nominal voltage	12V	24V	32V	48V
Voltage breaking capacity	14V	28V	36V	52V
D1	SMBJ14A	SMBJ28A	SMBJ36A	SMBJ54A
R13	0R	560R 0.5W	1K 1W	2K2 2W
R5	15K 1%	4K32 1%	3K09 1%	1K95 1%

### 9.1.2. EMC Protection

In order to ensure that the product is compatible with EMC standards IEC 61000-6-1, IEC 61000-6-2, IEC 61000-6-3, IEC 61000-6-4, we recommend:

- Connecting the motor to ground while limiting length of the grounding strip,
- Adding capacitors on the main power supply.  
We recommend 1000  $\mu$ F per amp drawn.



## 9.2. Protection

 **DANGER****PROTECTION**

The product has internal protection devices that switch off the motor power supply when activated. As the motor is no longer controlled, driving loads can decrease.

- The system manufacturer is responsible for complying with all the applicable safety rules in the event of product failure.

**Failure to comply with these precautions will result in death or serious injury.**

### 9.2.1. Voltage Protection

The product incorporates protection against voltage surges and undervoltages.

Protection against voltage surges:

The voltage surge threshold can be set in the HMI between 12 and 57 V (set at 57 V by default).

When the supply voltage exceeds the threshold, the product automatically switches to ERROR mode. In ERROR mode the motor is no longer controlled.

To reset the motor:

- The supply voltage must be at least 1 V below the threshold value.
- The motor inputs must be set to STOP mode.

Protection against undervoltages:

When the supply voltage falls below 8 V, the product automatically switches to ERROR mode. In ERROR mode the motor is no longer controlled.

To reset the motor:

- The supply voltage must be higher than 9 V.
- The motor inputs must be set to STOP mode.

### 9.2.2. Temperature Protection

The product incorporates temperature protection in the form of a temperature sensor on the motor pilot control card.

Temperature protection:

When the internal temperature exceeds 110°C, the product automatically switches to ERROR mode. In ERROR mode the motor is no longer controlled.

To reset the motor:

- The temperature must be less than 90°C.
- The motor inputs must be set to STOP mode.

### 9.2.3. Current Limiting

The product incorporates internal current limiting. This limiting directly affects the motor in terms of hardware. This limiting automatically restricts the current to 17 A in the motor phases. If this limit is reached, it results in a loss of motor performance.

This product is not designed to operate continuously with this limiting (see the "Electrical Data" section).

### 9.3. USB Connection

USB connection requires a type B micro-USB socket on the motor.

The cable must be less than 3 m long.

Possible cable part number: MOLEX 68784-0003.

#### Connection procedure

- Carefully remove the black stopper from the motor to reveal the Micro USB-B connector. The stopper has a retainer to keep it attached to the motor.



**Figure 6**



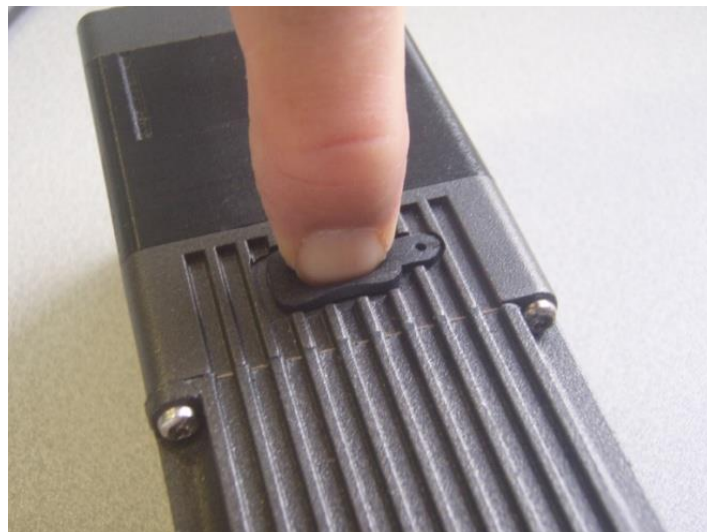
**Figure 7**

- Insert the USB cable and install the drivers as instructed.

Take care never to touch the connector or contacts inside the motor with your fingers or any inappropriate object.

Once finished, it is essential to replace the stopper carefully, to maintain the motor seal and protect the connector from any contact.

Simply pressing your finger in the middle of the stopper will close it properly.



**Figure 8**

**Incorrect stopper fitting**

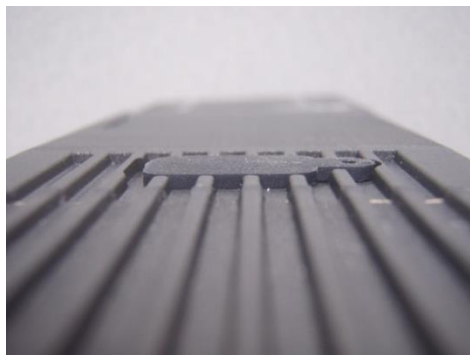


**Figure 9**



**Figure 10**

**Correct stopper fitting**



**Figure 11**

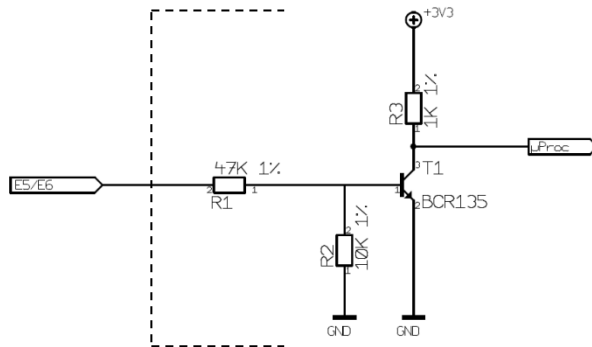


**Figure 12**

## 9.4. Input/Output Connection

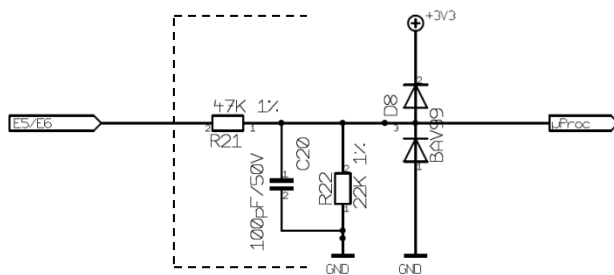
### 9.4.1. Equivalent Input Diagram

NPN digital inputs



**Figure 13**

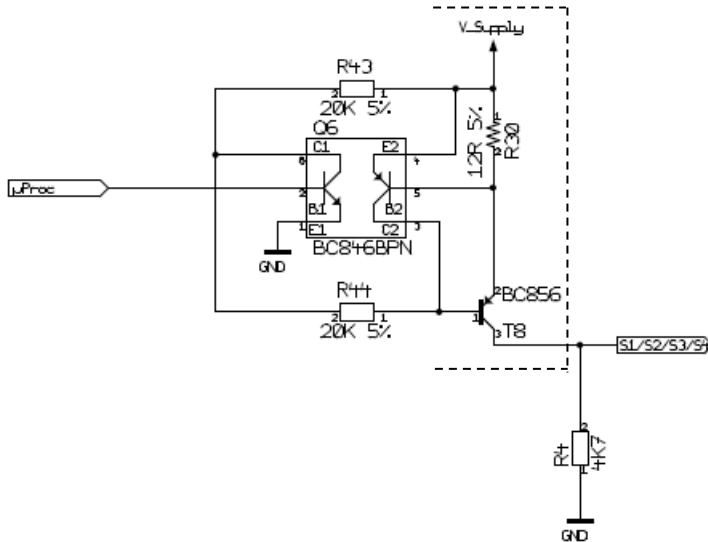
Analog/PWM/digital inputs



**Figure 14**

9.4.2. Equivalent Output Diagram

PNP outputs with max. 50 mA open collector.  
Include a pull down resistor (recommended value 4.7 kΩ).



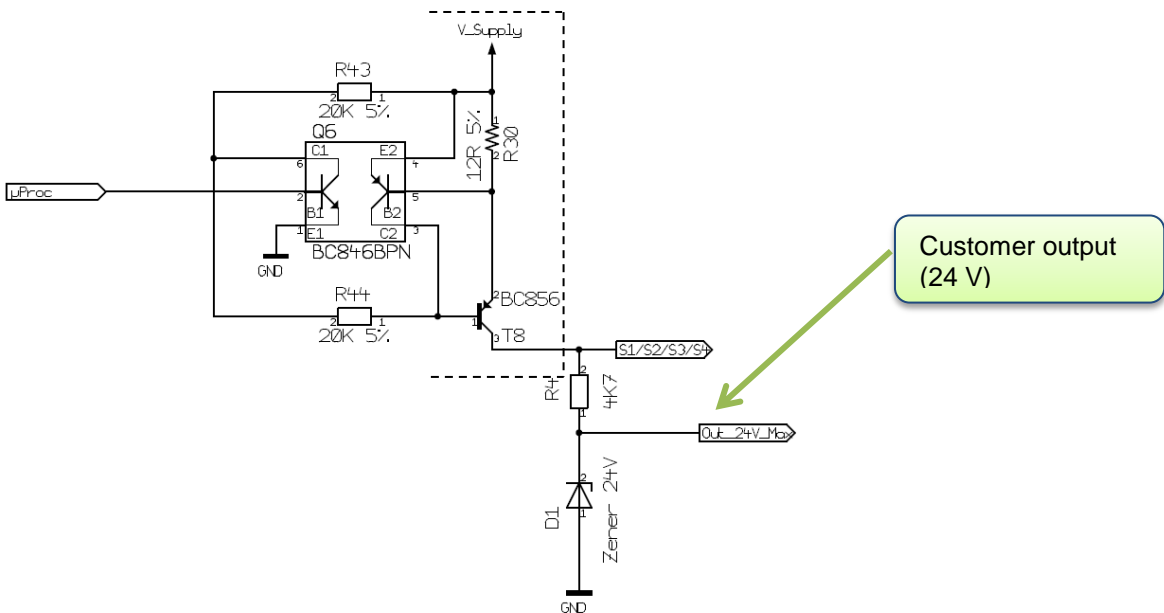
**Figure 15**

**Caution:** The output level is the same as the motor supply voltage:

if V DC = 48V then Out1/Out2/Out3/Out4 = 48 V.

In the event of rejection, this voltage increases accordingly, and can rise up to 57 V maximum (voltage threshold value).

If your application necessitates limiting the voltage value of these outputs, implement the diagram below.



## 10. INSTALLATION OF THE DCMIND-SOFT HMI

### 10.1. Introduction

To configure motors in the SMi21 DCmind Brushless range, Crouzet provides a user-friendly HMI that is easy to use. By means of a communication interface, the HMI establishes the connection between the PC and the motor and can be used to configure the motor and adapt its operation to the application.

### 10.2. System Required

The HMI is compatible with the following operating systems:

- Windows XP Family & Professional (with Framework version 3.5 minimum: supplied on USB stick)
- Windows Vista
- Windows 7 (32 & 64-bit)

The HMI installation files are supplied on the USB stick in the programming kit and are available for download from the Internet at the following address: <http://www.crouzet.com/>

### 10.3. Installation of the USB Drivers

Run the "*Driver Motor.exe*" file in the "Driver" folder:



**Figure 16**

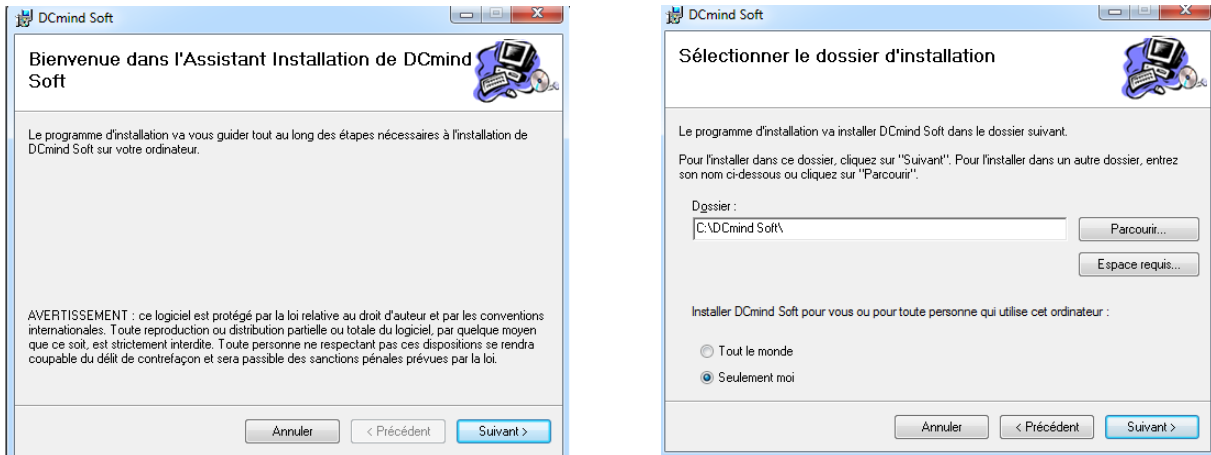


**Figure 17**

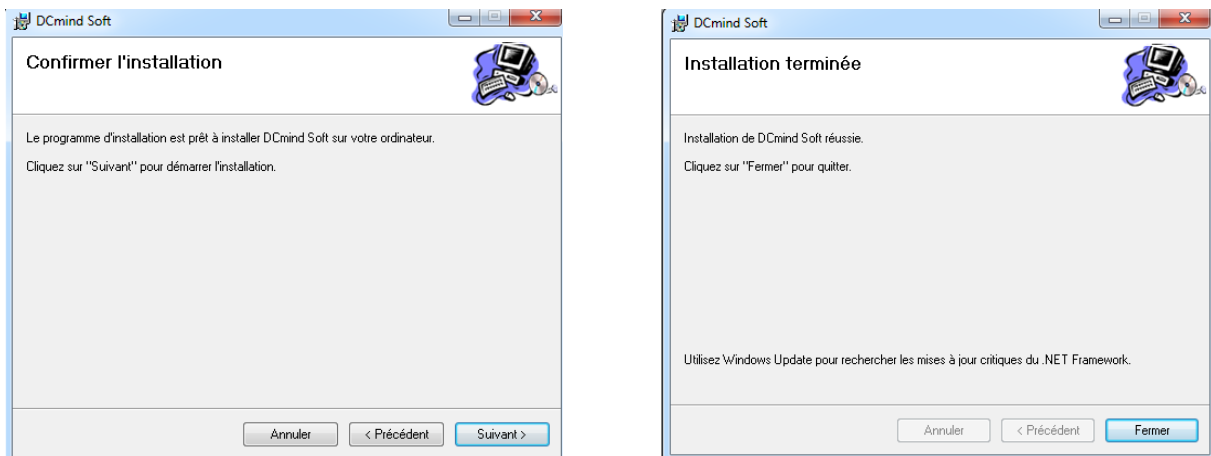
### 10.4. Installation of the Crouzet DCmind-Soft HMI

Run the "Setup\_DCmind\_Soft\_Vxxx.msi" file and follow the instructions:

- N.B.:**
- When installing the "DCmind-Soft" HMI, check that Bluetooth is disabled on the PC.
  - The USB drivers must always be installed upstream.



**Figure 18:** Steps 1 and 2



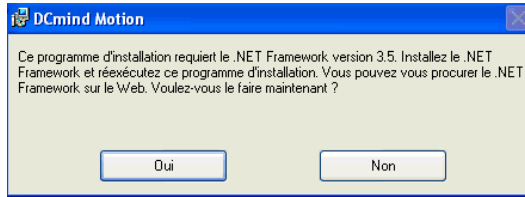
**Figure 19:** Steps 3 and 4

Once installation is complete, the PC software can be launched directly via the "DCmind-Soft" icon on the desktop.

**Note:** To uninstall the "DCmind-Soft" application, follow the standard Windows procedure:

- "Start"
- "Control Panel"
- "Add or Remove Programs"
- "DCmind-Soft"
- "Remove"

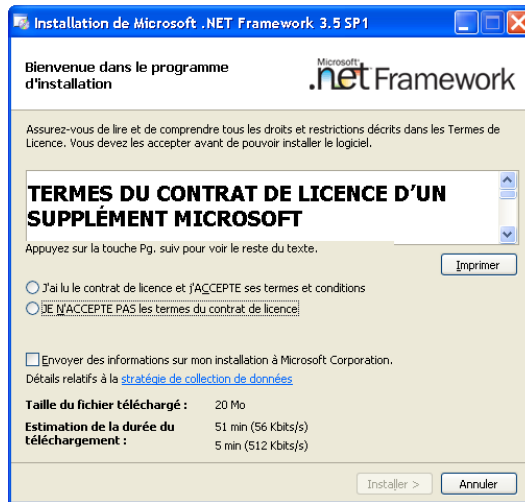
**Note:** For PCs running Windows XP, the version of Framework may not be recent enough to be able to install the "DCmind-Soft" HMI. On launching the setup, the HMI automatically informs the user of this problem by displaying the following window:



**Figure 20**

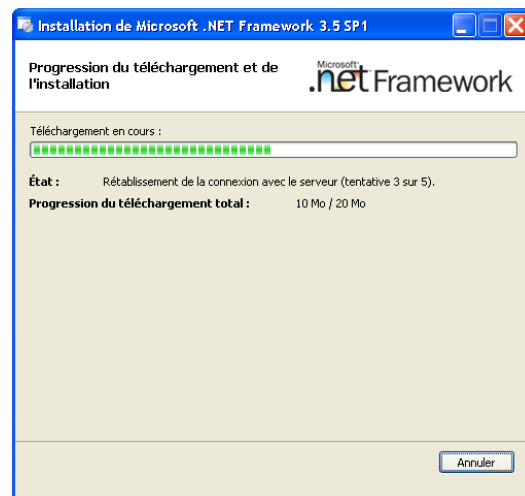
We recommend that you download the latest available version of Framework from the Microsoft website. Should no internet connection be available, a minimum version of Framework is supplied on the USB stick in the programming kit.

To install version 3.5 of Framework supplied on the USB stick, run the "dotnetfx35.exe" file and follow the instructions:



**Figure 21**

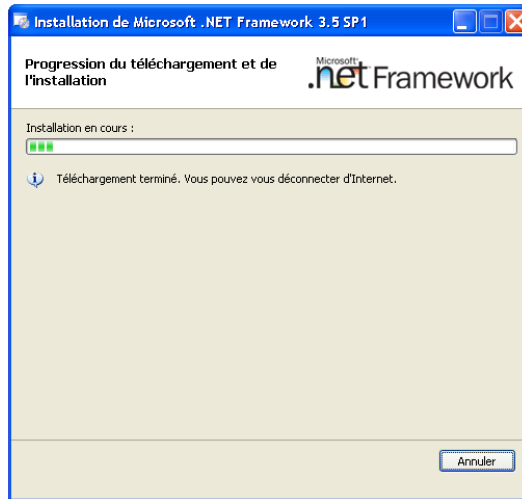
Tick the box "I have read and accept the license terms", then press the "Install >" button.



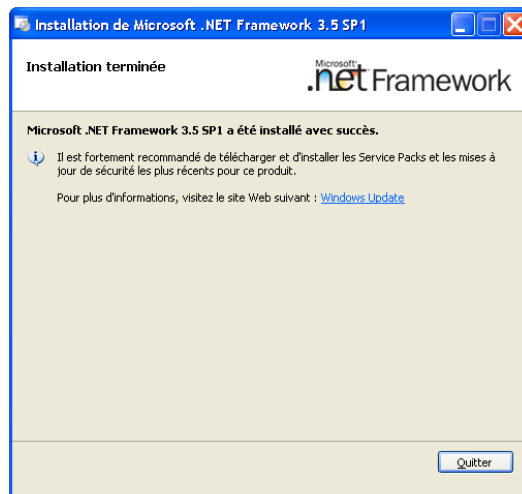
**Figure 22**



During installation, Windows tries to connect to the server to download the Framework multi-language package (this may take several minutes as 5 attempts are made to connect to the server). After 5 attempts, the software is installed directly via the setup supplied on the USB stick:



**Figure 23**



**Figure 24**

Once installation of Framework 3.5 is complete, try again to install the "DCmind-Soft" HMI, referring to the "Installation of the Crouzet DCmind-Soft HMI" section in this document.

### 10.5. Description of the Main Window

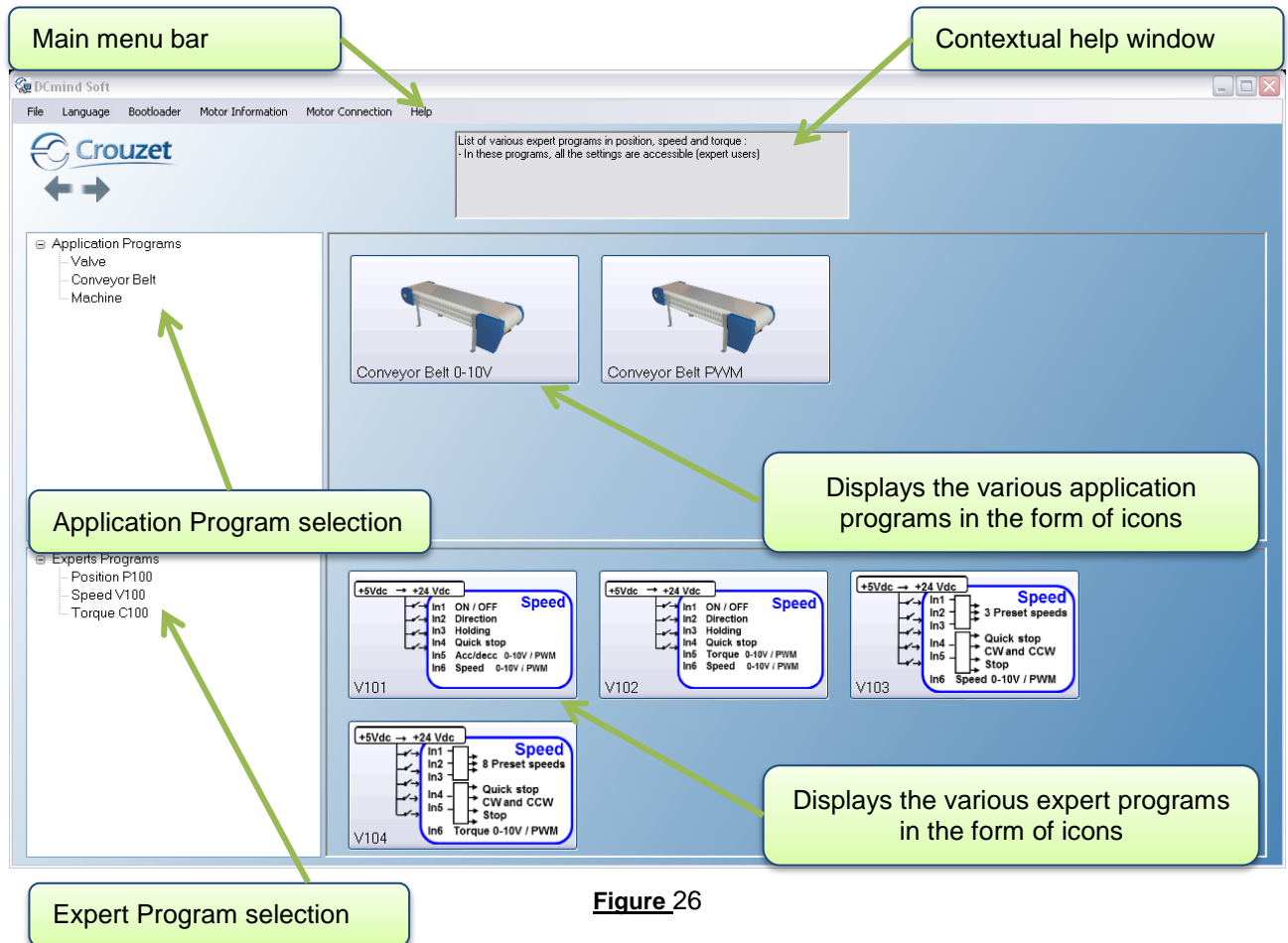
Once all the installations are complete (drivers + HMI), connect the motor to the PC and launch the HMI by double-clicking on the icon below:



DCmind Soft.exe

**Figure 25**

The HMI home page appears:



**Figure 26**

Application programs:

- The application programs are grouped together with similar applications (valve, conveyor belt, machine, etc.).
- They enable quick start-up with completion of just a few key application values.
- Each application program is based on a preconfigured expert program. After testing the motor a few times in the application, the user can refine the motor operation by accessing all the adjustment parameters via the expert program linked to the application program and changing the pre-filled values.

Expert programs:

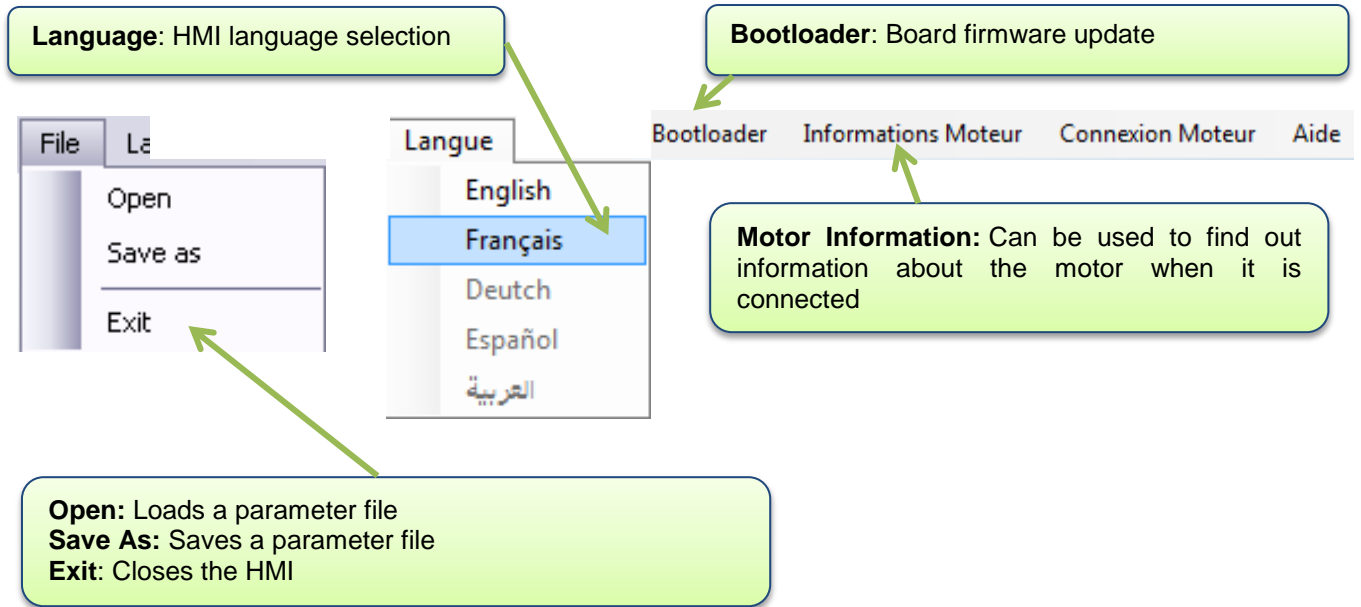
- The expert programs are grouped together with similar programs (P1xx, P2xx, etc position control, V1xx, V2xx speed control, C1xx, C2xx torque control).
- These are generic programs, not specific to any application. They can be used to access all the options and settings.

- They can be used directly, without going via the "application program" step and they offer a wider choice of uses.

The contextual help window gives a description of the selected application when you hover over it with the mouse cursor.

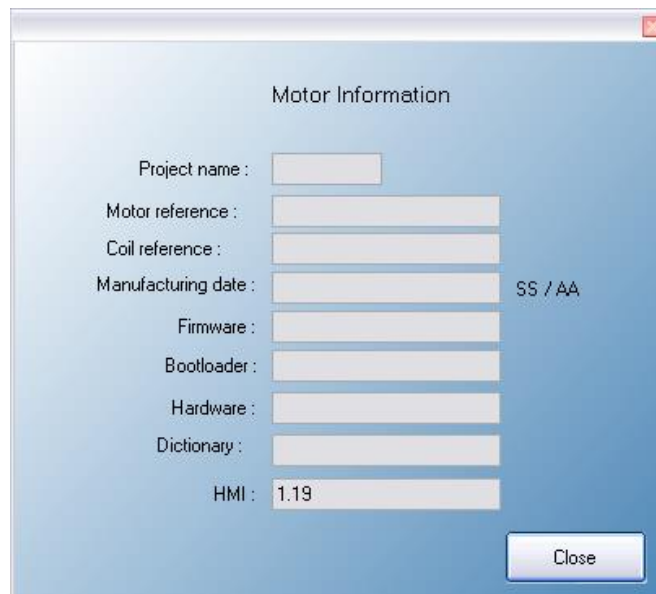
Note: DCmind-Soft is constantly being improved. The latest available update can be downloaded from our website <http://www.crouzet.com/>

Description of the tabs on the main menu bar:



**Figure 27**

"Motor Information" window

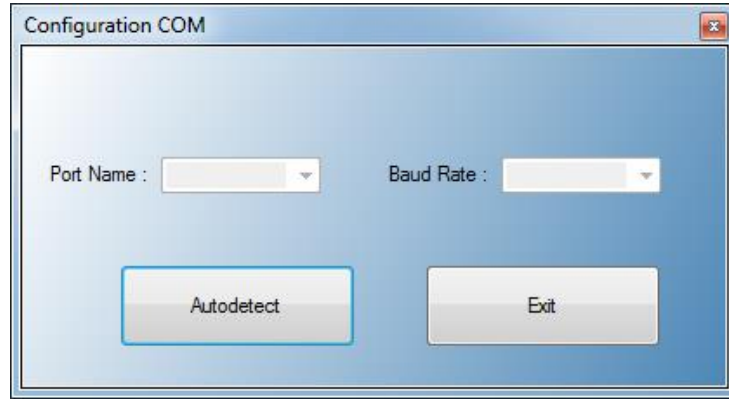


**Figure 28**

The "Help" tab contains the SMi21 DCmind Brushless motors user manual in .pdf format.

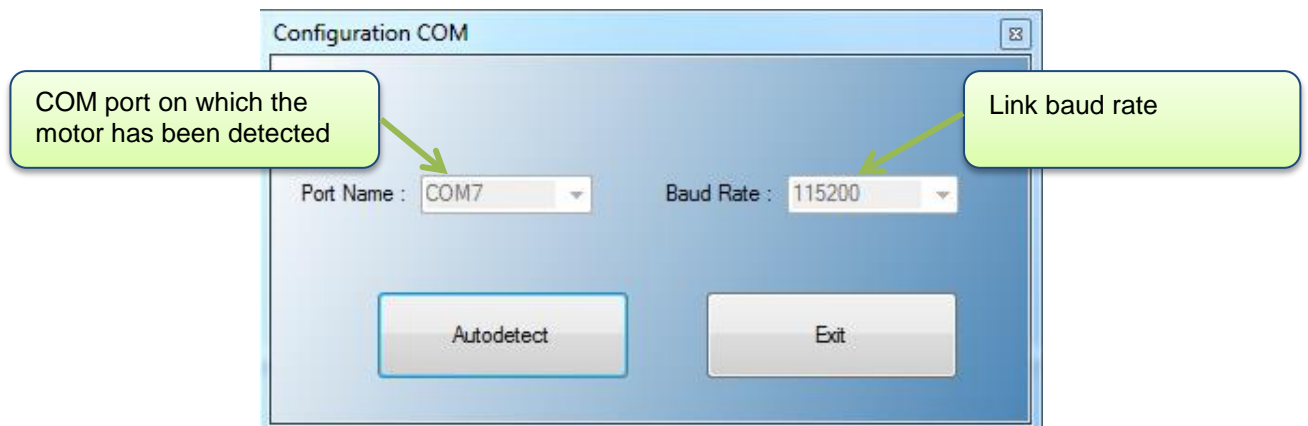
### 10.6. Motor Connection

To connect the motor, link the motor and the PC using the USB B to USB A micro cable (supplied in the programming kit), power up the motor and click on "Motor Connection" in the main menu bar. The following window appears:

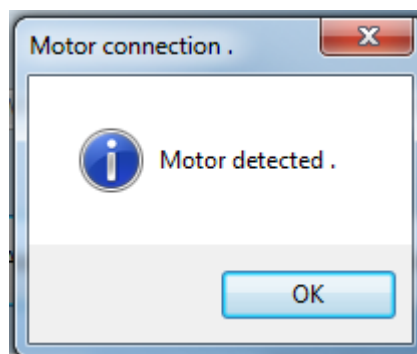


**Figure 29**

Click the "Autodetect" button to start the automatic motor search. If a motor is connected to the PC, it is automatically detected and the following window appears:



**Figure 30**



**Figure 31**

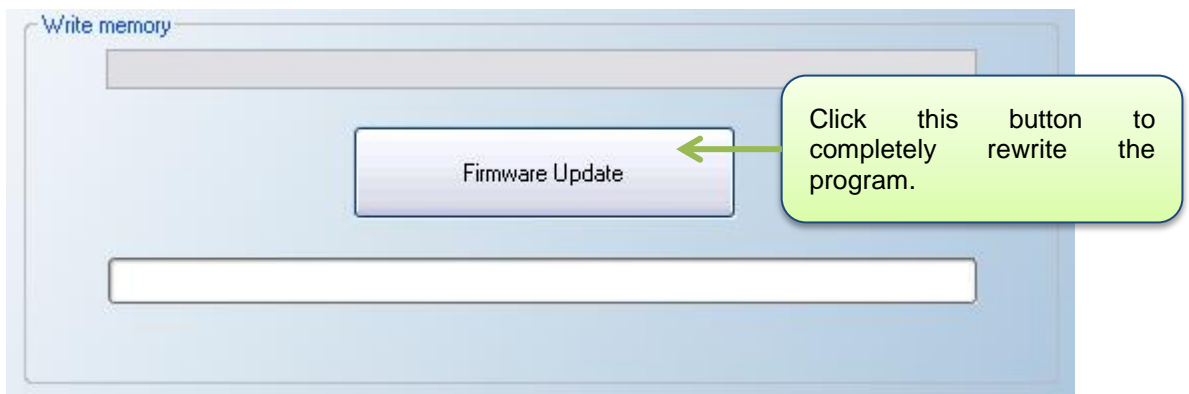
Click "OK", the motor is now connected and ready to be used.

If "Motor not detected" appears in the information window, check that the motor is correctly supplied with power, the micro USB B to USB A cable is plugged in correctly and repeat the procedure.

## 10.7. Updating the Firmware

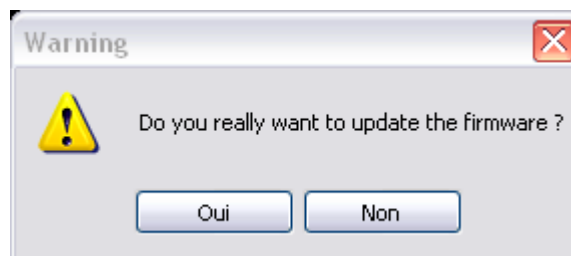
To update the version of the software embedded in the motor, a bootloader is used via USB communication. This operation can only be performed by advanced users, as if done incorrectly this could result in the product not working.

Power up the motor and click "Bootloader" in the main menu bar (entire memory completely rewritten), the following window appears:



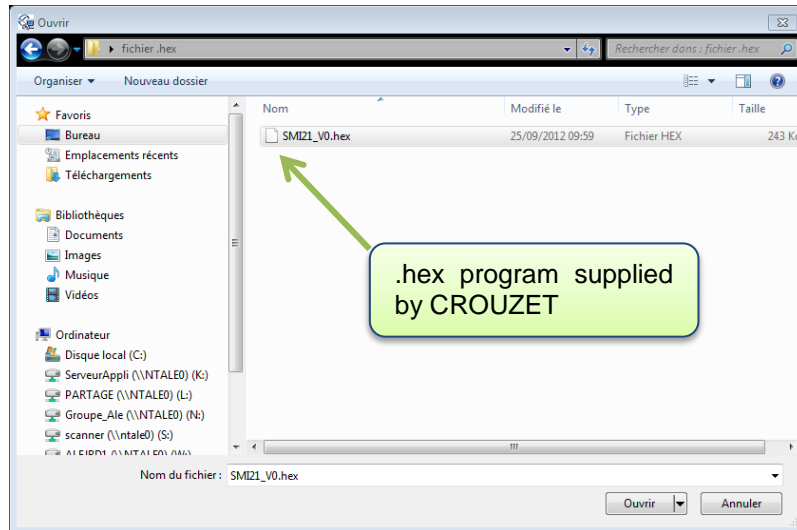
**Figure 32**

A warning message appears asking to confirm the firmware update request and to avoid any incorrect action:



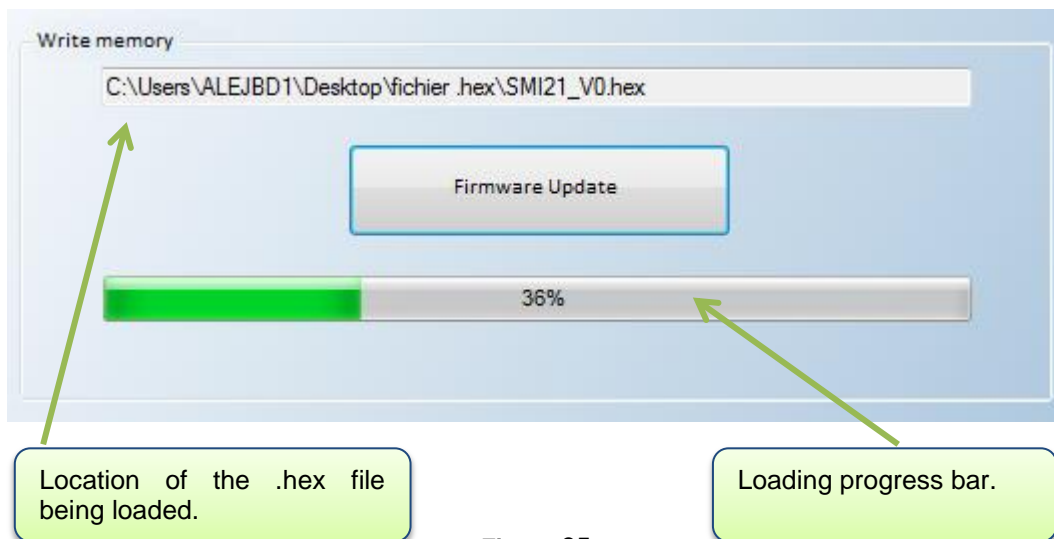
**Figure 33**

To start the update, click "Yes" and select the .hex program supplied by CROUZET:



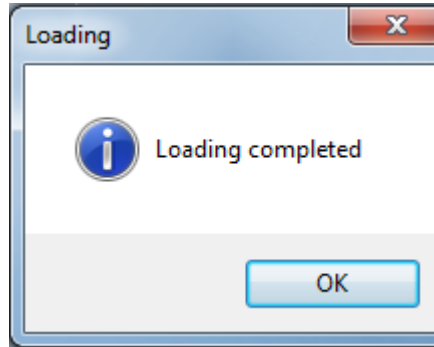
**Figure 34**

Click the "Open" button, updating begins:



**Figure 35**

When the update is complete, the following window appears, meaning that loading has been successful:

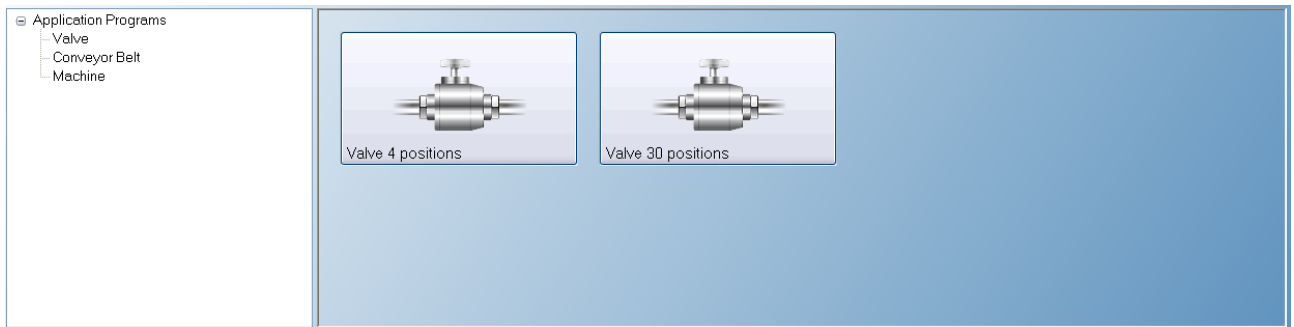


**Figure 36**

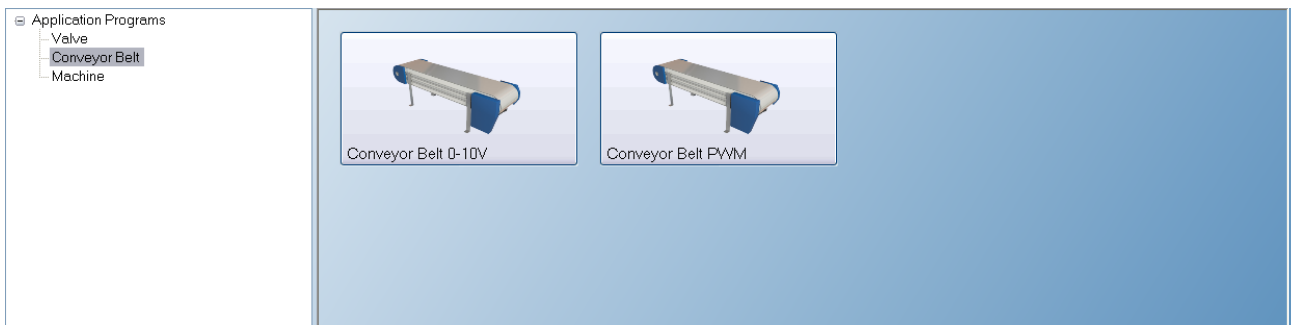
## **11. APPLICATION PROGRAMS**

### **11.1. Description**

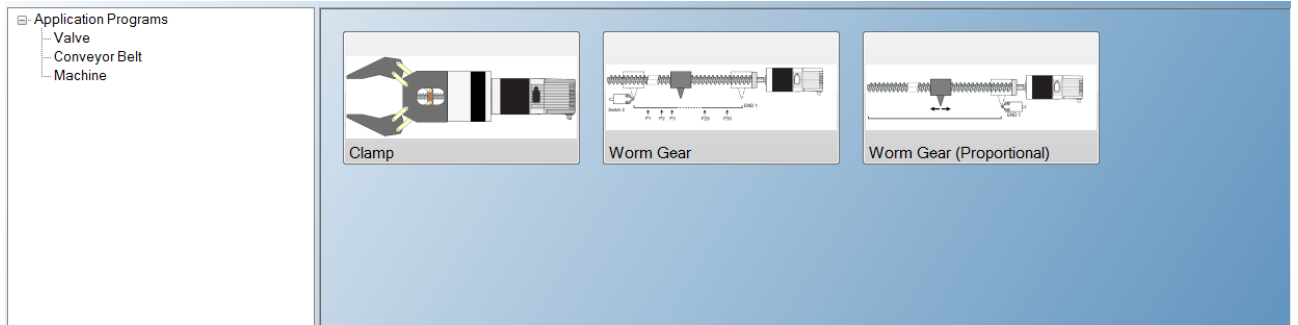
Select an application group from the list of application programs, then one of the icons corresponding to your application.



**Figure 37**



**Figure 38**



**Figure 39**



### 11.2. Description of the Monitoring Part

The monitoring part of the HMI is common to all the expert and application program tabs.



**Figure 40**

This zone uses graphic icons to indicate the type of program I/O used (in this case 4 digital inputs, 2 analog setpoint inputs, 2 PWM outputs and 2 digital outputs).

This zone describes the status of the connection between the HMI and the motor (green for connected and red for not connected). It gives in real time (once a second) the value of the various measurements taken on the motor (voltage, temperature, speed, position and torque).

States of the various program digital I/O (green for active and blue for inactive). For the analog setpoints, the user can display their value (rpm, rpm/sec, mN.m, etc.) on the IN5 and IN6 dial faces. The type of error detected can be viewed on this tab. PWM/Pulse or Frequency type outputs are not included in this tab.

### 11.3. "Valve" Group

#### 11.3.1. "Valve 4 positions" Application Program

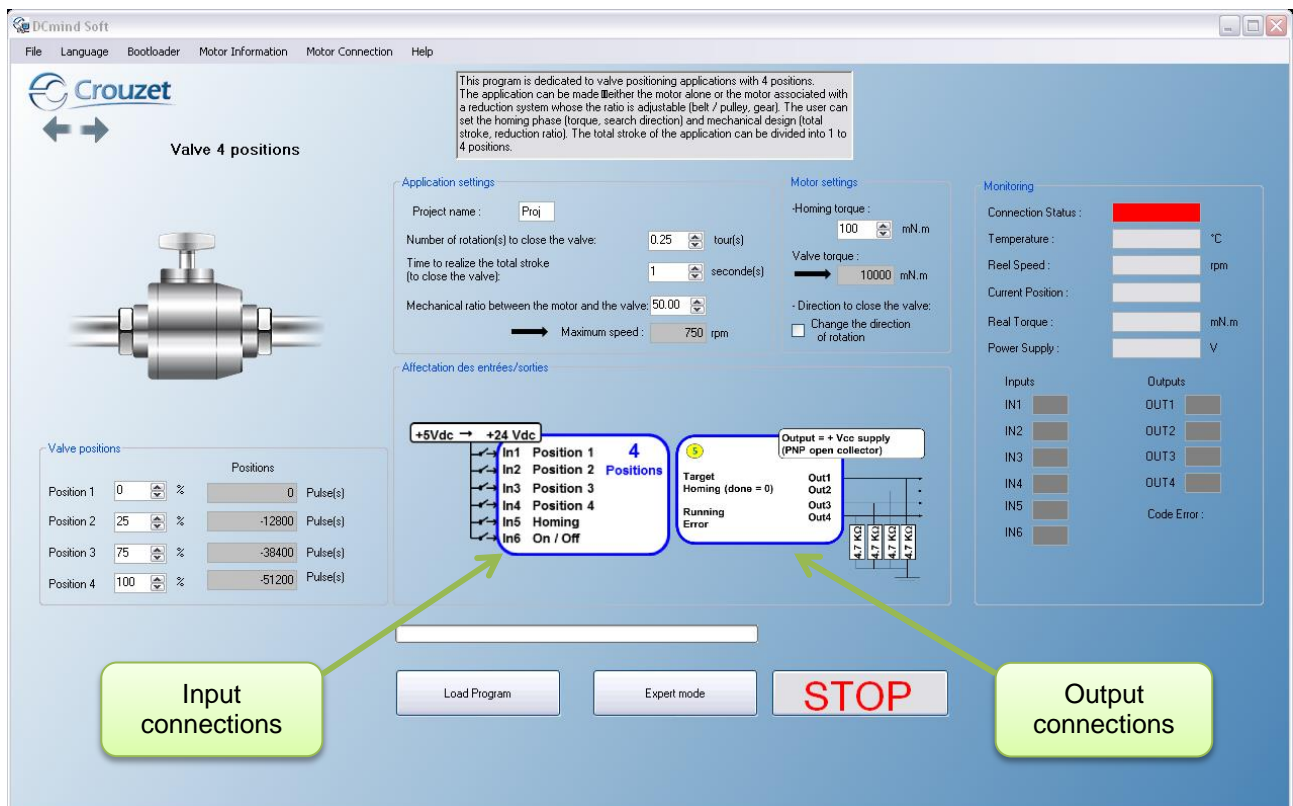


Figure 41

The "Valve 4 positions" application program invokes the P101 expert program.

The user can switch to this expert mode at any time to access all the settings by clicking the "Expert Mode" button.

The values preset in application mode will be loaded directly in expert mode.

It is then impossible to return to this application program.

The user can press the "STOP" button at any time to stop the application quickly.

To restart the motor, the program needs to be reloaded.

Once the settings are complete, press the "Load Program" button to configure the motor.

**Note:** Each time you power ON the power supply or a program is loaded, it is necessary to perform the homing sequence.

##### 11.3.1.1. Inputs/Outputs Configuration

Refer to the "I/O Connection" section.

###### Inputs:

- IN1: If 0 → No position setpoint, if 1 → Setpoint = "Position 1" Parameter
- IN2: If 0 → No position setpoint, if 1 → Setpoint = "Position 2" Parameter
- IN3: If 0 → No position setpoint, if 1 → Setpoint = "Position 3" Parameter
- IN4: If 0 → No position setpoint, if 1 → Setpoint = "Position 4" Parameter
- IN5: If 0 → No action, if 1 → Launch homing phase
- IN6: If 0 → Stop, if 1 → Run

N.B.: if more than 1 input IN1 to IN4 is activated at the same time, the motor switches to stop mode.

Outputs: Don't forget to fit the pull-down resistors on each of the outputs.

- OUT1: If 0 → setpoint position not reached, if 1 → setpoint position reached.
- OUT2: If 0 → homing phase complete, if 1 → homing phase in progress or not performed.
- OUT3: If 0 → motor stopped, if 1 → motor running.
- OUT4: If 0 → no error, if 1 → error detected.

### 11.3.1.2. Application Settings

- The user can give a 4-character name in "Project name" which is stored in the motor and appears in the "Motor Information" window.
- If it has been saved on the PC by the user, this name is used by default. For more details, see the "Saving Parameters" paragraph.
- The "Number of rotation(s) to close the valve" and "Mechanical ratio between the motor and the valve" parameters are used to calculate the application total stroke in number of motor revolutions:

$$Total\ course\ [Rotation\ motor] = Nb\ of\ rotation_{Closing\ valve} \times \eta_{Vaves\ vs\ Motor}$$

- The "Time to realize the total stroke" parameter is used to calculate the motor speed of rotation during the positioning phases:

$$Motor\ speed\ [RPM] = \frac{Total\ course\ [Rotation_{motor}] \times 60}{Times_{total\ course}\ [sec]}$$

The calculated value is given for information in the grayed-out box.

- The motor speed of rotation during the mechanical stop search phase (homing) is determined as follows:

$$Homing\ speed\ [RPM] = \frac{Motor\ speed\ [RPM]}{5}$$

### 11.3.1.3. Motor Configuration

- Used to configure the mechanical stop search phase (homing) by setting the "Homing torque" and the direction of valve closing.
- The nominal and maximum torques **in the motor** are determined from the "Homing torque" value as follows:

$$Nominal\ torque = Homing\ torque$$

$$Torque\ Maxi = 2 \times Homing\ torque$$

- For information, the maximum torque value **seen by the valve** during operation is given in the grayed-out box.

### 11.3.1.4. Valve Positioning

- The user has the option of setting 4 setpoint position parameters as a percentage of valve opening.
- By default, position 1 corresponds to detection of the mechanical stop (valve closed). If the user wishes to add an offset to avoid mechanical shocks during valve closing, he should change the "Position 1" parameter accordingly.
- By default, position 4 corresponds to the application total stroke (valve open).
- For information, all 4 positions are given in number of pulses (4096 pulses per motor revolution) in the grayed-out boxes.

11.3.2. "Valve 30 positions" Application Program with 1 Mechanical Stop

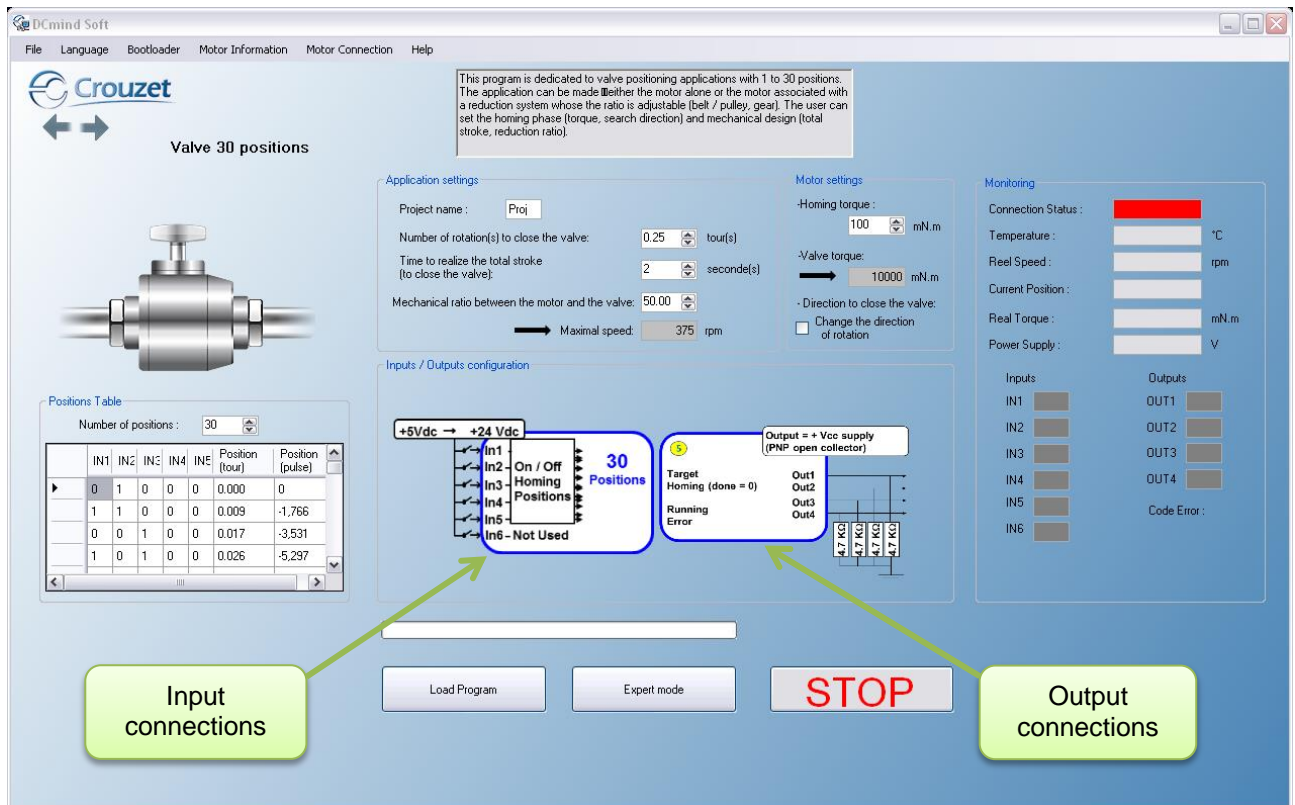


Figure 42

The "Valve 30 positions" application program invokes the P111 expert program. The user can switch to this expert mode at any time to access all the settings by clicking the "Expert Mode" button. The values preset in application mode will be loaded directly in expert mode. It is then impossible to return to this application program. The user can press the "STOP" button at any time to stop the application quickly. To restart the motor, the program needs to be reloaded. Once the settings are complete, press the "Load Program" button to configure the motor.

**Note:** Each time you power ON the power supply or a program is loaded, it is necessary to perform the homing sequence.

11.3.2.1. Inputs/Outputs Configuration

Refer to the "I/O Connection" section.

Inputs:

- IN1 to IN5: 32 possible combinations:
  - IN1 = IN2 = IN3 = IN4 = IN5 = 0 → Stop.
  - IN1 = 1, all 4 others = 0 → Launch homing phase.
  - The other 30 combinations correspond to the 30 position setpoints.
- IN6: Not used.

Outputs: Don't forget to fit the pull-down resistors on each of the outputs.

- OUT1: If 0 → setpoint position not reached, if 1 → setpoint position reached.
- OUT2: If 0 → homing phase complete, if 1 → homing phase in progress or not performed.
- OUT3: If 0 → motor stopped, if 1 → motor running.
- OUT4: If 0 → no error, if 1 → error detected.

### 11.3.2.2. Application Settings

- The user can give a 4-character name in "Project name" which is stored in the motor and appears in the "Motor Information" window.
- If it has been saved on the PC by the user, this name is used by default. For more details, see the "Saving Parameters" paragraph.
- The "Number of rotation(s) to close the valve" and "Mechanical ratio between the motor and the valve" parameters are used to calculate the application total stroke in number of motor revolutions:

$$Totale\ course\ [Rotation_{motor}] = Nb\ rotation\ closing\ valve \times \eta_{Valve\ vs\ Motor}$$

- The "Time to realize the total stroke" parameter is used to calculate the motor speed of rotation during the positioning phases:

$$Motor\ speed\ [RPM] = \frac{Totale\ course[rotation\ motor] \times 60}{Times_{Totale\ course}\ [sec]}$$

The calculated value is given for information in the grayed-out box.

- The motor speed of rotation during the mechanical stop search phase (homing) is determined as follows:

$$Homing\ speed[RPM] = \frac{Motor\ speed\ [RPM]}{5}$$

### 11.3.2.3. Motor Configuration

- Used to configure the mechanical stop search phase (homing) by setting the "Homing torque" and the direction of valve closing.
- The nominal and maximum torques **in the motor** should be determined from the "Homing torque" value as follows:

$$Nominal\ torque = Homing\ torque$$

$$Maxi\ torque = 2 \times Homing\ torque$$

- For information, the maximum torque value **seen by the valve** during operation is given in the grayed-out box.

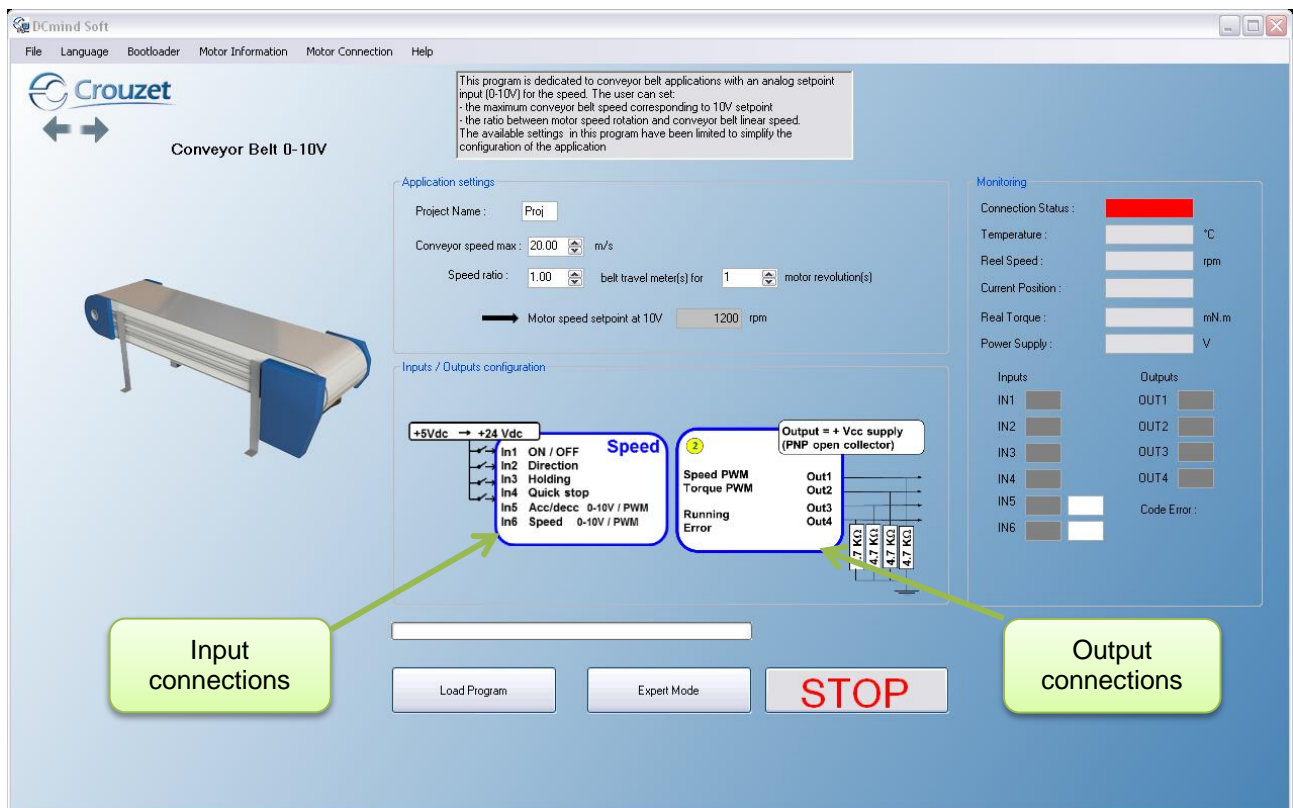
### 11.3.2.4. Position Table

- The user is not able to change the position setpoints, they will automatically be defined with between 2 and 30 equal positions, according to the defined total stroke and the "Number of positions" parameter. To change them, you need to change to "Expert Mode".
- By default, position 1 corresponds to detection of the mechanical stop (valve closed).
- By default, the last position corresponds to the application total stroke (valve open).

- For information, the position setpoints are given in number of valve rotations and number of pulses (4096 pulses per motor revolution).

## 11.4. "Conveyor Belt" Group

### 11.4.1. "Conveyor Belt 0-10V" Application Program



**Figure 43**

The "Conveyor Belt 0-10V" application program invokes the V101 expert program.

The user can switch to this expert mode at any time to access all the settings by clicking the "Expert Mode" button.

The values preset in application mode will be loaded directly in expert mode.

It is then impossible to return to this application program.

The user can press the "STOP" button at any time to stop the application quickly.

To restart the motor, the program needs to be reloaded.

Once the settings are complete, press the "Load Program" button to configure the motor.

#### 11.4.1.1. Inputs/Outputs Configuration

Refer to the "I/O Connection" section.

##### Inputs:

- IN1: If 0 → Stop, if 1 → Run
- IN2: If 0 → motor running in reverse (CCW), if 1 → motor running forward (CW)
- IN3: If IN3 = 1 and IN1 = 1 and IN6 = 0, application of a 150 mNm holding torque.
- IN4: If 0 → no action, if 1 → Quick start by short-circuiting the coils. This action takes priority over the other commands.
- IN5: 0-10 V control. Sets the motor acceleration and deceleration. 40,000 rpm/sec for 0 V (maximum acceleration) and 100 rpm/sec for 10 V.

- IN6: 0-10 V control. Sets the speed setpoint. 0 V for 0 rpm and 10 V for the maximum motor speed defined by the user.

Outputs: Don't forget to fit the pull-down resistors on each of the outputs.

- OUT1: Provides information on the motor speed value in PWM.  
Cyclical ratio = 0% → speed = 0 rpm  
Cyclical ratio = 100% → speed = maximum speed.
- OUT2: Provides information on the real torque value in PWM.  
Cyclical ratio = 0% → torque = 0 mNm  
Cyclical ratio = 100% → torque = 1 Nm.
- OUT3: If 0 → motor running, if 1 → motor stopped.
- OUT4: If 0 → error detected, if 1 → no error.

#### 11.4.1.2. Application Settings

- The user can give a 4-character name in "Project name" which is stored in the motor and appears in the "Motor Information" window.
- If it has been saved on the PC by the user, this name is used by default. For more details, see the "Saving Parameters" paragraph.
- The maximum motor speed corresponding to a voltage of 10 V is calculated as follows:

$$\text{Setpoint motor speed}_{10V}[\text{RPM}] = \frac{\text{Max speed Tapis } [m \cdot s^{-1}] \times 60}{\text{Speed step } [m \cdot tr^{-1}]}$$

The calculated value is given for information in the grayed-out box.



11.4.2. "Conveyor Belt PWM" Application Program



Figure 44

The "Conveyor Belt PWM" application program invokes the V101 expert program. The user can switch to this expert mode at any time to access all the settings by clicking the "Expert Mode" button. The values preset in application mode will be loaded directly in expert mode. It is then impossible to return to this application program. The user can press the "STOP" button at any time to stop the application quickly. To restart the motor, the program needs to be reloaded.

Once the settings are complete, press the "Load Program" button to configure the motor.

11.4.2.1. Inputs/Outputs Configuration

Refer to the "I/O Connection" section.

Inputs:

- IN1: If 0 → Stop, if 1 → Run
- IN2: If 0 → motor running in reverse (CCW), if 1 → motor running forward (CW)
- IN3: If IN3 = 1 and IN1 = 1 and IN6 = 0, application of a 150 mNm holding torque.
- IN4: If 0 → no action, if 1 → Quick start by short-circuiting the coils. This action takes priority over the other commands.
- IN5: PWM control. Sets the motor acceleration and deceleration. 40,000 rpm/sec for 0% PWM (maximum acceleration) and 100 rpm/sec for 100% PWM.
- IN6: PWM control. Sets the speed setpoint. 0% PWM for 0 rpm and 100% PWM for the maximum motor speed defined by the user.

Outputs: Don't forget to fit the pull-down resistors on each of the outputs.

- OUT1: Provides information on the motor speed value in PWM.  
Cyclical ratio = 0% → speed = 0 rpm  
Cyclical ratio = 100% → speed = maximum speed.
- OUT2: Provides information on the real torque value in PWM.  
Cyclical ratio = 0% → torque = 0 mNm  
Cyclical ratio = 100% → torque = 1 Nm.
- OUT3: If 0 → motor running, if 1 → motor stopped.
- OUT4: If 0 → error detected, if 1 → no error.

#### 11.4.2.2. Application Settings

- The user can give a 4-character name in "Project name" which is stored in the motor and appears in the "Motor Information" window.
- If it has been saved on the PC by the user, this name is used by default. For more details, see the "Saving Parameters" paragraph.
- The maximum motor speed corresponding to a PWM signal with 100% cyclical ratio is calculated as follows:

$$\text{Setpoint motor speed}_{100\% PWM} [RPM] = \frac{\text{Max speed} [m. s^{-1}] \times 60}{\text{Speed step} [m. tr^{-1}]}$$

The calculated value is given for information in the grayed-out box.

11.4.3. « Conveyor with stop on detection » Application program

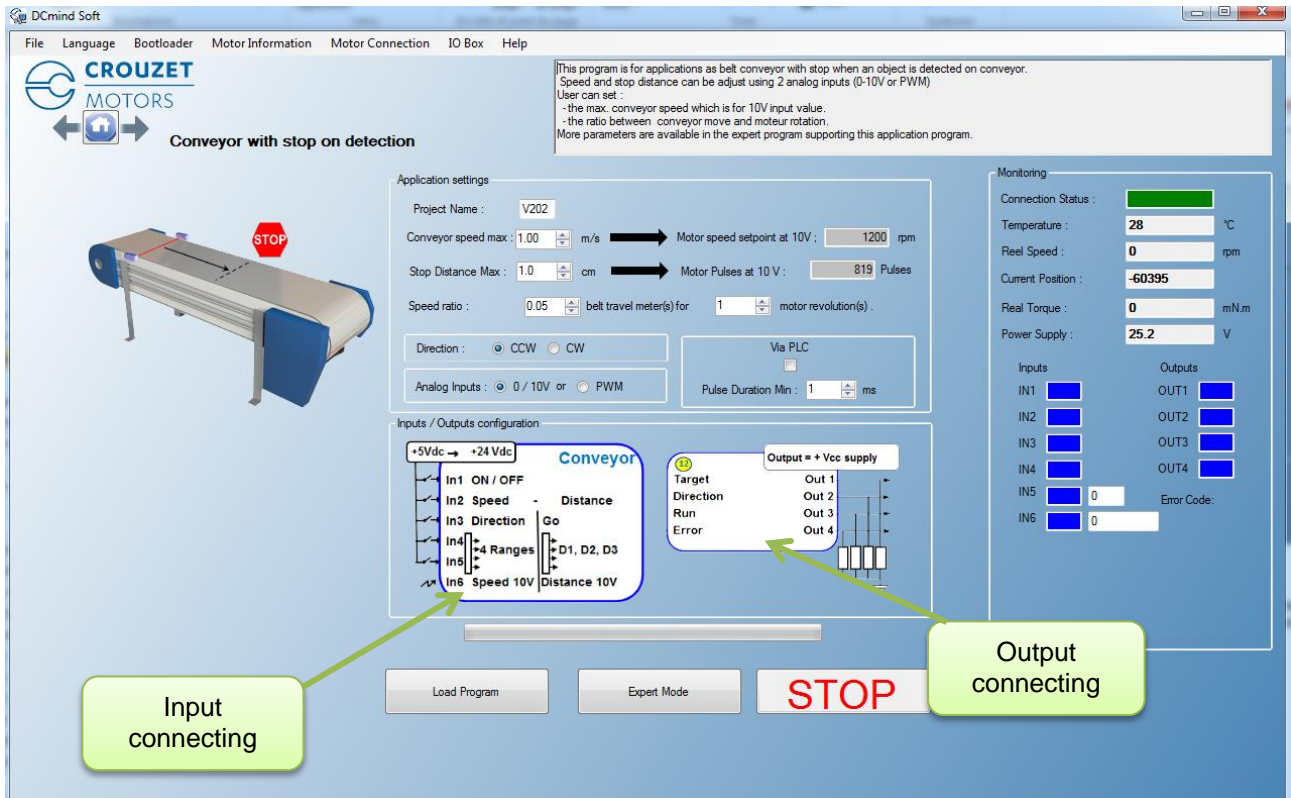


Figure 45

The « Conveyor belt with stop on detection » application program invokes the V202 expert program. The user can switch to this expert mode at any time to access all the settings by clicking the "Expert Mode" button.

The values preset in application mode will be loaded directly in expert mode. It is then impossible to return to this application program.

The user can press the "STOP" button at any time to stop the application quickly. To restart the motor, the program needs to be reloaded.

Once settings are complete, press the "Load Program" button to configure the motor.

11.4.3.1. Inputs/Outputs Configuration

Refer to the "I/O Connection" section.

Inputs: (0 = no voltage applied; 1 = voltage applied on the input)

- IN1 : « ON/OFF »                                 0 → Stop,                                 1 → Run
- IN2 : « Usual belt direction »                0 → Direction from program setting  
  1 → Direction inverted

Note: this input is useful when a same program setting is needed for conveyors having to run in opposite directions.

- IN3 : « Reverse direction »                    0 → No reverse                                 1 → Reverses and inhibits IN4
- IN4 : « Sensor »                                 0 → Nothing detected                             1 → Stop required (if IN3 = 0)
- IN5 : « Speed »                                 Analog input (0/10V or PWM)                 → Speed setting
- IN6 : « Position »                               Analog input (0/10V or PWM)                 → Stop distance setting

Outputs: Don't forget to fit the pull-down resistors on each of the outputs.

- OUT1 : Target  
0 : Stop position not reached                      1 : Stop position reached
- OUT2 : Direction.  
0 : Motor CCW (counter clock wise)              1 : Motor CW (clock wise)
- OUT3 : Run  
0 : No run    1 : Motor running
- OUT4 : Error :  
0: No error detected                                      1: Error detected.

### 11.4.3.2. Application Settings

- The user can give a 4-character name in "Project name" which is stored in the motor and appears in the "Motor Information" window.
- If it has been saved on the PC by the user, this name is used by default. For more details, see the "Saving Parameters" paragraph.
- Parameters « Max. belt speed » and « Mechanical ratio » allow to define the maximum motor speed at 10V input.
- Maximum motor speed is calculated as following :

$$Motor\ speed_{10V}[RPM] = \frac{Max\ belt\ speed\ [m.s^{-1}] \times 60}{Mechanical\ ratio\ [m.tr^{-1}]}$$

This value is indicated in the grey box for information.

- Belt conveyor stop distance is calculated as following :  
Parameters « Max. stop distance » and « Mechanical ratio » are used to calculate the maximum rotation of the motor in number of pulses (4096 pulses represent one motor turn).

$$Motor\ pulses_{10V}[Pulses] = \frac{Max.\ stop\ distance\ [cm] \times 4096}{100 * Mechanical\ ratio\ [m.tr^{-1}]}$$

This value is indicated in the grey box for information.

- « Motor direction » area allows to define the motor direction by defect (when IN2 = 0). Conveyor belt manufacturers ask for good use, that conveyor's motor pulls the belt which brings objects (not push).
- « Command » area allows to define which signal type will be used for IN5 and IN6.
- Option "Via PLC" allows to precise if the "sensor" input is driven by PLC (if selected) or directly by the object's sensor (if not selected).  
When "Via PLC" is not selected, motor memorizes the "sensor" detections and goes to stop position even if the detected object exceeds the detector. To restart the conveyor in speed, an OFF/ON action on IN1 has to be done.
- Parameter « minimum pulse duration » allows to filter IN4 sensor input signal. The signal has to exceed this time before to be taken in count.

## 11.5. "Machine" Group

### 11.5.1. "Worm Gear" Application Program

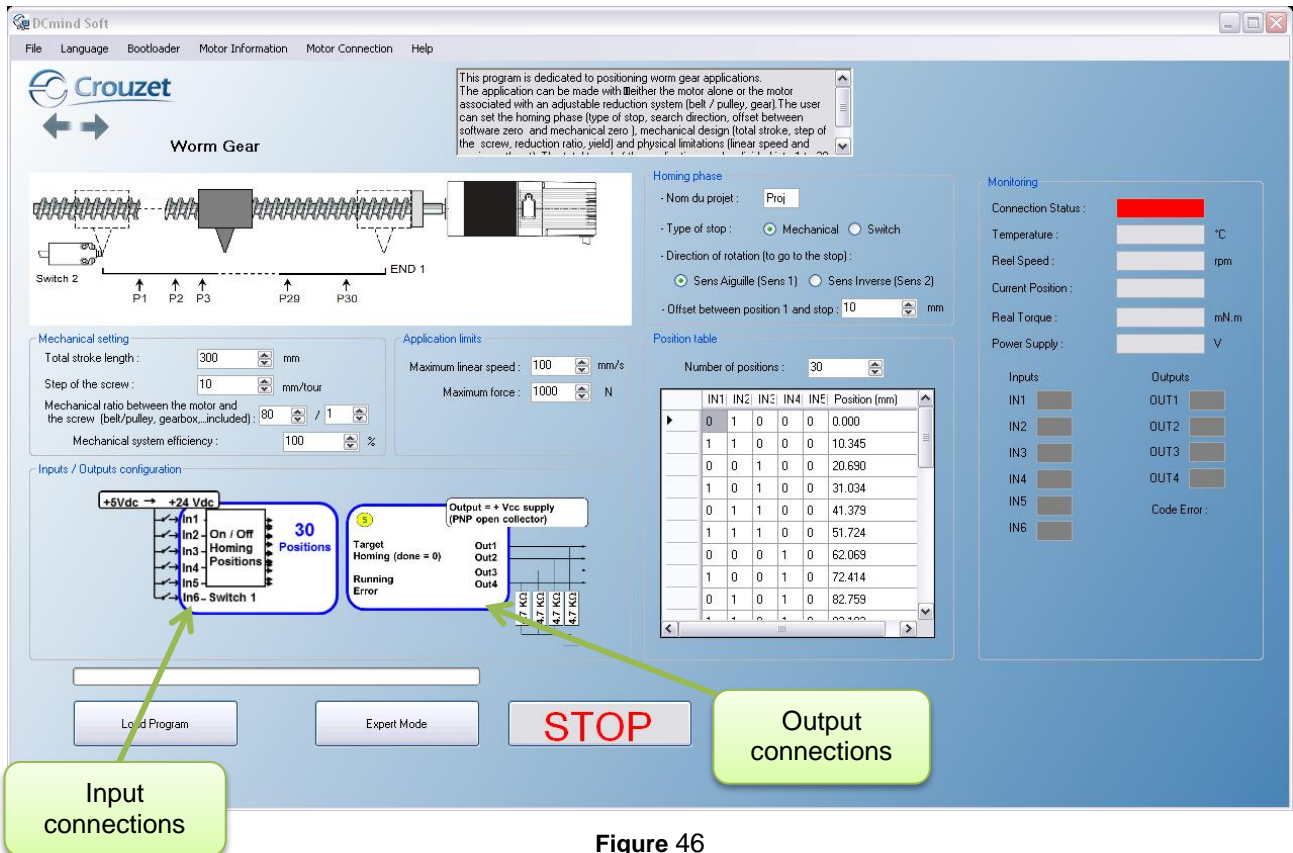


Figure 46

The "Worm Gear" application program uses a preset P111 expert program.

The user can switch to this expert mode at any time to access all the settings by clicking the "Expert Mode" button.

The values preset in application mode will be loaded directly in expert mode.

It is then impossible to return to this application program.

The user can press the "STOP" button at any time to stop the application quickly.

To restart the motor, the program needs to be reloaded.

Once the settings are complete, press the "Load Program" button to configure the motor.

**Note:** Each time you power ON the power supply or a program is loaded, it is necessary to perform the homing sequence.

#### 11.5.1.1. Inputs/Outputs Configuration

Refer to the "I/O Connection" section.

**Inputs:**

- IN1 to IN5: 32 possible combinations:
  - IN1 = IN2 = IN3 = IN4 = IN5 = 0 → Stop
  - IN1 = 1, all 4 others = 0 → Launch homing phase
  - The other 30 combinations correspond to the 30 position setpoints
- IN6: Switch limit input if « switch » is selected as "type of stop"

Outputs: Don't forget to fit the pull-down resistors on each of the outputs.

- OUT1: If 0 → setpoint position not reached, if 1 → setpoint position reached.
- OUT2: If 0 → homing phase complete, if 1 → homing phase in progress or not performed.
- OUT3: If 0 → motor stopped, if 1 → motor running.
- OUT4: If 0 → no error, if 1 → error detected.

### 11.5.1.2. Initialization Phase

- The user can give a 4-character name in "Project name" which is stored in the motor and appears in the "Motor Information" window.
- If it has been saved on the PC by the user, this name is used by default. For more details, see the "Saving Parameters" paragraph.
- Select the type of stop, either "Mechanical" if the stop is achieved by detection of an obstacle on the application, or "Switch" if a limit switch is used in the application.
- Define the motor direction of rotation used to reach the stop selected above (forward (CW) rotation by default).
- To protect the application and prevent the mechanical stop being reached each time it returns to position zero, a position offset (in mm) can be set between the mechanical stop and position 1 corresponding to the application reference.

### 11.5.1.3. Application Settings

- To determine the maximum operating speed during the positioning phases, the user should enter the maximum linear speed in mm/s and the "Step of the screw" and "Mechanical ratio between the motor and the screw" adjustment parameters are used to obtain a motor speed of rotation according to the formula below:

$$Motor\ speed\ [RPM] = \frac{Linear\ speed\ [mm/s] \times step_{Reduction} \times 60}{Step_{screw}\ [mm/rotation]}$$

- The motor speed of rotation during the mechanical stop search phase (homing) is determined as follows:

$$Homing\ speed\ [RPM] = \frac{Motor\ speed\ [RPM]}{5}$$

### 11.5.1.4. Motor Configuration

- To determine the nominal torque during operation, the user should enter the maximum thrust for his application in Newtons and the "Step of the screw" and "Mechanical ratio between the motor and the screw" adjustment parameters are used to obtain a nominal motor torque using the following formula:

$$Motor\ torque\ [mN.m] = \frac{1}{2\pi} \times \frac{Pushing\ [N] \times Step_{screw}\ [mm/tour]}{Step_{Reduction}}$$

- The homing and maximum torques for detecting the mechanical stop **in the motor** are determined from the "Motor Torque" value defined above as follows:

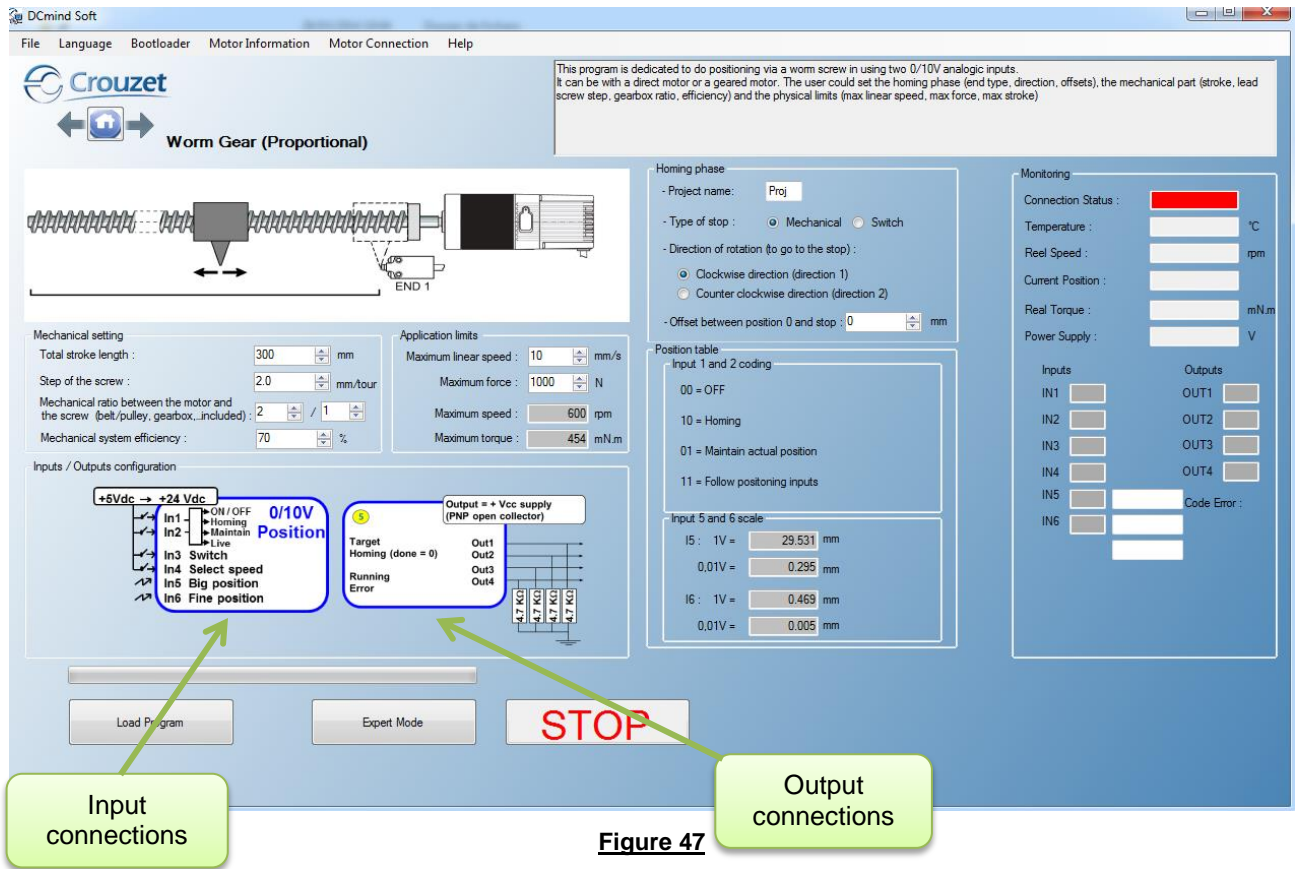
$$Homing\ torque = Motor\ torque$$

*Maxi torque = 2 × Motor torque*

#### 11.5.1.5. Position Table

- The user is not able to enter the 2 to 30 position setpoints himself, they are automatically defined with between 2 and 30 equidistant positions, according to the defined total stroke "Total stroke length" and the "Number of positions" parameter.
- Position 1 corresponds to detection of the mechanical stop (as close as possible to the offset).
- The last position corresponds to the application total stroke.
- In the table, the position setpoints are given in mm.

11.5.2. "Worm Gear (Proportional)" Application Program



The "Worm Gear (Proportional)" application program uses the P201 expert program. The user can switch to this expert mode at any time to access all the settings by clicking the "Expert Mode" button. The values preset in application mode will be loaded directly in expert mode. It is then impossible to return to this application program. The user can press the "STOP" button at any time to stop the application quickly. To restart the motor, the program needs to be reloaded. Once the settings are complete, press the "Load Program" button to configure the motor.

**Note:** Each time you power ON the power supply or a program is loaded, it is necessary to perform the homing sequence

11.5.2.1. Inputs/Outputs Configuration

Refer to the "I/O Connection" section.

Inputs:

- IN1 and IN2 : 4 possible combinations :
  - [IN1-IN2] = [00] → Stop and error reset
  - [IN1-IN2] = [10] → Homing phase
  - [IN1-IN2] = [01] → Maintain actual position
  - [IN1-IN2] = [11] → Go to required position
- IN3 : Switch limit input if « switch » is selected as "type of stop"
- IN4 : High speed (if 0) or low speed (if 1) selection
- IN5 : Proportional position setting – Coarse tuning
- IN6 : Proportional position setting – Thin tuning



Outputs: Don't forget to fit the pull-down resistors on each of the outputs.

- OUT1: Provides information on the motor speed value in PWM.  
     Cyclical ratio = 0%           → speed = 0 rpm  
     Cyclical ratio = 100%       → speed = 4000 rpm.
- OUT2: Provides information on the real torque value in PWM.  
     Cyclical ratio = 0%           → torque = 0 mNm  
     Cyclical ratio = 100%       → torque = maximum torque.
- OUT3: If 0 → motor running,       if 1 → motor stopped.
- OUT4: If 0 → error detected,       if 1 → no error.

### 11.5.2.2. Initialization Phase

- The user can give a 4-character name in "Project name" which is stored in the motor and appears in the "Motor Information" window.
- If it has been saved on the PC by the user, this name is used by default. For more details, see the "Saving Parameters" paragraph.
- Select the type of stop, either "Mechanical" if the stop is achieved by detection of an obstacle on the application, or "Switch" if a limit switch is used in the application.
- Define the motor direction of rotation used to reach the stop selected above (forward (CW) rotation by default).
- To protect the application and prevent the mechanical stop being reached each time it returns to position zero, a position offset (in mm) can be set between the mechanical stop and position 1 corresponding to the application reference.

### 11.5.2.3. Application Settings

- To determine the maximum operating speed during the positioning phases, the user should enter the maximum linear speed in mm/s and the "Step of the screw" and "Mechanical ratio between the motor and the screw" adjustment parameters are used to obtain a motor speed of rotation according to the formula below:

$$\text{Maximum speed [RPM]} = \frac{\text{Maximum linear speed [mm/s]} \times \text{step}_{\text{Reduction}} \times 60}{\text{Step}_{\text{screw}} \text{ [mm/rotation]}}$$

- By activating the digital input 4 (IN4 = 1), the user selects the low speed profile :

$$\text{Low speed [RPM]} = \frac{\text{Maximum speed [RPM]}}{5}$$

- The motor speed of rotation during the mechanical stop search phase (homing) is determined as follows:

$$\text{Homing speed [RPM]} = \frac{\text{Maximum speed [RPM]}}{5}$$

**NB:** Motor speed is restricted to max. 4000rpm in this program. If this value is exceeded, the writing becomes red colored and the loading of the parameters becomes impossible. It is strongly advised to check motor specifications before to configuring the application.

#### 11.5.2.4. Motor Configuration

- To determine the maximum torque during operation, the user should enter the maximum thrust for his application in Newtons and the "Step of the screw" and "Mechanical ratio between the motor and the screw" and "Mechanical system efficiency" adjustment parameters are used to obtain a maximum motor torque using the following formula:

$$\text{Maximum torque [mN.m]} = \frac{1}{2\pi} \times \frac{\text{Pushing [N]} \times \text{Step}_{\text{screw}}[\text{mm/tour}]}{\text{Step}_{\text{Reduction}}} \times 2$$

$$\text{Nominal torque} = \frac{\text{Maximum torque}}{2}$$

- To detect the mechanical end stop, the homing torque is automatically set to be equal to nominal torque.

**NB :** The max. torque has to don't be higher than 1000 mNm. If this value is exceeded, the writing becomes red colored and the loading of the parameters becomes impossible.

The real maximum torque value is limited per motor characteristics. It is strongly advised to check motor specifications before to configuring the application.

#### 11.5.2.5. Position setpoint

- The user indicates the total stroke in mm of the application : parameter « Total stroke length ». The full stroke is achieved when both setpoints (IN5 and IN6) are at 10V. To travel this distance, the settings are distributed as follows:
  - Coarse setting : Input IN5 allows to travel 63/64th of the « total stroke length »
  - Thin setting : Input IN6 allows to travel 1/64th of the « total stroke length »
- The resolution of each of the two inputs IN5 and IN6 is given as an indication in the gray boxes in the « Position table – Input 5 and input 6 scale » zone :
  - Distance equivalent to an applied voltage of 1V
  - Distance equivalent to an applied voltage of 0,01V (resolution of the system)

**Example :** For a «Total stroke length » = 300 mm :

→ Input IN5 allows to travel:  $Stroke_{E5} = \frac{63}{64} \times 300\text{mm} = 295,3125\text{mm}$  (for 10V applied)

Meaning 29,53125 mm for 1V

Meaning 0,2953125 mm for 0,01V

→ Input IN6 allows to travel:  $Stroke_{E6} = \frac{1}{64} \times 300\text{mm} = 4,6875\text{mm}$  (for 10V applied)

Meaning 0,46875 mm for 1V

Meaning 0,0046875 mm for 0,01V

11.5.3. "Clamp" Application Program

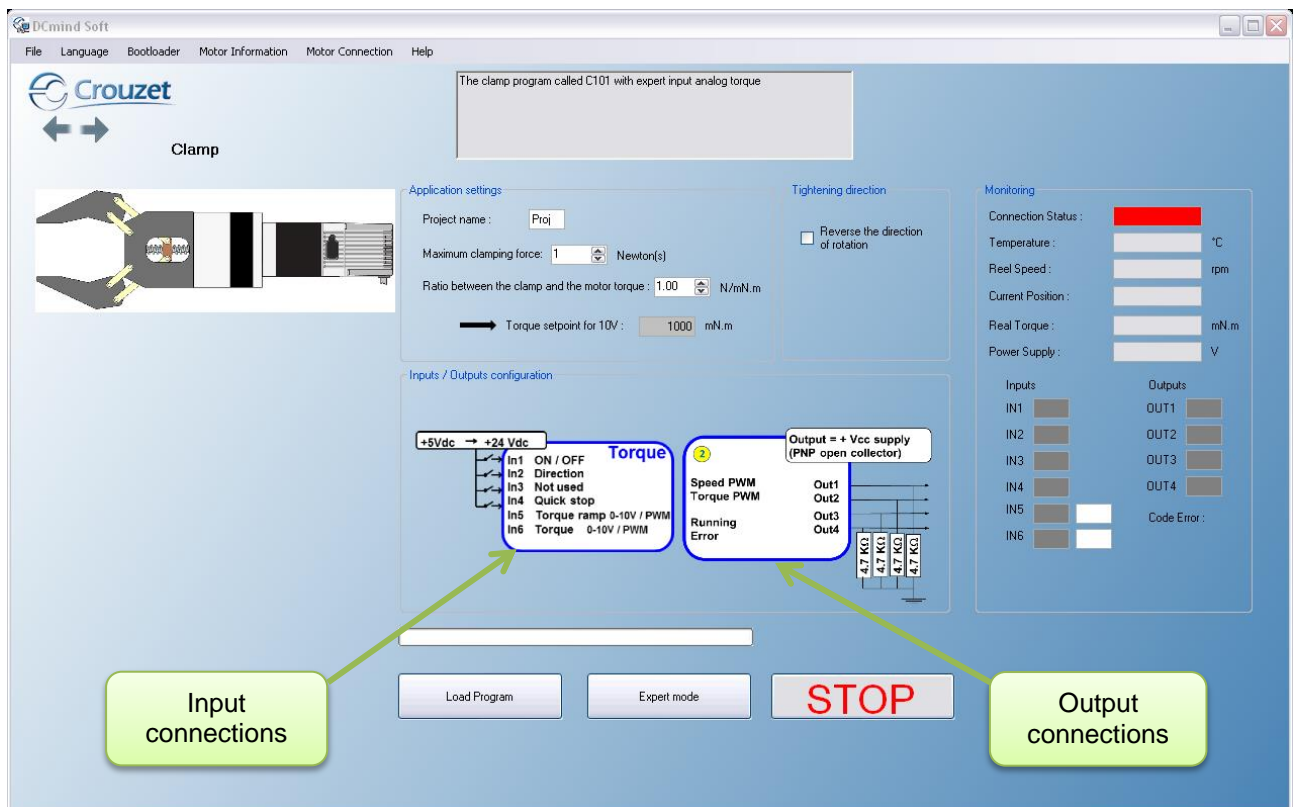


Figure 48

The "Clamp" application program invokes the C101 expert program. The user can switch to this expert mode at any time to access all the settings by clicking the "Expert Mode" button. The values preset in application mode will be loaded directly in expert mode. It is then impossible to return to this application program. The user can press the "STOP" button at any time to stop the application quickly. To restart the motor, the program needs to be reloaded.

Once the settings are complete, press the "Load Program" button to configure the motor.

11.5.3.1. Inputs/Outputs Configuration

Refer to the "I/O Connection" section.

Inputs:

- IN1: If 0 → Stop, if 1 → Run
- IN2: If 0 → motor running in reverse (CCW), if 1 → motor running forward (CW)
- IN3: Not used.
- IN4: If 0 → no action, if 1 → Quick start by short-circuiting the coils. This action takes priority over the other commands.
- IN5: 0-10 V control. Sets the motor torque ramp. 20,000 mNm/sec for 0 V (maximum ramp) and 100 mNm/sec for 10 V.
- IN6: 0-10 V control. Sets the torque setpoint. 0V for 0 mNm and 10V for the maximum motor torque defined by the user (value in the grayed-out box).

Outputs: Don't forget to fit the pull-down resistors on each of the outputs.

- OUT1: Provides information on the motor speed value in PWM.  
Cyclical ratio = 0% → speed = 0 rpm  
Cyclical ratio = 100% → speed = 4000 rpm.
- OUT2: Provides information on the real torque value in PWM.  
Cyclical ratio = 0% → torque = 0 mNm  
Cyclical ratio = 100% → torque = maximum torque.
- OUT3: If 0 → motor running, if 1 → motor stopped.
- OUT4: If 0 → error detected, if 1 → no error.

### 11.5.3.2. Application Settings

- The user can give a 4-character name in "Project name" which is stored in the motor and appears in the "Motor Information" window.
- If it has been saved on the PC by the user, this name is used by default. For more details, see the "Saving Parameters" paragraph.
- The maximum motor torque corresponding to a voltage of 10 V is calculated as follows:

$$\text{Consigne Couple Moteur}_{10V} [mNm] = \frac{\text{Force Maxi Serrage} [N]}{\text{Rapport}_{\text{pince/Moteur}} [N/mNm]}$$

The calculated value is given for information in the grayed-out box.

## 11.6. « Dosing » group

### 11.6.1. Application program « Peristaltic pump »

The screenshot shows the DCmind Soft interface for a Peristaltic Pump. The main window is titled 'Peristaltic Pump' and contains several sections:

- Application settings:** Project Name: V201, Flow: 20.00 ml/rotation, Mechanical Ratio: 1.00.
- Dose setting and coding:** A table with columns IN 4, IN 5, Dose, Time, and Speed Motor. It lists four dosing modes (Dose 1 to Dose 4 (10V)) with their respective settings.
- Coding Speed Range:** A table with columns IN4, IN5, Min Speed (rpm), Max Speed (rpm), Min Flow (L/min), and Max Flow (L/min).
- Inputs / Outputs configuration:** A diagram showing input connections (IN1 to IN6) and output connections (OUT1 to OUT4). It includes a 'Dosing' section with 'Go' and 'Dosing 10V' buttons, and an 'Output = + Vcc supply (PNP open collector)' section.
- Monitoring:** A panel on the right showing connection status, temperature (28 °C), Reel Speed (0 rpm), Current Position (-60395), Real Torque (0 mNm), and Power Supply (25.2 V).
- Buttons:** 'Load Program', 'Expert Mode', and a large red 'STOP' button.

The "Peristaltic pump" application program uses a preset V201 expert program.

The user can switch to this expert mode at any time to access all the settings by clicking the "Expert Mode" button.

The values preset in application mode will be loaded directly in expert mode.

It is then impossible to return to this application program.

The user can press the "STOP" button at any time to stop the application quickly.

To restart the motor, the program needs to be reloaded.

Once the settings are complete, press the "Load Program" button to configure the motor.

#### 11.6.1.1. Inputs/Outputs Configuration

Refer to the "I/O Connection" section.

##### Inputs:

- IN1 : ON/OFF      0 → Stop                      1 → ON
- IN2 : Mode              0 → Dosing mode              1 → Flow mode (speed)
- IN3 : Direction / Go
  - In flow mode :                      0 → Motor turns CCW    1 → Motor turns CW
  - In Dosing mode:                      0 → No new dosing    1 → launches a new dose

Note : When Dosing mode is selected, the IN3 signal has to be available during more than 15ms before to be taken in count.
- IN4 + IN 5 : Coding      Codes speed range or dose values depending on selected mode.
- IN6 : Flow / Dose    0/10V analog input.
  - In Flow mode : Adjusts the flow value depending on the flow range selected (IN4 and I N5 coding).

- In Dosing mode: Adjusts D4, the dose to deliver (IN4=IN5=1)

Outputs: Don't forget to fit the pull-down resistors on each of the outputs.

- OUT1 : Mode
  - 0 : Dosing mode
  - 1 : Flow mode
- OUT2 : Direction of rotation
  - 0 : CCW
  - 1 : CW
- OUT3 : Target
  - In Dosing mode : 0 → Dose not completely delivered, 1 → Dose completed
  - In Flow mode: 0 → Motor is running 1 → Motor doesn't move
- OUT4 : Error
  - 0 → No error detected
  - 1 → Error detected

### 11.6.1.2. Application configuration

- The user can give a 4-character name in "Project name" which is stored in the motor and appears in the "Motor Information" window.
- If it has been saved on the PC by the user, this name is used by default. For more details, see the "Saving Parameters" paragraph.
- « Dose », « Time » and « ratio » parameters allow to calculate the motor parameters for each dose (IN4 + IN5) the position to move, speed to deliver the dose. Calculation is as following:

$$Position\ setting\ [Pulses] = \frac{Dose\ [ml] \times 4096}{Flow\ [m.\ tr^{-1}]} \times Ratio$$

$$Speed\ setting\ [RPM] = \frac{Dose\ [ml]}{Flow\ [m.\ tr^{-1}]} \times \frac{60}{Time\ [sec]} \times Ratio$$

For information, for each dose, the calculated speed is in grey boxes.

- For this program, speed ranges are fixed. You could modify them in going in "Expert mode".

IN 4	IN 5	Min. motor speed (rpm)	Max. motor speed (rpm)
0	0	0	3000
1	0	0	1000
0	1	900	2000
1	1	1800	3000

## 12. EXPERT PROGRAMS

### 12.1. Speed Programs

#### 12.1.1. Types of Inputs in V100 Programs

The table below defines the function associated with each of the inputs in the 4 V100 programs (the color associated with the input number corresponds to that of the I/O bundle):

Inputs	Programs			
	V101	V102	V103	V104
In1	ON/OFF	ON/OFF	000 : "In6" setpoint speed 001 : Priority speed 1 010 : Priority speed 2 100 : Priority speed 3	8 combinations: Coding 8 preprogrammed speeds
In2	Direction	Direction		
In3	Holding	Holding		
In4	Fast stop	Fast stop	00 : Fast stop 10 : CCW 01 : CW 11 : Stop, disable error	00 : Fast stop 10 : CCW 01 : CW 11 : Stop, disable error
In5	Speed ramp	Nominal torque	Speed (if In1 = In2 = In3 = 0)	Nominal torque
In6	Speed	Speed		

Key:  Digital type input  
 Analog or PWM type input

#### 12.1.2. Types of Inputs in V200 Programs

The table below defines the function associated with each of the inputs in the 2 V200 programs (the color associated with the input number corresponds to that of the I/O bundle):

Inputs	V201 Speed Mode	V201 Position Mode	V202
E1	ON / OFF	ON / OFF	ON / OFF
E2	Mode	Mode	Direction
E3	Direction	Validation de Consigne	Reverse
E4	00 = Speed Range 1 10 = Speed Range 2 01 = Speed Range 3 11 = Speed Range 4	00 = Position 1 10 = Position 2 01 = Position 3 11 = Position 4	Sensor
E5			Speed Setpoint
E6	Analog Speed Setpoint	Analog Position Setpoint	Position Setpoint



Key:  Digital type input

 Analog or PWM type input

### 12.1.3. Types of Outputs in V100 Programs

For all expert speed programs, 4 configurable output configurations are available (the color associated with the output number corresponds to that of the I/O bundle):

	Out1	Out2	Out3	Out4
Type 1	Hall pulse <i>pulse</i>	Real torque <i>PWM</i>	Direction of rotation <i>Digital</i>	Error <i>Digital</i>
Type 2	Real speed <i>PWM</i>	Real torque <i>PWM</i>	Motor running <i>Digital</i>	Error <i>Digital</i>
Type 3	Real speed <i>Frequency</i>	Direction of rotation <i>Digital</i>	Motor running <i>Digital</i>	Error <i>Digital</i>
Type 4	Real speed (centered on 50%) <i>PWM</i>	Real torque (centered on 50%) <i>PWM</i>	00 : error detected 01 : motor running 10 : motor stopped in holding mode 11 : motor stopped and freewheeling <i>Digital combinations</i>	

Key:  Digital type output  
 PWM/Pulse/Frequency type output

### 12.1.4. Type of outputs in V200 programs

For V200 programs, configurable output configurations is as following (the color associated with the output number corresponds to that of the I/O bundle):

		OUT1	OUT2	OUT3	OUT4
V201 Program	Speed Mode	Type mode <i>Digital</i>	Direction <i>Digital</i>	Motor runs <i>Digital</i>	Error <i>Digital</i>
	Position Mode	Type mode <i>Digital</i>	Direction <i>Digital</i>	Target reached <i>Digital</i>	Error <i>Digital</i>
V202 Program		Target reached <i>Digital</i>	Direction <i>Digital</i>	Motor runs <i>Digital</i>	Error <i>Digital</i>

key :  Digital type output

### 12.1.5. Description of the Various V100 and V200 Tabs

For the description of tabs, expert program V101 is used as an example (for detailed information about each speed expert program, see the "Expert Program V101" to "Expert Program V104" sections in this document).



12.1.5.1. Home Page

This page is common to all the expert and application programs, whether in speed, position or torque mode. It can be used to choose between the various types of application and expert programs.

In our example, we have chosen the "Speed V100" category in the "Expert Programs" group, so the icons for the various V100 expert programs appear in the bottom right-hand corner of the window, and you then need to click on the one corresponding to the "V101" expert program:

Concise description of the V101 expert program

Expert program category selection: V100

Expert program selection: V101

Figure 49

12.1.5.2. "Description" Tab

This is an information tab containing a concise description of the various speed profiles that are created using this expert mode:

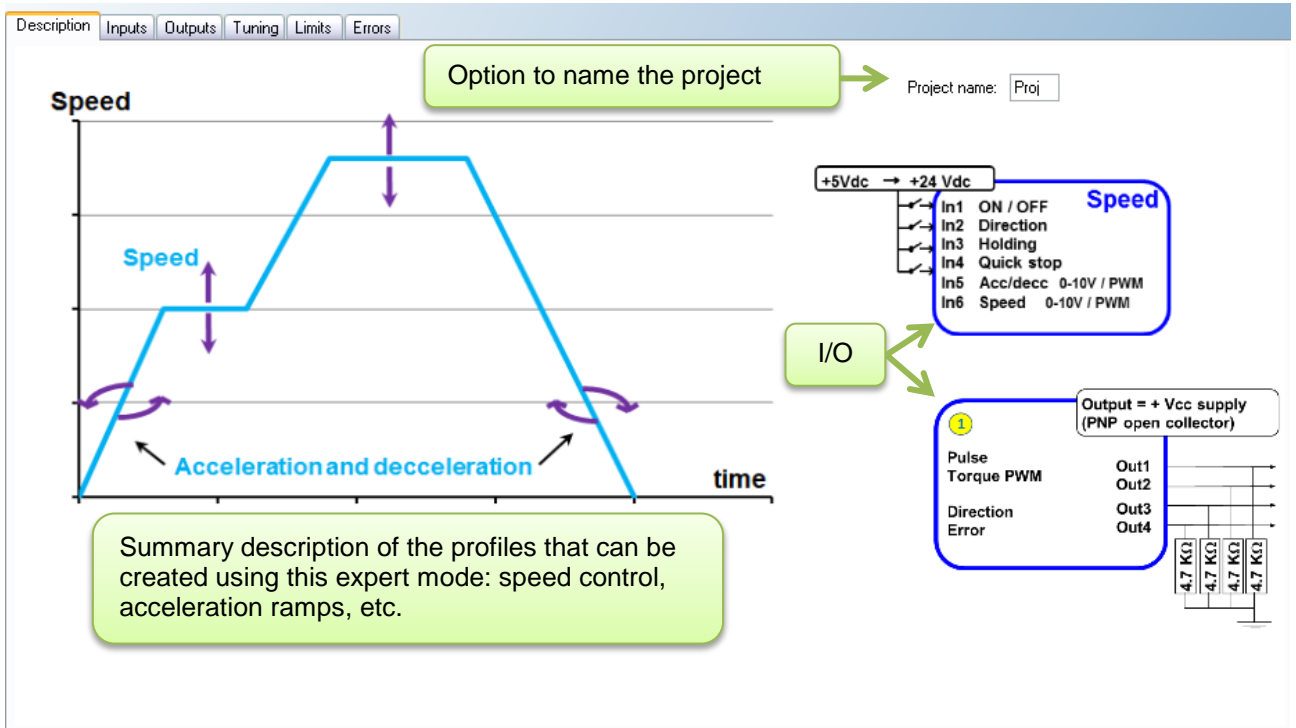
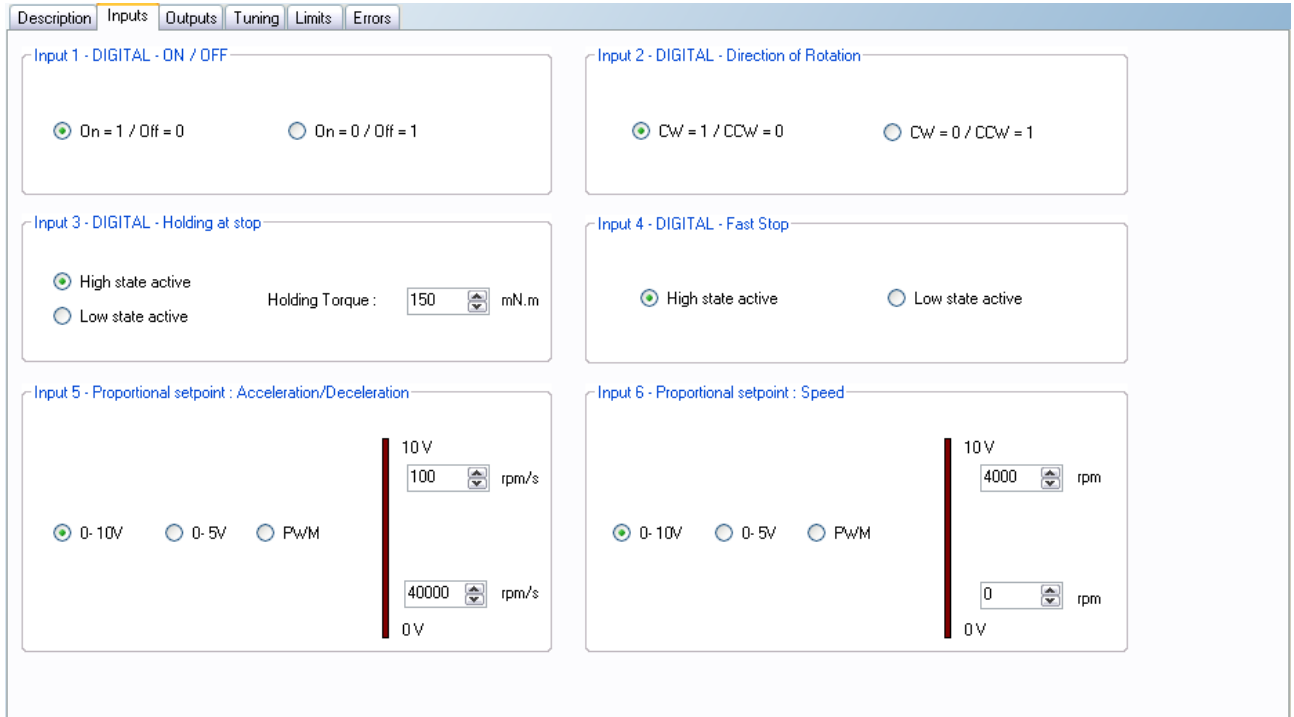


Figure 50

### 12.1.5.3. "Inputs" Tab

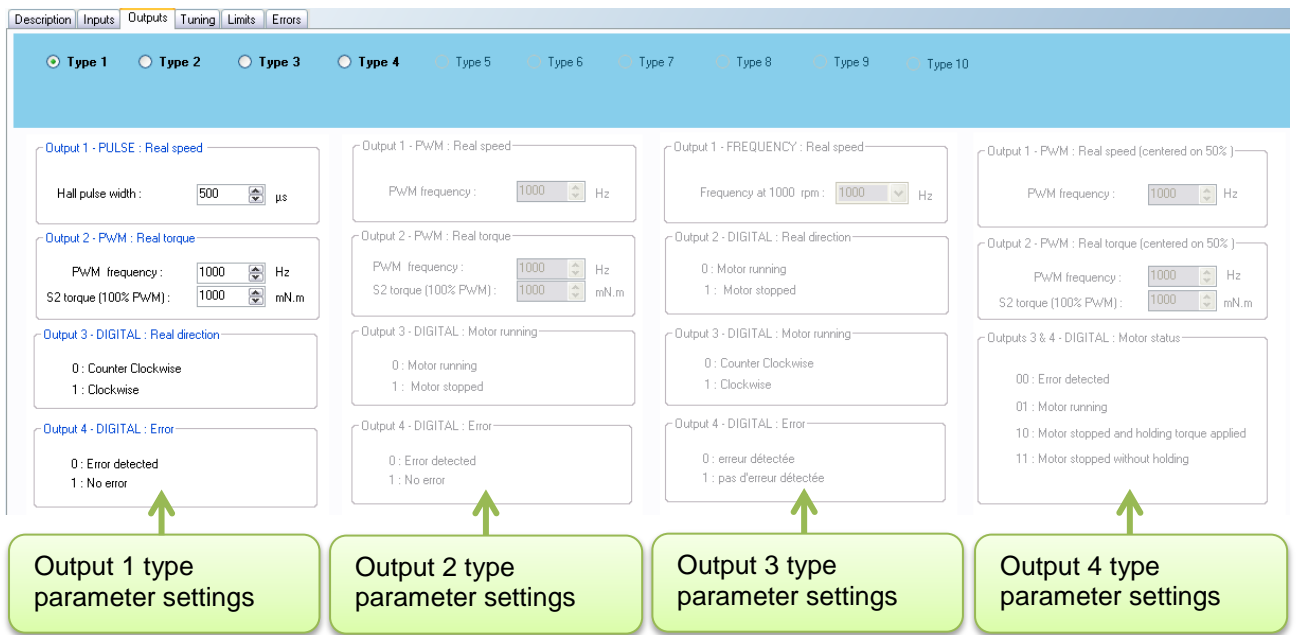
This tab is used to configure the various inputs in this expert mode (digital input polarity, value, control type, maximum and minimum control limit, etc.):



**Figure 51**

### 12.1.5.4. "Outputs" Tab

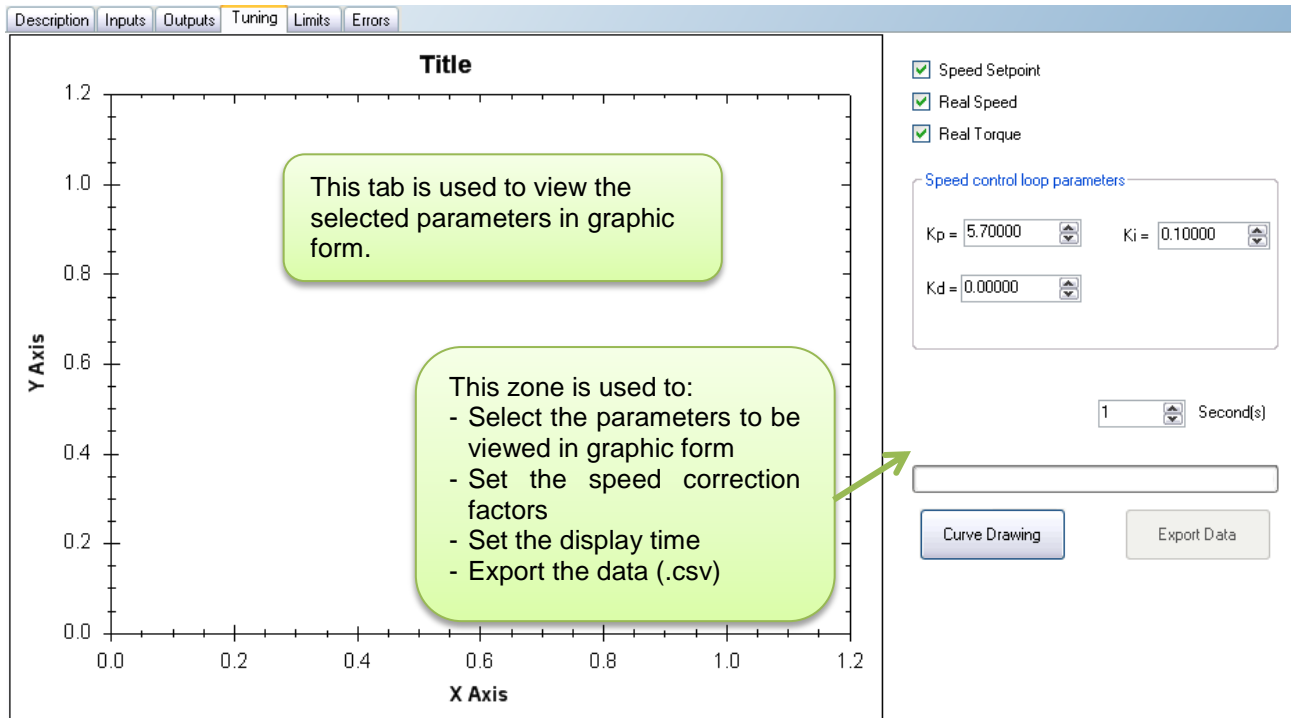
This tab is used to select and configure the various outputs in this expert mode (speed type 1 to type 4):



**Figure 52**

### 12.1.5.5. "Tuning" Tab

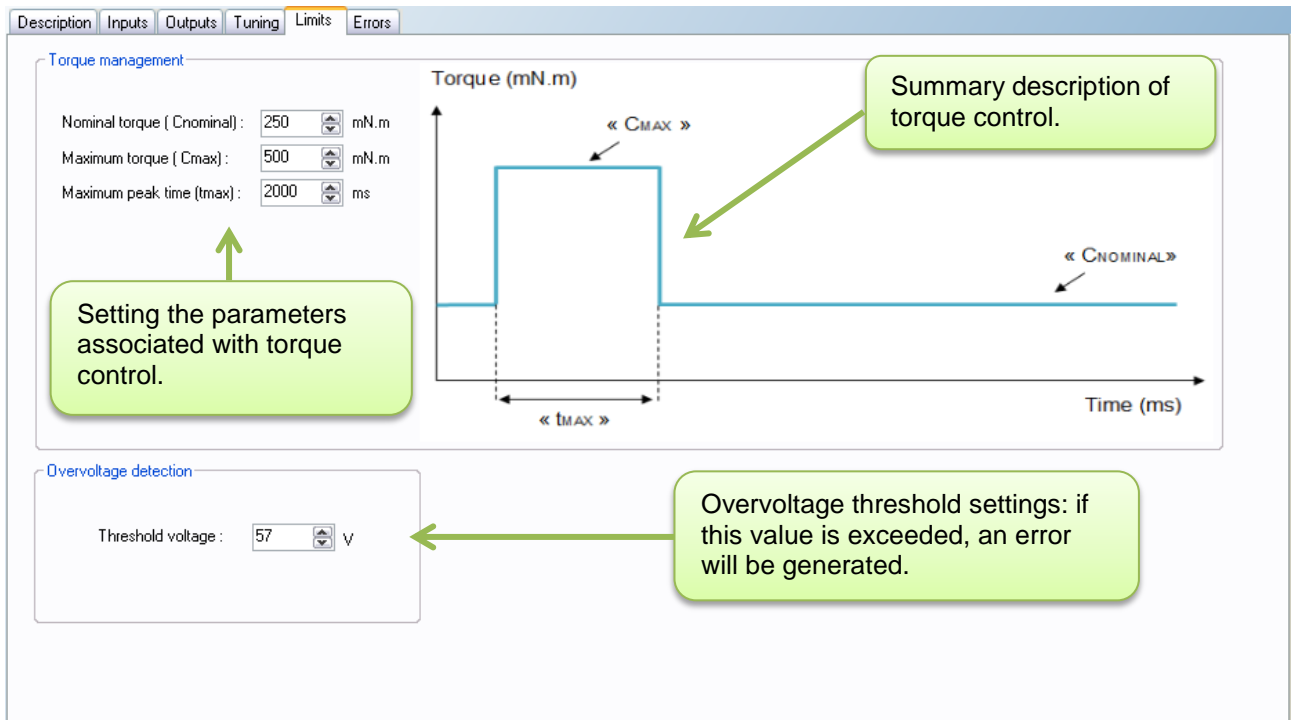
This tab is used to represent some parameters (speed, torque, etc.) in graphic form and modify the speed control loop coefficients. It is common to all the speed expert programs.



**Figure 53**

### 12.1.5.6. "Limits" Tab

This tab is used to configure the various motor operating limits: nominal and maximum torque (torque peak authorization) and the power supply overvoltage threshold.



**Torque management**

Nominal torque (  $C_{nominal}$  ) : 250 mN.m  
 Maximum torque (  $C_{max}$  ) : 500 mN.m  
 Maximum peak time (  $t_{max}$  ) : 2000 ms

**Overvoltage detection**

Threshold voltage : 57 V

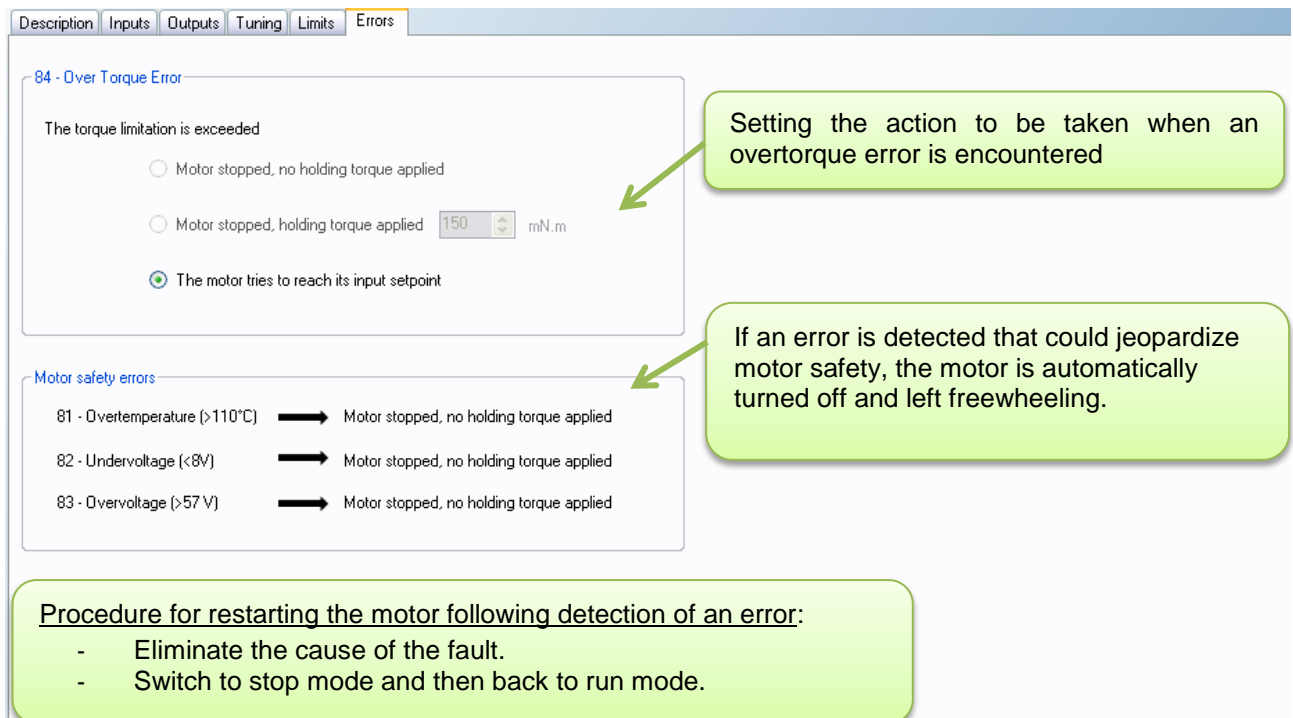
**Setting the parameters associated with torque control.**

**Summary description of torque control.**

**Overvoltage threshold settings: if this value is exceeded, an error will be generated.**

### 12.1.5.7. "Errors" Tab

This tab provides information about the type of error encountered (based on the error code) and the action to be taken by the motor following this error. Action for the over torque error can be configured.



**84 - Over Torque Error**

The torque limitation is exceeded

Motor stopped, no holding torque applied  
 Motor stopped, holding torque applied 150 mN.m  
 The motor tries to reach its input setpoint

**Motor safety errors**

81 - Overtemperature (>110°C) → Motor stopped, no holding torque applied  
 82 - Undervoltage (<8V) → Motor stopped, no holding torque applied  
 83 - Overvoltage (>57 V) → Motor stopped, no holding torque applied

**Setting the action to be taken when an overtorque error is encountered**

**If an error is detected that could jeopardize motor safety, the motor is automatically turned off and left freewheeling.**

**Procedure for restarting the motor following detection of an error:**

- Eliminate the cause of the fault.
- Switch to stop mode and then back to run mode.

12.1.6. Expert Program V101

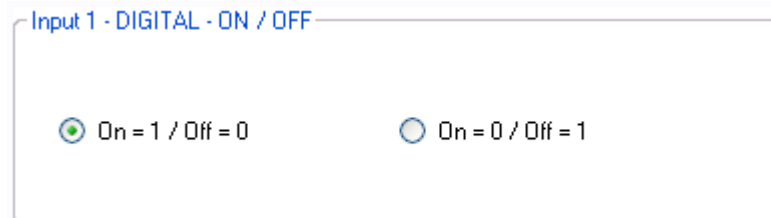
12.1.6.1. Description

Expert program V101 is used to:

- Create speed profiles with analog or PWM control.
- Set the acceleration/deceleration phases with analog or PWM control.
- Set the nominal and maximum torque parameters for the application safety via the HMI.

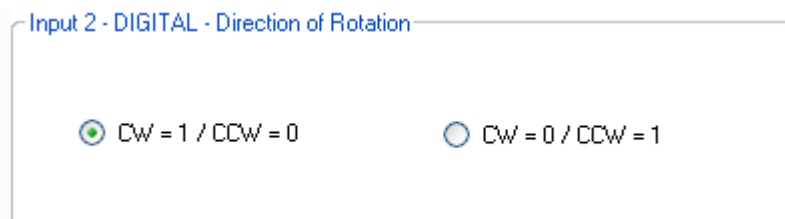
12.1.6.2. "Inputs" Tab Parameters

Digital input 1: Used to set the "On/Off" input polarity.



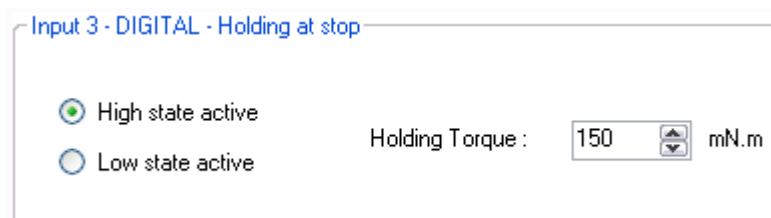
**Figure 54**

Digital input 2: Used to set the "Direction of rotation" input polarity.



**Figure 55**

Digital input 3: Used to set the "Holding at stop" input polarity and set the Holding Torque value.



**Figure 56**

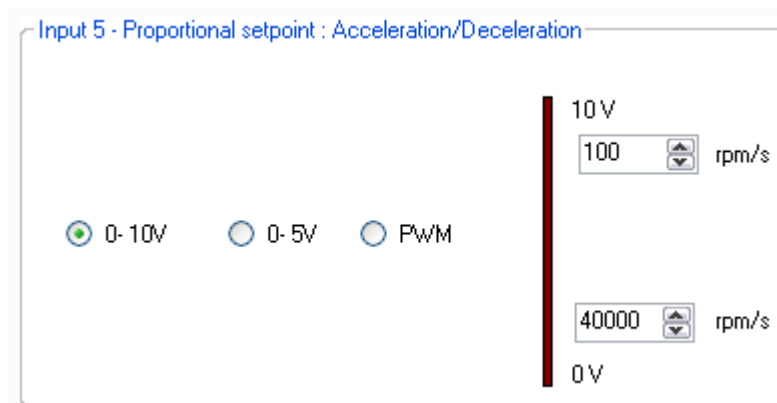
Digital input 4: Used to set the "Fast stop" input polarity.

This input is used to stop the motor as quickly as possible, ignoring the setpoints applied to the other inputs.



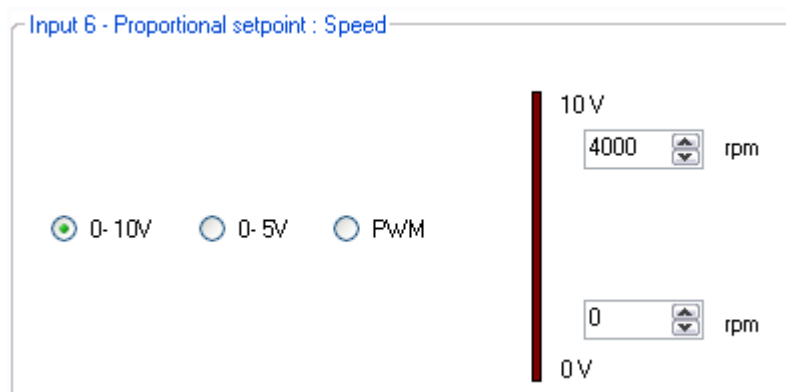
**Figure 57**

Setpoint input 5: Used to select the control type for the acceleration/deceleration setpoint and fix the maximum and minimum limits for this setpoint. An inverted scale can be used.



**Figure 58**

Setpoint input 6: Used to select the control type for the speed setpoint and fix the maximum and minimum limits for this setpoint. An inverted scale can be used.



**Figure 59**

### 12.1.6.3. Type 1 "Outputs" Tab Parameters

Setting the parameters of Pulse output 1 "Real speed": A Hall pulse with configurable width (100 to 800  $\mu$ s) is generated each time one of the 3 motor Hall sensors changes state.

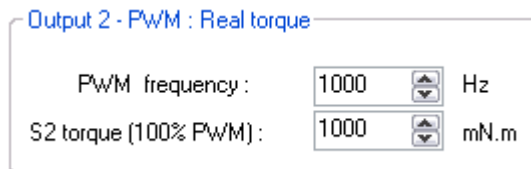
80140\_SMi21 and 80180\_SMi21 motors have 12 Hall pulses per revolution (2 pairs of poles).  
The 80280\_SMi21 motor has 24 Hall pulses per revolution (4 pairs of poles).



**Figure 60**

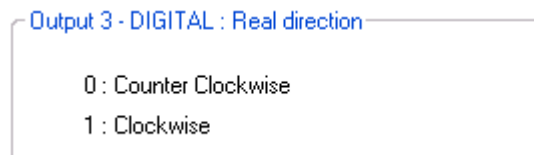
Setting the parameters of PWM output 2 "Real Torque": The parameters can be set for the signal frequency of this output and the torque value corresponding to a cyclical ratio of 100% (scaling).

If cyclical ratio = 0% → Torque supplied = 0 mNm.  
If cyclical ratio = 100% → Torque supplied = "S2 torque".



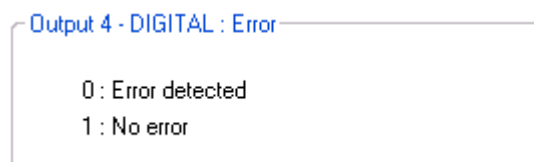
**Figure 61**

State of digital output 3 "Real direction": Used to find out the motor direction of rotation.



**Figure 62**

State of digital output 4 "Error": Used to find out whether an error has been detected.



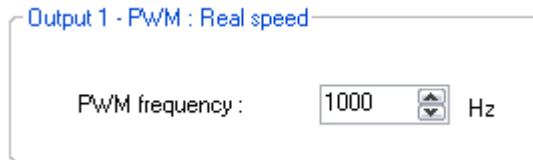
**Figure 63**



12.1.6.4. Type 2 "Outputs" Tab Parameters

Setting the parameters of PWM output 1 "Real Speed": The parameters can be set for the signal frequency of this output (must be identical to the one for PWM output 2).

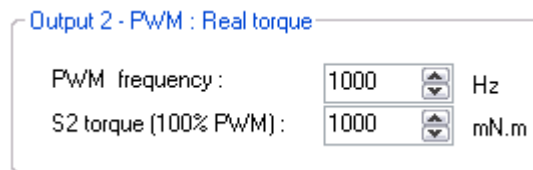
- If cyclical ratio = 0% → Real speed = 0 rpm.
- If cyclical ratio = 100% → Real speed = maximum speed setpoint defined in In6.



**Figure 64**

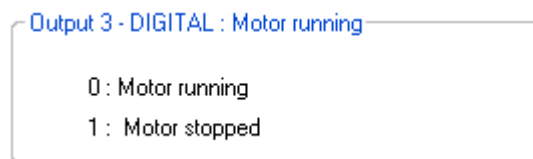
Setting the parameters of PWM output 2 "Real Torque": The parameters can be set for the signal frequency of this output (must be identical to the one for PWM output 1) and the torque value corresponding to a cyclical ratio of 100% (scaling).

- If cyclical ratio = 0% → Torque supplied = 0 mNm.
- If cyclical ratio = 100% → Torque supplied = "S2 torque".



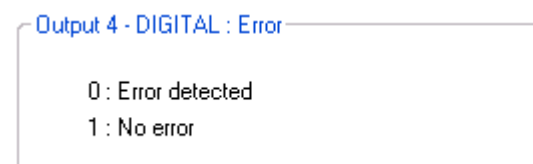
**Figure 65**

State of digital output 3 "Motor running": Used to find out whether the motor is stopped or running.



**Figure 66**

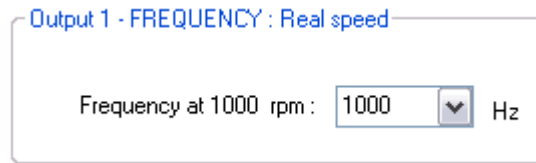
State of digital output 4 "Error": Used to find out whether an error has been detected.



**Figure 67**

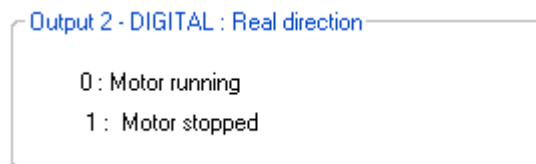
## 12.1.6.5. Type 3 "Outputs" Tab Parameters

Setting the parameters of frequency output 1 "Real speed": The parameters can be set for the signal frequency of this output for which the motor runs at 1000 RPM (200, 500 or 1000 Hz).



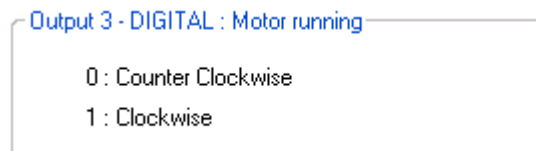
**Figure 68**

State of digital output 2 "Real direction": Used to find out the motor direction of rotation.



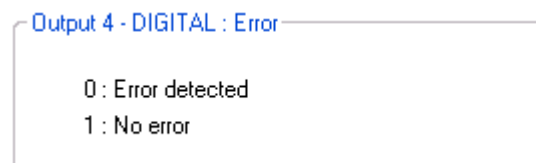
**Figure 69**

State of digital output 3 "Motor running": Used to find out whether the motor is stopped or running.



**Figure 70**

State of digital output 4 "Error": Used to find out whether an error has been detected.

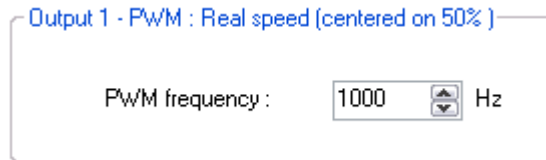


**Figure 71**

## 12.1.6.6. Type 4 "Outputs" Tab Parameters

Setting the parameters of PWM output 1: "Real speed (centered on 50%)": The parameters can be set for the signal frequency of this output (must be identical to the one for PWM output 2).

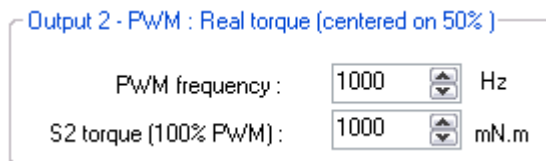
- If cyclical ratio = 0% → Motor running forward (CW) at maximum speed setpoint defined in In6.
- If cyclical ratio = 50% → Real speed = 0 rpm.
- If cyclical ratio = 100% → Motor running in reverse (CCW) at maximum speed setpoint defined in In6.



**Figure 72**

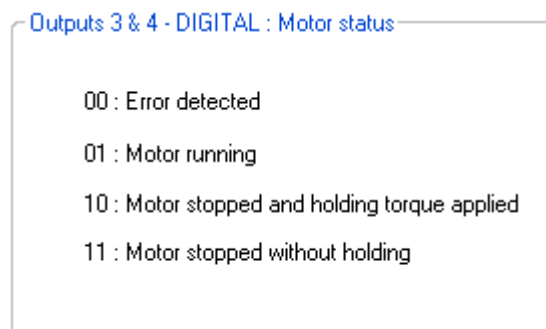
Setting the parameters of PWM output 2 "Real torque (centered on 50%)": The parameters can be set for the signal frequency of this output (must be identical to the one for PWM output 1) and the torque value corresponding to a cyclical ratio of 100% (scaling).

- If cyclical ratio = 0% → Braking torque supplied = "S2 torque".
- If cyclical ratio = 50% → Torque supplied = 0 mNm.
- If cyclical ratio = 100% → Motor torque supplied = "S2 torque".



**Figure 73**

Combinations of digital outputs 3 & 4 "Motor status": Used to find out the motor status.



**Figure 74**

12.1.6.7. "Tuning" Tab Parameters

Selection of the various parameters to be represented in graphic form: either 1, 2 or 3 parameters. The system speed response (measurement vs setpoint) can therefore be compared while displaying changes in the current.

- Speed Setpoint
- Real Speed
- Real Torque

**Figure 75**

Set the PID controller factors in the speed control loop (this function is reserved for advanced users). The values given in the example below ensure correct product operation in the majority of cases.

Speed control loop parameters

K<sub>p</sub> = 5.70000      K<sub>i</sub> = 0.10000

K<sub>d</sub> = 0.00000

**Figure 76**

It is possible to set the recording time you wish to view, from 1 to 300 seconds. The sampling interval is 10 ms. During data acquisition, the other HMI functions are not available.

10      Second(s)

**Figure 77**

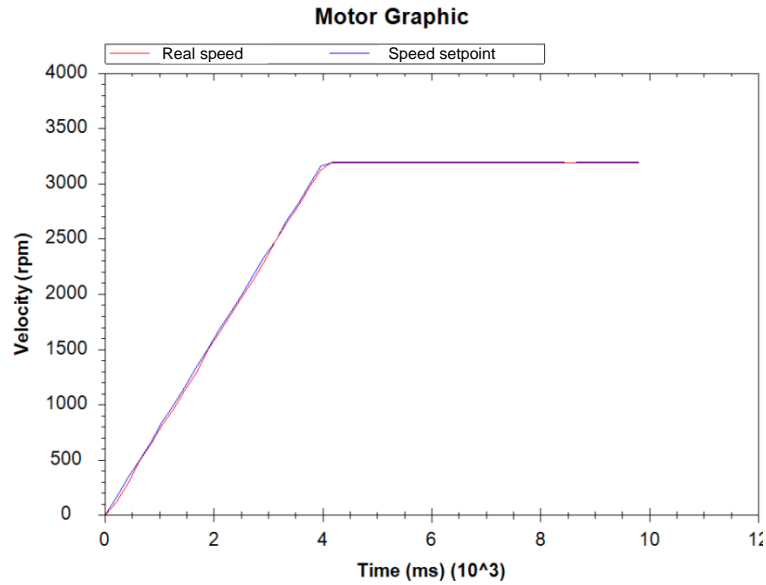
"Curve Drawing" button: used to start data acquisition. Curves are only displayed once acquisition is complete.

"Export Data" button: used to retrieve data corresponding to the selected parameters in a text file (.txt). To make this file compatible with the Excel spreadsheet, change its extension to .csv.

Curve Drawing      Export Data

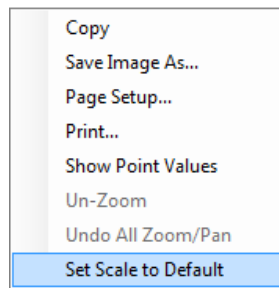
**Figure 78**

Example: With a speed setpoint on input 6 at 3200 RPM and an acceleration setpoint on input 5 at 800 RPM/s, this gives us the following graphic representation (recording time of 10 seconds):



**Figure 79**

Note: The display scales can be changed with the mouse wheel. Other functions are available by right-clicking the mouse.



**Figure 80**

12.1.6.8. "Limitations" Tab Parameters

**! WARNING**

**UNEXPECTED MOVEMENT**  
An inappropriate setting for the torque values can result in unexpected movements of the application and destruction of the motor.

- Make sure this will not cause any damage.
- Do not continue with the test if there is anyone or any obstacle in the hazardous zone.

**Failure to comply with these precautions will result in death, serious injury or equipment damage.**

This tab can be used to set the limit values for various parameters.

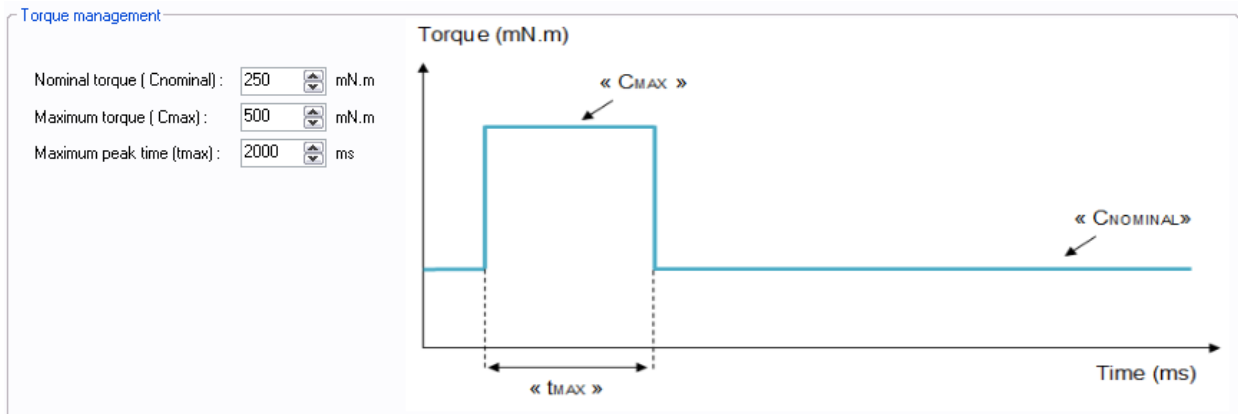


Figure 81

Setting the various torque parameters: When the application torque exceeds the torque "C<sub>NOMINAL</sub>", the motor can provide torque up to the value "C<sub>MAX</sub>" for the maximum duration "t<sub>MAX</sub>". Thereafter, if the application torque is still higher than "C<sub>NOMINAL</sub>", the motor torque is limited to the value "C<sub>NOMINAL</sub>" until the application torque falls back below this value.

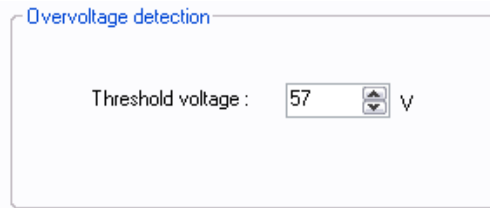
**! WARNING**

**VOLTAGE SURGES**  
During the braking phases, the motor generates voltage surges.

- Check that its voltage surges can be tolerated by the other devices connected to the same power supply.
- Use an external circuit to limit voltage surges if the brake is being used intensively.

**Failure to comply with these precautions will result in death, serious injury or equipment damage.**

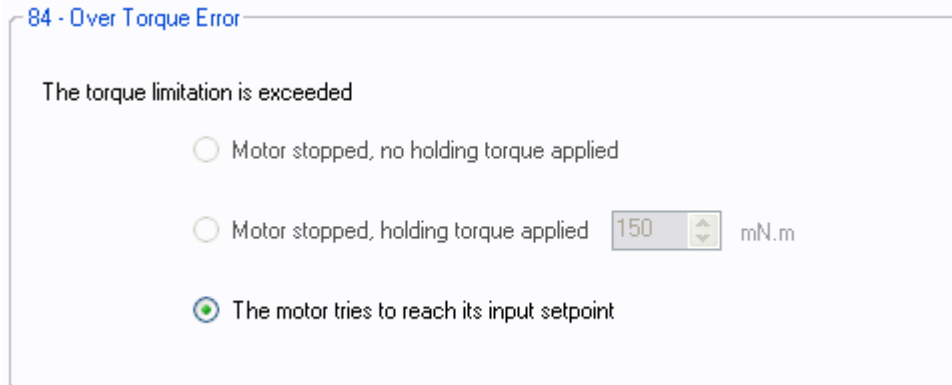
Setting the overvoltage detection threshold parameters: If the voltage at the motor terminals exceeds this threshold, an error is generated, the motor is stopped and no holding torque is applied (freewheeling).



**Figure 82**

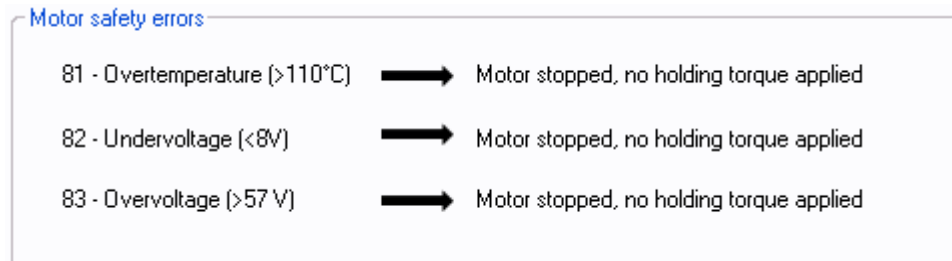
### 12.1.6.9. "Errors" Tab Parameters

Setting the parameters for the action to be taken when an overtorque error is encountered: real torque higher than the nominal torque "C<sub>NOMINAL</sub>" for a time longer than "t<sub>MAX</sub>".



**Figure 83**

For all errors affecting motor safety, the action to be taken cannot be configured: in the event of an error, the motor is stopped and no holding torque is applied (freewheeling).



**Figure 84**

#### Procedure for restarting the motor following detection of an error:

- Eliminate the cause of the fault.
- Switch to stop mode: disable digital input 1 "On/Off".
- Switch back to run mode: enable digital input 1 "On/Off".

12.1.7. Expert Program V102

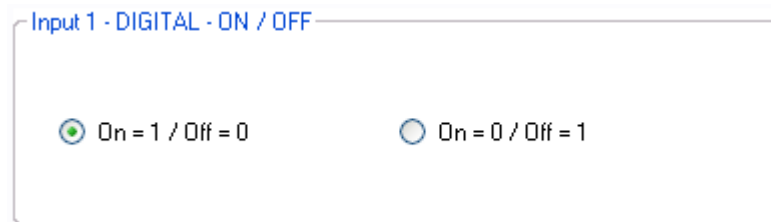
12.1.7.1. Description

Expert program V102 is used to:

- Create speed profiles with analog or PWM control.
- Set torque limiting with analog or PWM control.

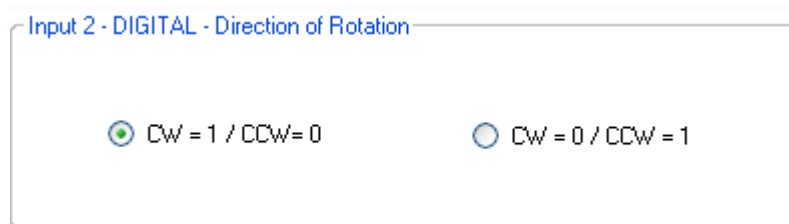
12.1.7.2. "Inputs" Tab Parameters

Digital input 1: Used to set the "On/Off" input polarity.



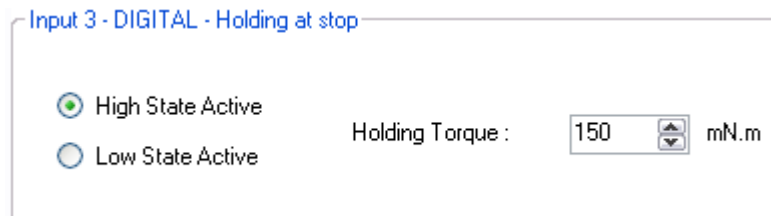
**Figure 85**

Digital input 2: Used to set the "Direction of rotation" input polarity.



**Figure 86**

Digital input 3: Used to set the "Holding at stop" input polarity and set the Holding Torque value.



**Figure 87**



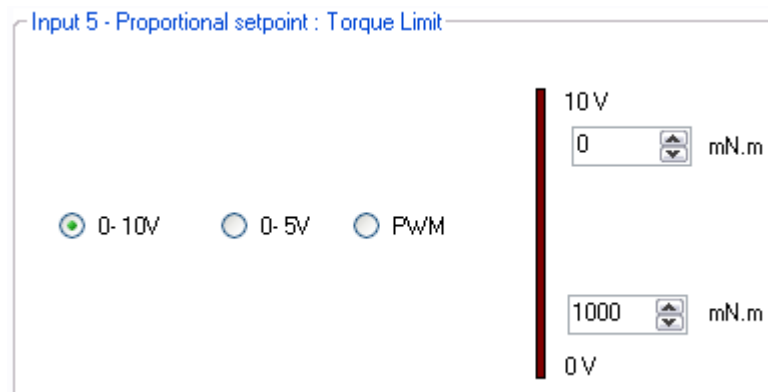
Digital input 4: Used to set the "Fast stop" input polarity.

This input is used to stop the motor as quickly as possible, ignoring the setpoints applied to the other inputs.



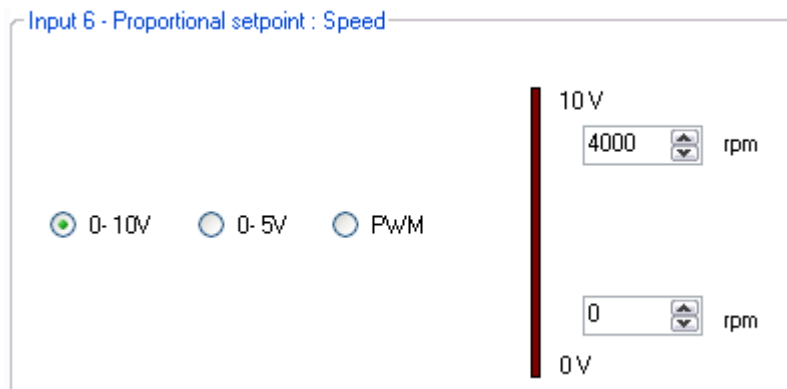
**Figure 88**

Setpoint input 5: Used to select the control type for the torque limiting setpoint and fix the maximum and minimum limits for this setpoint. An inverted scale can be used.



**Figure 89**

Setpoint input 6: Used to select the control type for the speed setpoint and fix the maximum and minimum limits for this setpoint. An inverted scale can be used.



**Figure 90**

### 12.1.7.3. Type 1 "Outputs" Tab Parameters

Setting the parameters of Pulse output 1 "Real speed": A Hall pulse with configurable width (100 to 800  $\mu$ s) is generated each time one of the 3 motor Hall sensors changes state.

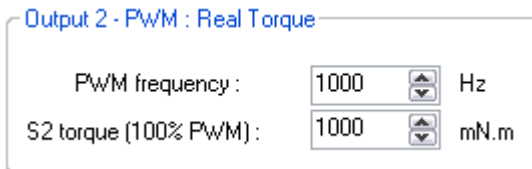
80140\_SMi21 and 80180\_SMi21 motors have 12 Hall pulses per revolution (2 pairs of poles).  
The 80280\_SMi21 motor has 24 Hall pulses per revolution (4 pairs of poles).



**Figure 91**

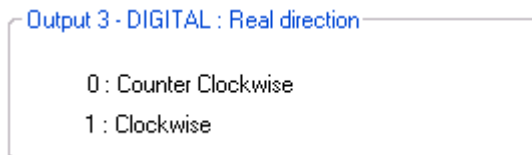
Setting the parameters of PWM output 2 "Real Torque": The parameters can be set for the signal frequency of this output and the torque value corresponding to a cyclical ratio of 100% (scaling).

If cyclical ratio = 0% → Torque supplied = 0 mNm.  
If cyclical ratio = 100% → Torque supplied = "S2 torque".



**Figure 92**

State of digital output 3 "Real direction": Used to find out the motor direction of rotation.



**Figure 93**

State of digital output 4 "Error": Used to find out whether an error has been detected.



**Figure 94**

12.1.7.4. Type 2 "Outputs" Tab Parameters

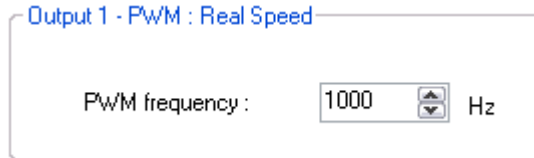
Setting the parameters of PWM output 1 "Real Speed": The parameters can be set for the signal frequency of this output (must be identical to the one for PWM output 2).

If cyclical ratio = 0%

→ Real speed = 0 rpm.

If cyclical ratio = 100%

→ Real speed = maximum speed setpoint defined in In6.



**Figure 95**

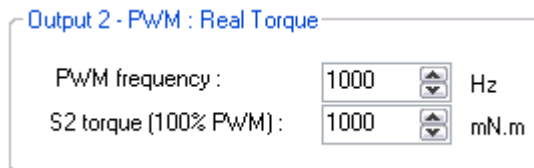
Setting the parameters of PWM output 2 "Real Torque": The parameters can be set for the signal frequency of this output (must be identical to the one for PWM output 1) and the torque value corresponding to a cyclical ratio of 100% (scaling).

If cyclical ratio = 0%

→ Torque supplied = 0 mNm.

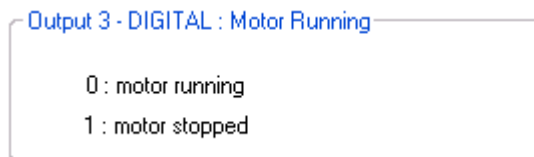
If cyclical ratio = 100%

→ Torque supplied = "S2 torque".



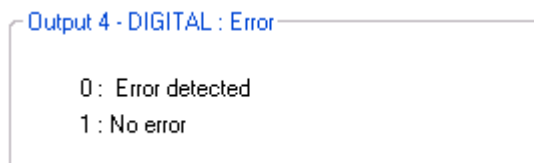
**Figure 96**

State of digital output 3 "Motor Running": Used to find out whether the motor is stopped or running.



**Figure 97**

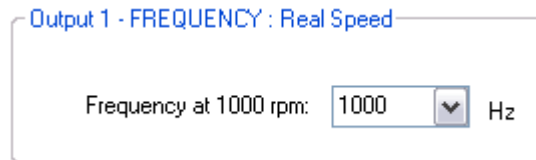
State of digital output 4 "Error": Used to find out whether an error has been detected.



**Figure 98**

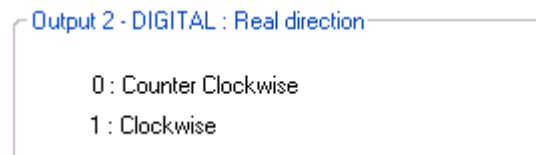
## 12.1.7.5. Type 3 "Outputs" Tab Parameters

Setting the parameters of frequency output 1 "Real speed": The parameters can be set for the signal frequency of this output for which the motor runs at 1000 RPM (200, 500 or 1000 Hz).



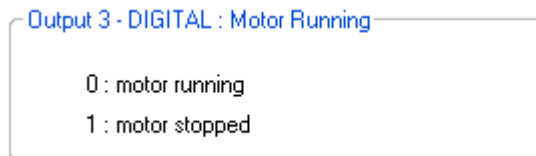
**Figure 99**

State of digital output 2 "Real direction": Used to find out the motor direction of rotation.



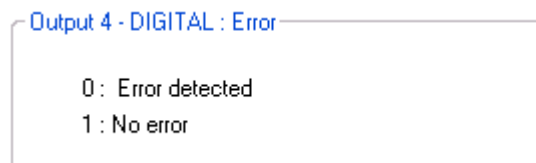
**Figure 100**

State of digital output 3 "Motor Running": Used to find out whether the motor is stopped or running.



**Figure 101**

State of digital output 4 "Error": Used to find out whether an error has been detected.

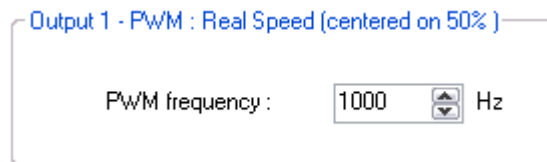


**Figure 102**

## 12.1.7.6. Type 4 "Outputs" Tab Parameters

Setting the parameters of PWM output 1: "Real speed (centered on 50%)": The parameters can be set for the signal frequency of this output (must be identical to the one for PWM output 2).

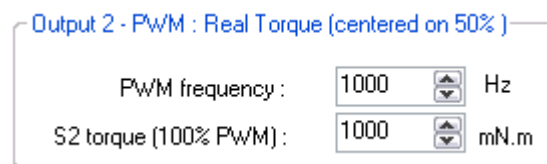
- If cyclical ratio = 0% → Motor running forward (CW) at maximum speed setpoint defined in In6.
- If cyclical ratio = 50% → Real speed = 0 rpm.
- If cyclical ratio = 100% → Motor running in reverse (CCW) at maximum speed setpoint defined in In6.



**Figure 103**

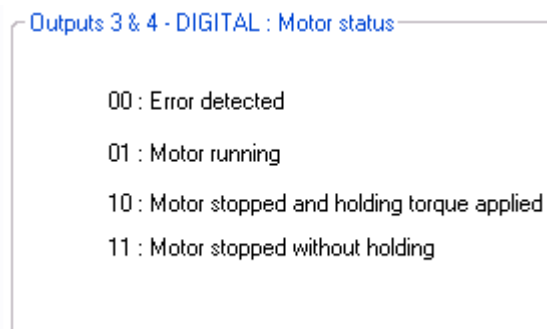
Setting the parameters of PWM output 2 "Real torque (centered on 50%)": The parameters can be set for the signal frequency of this output (must be identical to the one for PWM output 1) and the torque value corresponding to a cyclical ratio of 100% (scaling).

- If cyclical ratio = 0% → Braking torque supplied = "S2 torque".
- If cyclical ratio = 50% → Torque supplied = 0 mNm.
- If cyclical ratio = 100% → Motor torque supplied = "S2 torque".



**Figure 104**

Combinations of digital outputs 3 & 4 "Motor status": Used to find out the motor status.



**Figure 105**

12.1.7.7. "Tuning" Tab Parameters

Selection of the various parameters to be represented in graphic form: either 1, 2 or 3 parameters. The system speed response (measurement vs setpoint) can therefore be compared while displaying changes in the current.

- Speed Setpoint
- Real Speed
- Real Torque

**Figure 106**

Set the PID controller factors in the speed control loop (this function is reserved for advanced users). The values given in the example below ensure correct product operation in the majority of cases.

Speed control loop parameters

Kp = 5.70000      Ki = 0.10000

Kd = 0.00000

**Figure 107**

It is possible to set the recording time you wish to view, from 1 to 300 seconds. The sampling interval is 10 ms. During data acquisition, the other HMI functions are not available.

Recording time : 10 Second(s)

\_\_\_\_\_

**Figure 108**

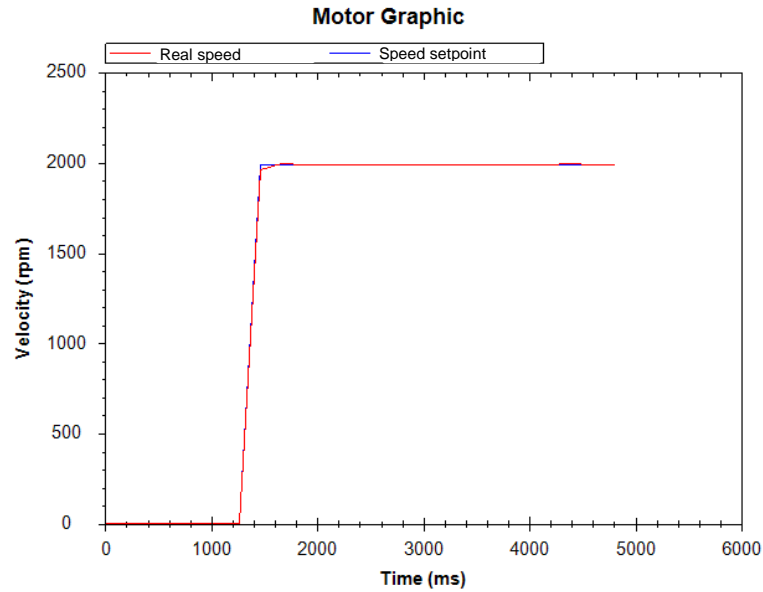
"Curve Drawing" button: used to start data acquisition. Curves are only displayed once acquisition is complete.

"Export Data" button: used to retrieve data corresponding to the selected parameters in a text file (.txt). To make this file compatible with the Excel spreadsheet, change its extension to .csv.

Curve Drawing      Export Data

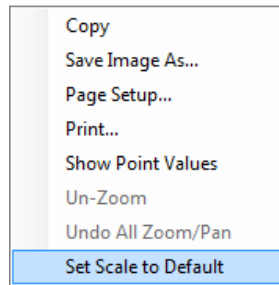
**Figure 109**

Example: With a speed setpoint on input 6 at 2000 RPM and a torque limit on input 5 at 1000 mN.m, this gives us the following graphic representation (recording time of 5 seconds):




**Figure 110**

Note: The display scales can be changed with the mouse wheel. Other functions are available by right-clicking the mouse.



**Figure 111**

### 12.1.7.8. "Limits" Tab Parameters

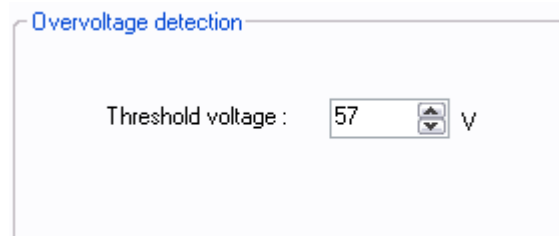
 **WARNING**

**VOLTAGE SURGES**  
During the braking phases, the motor generates voltage surges.

- Check that its voltage surges can be tolerated by the other devices connected to the same power supply.
- Use an external circuit to limit voltage surges if the brake is being used intensively.

**Failure to comply with these precautions will result in death, serious injury or equipment damage.**

Setting the overvoltage detection threshold parameters: If the voltage at the motor terminals exceeds this threshold, an error is generated, the motor is stopped and no holding torque is applied (freewheeling).



**Figure 112**

### 12.1.7.9. "Errors" Tab Parameters

For all errors affecting motor safety, the action to be taken cannot be configured: in the event of an error, the motor is stopped and no holding torque is applied (freewheeling).

Motor safety errors		
81 - Overtemperature (>110°C)	➔	Motor stopped, no holding torque applied
82 - Undervoltage (<8V)	➔	Motor stopped, no holding torque applied
83 - Overvoltage (>57V)	➔	Motor stopped, no holding torque applied

**Figure 113**

Procedure for restarting the motor following detection of an error:

- Eliminate the cause of the fault.
- Switch to stop mode: disable digital input 1 "On/Off".
- Switch back to run mode: enable digital input 1 "On/Off".



12.1.8. Expert Program V103

12.1.8.1. Description

Expert program V103 is used to:

- Create speed profiles with analog or PWM control.
- Force speed control to one of the 3 preprogrammed speeds.
- Set the acceleration/deceleration phase parameters via the HMI.

12.1.8.2. "Inputs" Tab Parameters

Combinations of digital inputs 1 to 3: Used to choose the type of speed setpoint applied at the motor input:

- If no input is active, the setpoint will be that applied to input 6.
- If one of these 3 inputs is active, the setpoint will be the priority speed associated with this input.

N.B.: If more than 1 input In1 to In3 is active, the setpoint taken into account will be that for input 6.

Inputs 1, 2, 3 - DIGITAL : Choose speed setpoint

IN1	IN2	IN3	
<input type="checkbox"/>	<input type="checkbox"/>	<input type="checkbox"/>	Speed setpoint Input 6
<input type="checkbox"/>	<input type="checkbox"/>	<input type="checkbox"/>	Speed n°1 <input type="text" value="1000"/> rpm
<input type="checkbox"/>	<input type="checkbox"/>	<input type="checkbox"/>	Speed n°2 <input type="text" value="2000"/> rpm
<input type="checkbox"/>	<input type="checkbox"/>	<input type="checkbox"/>	Speed n°3 <input type="text" value="3000"/> rpm

Figure 114

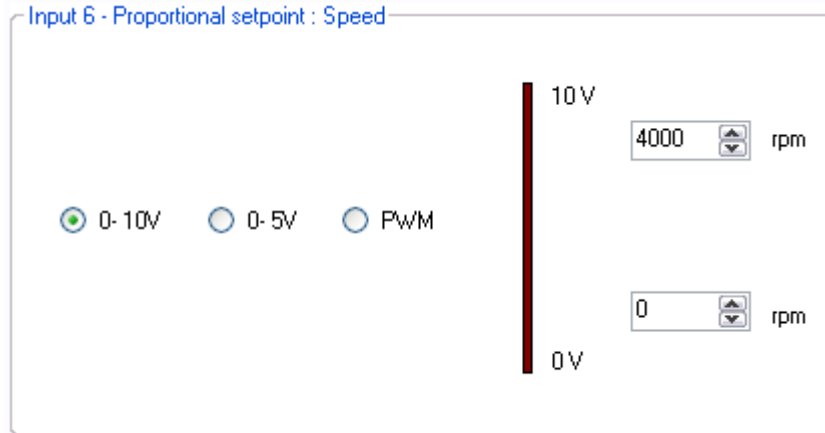
Combinations of digital inputs 4 and 5: Used to choose the motion to be performed from the 4 actions indicated below.

Inputs 4, 5 - DIGITAL : Choose motion

IN4	IN5	
<input type="checkbox"/>	<input type="checkbox"/>	Fast stop
<input type="checkbox"/>	<input type="checkbox"/>	CCW direction
<input type="checkbox"/>	<input type="checkbox"/>	CW direction
<input type="checkbox"/>	<input type="checkbox"/>	Stop and remove error

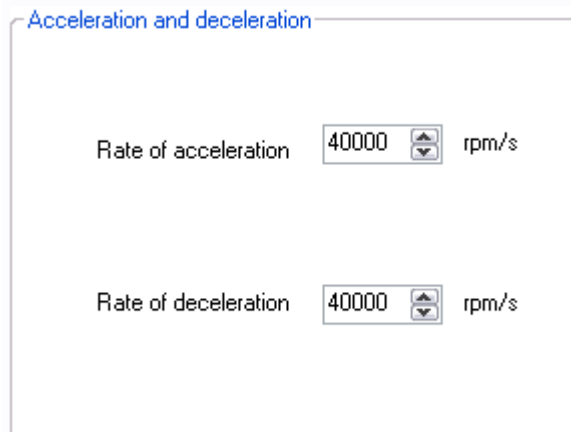
Figure 115

Setpoint input 6: Used to select the control type for the speed setpoint and fix the maximum and minimum limits for this setpoint. An inverted scale can be used.



**Figure 116**

Setting the acceleration and braking ramps: These values are fixed via the HMI and cannot be changed by inputs while the motor is running. By default, the rates are fixed at 40,000 RPM/sec.

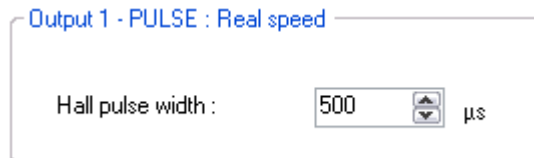


**Figure 117**

### 12.1.8.3. Type 1 "Outputs" Tab Parameters

Setting the parameters of Pulse output 1 "Real speed": A Hall pulse with configurable width (100 to 800  $\mu$ s) is generated each time one of the 3 motor Hall sensors changes state.

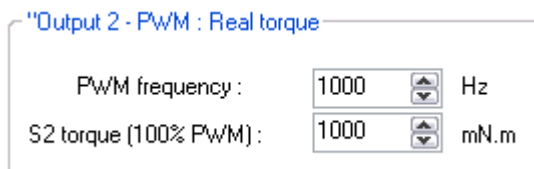
80140\_SMi21 and 80180\_SMi21 motors have 12 Hall pulses per revolution (2 pairs of poles).  
The 80280\_SMi21 motor has 24 Hall pulses per revolution (4 pairs of poles).



**Figure 118**

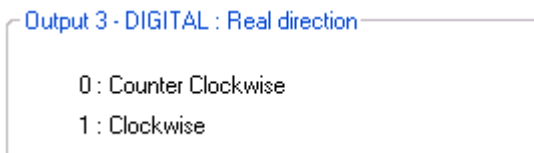
Setting the parameters of PWM output 2 "Real torque": The parameters can be set for the signal frequency of this output and the torque value corresponding to a cyclical ratio of 100% (scaling).

If cyclical ratio = 0% → Torque supplied = 0 mNm.  
If cyclical ratio = 100% → Torque supplied = "S2 torque".



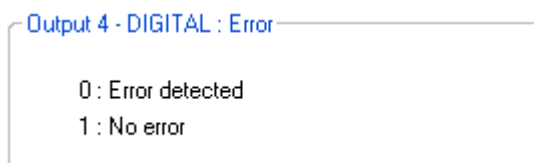
**Figure 119**

State of digital output 3 "Real direction": Used to find out the motor direction of rotation.



**Figure 120**

State of digital output 4 "Error": Used to find out whether an error has been detected.



**Figure 121**

12.1.8.4. Type 2 "Outputs" Tab Parameters

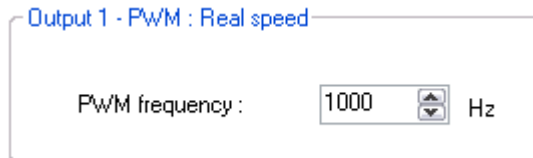
Setting the parameters of PWM output 1 "Real speed": The parameters can be set for the signal frequency of this output (must be identical to the one for PWM output 2).

If cyclical ratio = 0%

→ Real speed = 0 rpm.

If cyclical ratio = 100%

→ Real speed = maximum speed setpoint defined in In6.



**Figure 122**

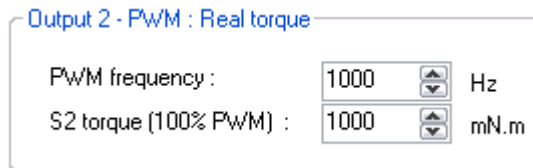
Setting the parameters of PWM output 2 "Real torque": The parameters can be set for the signal frequency of this output (must be identical to the one for PWM output 1) and the torque value corresponding to a cyclical ratio of 100% (scaling).

If cyclical ratio = 0%

→ Torque supplied = 0 mNm.

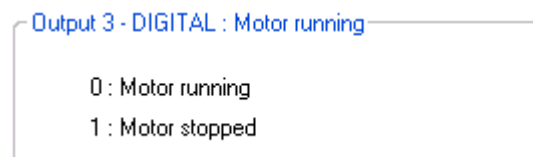
If cyclical ratio = 100%

→ Torque supplied = "S2 torque".



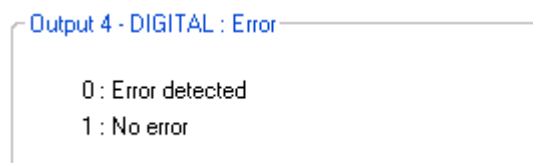
**Figure 123**

State of digital output 3 "Motor running": Used to find out whether the motor is stopped or running.



**Figure 124**

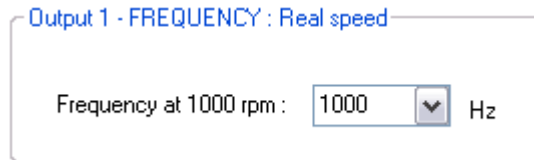
State of digital output 4 "Error": Used to find out whether an error has been detected.



**Figure 125**

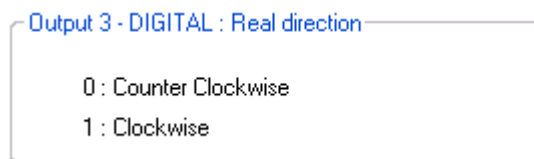
## 12.1.8.5. Type 3 "Outputs" Tab Parameters

Setting the parameters of frequency output 1 "Real speed": The parameters can be set for the signal frequency of this output for which the motor runs at 1000 RPM (200, 500 or 1000 Hz).



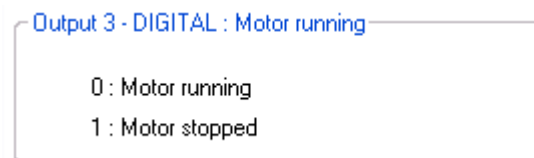
**Figure 126**

State of digital output 2 "Real direction": Used to find out the motor direction of rotation.



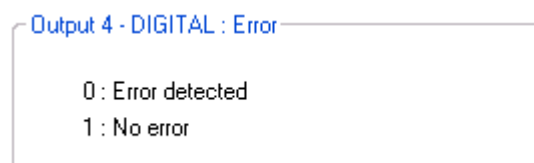
**Figure 127**

State of digital output 3 "Motor running": Used to find out whether the motor is stopped or running.



**Figure 128**

State of digital output 4 "Error": Used to find out whether an error has been detected.

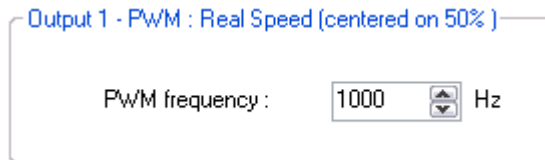


**Figure 129**

12.1.8.6. Type 4 "Outputs" Tab Parameters

Setting the parameters of PWM output 1: "Real speed (centered on 50%)": The parameters can be set for the signal frequency of this output (must be identical to the one for PWM output 2).

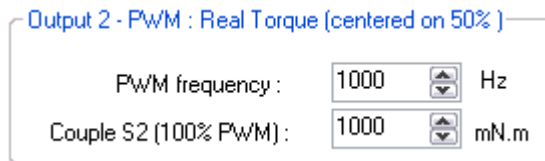
- If cyclical ratio = 0% → Motor running forward (CW) at maximum speed setpoint defined in In6.
- If cyclical ratio = 50% → Real speed = 0 rpm.
- If cyclical ratio = 100% → Motor running in reverse (CCW) at maximum speed setpoint defined in In6.



**Figure 130**

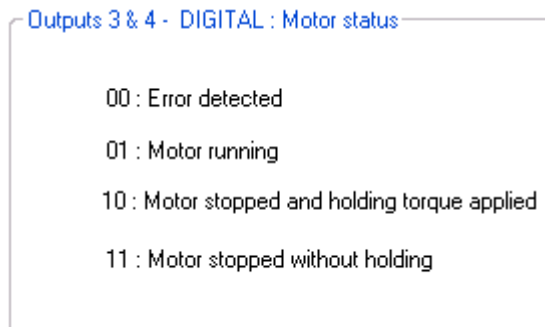
Setting the parameters of PWM output 2 "Real torque (centered on 50%)": The parameters can be set for the signal frequency of this output (must be identical to the one for PWM output 1) and the torque value corresponding to a cyclical ratio of 100% (scaling).

- If cyclical ratio = 0% → Braking torque supplied = "S2 torque".
- If cyclical ratio = 50% → Torque supplied = 0 mNm.
- If cyclical ratio = 100% → Motor torque supplied = "S2 torque".



**Figure 131**

Combinations of digital outputs 3 & 4 "Motor status": Used to find out the motor status.



**Figure 132**

12.1.8.7. "Tuning" Tab Parameters

Selection of the various parameters to be represented in graphic form: either 1, 2 or 3 parameters. The system speed response (measurement vs setpoint) can therefore be compared while displaying changes in the current.

- Speed setpoint
- Real speed
- Real torque

**Figure 133**

Set the PID controller factors in the speed control loop (this function is reserved for advanced users). The values given in the example below ensure correct product operation in the majority of cases.

Speed control loop parameters

Kp =       Ki =

Kd =

**Figure 134**

It is possible to set the recording time you wish to view, from 1 to 300 seconds. The sampling interval is 10 ms. During data acquisition, the other HMI functions are not available.

Recording time :

Second(s)

---

**Figure 135**

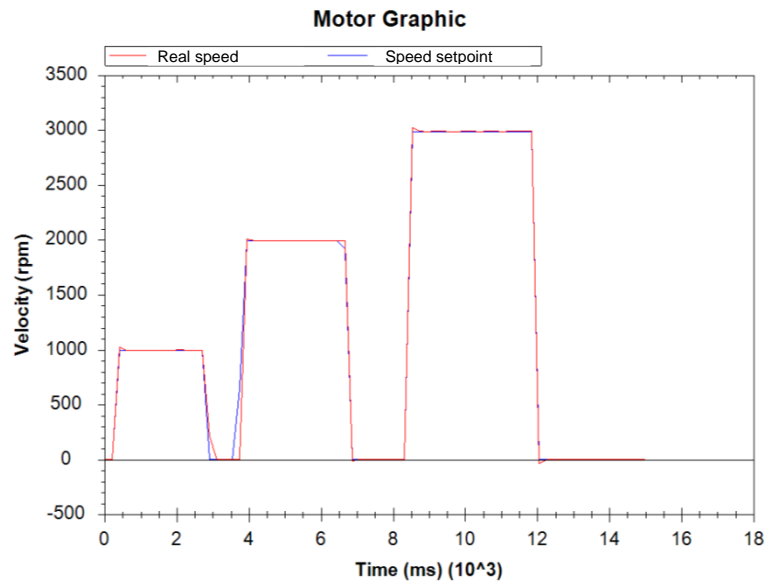
"Curve Drawing" button: used to start data acquisition. Curves are only displayed once acquisition is complete.

"Export Data" button: used to retrieve data corresponding to the selected parameters in a text file (.txt). To make this file compatible with the Excel spreadsheet, change its extension to .csv.



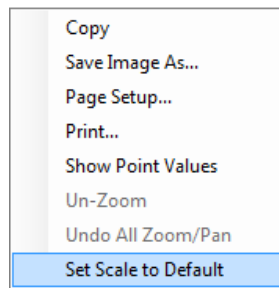
**Figure 136**

Example: With a priority speed on input 1 at 1000 RPM, a priority speed on input 2 at 2000 RPM and a priority speed on input 3 at 3000 RPM, this gives us the following graphic representation (recording time of 10 seconds):



**Figure 137**


Note: The display scales can be changed with the mouse wheel. Other functions are available by right-clicking the mouse.



**Figure 138**



12.1.8.8. "Limits" Tab Parameters

 **WARNING**

**UNEXPECTED MOVEMENT**  
An inappropriate setting for the torque values can result in unexpected movements of the application and destruction of the motor.

- Make sure this will not cause any damage.
- Do not continue with the test if there is anyone or any obstacle in the hazardous zone.

**Failure to comply with these precautions will result in death, serious injury or equipment damage.**

This tab can be used to set the limit values for various parameters.

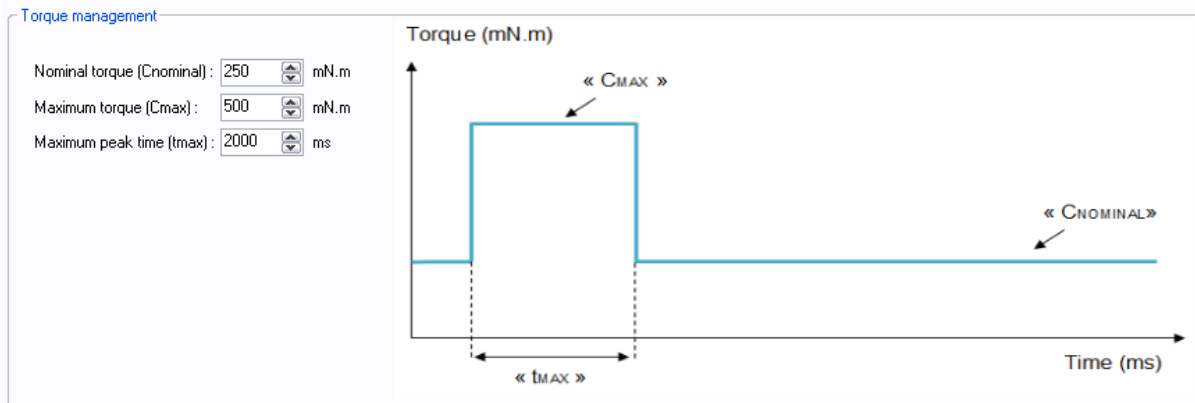



Figure 139

Setting the various torque parameters: When the application torque exceeds the torque " $C_{NOMINAL}$ ", the motor can provide torque up to the value " $C_{MAX}$ " for the maximum duration " $t_{MAX}$ ". Thereafter, if the application torque is still higher than " $C_{NOMINAL}$ ", the motor torque is limited to the value " $C_{NOMINAL}$ " until the application torque falls back below this value.

 **WARNING**

**VOLTAGE SURGES**  
During the braking phases, the motor generates voltage surges.

- Check that its voltage surges can be tolerated by the other devices connected to the same power supply.
- Use an external circuit to limit voltage surges if the brake is being used intensively.

**Failure to comply with these precautions will result in death, serious injury or equipment damage.**

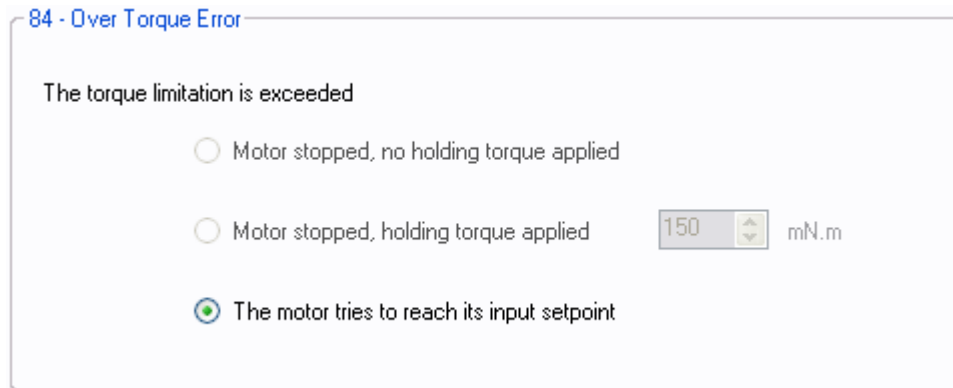
Setting the overvoltage detection threshold parameters: If the voltage at the motor terminals exceeds this threshold, an error is generated, the motor is stopped and no holding torque is applied (freewheeling).

Overvoltage Detection

Threshold voltage :  V

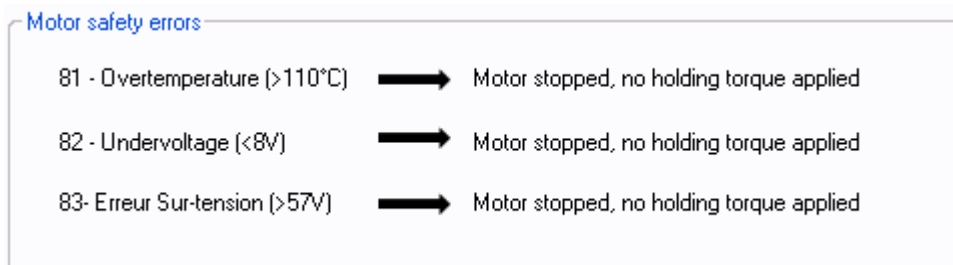
### 12.1.8.9. "Errors" Tab Parameters

Setting the parameters for the action to be taken when an overtorque error is encountered: real torque higher than the nominal torque " $C_{NOMINAL}$ " for a time longer than " $t_{MAX}$ ".



**Figure 140**

For all errors affecting motor safety, the action to be taken cannot be configured: in the event of an error, the motor is stopped and no holding torque is applied (freewheeling).



**Figure 141**

Procedure for restarting the motor following detection of an error:

- Eliminate the cause of the fault.
- Switch to stop mode: enable digital inputs 4 and 5.
- Switch back to run mode: disable either digital input 4 or digital input 5.

12.1.9. Expert Program V104

12.1.9.1. Description

Expert program V104 is used to:

- Create speed profiles with a choice of 8 preconfigured values.
- Set torque limiting with analog or PWM control.
- Set the acceleration/deceleration phase parameters via the HMI.

12.1.9.2. "Inputs" Tab Parameters

Combinations of digital inputs 1 to 3: Used to select the type of speed setpoint applied at the motor input: 8 possible combinations:

Inputs 1, 2, 3 - DIGITAL : Select speed setpoint

Input 1	Input 2	Input 3	Speed Setpoint (rpm)
0	0	0	0
1	0	0	500
0	1	0	1000
1	1	0	1500
0	0	1	2000
1	0	1	2500
0	1	1	3000
1	1	1	3500

Figure 142

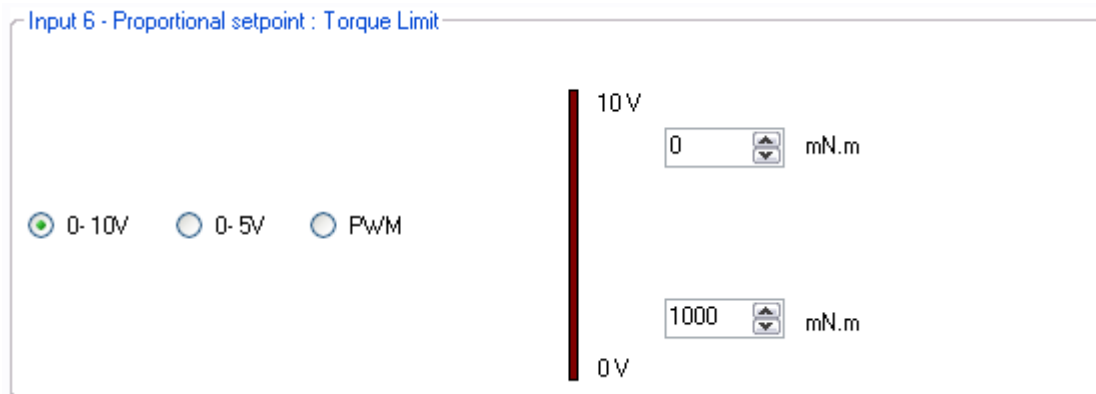
Combinations of digital inputs 4 and 5: Used to select the motion to be performed from the 4 actions indicated below.

Inputs 4, 5 - DIGITAL : Select motion

Input 4	Input 5	Motion
0	0	Fast stop
1	0	CCW direction
0	1	CW direction
1	1	Stop and remove error

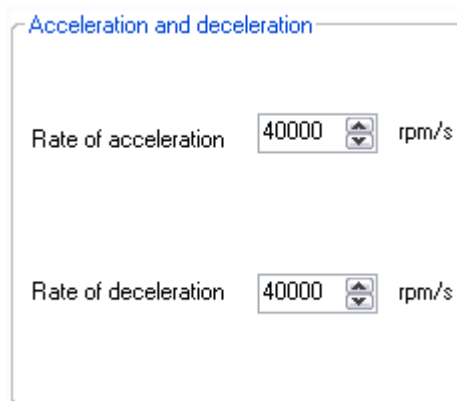
Figure 143

Setpoint input 6: Used to select the control type for the torque limiting setpoint and fix the maximum and minimum limits for this setpoint. An inverted scale can be used.



**Figure 144**

Setting the acceleration and braking ramps: These values are fixed via the HMI and cannot be changed by inputs while the motor is running. By default, the rates are fixed at 40,000 RPM/sec.



**Figure 145**

### 12.1.9.3. Type 1 "Outputs" Tab Parameters

Setting the parameters of Pulse output 1 "Real speed": A Hall pulse with configurable width (100 to 800  $\mu$ s) is generated each time one of the 3 motor Hall sensors changes state.

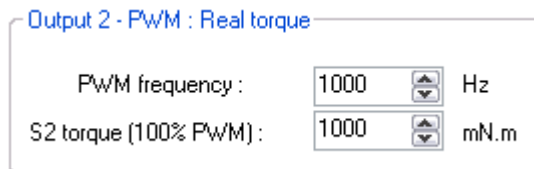
80140\_SMi21 and 80180\_SMi21 motors have 12 Hall pulses per revolution (2 pairs of poles).  
The 80280\_SMi21 motor has 24 Hall pulses per revolution (4 pairs of poles).



**Figure 146**

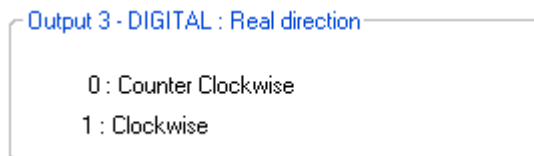
Setting the parameters of PWM output 2 "Real torque": The parameters can be set for the signal frequency of this output and the torque value corresponding to a cyclical ratio of 100% (scaling).

If cyclical ratio = 0% → Torque supplied = 0 mNm.  
If cyclical ratio = 100% → Torque supplied = "S2 torque".



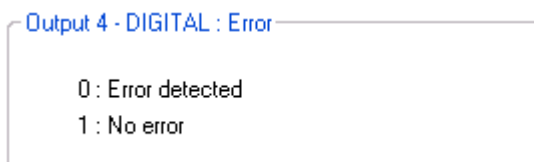
**Figure 147**

State of digital output 3 "Real direction": Used to find out the motor direction of rotation.



**Figure 148**

State of digital output 4 "Error": Used to find out whether an error has been detected.

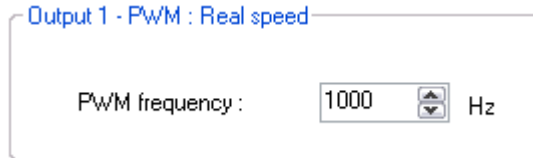


**Figure 149**

12.1.9.4. Type 2 "Outputs" Tab Parameters

Setting the parameters of PWM output 1 "Real speed": The parameters can be set for the signal frequency of this output (must be identical to the one for PWM output 2).

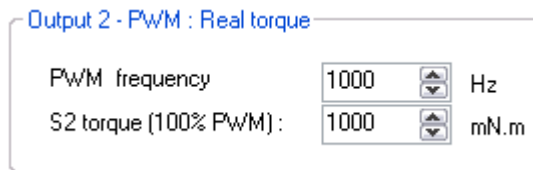
- If cyclical ratio = 0% → Real speed = 0 rpm.
- If cyclical ratio = 100% → Real speed = 4000 rpm.



**Figure 150**

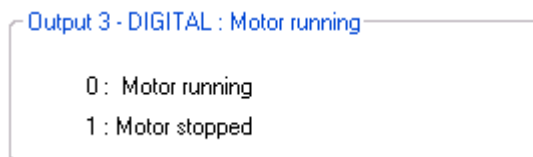
Setting the parameters of PWM output 2 "Real torque": The parameters can be set for the signal frequency of this output (must be identical to the one for PWM output 1) and the torque value corresponding to a cyclical ratio of 100% (scaling).

- If cyclical ratio = 0% → Torque supplied = 0 mNm.
- If cyclical ratio = 100% → Torque supplied = "S2 torque".



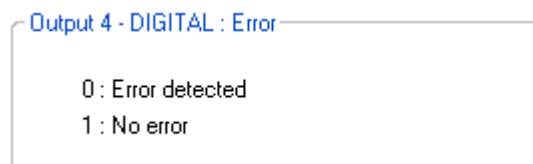
**Figure 151**

State of digital output 3 "Motor running": Used to find out whether the motor is stopped or running.



**Figure 152**

State of digital output 4 "Error": Used to find out whether an error has been detected.

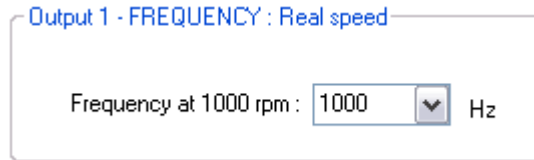


**Figure 153**



## 12.1.9.5. Type 3 "Outputs" Tab Parameters

Setting the parameters of frequency output 1 "Real speed": The parameters can be set for the signal frequency of this output for which the motor runs at 1000 RPM (200, 500 or 1000 Hz).

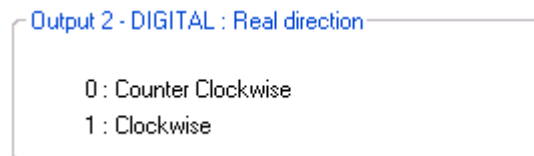


Output 1 - FREQUENCY : Real speed

Frequency at 1000 rpm : 1000 Hz

**Figure 154**

State of digital output 2 "Real direction": Used to find out the motor direction of rotation.

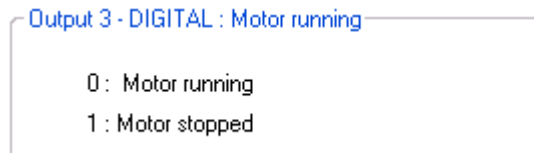


Output 2 - DIGITAL : Real direction

0 : Counter Clockwise  
1 : Clockwise

**Figure 155**

State of digital output 3 "Motor running": Used to find out whether the motor is stopped or running.

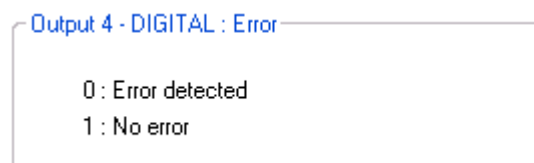


Output 3 - DIGITAL : Motor running

0 : Motor running  
1 : Motor stopped

**Figure 156**

State of digital output 4 "Error": Used to find out whether an error has been detected.



Output 4 - DIGITAL : Error

0 : Error detected  
1 : No error

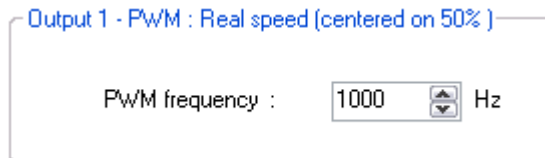
**Figure 157**



## 12.1.9.6. Type 4 "Outputs" Tab Parameters

Setting the parameters of PWM output 1: "Real speed (centered on 50%)": The parameters can be set for the signal frequency of this output (must be identical to the one for PWM output 2).

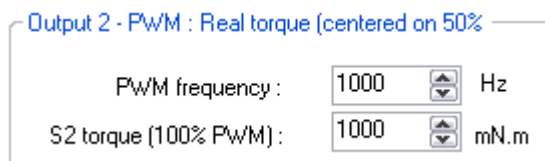
- If cyclical ratio = 0% → Motor running forward (CW) at speed of 4000 rpm.
- If cyclical ratio = 50% → Real speed = 0 rpm.
- If cyclical ratio = 100% → Motor running in reverse (CCW) at speed of 4000 rpm.



**Figure 158**

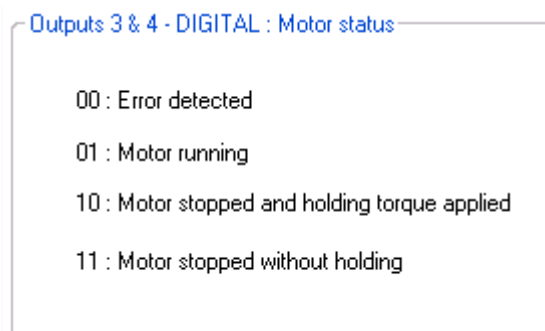
Setting the parameters of PWM output 2 "Real torque (centered on 50%)": The parameters can be set for the signal frequency of this output (must be identical to the one for PWM output 1) and the torque value corresponding to a cyclical ratio of 100% (scaling).

- If cyclical ratio = 0% → Braking torque supplied = "S2 torque".
- If cyclical ratio = 50% → Torque supplied = 0 mNm.
- If cyclical ratio = 100% → Motor torque supplied = "S2 torque".



**Figure 159**

Combinations of digital outputs 3 & 4 "Motor status": Used to find out the motor status.



**Figure 160**

12.1.9.7. "Tuning" Tab Parameters

Selection of the various parameters to be represented in graphic form: either 1, 2 or 3 parameters. The system speed response (measurement vs setpoint) can therefore be compared while displaying changes in the current.

- Speed setpoint
- Real speed
- Real torque

**Figure 161**

Set the PID controller factors in the speed control loop (this function is reserved for advanced users). The values given in the example below ensure correct product operation in the majority of cases.

Speed control loop parameters

K<sub>p</sub> =       K<sub>i</sub> =

K<sub>d</sub> =

**Figure 162**

It is possible to set the recording time you wish to view, from 1 to 300 seconds. The sampling interval is 10 ms. During data acquisition, the other HMI functions are not available.

Recording time :  Second(s)

**Figure 163**

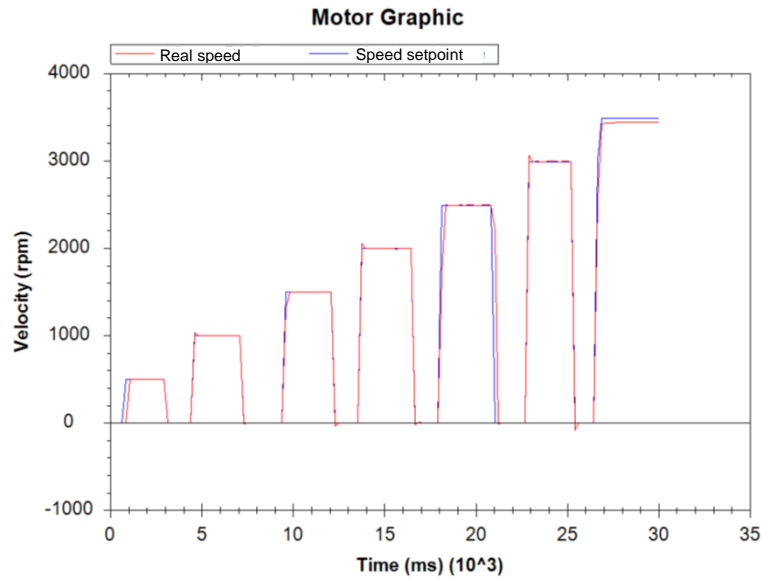
"Curve Drawing" button: used to start data acquisition. Curves are only displayed once acquisition is complete.

"Export Data" button: used to retrieve data corresponding to the selected parameters in a text file (.txt). To make this file compatible with the Excel spreadsheet, change its extension to .csv.

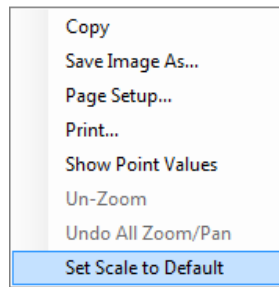
**Figure 164**

Example: With 8 preprogrammed speeds, this gives us the following graphic representation: (recording time of 30 seconds). Speed 1 is at 0 RPM.




**Figure 165**

Note: The display scales can be changed with the mouse wheel. Other functions are available by right-clicking the mouse.



**Figure 166**

12.1.9.8. "Limits" Tab Parameters

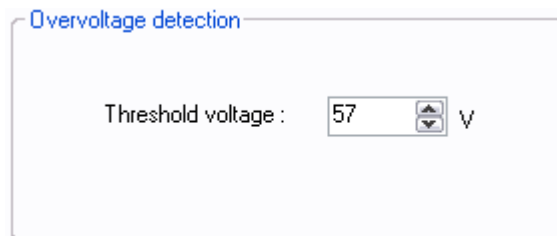
 **WARNING**

**VOLTAGE SURGES**  
 During the braking phases, the motor generates voltage surges.

- Check that its voltage surges can be tolerated by the other devices connected to the same power supply.
- Use an external circuit to limit voltage surges if the brake is being used intensively.

**Failure to comply with these precautions will result in death, serious injury or equipment damage.**

Setting the overvoltage detection threshold parameters: If the voltage at the motor terminals exceeds this threshold, an error is generated, the motor is stopped and no holding torque is applied (freewheeling).



**Figure 167**

12.1.9.9. "Errors" Tab Parameters

For all errors affecting motor safety, the action to be taken cannot be configured: in the event of an error, the motor is stopped and no holding torque is applied (freewheeling).

Motor safety errors		
81 - Overtemperature (>110°C)	➔	Motor stopped, no holding torque applied
82 - Undervoltage (<8V)	➔	Motor stopped, no holding torque applied
83 - Overvoltage(>57V)	➔	Motor stopped, no holding torque applied

**Figure 168**

Procedure for restarting the motor following detection of an error:

- Eliminate the cause of the fault.
- Switch to stop mode: enable digital inputs 4 and 5.
- Switch back to run mode: disable either digital input 4 or digital input 5.

12.1.10. Expert program V201

12.1.10.1. Description

V201 expert program allows to:

- Set a speed using an analog input 0/10V or 0/5V or PWM. The speed regulation is based on the “moving target” principle which allows to reach very low speed (down to 1 rpm).
- Or to set a relative position using the same analog input (0/10V or 0/5V or PWM).
- Switch between speed mode and position mode.

12.1.10.2. “Inputs” Tab Parameters

Digital input 1: « On/Off »

This input is to start or stop the motor. The input polarity is adjustable.



**Figure 169**

Digital input 2: « Mode »

This input is to select the speed or position mode. The input polarity is adjustable.

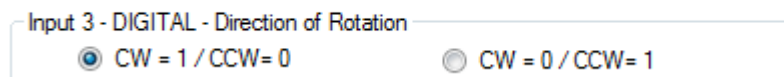


**Figure 170**

Digital input 3 (in speed mode): « Direction »

This input is to select motor direction. The input polarity is adjustable.

**Speed Mode :**



**Figure 171**

Digital input 3 (in position mode): « Go »

This input gives the start to go to a new position. This input is taken in count only after that the last positioning was completed.

The “Pulse time min.” works as a filter. The « Go » signal could not be taken in count if its duration is lower than the set value.

**Relative Position Mode :**



**Figure 172**

Digital inputs 4 and 5 (in speed mode) : « speed coding »

They allow to select the speed range for the IN6 input.

For each range, the min and max speed, the acceleration and deceleration can be set.

Input 4 . 5 - TOR : Speed Range Selection

E4	E5	Min (rpm)	Max (rpm)	Acceleration (rpm/s)	Deceleration (rpm/s)
0	0	1	1000	4000	4000
1	0	1000	2000	4000	4000
0	1	2000	3000	4000	4000
1	1	3000	3500	4000	4000

**Figure 173**

Digital inputs 4 and 5 (in position mode) : “Position coding”

They allow to select the relative position to reach (the step value to do).

For each of the positions, the number of pulses (4096 pulses → 1 motor turn), the max speed, the acceleration and deceleration can be set.

The last position is adjustable by IN6 analog input (IN4 = IN5 =0).

Input 4 . 5 - TOR : Position Selection

E4	E5	Pulses	Speed (rpm)	Acceleration (rpm/s)	Deceleration (rpm/s)
1	0	1000	1000	4000	4000
0	1	2000	1000	4000	4000
1	1	3000	1000	4000	4000
0	0	Input 6	1000	4000	4000

**Figure 174**

Analog input 6 (In speed mode) : « Speed »

This input adjusts motor speed using an analog 0/10V or 0/5V or PWM signal.

Speed range is given per IN4 + IN5 coding.

The setting parameter is:

- Analog signal type.

Input 6 - Proportional setpoint : Speed

0- 10V   
  0- 5V   
  PWM

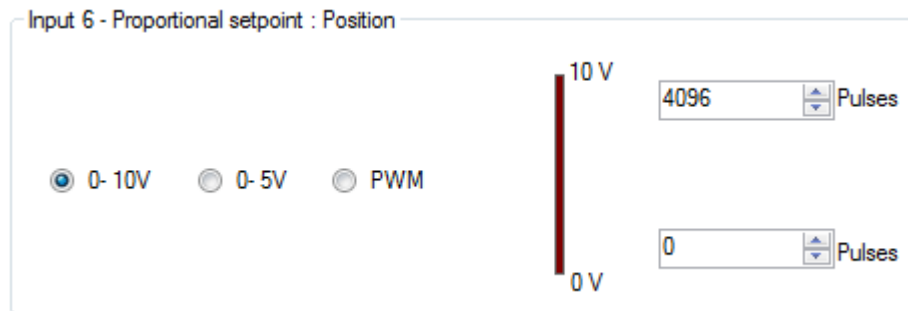
**Figure 175**

Analog input 6 (In position mode) : « Step »

This input adjusts the value of the step to do (relative position) when IN4=IN5=0, using an analog 0/10V or 0/5V or PWM signal.

The setting parameters are

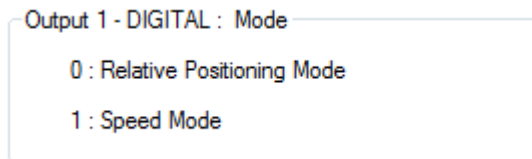
- Minimum of pulses (4096 pulses → 1 motor turn)
- Maximum of pulses (4096 pulses → 1 motor turn)
- Analog signal type.



**Figure 176**

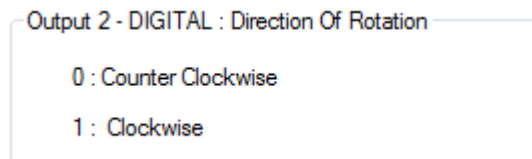
### 12.1.10.3. "Outputs" Tab Parameters

State of digital output 1: "Mode": Gives mode used.



**Figure 177**

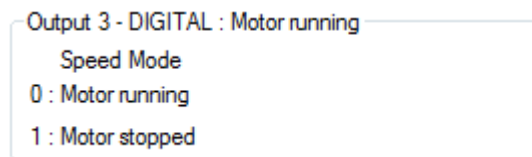
State of digital output 2: "Direction" Used to find out the motor direction of rotation.



**Figure 178**

State of digital output 3 (speed mode): "Motor running":

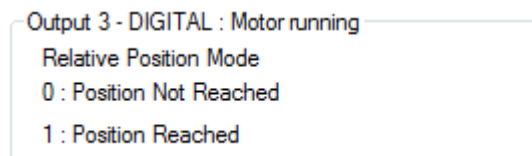
Used to find out whether the motor is stopped or running.



**Figure 179**

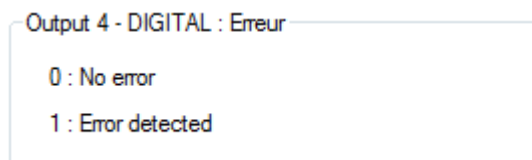
State of digital output 3 (position mode): "Target":

Used to find out if the position is reached.



**Figure 180**

State of digital output 4: "Error": Used to find out whether an error has been detected.



**Figure 181**



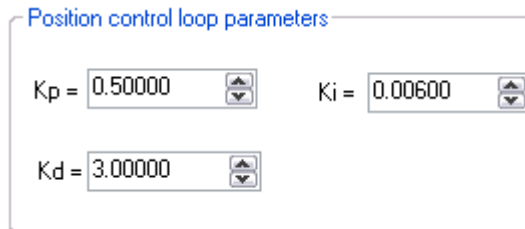
### 12.1.10.4. "Tuning" Tab Parameters

Selection of the various parameters to be represented in graphic form: either 1, 2, 3 or 4 parameters. The system position response (measurement vs setpoint) can therefore be compared while displaying changes in the current and the speed.

- Real Speed
- Real Torque
- Current Position
- Position setpoint

**Figure 182**

Set the PID controller factors in the position control loop (this function is reserved for advanced users). The values given in the example below ensure correct product operation in the majority of cases.



Position control loop parameters

K<sub>p</sub> = 0.50000      K<sub>i</sub> = 0.00600

K<sub>d</sub> = 3.00000

**Figure 183**

It is possible to set the recording time you wish to view, from 1 to 300 seconds. The sampling interval is 10 ms. During data acquisition, the other HMI functions are not available.

Recording time :  Second(s)



**Figure 184**

"Curve Drawing" button: used to start data acquisition. Curves are only displayed once acquisition is complete.

"Export Data" button: used to retrieve data corresponding to the selected parameters in a text file (.txt). To make this file compatible with the Excel spreadsheet, change its extension to .csv.

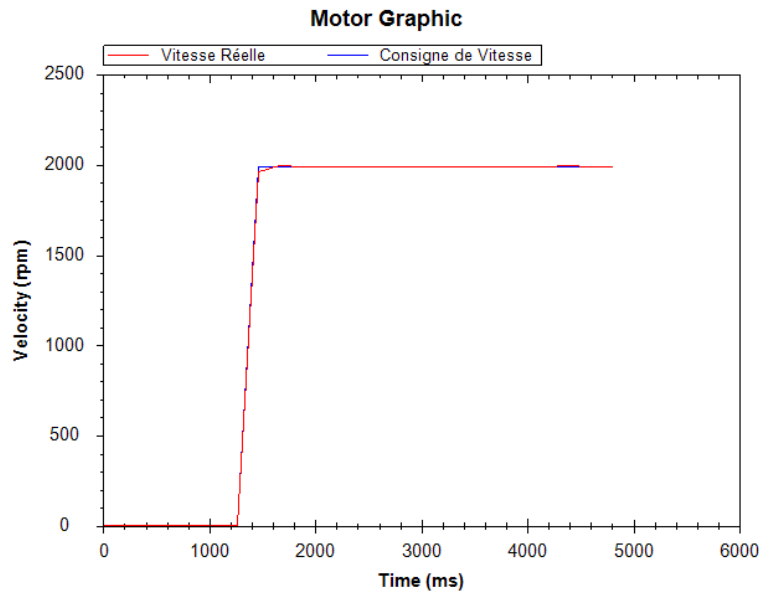


Curve Drawing      Export Data

**Figure 185**

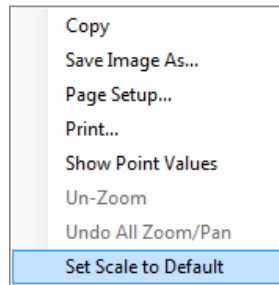


Example: With a speed setting at 2,000 rpm on IN6 and 5seconds measurement time, the following curves are obtained.




**Figure 186**

Note: The display scales can be changed with the mouse wheel. Other functions are available by right-clicking the mouse.

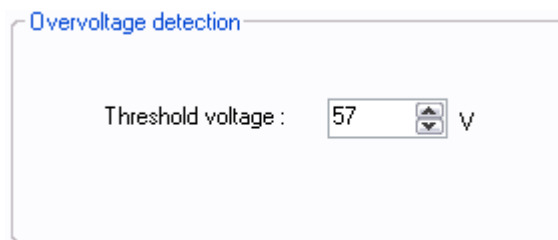


**Figure 187**

#### 12.1.10.5. "Limits" Tab Parameters

 <b>WARNING</b>
<p><b>VOLTAGE SURGES</b> During the braking phases, the motor generates voltage surges.</p> <ul style="list-style-type: none"> <li>• Check that its voltage surges can be tolerated by the other devices connected to the same power supply.</li> <li>• Use an external circuit to limit voltage surges if the brake is being used intensively.</li> </ul> <p><b>Failure to comply with these precautions will result in death, serious injury or equipment damage.</b></p>

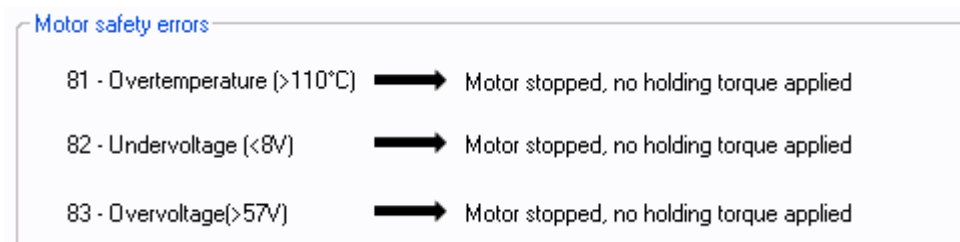
Setting the overvoltage detection threshold parameter: If the voltage at the motor terminals exceeds this threshold, an error is generated, the motor is stopped and no holding torque is applied (freewheeling).



**Figure 188**

### 12.1.10.6. "Errors" Tab Parameters

For all errors affecting motor safety, the action to be taken cannot be configured: in the event of an error, the motor stops, and no holding torque is applied (freewheeling).



**Figure 189**

### 12.1.11. Expert program V202

#### 12.1.11.1. Description

The expert program V202 allows to:

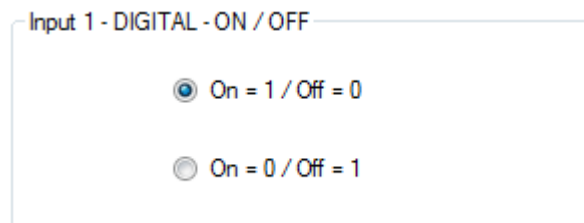
- To adjust a speed with an analog signal input 0/10V or 0/5V or PWM. The regulation is based on moving target principle and allows to reach very low speed values (down to 1rpm).
- To adjust a relative position using an analog input 0/10V or 0/5V or PWM.
- To switch from the speed mode (moving target) to the position mode (fix target) and reciprocally.

#### 12.1.11.2. "Inputs" Tab Parameters

##### Digital input 1: « On/OFF »

This input is to start or stop the motor.

The input polarity is adjustable.

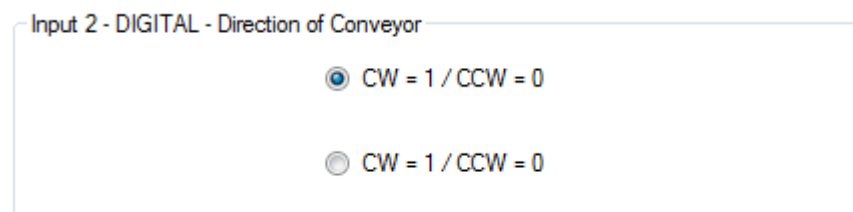


**Figure 190**

##### Digital input 2: « Direction »

This input reverses motor direction. This input doesn't inhibit IN4 (sensor input).

The input polarity is adjustable.

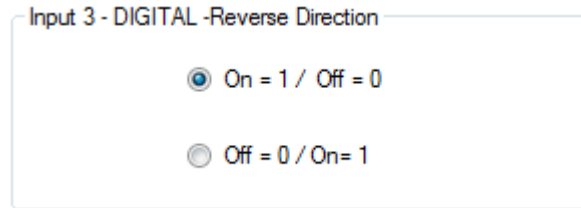


**Figure 191**

##### Digital input 3: « Reverse ».

This input reverses motor direction and inhibits IN4 (sensor input).

The input polarity is adjustable.



**Figure 192**

### Digital input 4 : « Sensor »

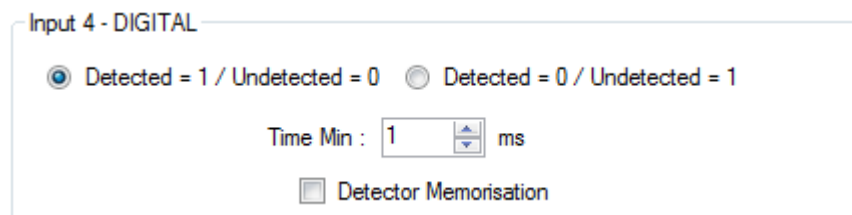
This input is to switch from the moving target position mode (speed mode) to the fix target position mode and reciprocally.

The input polarity is adjustable.

The parameter « minimum pulse duration » allows to filter IN4 “sensor” input signal. The signal has to exceed this time before to be taken in count.

Option PLC:

- If “Via PLC” is selected: motor switches to speed mode when “sensor” input IN4 is deactivated.
- If “Via PLC” is not selected: Motor memorizes the “sensor” input IN4 activations. To return to speed mode, an OFF/ON action on IN1 is required.



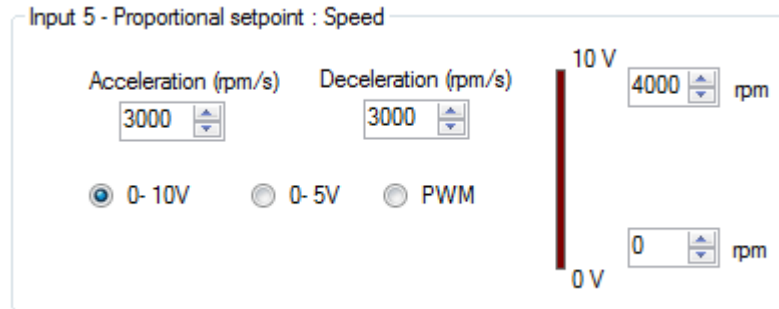
**Figure 193<sup>2</sup>**

### Analog input 5 : « Speed »

This input adjusts motor speed using an analog signal 0/10V or 0/5V or PWM.

The setting parameters are

- Speed range
- Acceleration (value for IN5 and IN6)
- Deceleration
- Analog signal type.



**Figure 194**

Analog input 6 : « Position »

This input adjusts the position set point using an analog signal 0/10V or 0/5V or PWM.

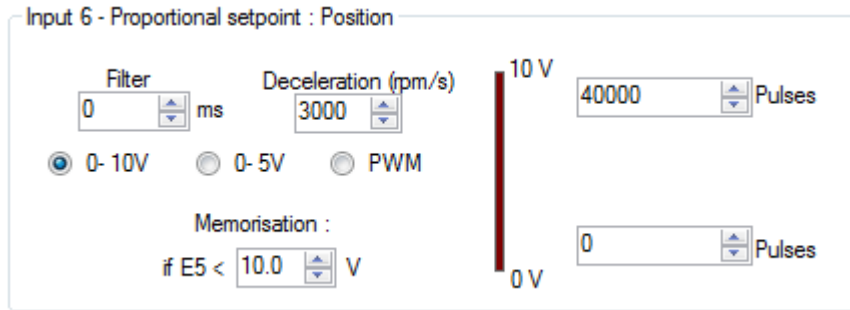
When IN4 is activated, motor memorizes its position and fixes it as the zero position reference.

The setting parameters are

- Position range (max:0 to 2,000,000,000 pulses = 0 to 488,000 motor turns)
- Deceleration
- Analog signal type.
- Filter time (IN6 signal has to be constant during a time exceeding this value before to be taken in count)
- Memorization (not available when IN6 is a PWM signal)

Take in count the IN6 signal changes when IN5 signal is lower than the set value.

- If value is 10V, IN6 changes are taken in count all the time
- If value is 0.2V, IN6 changes are taken in count only when IN5 setting is below this value. It can be used when analog signals are perturbed due to very long cabling and ground issues.



**Figure 195**

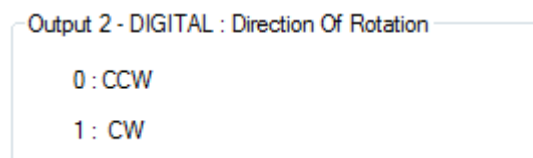
12.1.11.3. "Outputs" Tab Parameters

State of digital output 1 "Target Position Reached": Used to find out whether the position set point has been reached.



**Figure 196**

State of digital output 2 "Real direction": Used to find out the motor direction of rotation.



**Figure 197**

State of digital output 3 "Motor running": Used to find out whether the motor is stopped or running.



Output 3 - DIGITAL : Motor running

0 : Motor stopped

1 : Motor running

**Figure 198**

State of digital output 4 "Error": Used to find out whether an error has been detected.

Output 4 - DIGITAL : Erreur

0 : No error

1 : Error detected

**Figure 199**

12.1.11.4. "Tuning" Tab Parameters

Selection of the various parameters to be represented in graphic form: either 1, 2, 3 or 4 parameters. The system position response (measurement vs setpoint) can therefore be compared while displaying changes in the current and the speed.

- Real Speed
- Real Torque
- Current Position
- Position setpoint

**Figure 200**

Set the PID controller factors in the position control loop (this function is reserved for advanced users). The values given in the example below ensure correct product operation in the majority of cases.

Position control loop parameters

Kp = 0.50000      Ki = 0.00600

Kd = 3.00000

**Figure 201**

It is possible to set the recording time you wish to view, from 1 to 300 seconds. The sampling interval is 10 ms. During data acquisition, the other HMI functions are not available.

Recording time : 100 Second(s)

**Figure 202**

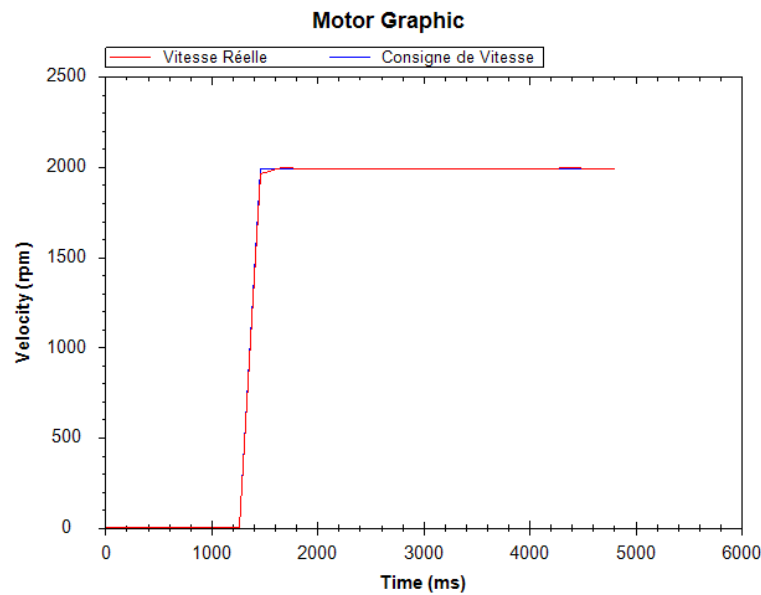
"Curve Drawing" button: used to start data acquisition. Curves are only displayed once acquisition is complete.

"Export Data" button: used to retrieve data corresponding to the selected parameters in a text file (.txt). To make this file compatible with the Excel spreadsheet, change its extension to .csv.

Curve Drawing      Export Data

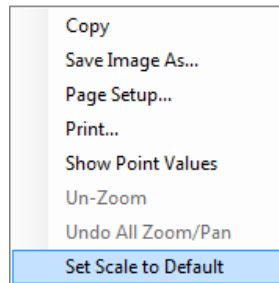
**Figure 203**

Example: With a speed setting at 2,000 rpm on IN5 and 5 seconds measurement time, the following curves are obtained.




**Figure 204**

Note: The display scales can be changed with the mouse wheel. Other functions are available by right-clicking the mouse.

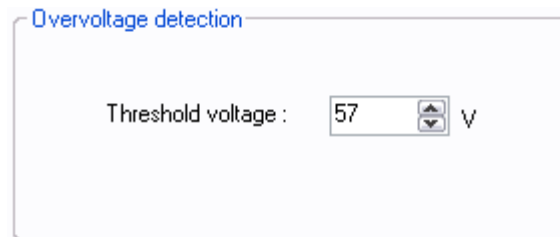


**Figure 205**

#### 12.1.11.5. "Limits" Tab Parameters

 <b>WARNING</b>
<p><b>VOLTAGE SURGES</b> During the braking phases, the motor generates voltage surges.</p> <ul style="list-style-type: none"> <li>• Check that its voltage surges can be tolerated by the other devices connected to the same power supply.</li> <li>• Use an external circuit to limit voltage surges if the brake is being used intensively.</li> </ul> <p><b>Failure to comply with these precautions will result in death, serious injury or equipment damage.</b></p>

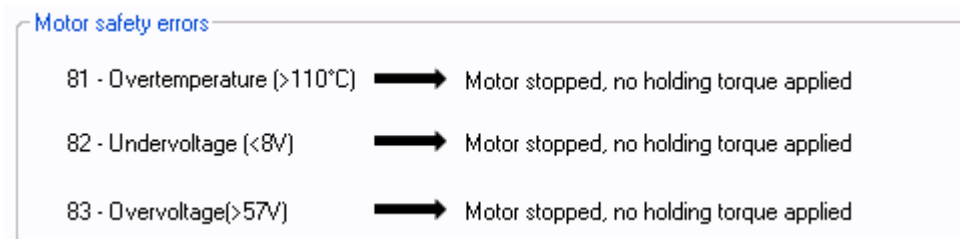
Setting the overvoltage detection threshold parameter: If the voltage at the motor terminals exceeds this threshold, an error is generated, the motor is stopped and no holding torque is applied (freewheeling).



**Figure 206**

### 12.1.11.6. "Errors" Tab Parameters

For all errors affecting motor safety, the action to be taken cannot be configured: in the event of an error, the motor stops, and no holding torque is applied (freewheeling).



Error Code	Description	Action
81	Overtemperature (>110°C)	Motor stopped, no holding torque applied
82	Undervoltage (<8V)	Motor stopped, no holding torque applied
83	Overvoltage(>57V)	Motor stopped, no holding torque applied

**Figure 207**

Procedure for restarting the motor following detection of an error:

- Eliminate the cause of the fault.
- Switch to stop mode: disable digital input 1 "On/Off".
- Switch back to run mode: enable digital input 1 "On/Off".

## 12.2. Position Programs



### 12.2.1. Types of Inputs in P100 Programs

The table below defines the function associated with each of the inputs in the 12 P100 programs (the color associated with the input number corresponds to that of the I/O bundle):

Inputs	Programs					
	P101	P102	P103	P104	P105	P106
In1	Position 1	Validation	Validation	Validation	Validation	Validation
In2	Position 2	1 to 8 positions	1 to 6 positions + Homing + ON/OFF	1 to 6 positions + Homing + ON/OFF	1 to 6 positions + Homing + ON/OFF	1 to 6 proportional positions + Homing + ON/OFF
In3	Position 3					
In4	Position 4					
In5	Homing	Homing	Speed ramps	Switch 1: limit stop	Switch 1: limit stop	Switch 1: limit stop
In6	ON/OFF	ON/OFF	Speed	Speed	Fast stop	Switch 2: limit stop

Inputs	P107	P108	P109	P110	P111	P112
In1	1 to 16 positions	Validation	Validation	Validation	1 to 30 positions + Homing + ON/OFF	1 to 30 proportional positions + Homing + ON/OFF
In2		1 to 14 positions + Homing + ON/OFF	1 to 14 positions + Homing + ON/OFF	1 to 14 positions + Homing + ON/OFF		
In3						
In4						
In5	Homing	Speed	Switch 1: limit stop	Fast stop	Switch 1: limit stop	Switch 1: limit stop
In6	ON/OFF					

Key:

	Digital type input
	Analog or PWM type input
	Forthcoming programs

## 12.2.2. Types of Inputs in P200 Programs

The table below defines the function associated with each of the inputs in the 5 P200 programs (the color associated with the input number corresponds to that of the I/O bundle):

Inputs	Programs		
	P201	P202	P203
<b>E1</b>	00 : Stop, erase error 10 : Homing	00 : Stop, erase error 10 : Homing	ON / OFF
<b>E2</b>	01 : Maintain actual position 11 : Live positioning	01 : Memorize new position setting 11 : Go to new memorized position	Homing
<b>E3</b>	Switch 1 : Limit stop	Switch 1 : Limit stop	Switch 1 : Limit stop
<b>E4</b>	Speed profile selection	Speed profile selection	Validation
<b>E5</b>	Position setting Coarse tuning	Position setting Coarse tuning	Analog max.speed setting
<b>E6</b>	Position setting Thin tuning	Position setting Thin tuning	Analog position setting (1024)

Inputs	Programs		
	P204	P205	P206
<b>E1</b>	ON / OFF	00 : Stop, erase error 10 : Homing	00 : Stop, erase error 10 : Homing
<b>E2</b>	Homing	01 : Memorize new position setting 11 : Go to new memorized position	01 : Maintain actual position 11 : Live positioning
<b>E3</b>	Switch 1 : Limit stop	Switch 1 : Limit stop	Switch 1 : Limit stop
<b>E4</b>	Switch 2 : Limit stop	Switch 2 : Limit stop	Switch 2 : Limit stop
<b>E5</b>	Validation	Analog max.speed setting	Analog max.speed setting
<b>E6</b>	Analog position setting (1024)	Analog position setting (1024)	Analog position setting (1024)

Key :

	Digital type input
	Analog or PWM type input
	Forthcoming programs

12.2.3. Types of Outputs in P100 and P200 Programs

For all expert position programs, 5 configurable output configurations are available (the color associated with the output number corresponds to that of the I/O bundle):

	Out1	Out2	Out3	Out4
Type 5	On stand-by, target reached (if 1) <i>Digital</i>	Homing phase complete (if 0) <i>Digital</i>	Motor running (if 1) <i>Digital</i>	Error (if 1) <i>Digital</i>
Type 6	On stand-by, target reached (if 1) <i>Digital</i>	Homing phase complete (if 1) <i>Digital</i>	Motor running (if 0) <i>Digital</i>	Error (if 0) <i>Digital</i>
Type 7	On stand-by, target reached (if 1) <i>Digital</i>	Real torque (centered on 50%) <i>PWM</i>	00 : error detected 01 : homing not performed <u>OR</u> not completed 10 : motor stopped <u>AND</u> homing completed 11 : motor running (positioning) <i>Digital combinations</i>	
Type 8	On stand-by, target reached (if 1) <i>Digital</i>	Real torque (centered on 50%) <i>PWM</i>	00 : error detected <u>OR</u> motor in stop mode <u>AND</u> homing not performed 01 : motor running (positioning) 10 : motor stopped <u>AND</u> homing completed 11 : not used <i>Digital combinations</i>	
Type 9	Hall pulse <i>pulse</i>	Direction of rotation <i>Digital</i>	00 : error detected <u>OR</u> motor in stop mode 01 : not used 10 : motor stopped <u>AND</u> target reached 11 : motor running (positioning) <i>Digital combinations</i>	

Key:

	Digital type output
	PWM/Pulse/Frequency type output

12.2.4. Description of the Different Types of Homing

The homing sequence is an initialization phase that helps the motor estimate the application total stroke by searching for mechanical stops. These stops can be detected in one of 2 ways:

- With 1 limit switch by retrieving information from one of the inputs.
- By detecting overtorque when the motor is at a mechanical stop.

N.B.: The default motor direction of rotation is forward (CW).

12.2.4.1. Homing Phase Without a Switch

a) Start from current position:

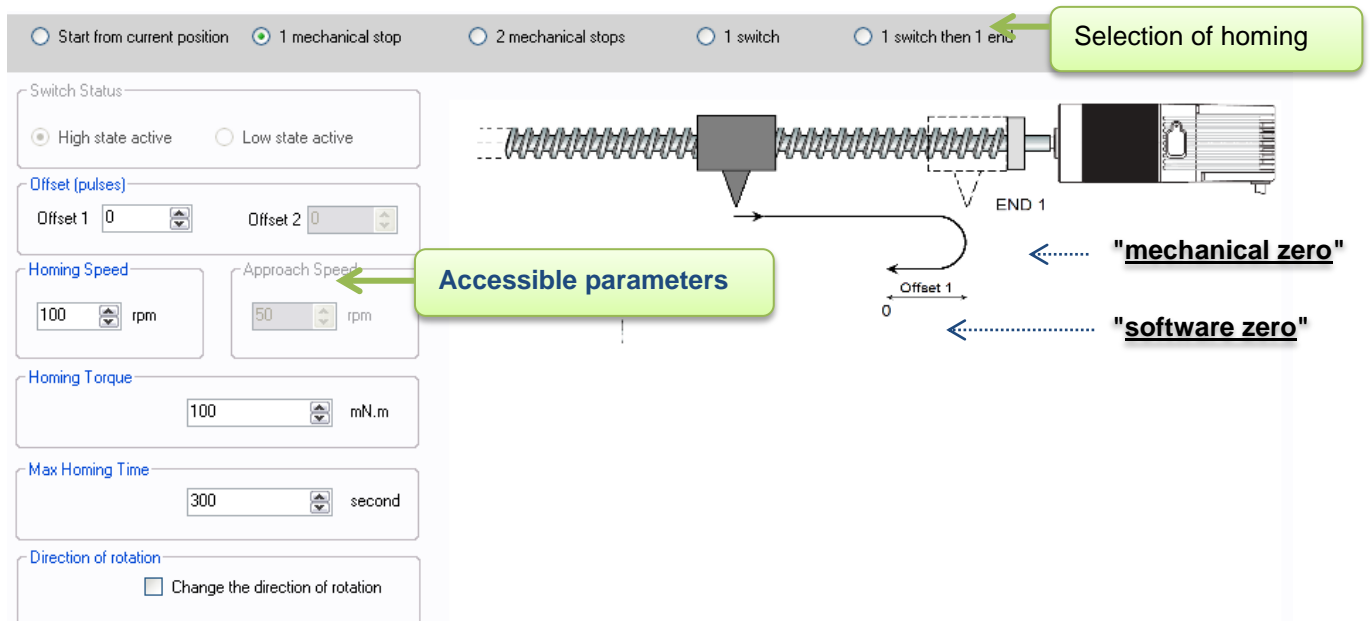
The screenshot shows a configuration window for homing. At the top, there are five radio buttons: 'Start from current position' (selected), '1 mechanical stop', '2 mechanical stops', '1 switch', and '1 switch then 1 end'. Below these are several parameter fields: 'Switch Status' (High/Low state active), 'Offset (pulses)' (Offset 1 and 2), 'Homing Speed' and 'Approach Speed' (rpm), 'Homing Torque' (mN.m), 'Max Homing Time' (second), and 'Direction of rotation' (checkbox for 'Change the direction of rotation'). A diagram of a motor shaft is shown with a reference point '0'. A callout box points to the 'Homing Torque' field with the text 'No parameter accessible for this type of homing'. Another callout box points to the '1 switch then 1 end' radio button with the text 'Selection of homing'.

**Figure 208**

When the homing sequence starts, the current position is used as a reference (position 0).



b) 1 mechanical stop:



**Figure 209**

This homing phase is used to search for the system mechanical stop as follows:

- Depending on the "END1" stop position (on the right or left), the user selects the appropriate "**Direction of rotation**" and sets a "**Homing Speed**".
- When the application torque increases to more than the "**Homing Torque**", the "END1" mechanical stop is detected, the motor is in the "**mechanical zero**" position.
- To avoid the motor coming into contact with the "END1" mechanical stop each time it returns to the reference position, "**Offset 1**" can be set (in encoder pulses).
- This new position should be considered as the reference position. The motor positions itself at "**software zero**": the homing phase is complete.
- As a safety measure, if the homing phase is not complete after the "**Max Homing Time**", the motor detects a "Homing" type error and stops.

c) 2 mechanical stops:

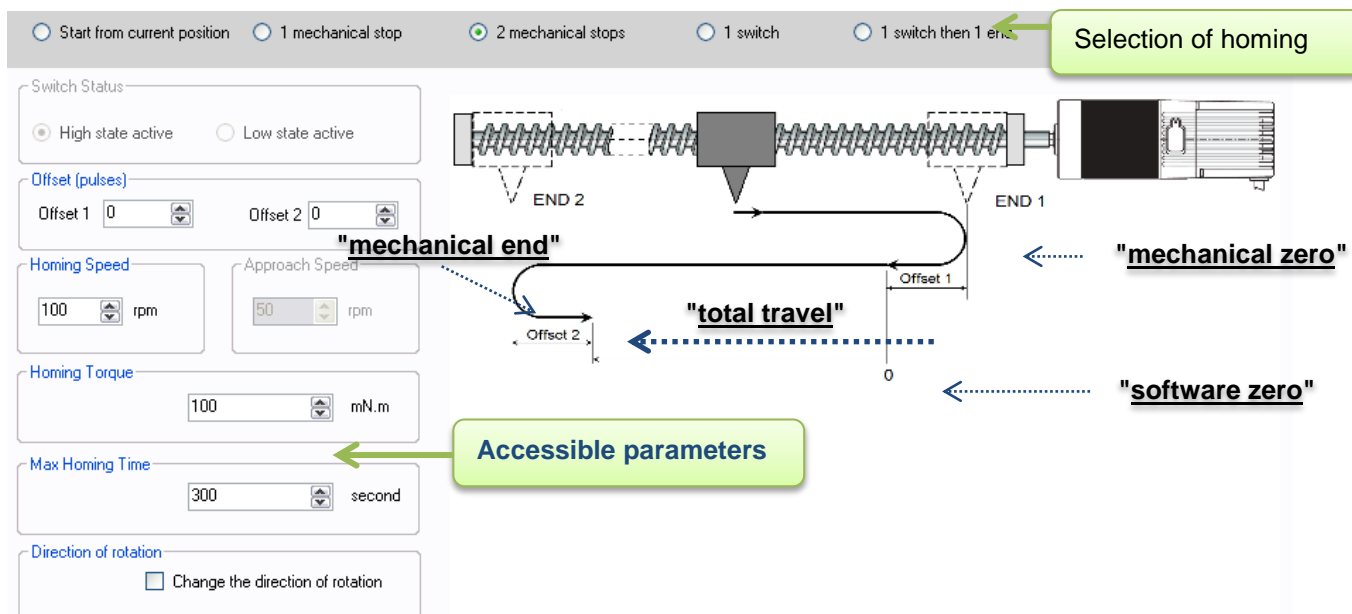


Figure 210

This homing phase is used to search for the 2 system mechanical stops as follows:

- Depending on the 1st "END1" stop position (on the right or left), the user selects the appropriate "**Direction of rotation**" and sets a "**Homing Speed**".
- When the application torque increases to more than the "**Homing Torque**", the "END1" mechanical stop is detected, the motor is in the "**mechanical zero**" position.
- To avoid the motor coming into contact with the "END1" mechanical stop each time it returns to the reference position, "**Offset 1**" can be set (in encoder pulses) which gives us the difference in position between the "**mechanical zero**" and the "**software zero**".
- The motor then travels in the opposite direction to find the 2nd mechanical stop "END2". The "END2" mechanical stop is detected in a similar way. The motor is in the "**mechanical end**" position.
- To avoid the motor coming into contact with the "END2" mechanical stop each time it returns to the reference position, "**Offset 2**" can be set (in encoder pulses) which gives us the difference in position between the "**mechanical end**" and the "**total stroke**".
- After detecting both mechanical stops, the motor positions itself at (END2 – offset 2): the homing phase is complete.
- As a safety measure, if the homing phase is not complete after the "**Max Homing Time**", the motor detects a "Homing" type error and stops.

12.2.4.2. Homing Phase With 1 Switch

a) 1 switch:

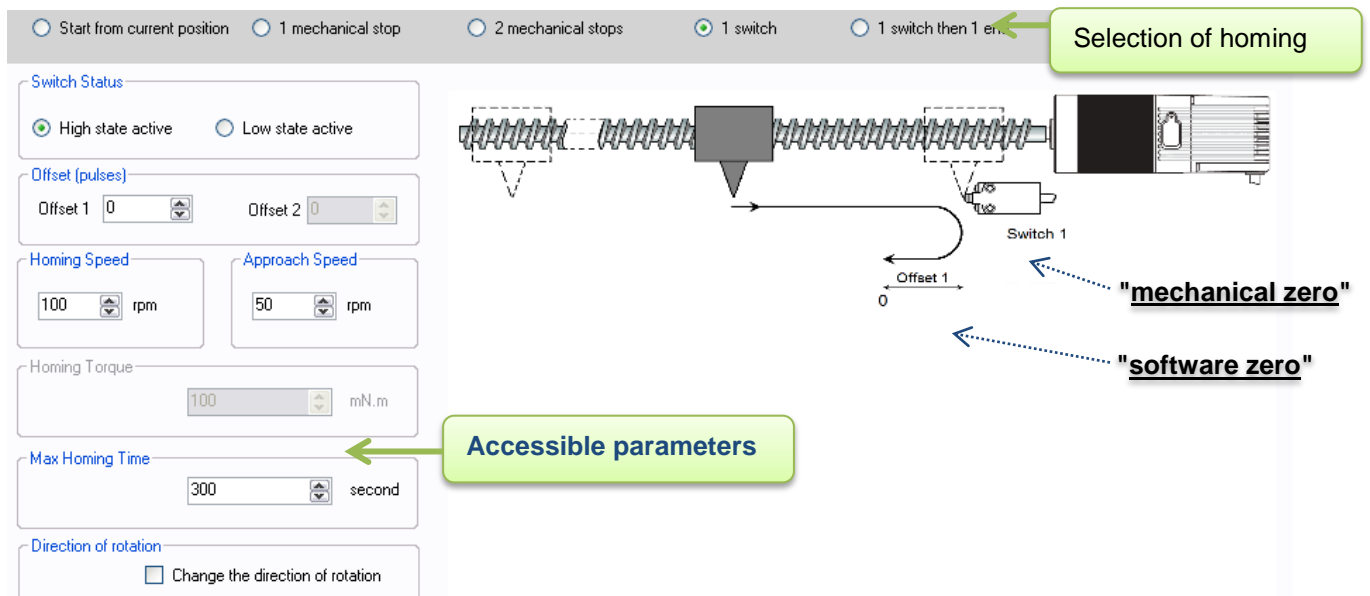


Figure 211

This homing phase is used to search for the system "switch" type stop as follows:

- First configure the switch polarity: « **High state active** " or "**Low state active** ".
- Depending on the switch position (on the right or left), the user selects the appropriate "**Direction of rotation**" and sets a "**Homing Speed**".
- When the switch changes state, the "Switch 1" stop is detected. The motor is in the "**mechanical zero**" position.
- To avoid the motor coming into contact with the switch each time it returns to the reference position, "**Offset 1**" can be set (in encoder pulses).
- This new position should be considered as the reference position. The motor positions itself at "**software zero**": the homing phase is complete.
- As a safety measure, if the homing phase is not complete after the "**Max Homing Time**", the motor detects a "Homing" type error and stops.

b) 1 switch then 1 end: with the zero defined by the switch

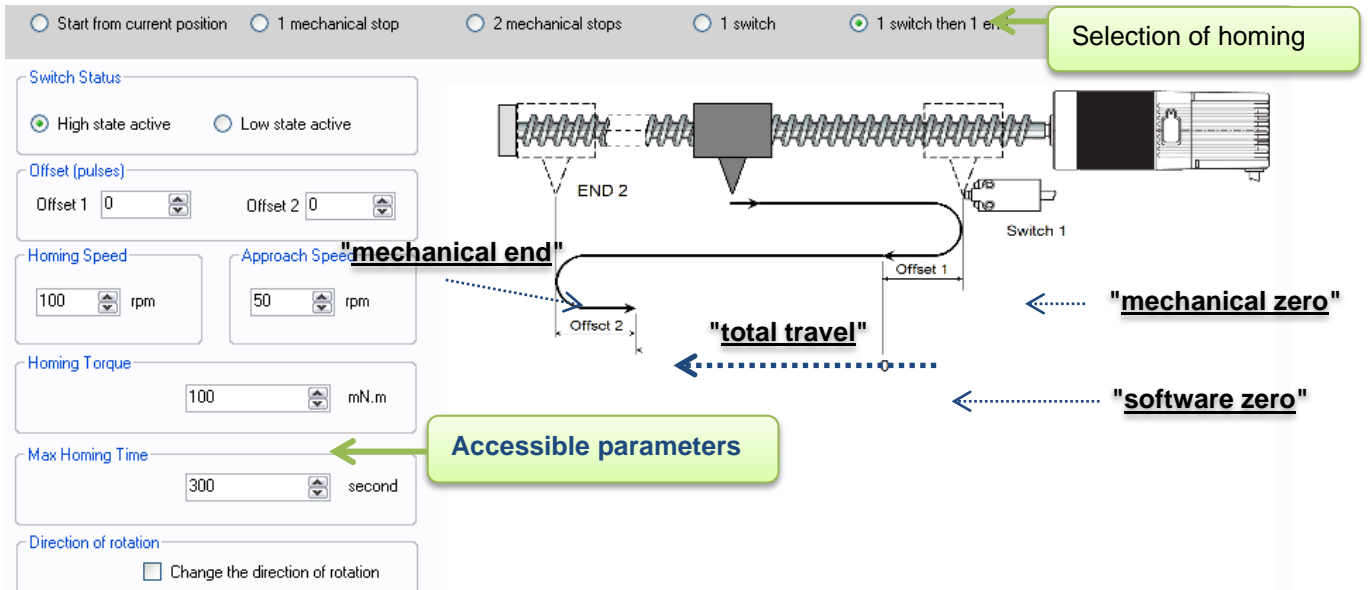


Figure 212

This homing phase is used to search initially for the system "switch" type stop, then for the system mechanical stop as follows:

- First configure the switch polarity: « **High state active** " or "**Low state active** ".
- Depending on the switch position (on the right or left), the user selects the appropriate "**Direction of rotation**" and sets a "**Homing Speed**".
- When the switch changes state, the first stop "Switch 1" is detected. The motor is in the "**mechanical zero**" position.
- To avoid the motor coming into contact with the "Switch 1" stop each time it returns to the reference position, "**Offset 1**" can be set (in encoder pulses) which gives us the difference in position between the "**mechanical zero**" and the "**software zero**".
- The motor then travels in the opposite direction to find the 2nd mechanical stop "END2".
- When the application torque increases to more than the "**Homing Torque**", the "END2" mechanical stop is detected, the motor is in the "**mechanical zero**" position.
- To avoid the motor coming into contact with the "END2" mechanical stop each time it returns to the reference position, "**Offset 2**" can be set (in encoder pulses) which gives us the difference in position between the "**mechanical end**" and the "**total stroke**".
- After detecting both stops, the motor positions itself at (END2 – offset 2): the homing phase is complete.
- As a safety measure, if the homing phase is not complete after the "**Max Homing Time**", the motor detects a "Homing" type error and stops.

c) 1 end then 1 switch: with the zero defined by the mechanical switch

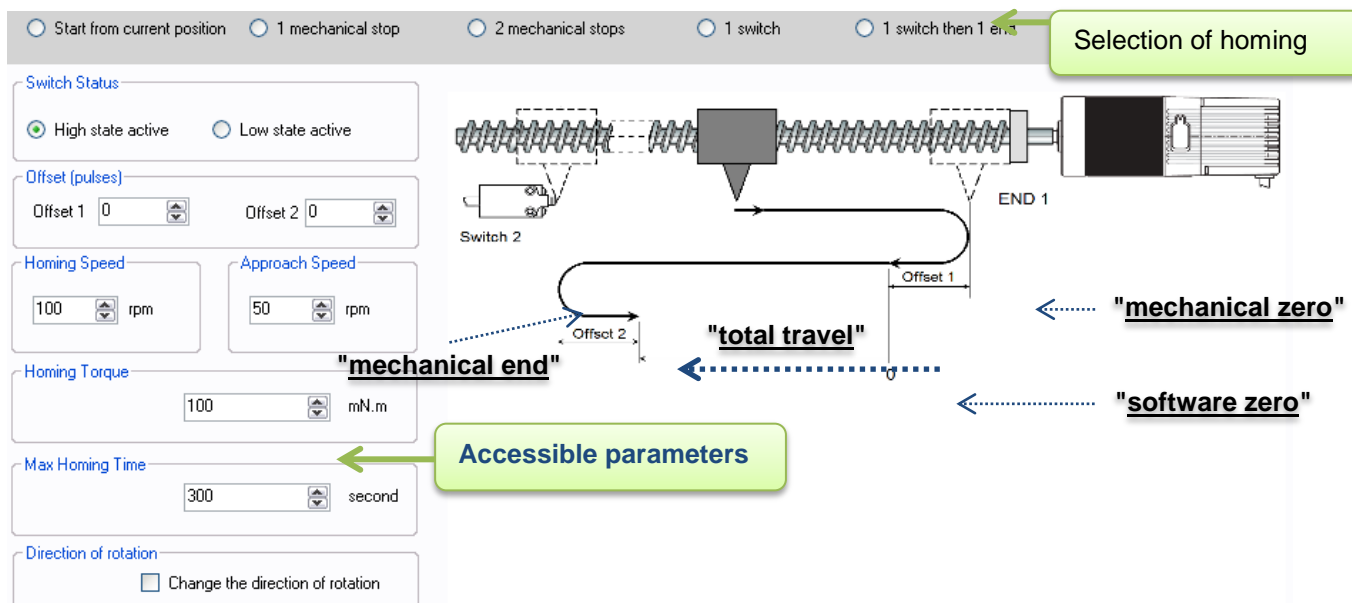


Figure 213

This homing phase is used to search initially for the system mechanical stop, then for the system "switch" type stop as follows:

- First configure the switch polarity: « **High state active** " or "**Low state active** ".
- Depending on the "END1" stop position (on the right or left), the user selects the appropriate "**Direction of rotation**» and sets a "**Homing Speed**".
- When the application torque increases to more than the "**Homing Torque**", the "END1" mechanical stop is detected, the motor is in the "**mechanical zero**" position.
- To avoid the motor coming into contact with the "END1" mechanical stop each time it returns to the reference position, "**Offset 1**" can be set (in encoder pulses) which gives us the difference in position between the "**mechanical zero**" and the "**software zero**".
- The motor then travels in the opposite direction to find the 2nd stop "Switch 2".
- When the switch changes state, the 2nd stop "Switch 2" is detected, the motor is in the "**mechanical end**" position.
- To avoid the motor coming into contact with the "Switch 2" stop each time it returns to the reference position, "**Offset 2**" can be set (in encoder pulses) which gives us the difference in position between the "**mechanical end**" and the "**total stroke**".
- After detecting both stops, the motor positions itself at (Switch 2 – offset 2): the homing phase is complete.
- As a safety measure, if the homing phase is not complete after the "**Max Homing Time**", the motor detects a "Homing" type error and stops.

12.2.5. Description of the P100 Various Tabs

For the description of tabs, expert program P101 is used as an example (for detailed information about each position expert program, see the "Expert Program P101" to "Expert Program P111" sections in this document).

12.2.5.1. Home Page

This page is common to all the expert and application programs, whether in speed, position or torque mode. It can be used to choose between the various types of application and expert programs.

In our example, we have chosen the "Position P100" category in the "Expert Programs" group, so the icons for the various P100 expert programs appear in the bottom right-hand corner of the window, and you then need to click on the one corresponding to the "P101" expert program:

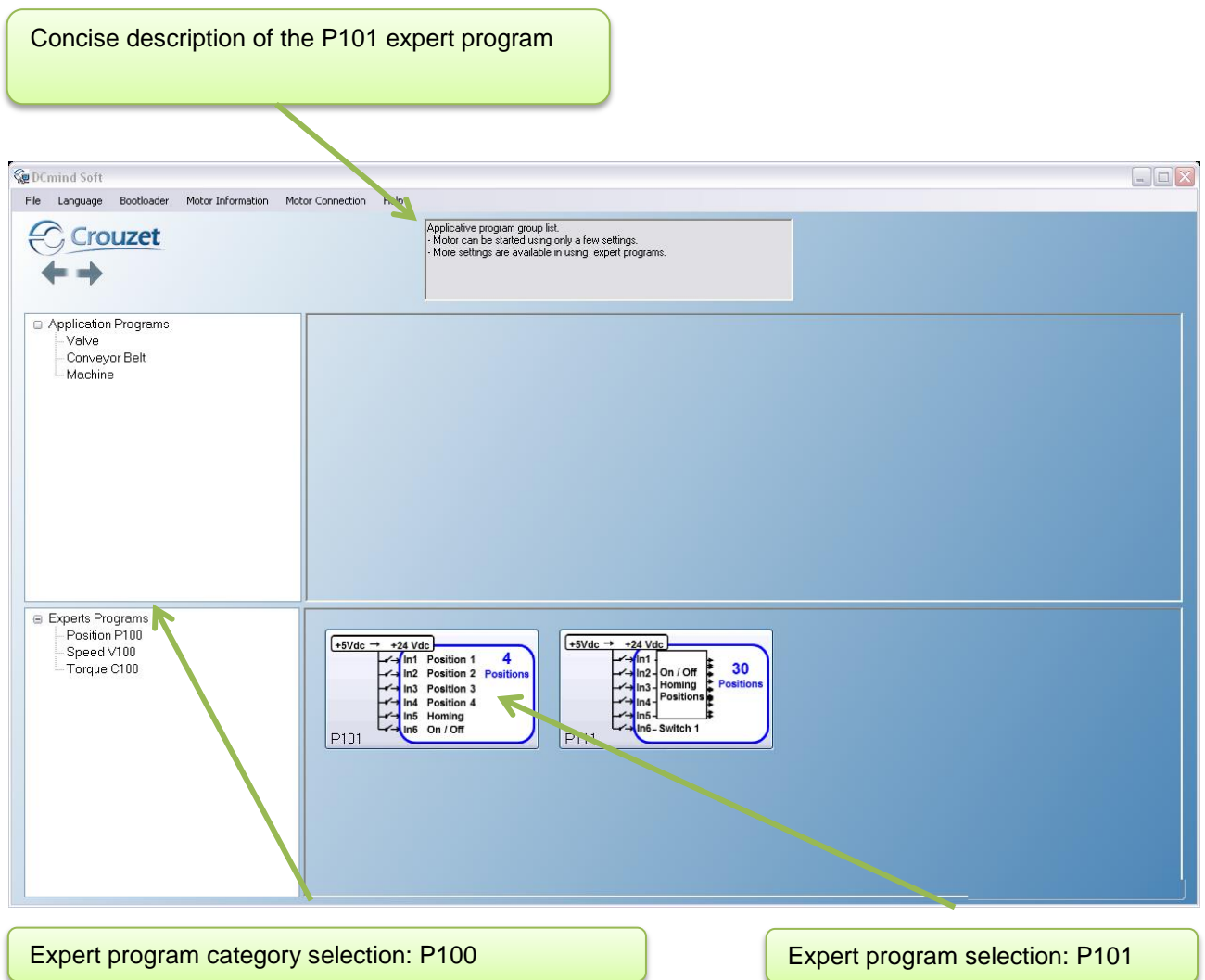


Figure 214

12.2.5.2. "Description" Tab

This is an information tab containing a concise description of the various position profiles that are created using this expert mode:

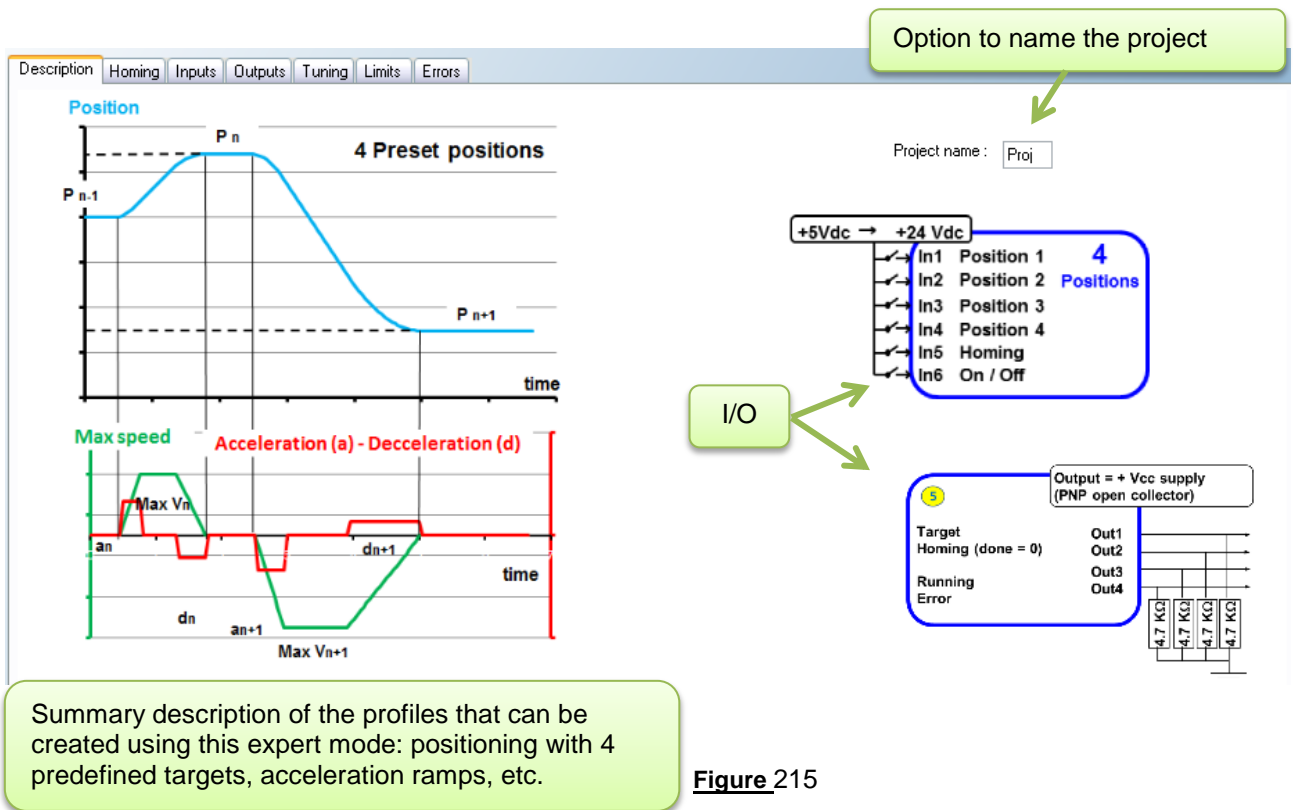


Figure 215

### 12.2.5.3. "Homing" Tab

This tab is used to select and configure the type of homing to be performed: offset(s), speed, homing torque, maximum duration of the homing phase, motor direction of rotation to search for the 1st stop.

**Selection of the type of homing to be performed: 0, 1 or 2 mechanical**

**Parameters associated with the selected homing**

**Summary description of the selected homing phase**

### 12.2.5.4. "Inputs" Tab

This tab is used to configure the various inputs in this expert mode (digital input polarity, setting the parameters for the 4 target positions: position, maximum speed, acceleration and deceleration rates).

Position	Position (pulses)	Speed (rpm)	Acceleration (rpm/s)	Deceleration (rpm/s)
E1	1000	1000	40000	40000
E2	2000	1000	40000	40000
E3	3000	1000	40000	40000
E4	4000	1000	40000	40000

**Figure 217**



12.2.5.5. "Outputs" Tab

This tab is used to select and configure the various outputs in this expert mode (position type 5 to type 9):

The screenshot shows the 'Outputs' configuration interface for a brushless motor. At the top, there are tabs for 'Description', 'Homing', 'Inputs', 'Outputs', 'Tuning', 'Limits', and 'Errors'. Below the tabs, a row of radio buttons allows selecting the motor type, with 'Type 5' currently selected. The main area contains a grid of 20 output configuration boxes, each with a title and a list of digital states (0 and 1) and their meanings. Below this grid, five green callout boxes with upward-pointing arrows identify specific configurations: 'Output 5 type parameter settings' points to the 'Output 4 - DIGITAL : Error' box; 'Output 6 type parameter settings' points to the 'Output 4 - DIGITAL : Error' box; 'Output 7 type parameter settings' points to the 'Output 4 - DIGITAL : Error' box; 'Output 8 type parameter settings' points to the 'Outputs 3 & 4 - DIGITAL : Motor status' box; and 'Output 9 type parameter settings' points to the 'Output 4 - DIGITAL : Error' box.

**Figure 218**

### 12.2.5.6. "Tuning" Tab

This tab is used to represent some parameters (speed, position, torque, etc.) in graphic form and modify the position control loop coefficients. It is common to all the position expert programs.

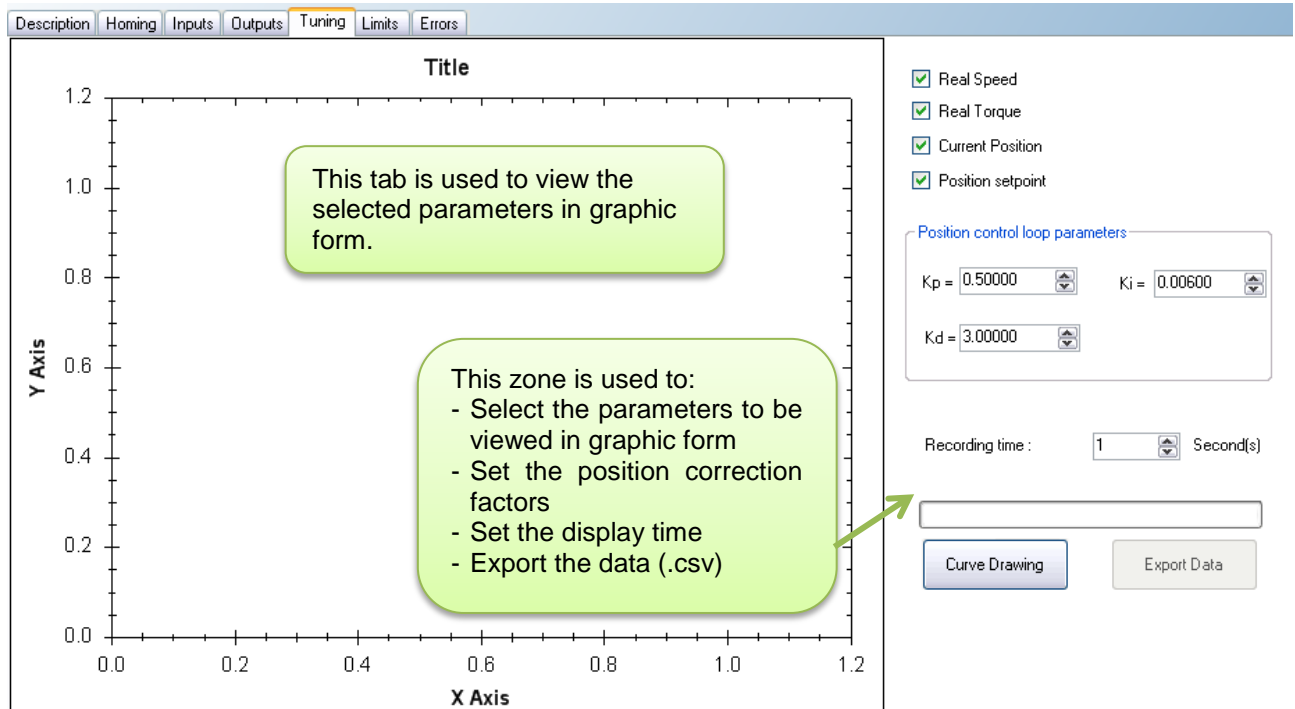


Figure 219

### 12.2.5.7. "Limits" Tab

This tab is used to configure the various motor operating limits: nominal and maximum torque (torque peak authorization) and the power supply overvoltage threshold.

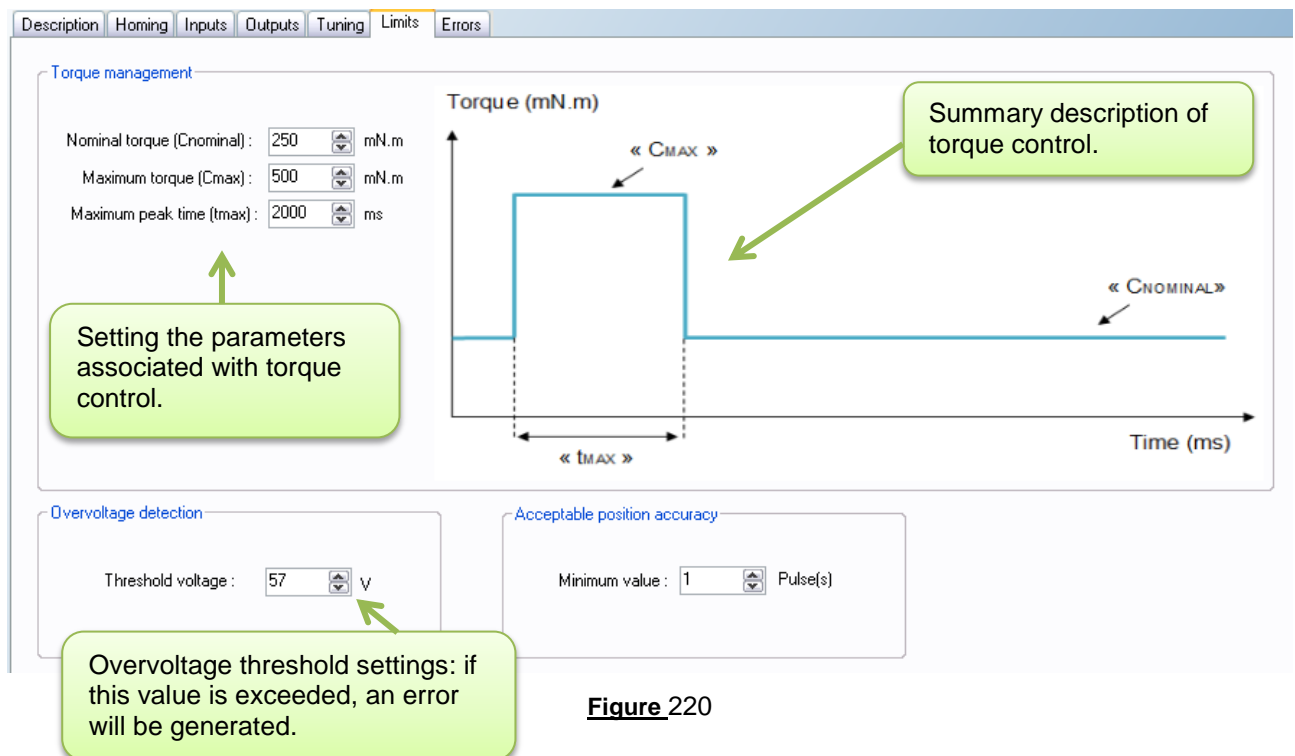
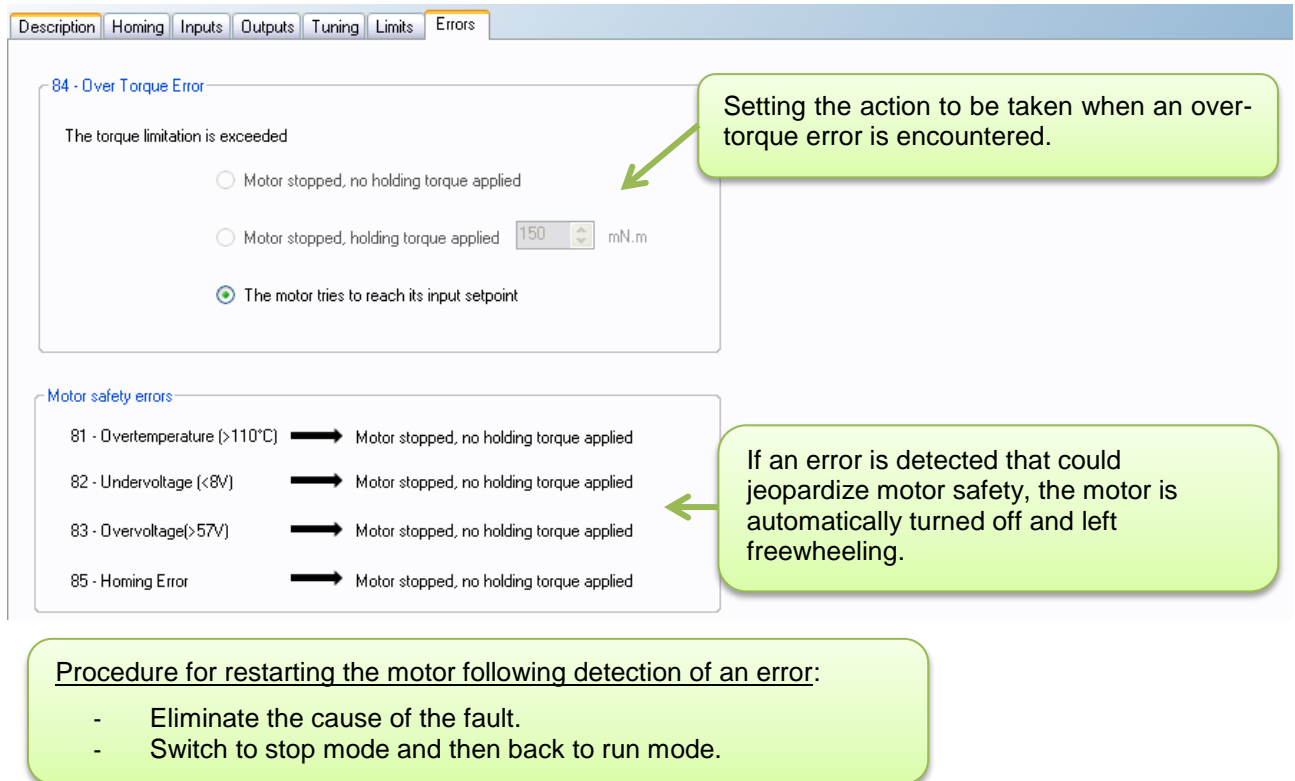


Figure 220

### 12.2.5.8. "Errors" Tab

This tab provides information about the type of error encountered (based on the error code) and the action to be taken by the motor following this error.

Action for the over-torque error can be configured.



**84 - Over Torque Error**

The torque limitation is exceeded

- Motor stopped, no holding torque applied
- Motor stopped, holding torque applied  mN.m
- The motor tries to reach its input setpoint

**Motor safety errors**

81 - Overtemperature (>110°C)	➔	Motor stopped, no holding torque applied
82 - Undervoltage (<8V)	➔	Motor stopped, no holding torque applied
83 - Overvoltage(>57V)	➔	Motor stopped, no holding torque applied
85 - Homing Error	➔	Motor stopped, no holding torque applied

**Setting the action to be taken when an over-torque error is encountered.**

**If an error is detected that could jeopardize motor safety, the motor is automatically turned off and left freewheeling.**

**Procedure for restarting the motor following detection of an error:**

- Eliminate the cause of the fault.
- Switch to stop mode and then back to run mode.

**Figure 221**

12.2.6. Expert Program P101

12.2.6.1. Description

Expert program P101 is used to:

- Perform a homing phase to initialize the system with detection of the stroke ends.
- Perform various positionings using 4 preset setpoint positions, each corresponding to one of the digital inputs "In1" to "In4".
- Set the acceleration/deceleration phases and the maximum speed that must not be exceeded between each point via the HMI.

12.2.6.2. "Homing" Tab Parameters

Set the difference in position (in pulses) between the mechanical stops and the application total stroke limits: stop 1 (END1) represents the stroke start, stop 2 (END2) represents the stroke end.

Note: Where there is only one mechanical stop, the "Offset 2" parameter is not available.



**Figure 222**

Set the search speed for stops during the homing phase.



**Figure 223**

Set the homing torque that allows the mechanical stop to be found by detection of overtorque.



**Figure 224**

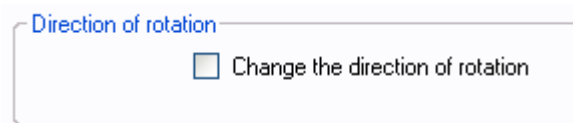
Set the maximum permitted time for the homing phase. If this value is exceeded, an error will be generated. Time limited to 300 seconds.



**Figure 225**

Set the direction of rotation for the first stop search (END1).

N.B.: By default, the motor runs forward (CW).



**Figure 226**

### 12.2.6.3. "Inputs" Tab Parameters

Digital input 1: Used to set the "Position 1" input polarity.



Input 1 - DIGITAL - Position 1

High state active

Low state active

**Figure 227**

Digital input 2: Used to set the "Position 2" input polarity.



Input 2 - DIGITAL - Position 2

High state active

Low state active

**Figure 228**

Digital input 3: Used to set the "Position 3" input polarity.



Input 3 - DIGITAL - Position 3

High state active

Low state active

**Figure 229**

Digital input 4: Used to set the "Position 4" input polarity.



Input 4 - DIGITAL - Position 4

High state active

Low state active

**Figure 230**

Set the 4 position setpoints and the speed profiles to be followed (acceleration ramp, speed step and deceleration ramp: trapezoidal profile):

Inputs 1, 2, 3, 4 - DIGITAL : Select Position Setpoint

	Position(pulses)	Speed (rpm)	Acceleration (rpm/s)	Deceleration (rpm/s)
E1	1000	1000	40000	40000
E2	2000	1000	40000	40000
E3	3000	1000	40000	40000
E4	4000	1000	40000	40000

**Figure 231**

Digital input 5: Used to set the "Start Homing" input polarity.

Input 5 - DIGITAL - Start Homing

Start Homing=1 / Stop Homing=0

Start Homing=0 / Stop Homing=1

**Figure 232**

Digital input 6: Used to set the "On/Off" input polarity.

Input 6 - DIGITAL : ON / OFF

ON=1 / OFF=0

ON=0 / OFF=1

**Figure 233**

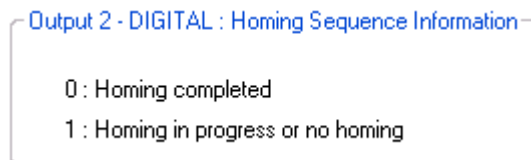
#### 12.2.6.4. Type 5 "Outputs" Tab Parameters

State of digital output 1 "Target Reached Flag": Used to find out whether the position setpoint has been reached.



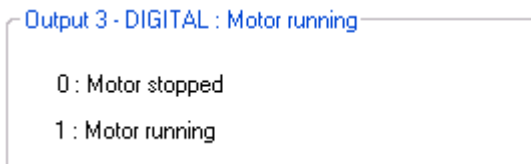
**Figure 234**

State of digital output 2 "Homing Sequence Information": Used to find out how the homing phase is progressing: completed, in progress or not performed.



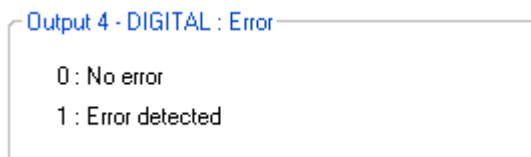
**Figure 235**

State of digital output 3 "Motor running": Used to find out whether the motor is stopped or running.



**Figure 236**

State of digital output 4 "Error": Used to find out whether an error has been detected.



**Figure 237**



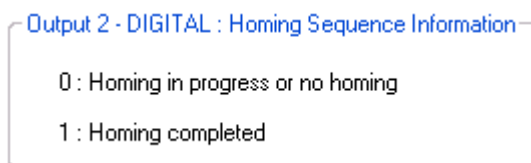
### 12.2.6.5. Type 6 "Outputs" Tab Parameters

State of digital output 1 "Target Reached Flag": Used to find out whether the position setpoint has been reached.



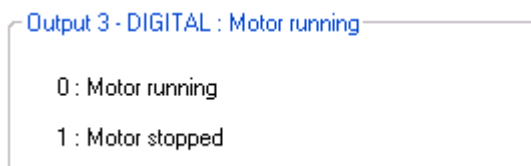
**Figure 238**

State of digital output 2 "Homing Sequence Information": Used to find out how the homing phase is progressing: completed, in progress or not performed.



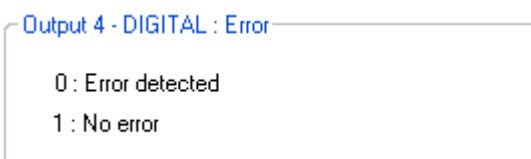
**Figure 239**

State of digital output 3 "Motor running": Used to find out whether the motor is stopped or running.



**Figure 240**

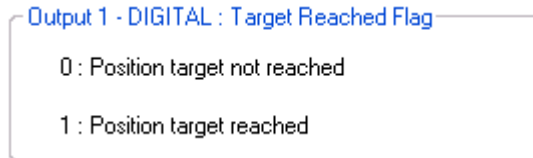
State of digital output 4 "Error": Used to find out whether an error has been detected.



**Figure 241**

12.2.6.6. Type 7 "Outputs" Tab Parameters

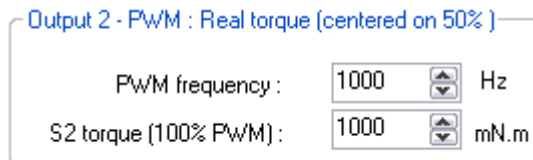
State of digital output 1 "Target Reached Flag": Used to find out whether the position setpoint has been reached.



**Figure 242**

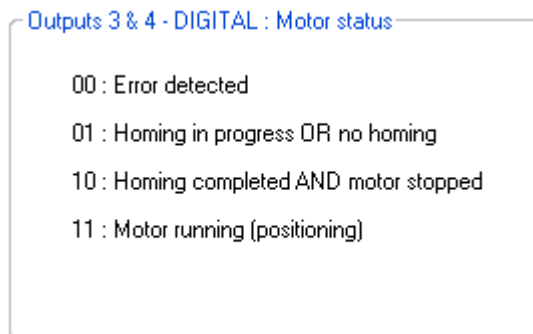
Setting the parameters of PWM output 2 "Real torque (centered on 50%)": The parameters can be set for the signal frequency of this output and the torque value corresponding to a cyclical ratio of 100% (scaling).

- If cyclical ratio = 0% → Braking torque supplied = "S2 torque".
- If cyclical ratio = 50% → Torque supplied = 0 mNm.
- If cyclical ratio = 100% → Motor torque supplied = "S2 torque".



**Figure 243**

Combinations of digital outputs 3 & 4 "Motor status": Used to find out the motor status.



**Figure 244**

### 12.2.6.7. Type 8 "Outputs" Tab Parameters

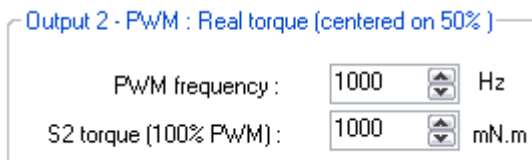
State of digital output 1 "Target Reached Flag": Used to find out whether the position setpoint has been reached.



**Figure 245**

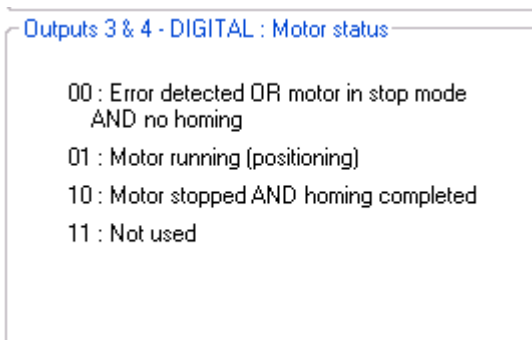
Setting the parameters of PWM output 2 "Real torque (centered on 50%)": The parameters can be set for the signal frequency of this output and the torque value corresponding to a cyclical ratio of 100% (scaling).

- If cyclical ratio = 0% → Braking torque supplied = "S2 torque".
- If cyclical ratio = 50% → Torque supplied = 0 mNm.
- If cyclical ratio = 100% → Motor torque supplied = "S2 torque".



**Figure 246**

Combinations of digital outputs 3 & 4 "Motor status": Used to find out the motor status.

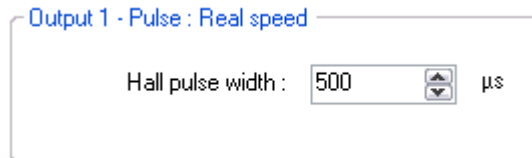


**Figure 247**

### 12.2.6.8. Type 9 "Outputs" Tab Parameters

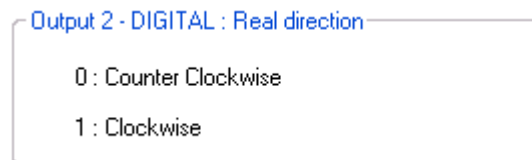
Setting the parameters of Pulse output 1 "Real speed": A Hall pulse with configurable width (100 to 800  $\mu$ s) is generated each time one of the 3 motor Hall sensors changes state.

80140\_SMi21 and 80180\_SMi21 motors have 12 Hall pulses per revolution (2 pairs of poles).  
The 80280\_SMi21 motor has 24 Hall pulses per revolution (4 pairs of poles).



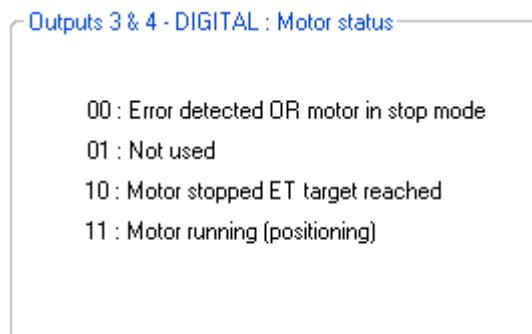
**Figure\_248**

State of digital output 2 "Real direction": Used to find out the motor direction of rotation.



**Figure\_249**

Combinations of digital outputs 3 & 4 "Motor status": Used to find out the motor status.



**Figure\_250**

### 12.2.6.9. "Tuning" Tab Parameters

Selection of the various parameters to be represented in graphic form: either 1, 2, 3 or 4 parameters. The system position response (measurement vs setpoint) can therefore be compared while displaying changes in the current and the speed.

- Real Speed
- Real Torque
- Current Position
- Position setpoint

**Figure 251**

Set the PID controller factors in the position control loop (this function is reserved for advanced users). The values given in the example below ensure correct product operation in the majority of cases.

Position control loop parameters

Kp =       Ki =

Kd =

**Figure 252**

It is possible to set the recording time you wish to view, from 1 to 300 seconds. The sampling interval is 10 ms. During data acquisition, the other HMI functions are not available.

Recording time :  Second(s)

**Figure 253**

"Curve Drawing" button: used to start data acquisition. Curves are only displayed once acquisition is complete.

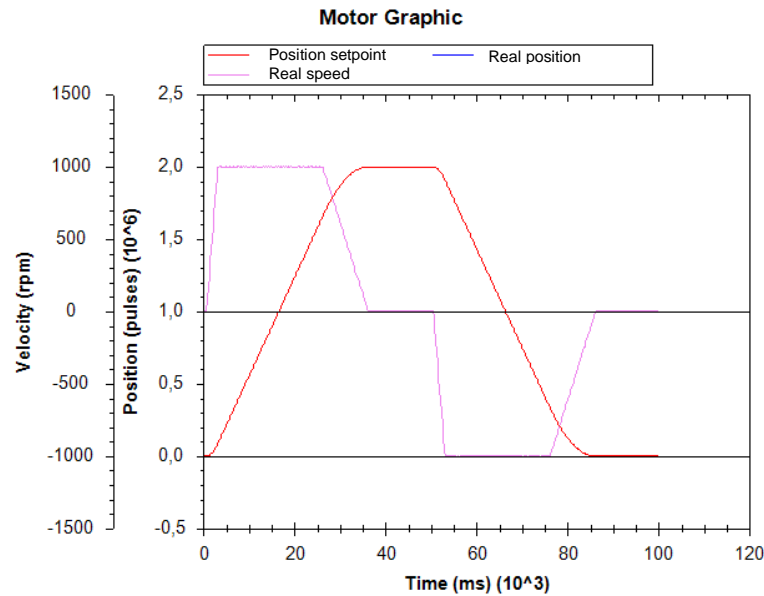
"Export Data" button: used to retrieve data corresponding to the selected parameters in a text file (.txt). To make this file compatible with the Excel spreadsheet, change its extension to .csv.

**Figure 254**

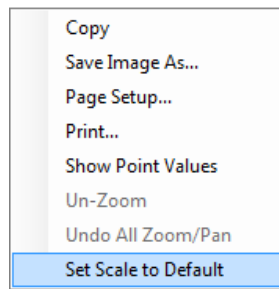
Example:

- Position 1: 2,000,000 points, acceleration ramp 400 rpm/sec, speed step 1000 rpm, deceleration ramp 100 rpm/sec.
- Position 2: 0 points, acceleration ramp 400 rpm/sec, speed step 1000 rpm, deceleration ramp 100 rpm/sec. This gives us the following graphic representation:



**Figure 255**

Note: The display scales can be changed with the mouse wheel. Other functions are available by right-clicking the mouse.



**Figure 256**

12.2.6.10. "Limits" Tab Parameters

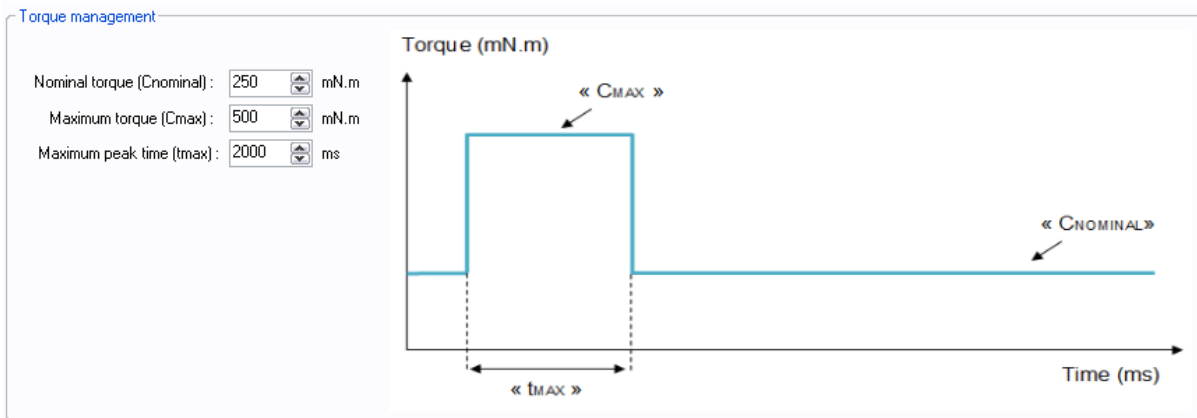
**WARNING**

**UNEXPECTED MOVEMENT**  
 An inappropriate setting for the torque values can result in unexpected movements of the application and destruction of the motor.

- Make sure this will not cause any damage.
- Do not continue with the test if there is anyone or any obstacle in the hazardous zone.

**Failure to comply with these precautions will result in death, serious injury or equipment damage.**

This tab can be used to set the limit values for various parameters.



**Figure 257**

Setting the various torque parameters: When the application torque exceeds the torque " $C_{NOMINAL}$ ", the motor can provide torque up to the value " $C_{MAX}$ " for the maximum duration " $t_{MAX}$ ". Thereafter, if the application torque is still higher than " $C_{NOMINAL}$ ", the motor torque is limited to the value " $C_{NOMINAL}$ " until the application torque falls back below this value.

**WARNING**

**VOLTAGE SURGES**  
 During the braking phases, the motor generates voltage surges.

- Check that its voltage surges can be tolerated by the other devices connected to the same power supply.
- Use an external circuit to limit voltage surges if the brake is being used intensively.

**Failure to comply with these precautions will result in death, serious injury or equipment damage.**

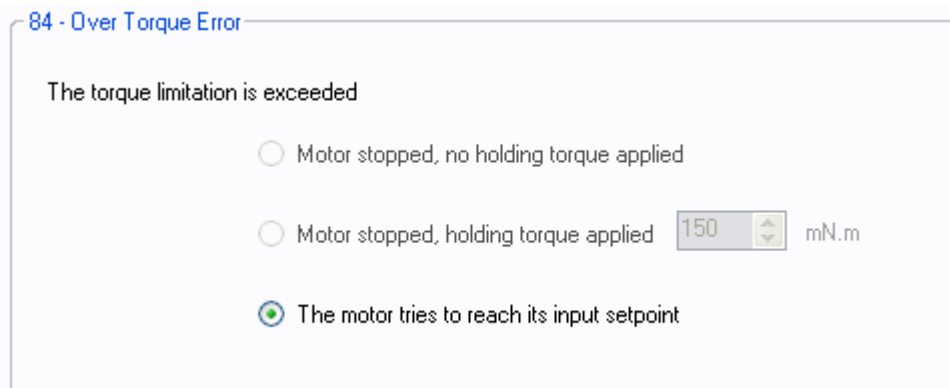
Setting the overvoltage detection threshold parameter: If the voltage at the motor terminals exceeds this threshold, an error is generated, the motor is stopped and no holding torque is applied (freewheeling).

Overvoltage detection

Threshold voltage :  V

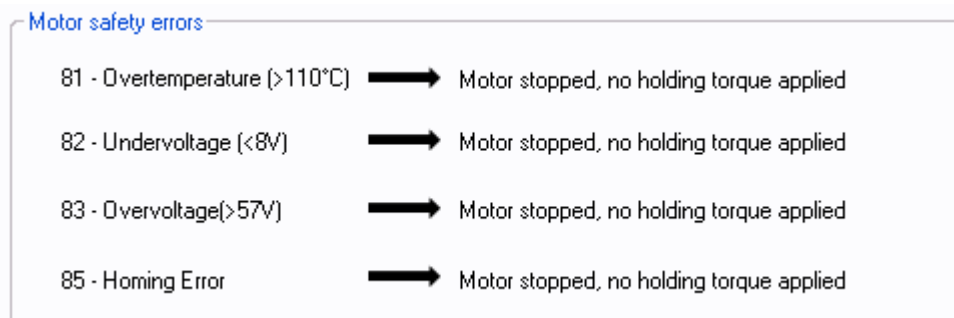
### 12.2.6.11. "Errors" Tab Parameters

Setting the parameters for the action to be taken when an overtorque error is encountered: real torque higher than the nominal torque "C<sub>NOMINAL</sub>" for a time longer than "t<sub>MAX</sub>".



**Figure 258**

For all errors affecting motor safety, the action to be taken cannot be configured: in the event of an error, the motor stops, and no holding torque is applied (freewheeling).



**Figure 259**

Procedure for restarting the motor following detection of an error:

- Eliminate the cause of the fault.
- Switch to stop mode: disable digital input 6 "On/Off".
- Switch back to run mode: enable digital input 6 "On/Off".



## 12.2.7. Expert Program P111


### 12.2.7.1. Description

Expert program P111 is used to:

- Perform a homing phase to initialize the system with detection of the limit switches (switch or mechanical type). A single switch type contact is managed in this program.
- Perform various positionings using 1 to 30 preset setpoint positions, each corresponding to a specific combination of digital inputs "In1" to "In5".
- Set the acceleration/deceleration phases and the maximum speed that must not be exceeded between each point via the HMI.

### 12.2.7.2. "Homing" Tab Parameters

Set the polarity of the switch wired on digital input "In6":



Switch Status

High state active     Low state active

**Figure 260**

Set the difference in position (in pulses) between the mechanical stops and the application total stroke limits: stop 1 (END1) represents the stroke start, stop 2 (END2) represents the stroke end.

Note: Where there is only one mechanical stop, the "Offset 2" parameter is not available.



Offset (pulses)

Offset 1 1000    Offset 2 1000

**Figure 261**

Set the search speed for stops during the homing phase.



Homing Speed

100 rpm

**Figure 262**

Set the homing torque that allows the mechanical stop to be found by detection of over-torque.



Homing Torque

100 mN.m

**Figure 263**

Set the maximum permitted time for the homing phase. If this value is exceeded, an error will be generated.  
Time limited to 300 s.



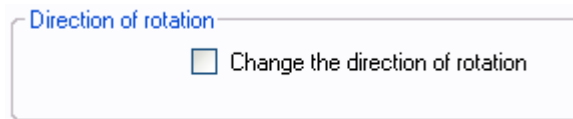
Max Homing Time

300   second

**Figure 264**

Set the direction of rotation for the first stop search.

N.B.: By default, the motor runs forward (CW).



Direction of rotation

Change the direction of rotation

**Figure 265**

12.2.7.3. "Inputs" Tab Parameters

Information concerning the polarity of the switch wired on digital input 6. This polarity is selected in the "Homing" tab (see above).



**Figure 266**

Select the number of position setpoints to be preset (see table below).

Number of position setpoints :



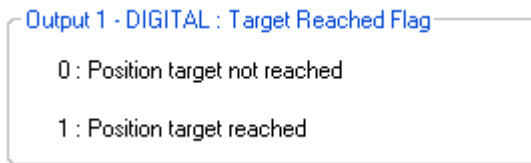
**Figure 267**

Position Index	IN1	IN2	IN3	IN4	IN5	Position (pulses)	Speed (rpm)	Acceleration (rpm/s)	Deceleration (rpm/s)
<b>Stop</b>	0	0	0	0	0	1	1	1	1
<b>Start Homi...</b>	1	0	0	0	0	1	1000	40000	40000
<b>Position 1</b>	0	1	0	0	0	1000	1000	40000	40000
<b>Position 2</b>	1	1	0	0	0	2000	1000	40000	40000
<b>Position 3</b>	0	0	1	0	0	3000	1000	40000	40000
<b>Position 4</b>	1	0	1	0	0	4000	1000	40000	40000
<b>Position 5</b>	0	1	1	0	0	5000	1000	40000	40000
<b>Position 6</b>	1	1	1	0	0	6000	1000	40000	40000
<b>Position 7</b>	0	0	0	1	0	7000	1000	40000	40000
<b>Position 8</b>	1	0	0	1	0	8000	1000	40000	40000
<b>Position 9</b>	0	1	0	1	0	9000	1000	40000	40000
<b>Position 10</b>	1	1	0	1	0	10000	1000	40000	40000
<b>Position 11</b>	0	0	1	1	0	11000	1000	40000	40000
<b>Position 12</b>	1	0	1	1	0	12000	1000	40000	40000
<b>Position 13</b>	0	1	1	1	0	13000	1000	40000	40000
<b>Position 14</b>	1	1	1	1	0	14000	1000	40000	40000
<b>Position 15</b>	0	0	0	0	1	15000	1000	40000	40000
<b>Position 16</b>	1	0	0	0	1	16000	1000	40000	40000
<b>Position 17</b>	0	1	0	0	1	17000	1000	40000	40000

**Figure 268**

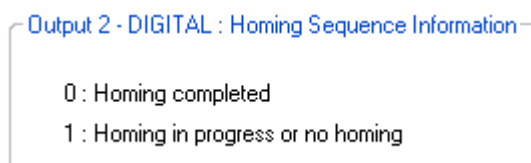
#### 12.2.7.4. Type 5 "Outputs" Tab Parameters

State of digital output 1 "Target Reached Flag": Used to find out whether the position setpoint has been reached.



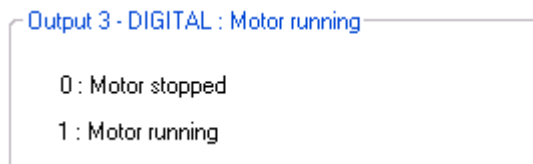
**Figure 269**

State of digital output 2 "Homing Sequence Information": Used to find out how the homing phase is progressing: completed, in progress or not performed.



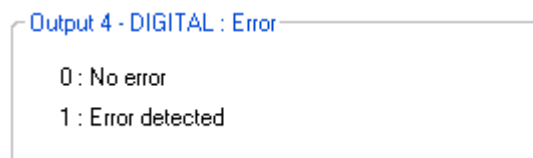
**Figure 270**

State of digital output 3 "Motor running": Used to find out whether the motor is stopped or running.



**Figure 271**

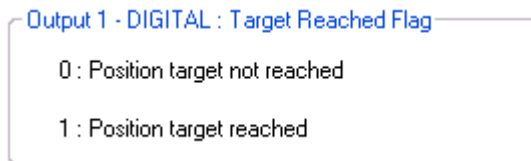
State of digital output 4 "Error": Used to find out whether an error has been detected.



**Figure 272**

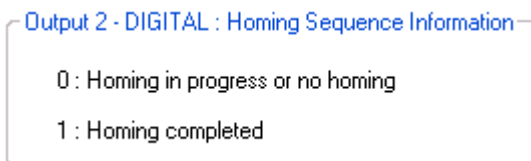
### 12.2.7.5. Type 6 "Outputs" Tab Parameters

State of digital output 1 "Target Reached Flag": Used to find out whether the position setpoint has been reached.



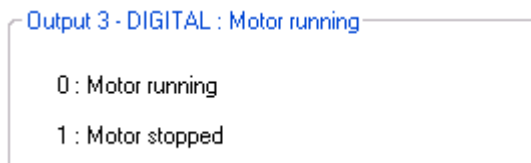
**Figure 273**

State of digital output 2 "Homing Sequence Information": Used to find out how the homing phase is progressing: completed, in progress or not performed.



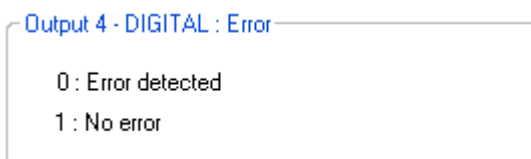
**Figure 274**

State of digital output 3 "Motor running": Used to find out whether the motor is stopped or running.



**Figure 275**

State of digital output 4 "Error": Used to find out whether an error has been detected.



**Figure 276**

12.2.7.6. Type 7 "Outputs" Tab Parameters

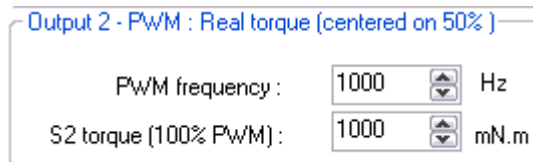
State of digital output 1 "Target Reached Flag": Used to find out whether the position setpoint has been reached.



**Figure 277**

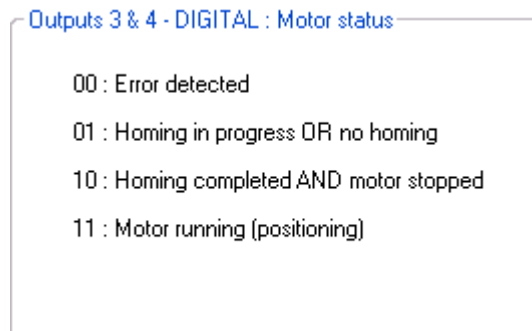
Setting the parameters of PWM output 2 "Real torque (centered on 50%)": The parameters can be set for the signal frequency of this output and the torque value corresponding to a cyclical ratio of 100% (scaling).

- If cyclical ratio = 0% → Braking torque supplied = "S2 torque".
- If cyclical ratio = 50% → Torque supplied = 0 mNm.
- If cyclical ratio = 100% → Motor torque supplied = "S2 torque".



**Figure 278**

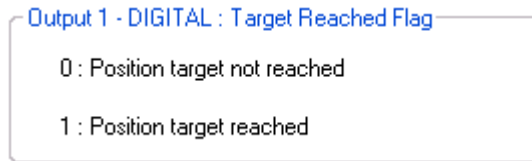
Combinations of digital outputs 3 & 4 "Motor status": Used to find out the motor status.



**Figure 279**

12.2.7.7. Type 8 "Outputs" Tab Parameters

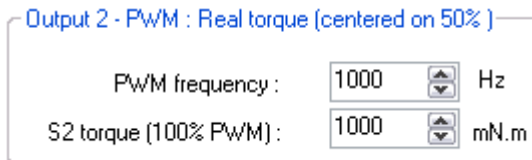
State of digital output 1 "Target Reached Flag": Used to find out whether the position setpoint has been reached.



**Figure 280**

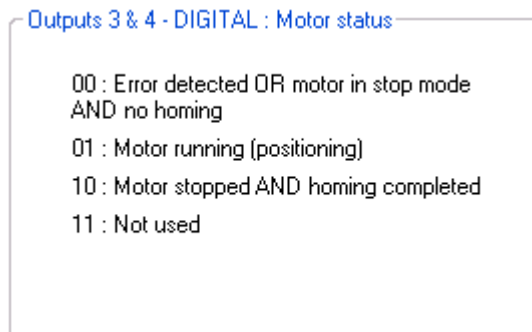
Setting the parameters of PWM output 2 "Real torque (centered on 50%)": The parameters can be set for the signal frequency of this output and the torque value corresponding to a cyclical ratio of 100% (scaling).

- If cyclical ratio = 0% → Braking torque supplied = "S2 torque".
- If cyclical ratio = 50% → Torque supplied = 0 mNm.
- If cyclical ratio = 100% → Motor torque supplied = "S2 torque".



**Figure 281**

Combinations of digital outputs 3 & 4 "Motor status": Used to find out the motor status.



**Figure 282**

### 12.2.7.8. Type 9 "Outputs" Tab Parameters

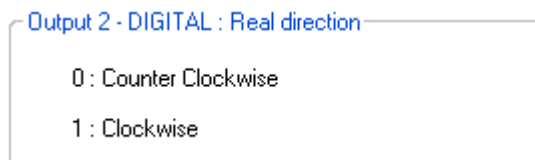
Setting the parameters of Pulse output 1 "Real speed": A Hall pulse with configurable width (100 to 800  $\mu$ s) is generated each time one of the 3 motor Hall sensors changes state.

80140\_SMi21 and 80180\_SMi21 motors have 12 Hall pulses per revolution (2 pairs of poles).  
The 80280\_SMi21 motor has 24 Hall pulses per revolution (4 pairs of poles).



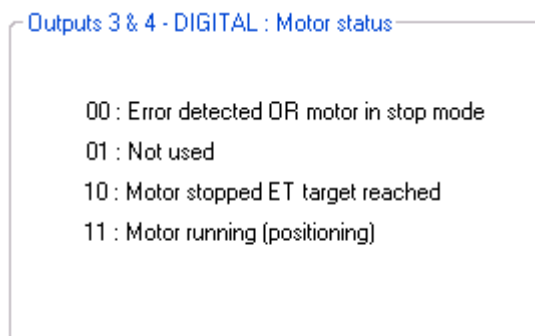
**Figure 283**

State of digital output 2 "Real direction": Used to find out the motor direction of rotation.



**Figure 284**

Combinations of digital outputs 3 & 4 "Motor status": Used to find out the motor status.



**Figure 285**



### 12.2.7.9. "Tuning" Tab Parameters

Selection of the various parameters to be represented in graphic form: either 1, 2, 3 or 4 parameters. The system position response (measurement vs setpoint) can therefore be compared while displaying changes in the current and the speed.

- Real speed
- real torque
- Current position
- Position setpoint

**Figure 286**

Set the PID controller factors in the position control loop (this function is reserved for advanced users). The values given in the example below ensure correct product operation in the majority of cases.

Position control loop parameters

Kp =       Ki =

Kd =

**Figure 287**

It is possible to set the recording time you wish to view, from 1 to 300 seconds. The sampling interval is 10 ms. During data acquisition, the other HMI functions are not available.

Recording time :  Second(s)

---

**Figure 288**

"Curve Drawing" button: used to start data acquisition. Curves are only displayed once acquisition is complete.

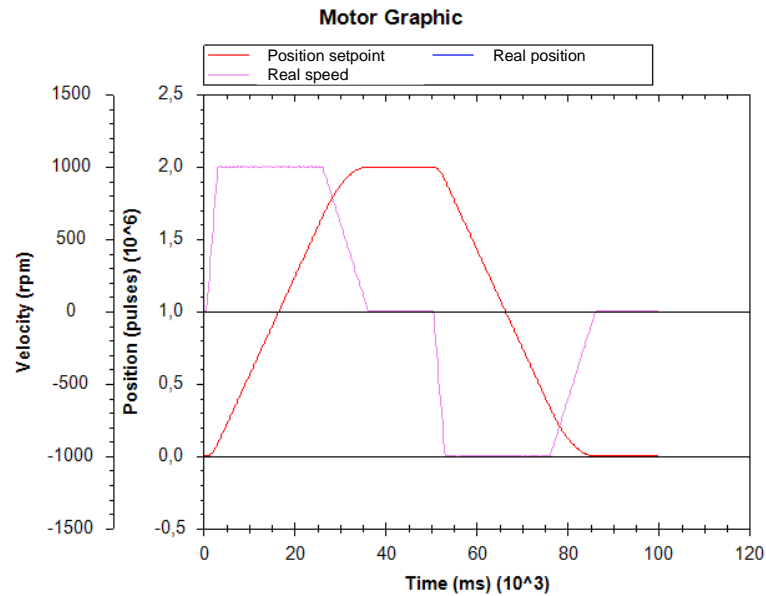
"Export Data" button: used to retrieve data corresponding to the selected parameters in a text file (.txt). To make this file compatible with the Excel spreadsheet, change its extension to .csv.

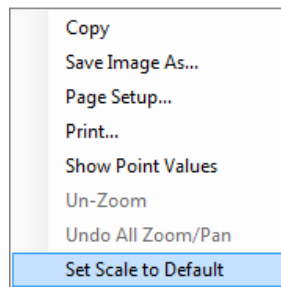
**Figure 289**

Example:

- Position 1: 2,000,000 points, acceleration ramp 400 rpm/sec, speed step 1000 rpm, deceleration ramp 100 rpm/sec.
- Position 2: 0 points, acceleration ramp 400 rpm/sec, speed step 1000 rpm, deceleration ramp 100 rpm/sec. This gives us the following graphic representation:




Note: The display scales can be changed with the mouse wheel. Other functions are available by right-clicking the mouse.



**Figure 290**

12.2.7.10. "Limits" Tab Parameters

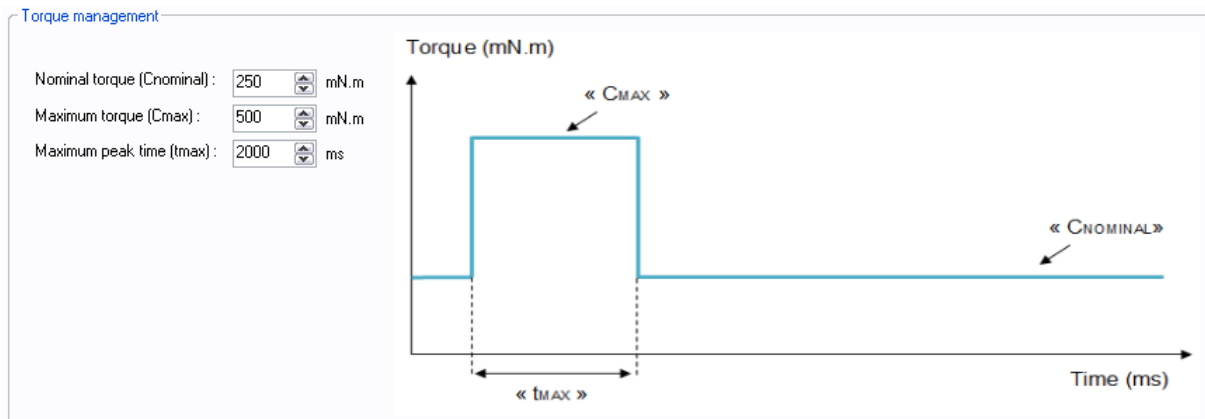
 **WARNING**

**UNEXPECTED MOVEMENT**  
An inappropriate setting for the torque values can result in unexpected movements of the application and destruction of the motor.

- Make sure this will not cause any damage.
- Do not continue with the test if there is anyone or any obstacle in the hazardous zone.


**Failure to comply with these precautions will result in death, serious injury or equipment damage.**

This tab can be used to set the limit values for various parameters.



**Figure 291**

Setting the various torque parameters: When the application torque exceeds the torque " $C_{NOMINAL}$ ", the motor can provide torque up to the value " $C_{MAX}$ " for the maximum duration " $t_{MAX}$ ". Thereafter, if the application torque is still higher than " $C_{NOMINAL}$ ", the motor torque is limited to the value " $C_{NOMINAL}$ " until the application torque falls back below this value.

 **WARNING**

**VOLTAGE SURGES**  
During the braking phases, the motor generates voltage surges.

- Check that its voltage surges can be tolerated by the other devices connected to the same power supply.
- Use an external circuit to limit voltage surges if the brake is being used intensively.

**Failure to comply with these precautions will result in death, serious injury or equipment damage.**

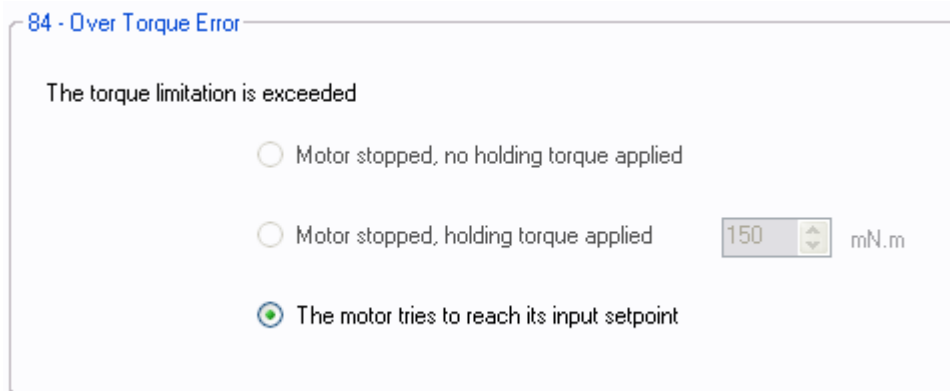
Setting the overvoltage detection threshold parameters: If the voltage at the motor terminals exceeds this threshold, an error is generated, the motor is stopped and no holding torque is applied (freewheeling).

Overvoltage detection

Threshold voltage :  V

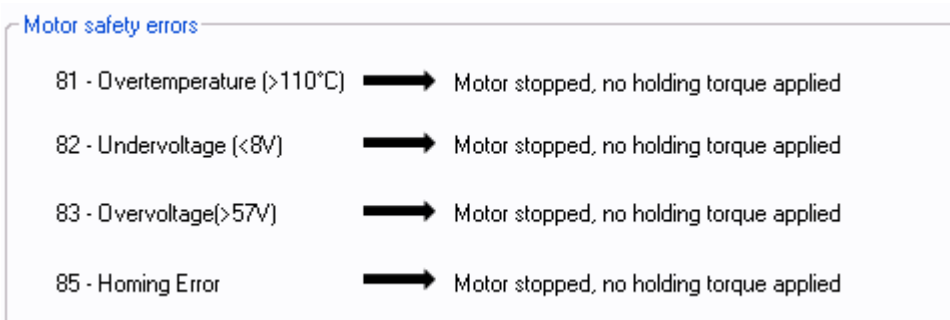
### 12.2.7.11. "Errors" Tab Parameters

Setting the parameters for the action to be taken when an over-torque error is encountered: real torque higher than the nominal torque "C<sub>NOMINAL</sub>" for a time longer than "t<sub>MAX</sub>".



**Figure 292**

For all errors affecting motor safety, the action to be taken cannot be configured: in the event of an error, the motor is stopped and no holding torque is applied (freewheeling).



**Figure 293**

Procedure for restarting the motor following detection of an error:

- Eliminate the cause of the fault.
- Switch to stop mode: disable digital inputs 1 to 5.
- Switch back to run mode: enable one of digital inputs 1 to 5.

12.2.8. Description of the P200 Various Tabs

For the description of tabs, expert program P201 is used as an example (for detailed information about each position expert program, see the "Expert Program P201" and "Expert Program P202" sections in this document).

12.2.8.1. Home Page

This page is common to all the expert and application programs, whether in speed, position or torque mode. It can be used to choose between the various types of application and expert programs.

In our example, we have chosen the "Position P200" category in the "Expert Programs" group, so the icons for the various P200 expert programs appear in the bottom right-hand corner of the window, and you then need to click on the one corresponding to the "P201" expert program:

Concise description of the P201 expert program

Expert program category selection: P200

Expert program selection: P201

The screenshot shows the DCmind Soft application window. At the top, there is a menu bar with 'File', 'Language', 'Bootloader', 'Motor Information', 'Motor Connection', and 'Help'. Below the menu is the Crouzet logo and navigation arrows. The main interface is divided into several sections:

- Application Programs:** A tree view on the left containing 'Valve', 'Conveyor Belt', and 'Machine'.
- Experts Programs:** A tree view on the left containing 'Position P100', 'Position P200' (highlighted), 'Speed V100', and 'Torque C100'.
- Main Display Area:** Contains two large icons for 'Valve 4 positions' and 'Valve 30 positions'. Below these are two smaller icons for expert programs 'P201' and 'P202'. Each icon shows a motor and a control panel with inputs: '+5Vdc', '+24 Vdc', 'In1 ON/OFF', 'In2 Homing', 'In3 Live', 'In3 Switch', 'In4 Select speed', 'In5 Big position', and 'In6 Fine position'. The output is labeled '0/10V Position'.
- Information Panel:** A text box on the right provides details for 'Expert program P201':
  - do homing phase for system initialization with end strokes detection.
  - do an analog positioning using two 0-10V setpoints : big tuning & fine tuning
  - number of positions can be adjust between 2048 to 65536 positions

**Figure 294**

12.2.8.2. "Description" Tab

This is an information tab containing a concise description of the various position profiles that are created using this expert mode:

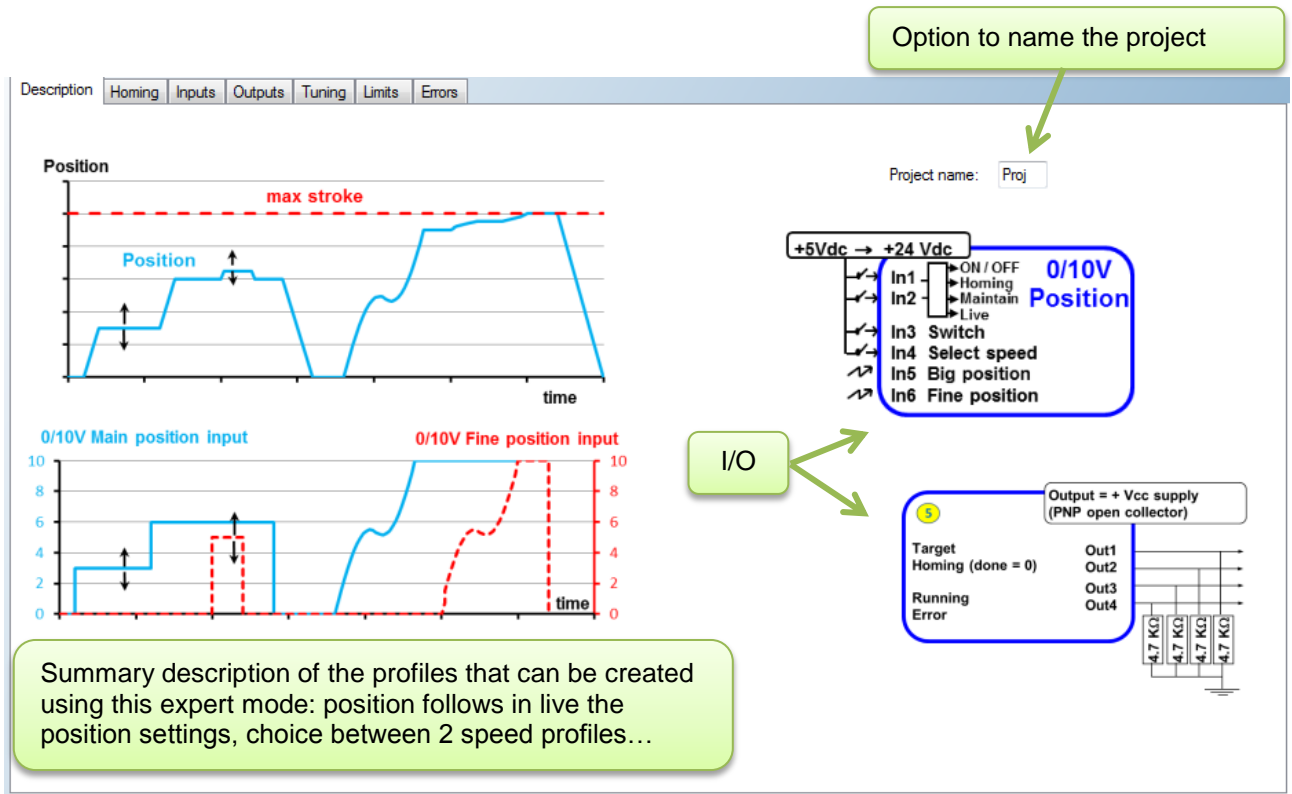


Figure 295

### 12.2.8.3. "Homing" Tab

This tab is used to select and configure the type of homing to be performed: offset(s), speed, homing torque, maximum duration of the homing phase, motor direction of rotation to search for the 1st stop.

**Figure 296**

### 12.2.8.4. "Inputs" Tab

This tab is used to configure the various inputs in this expert mode (speed profile : max speed, acceleration, deceleration ; application stroke...).

**Figure 297**

12.2.8.5. "Outputs" Tab

This tab is used to select and configure the various outputs in this expert mode (position type 5 to type 9):

The screenshot shows the 'Outputs' configuration interface with the following settings visible:

- Output 1 - PULSE : Real speed**: Largeur du top hall: 500  $\mu$ s
- Output 1 - PWM : Real Speed**: PWM frequency: 1000 Hz
- Output 1 - FREQUENCY : Real Speed**: Frequency at 1000 rpm: [ ] Hz
- Output 1 - PWM : Real speed (centered on 50%)**: PWM frequency: 1000 Hz
- Output 1 - DIGITAL : Target Reached Flag**: 0: Position target not reached, 1: Position target reached
- Output 2 - PWM : Real Torque**: PWM frequency: 1000 Hz, S2 torque (100% PWM): 1000 mN.m
- Output 2 - PWM : Real Torque**: PWM frequency: 1000 Hz, S2 torque (100% PWM): 1000 mN.m
- Output 2 - DIGITAL : Real direction**: 0: Counter Clockwise, 1: Clockwise
- Output 2 - PWM : Real torque (centered on 50%)**: PWM frequency: 1000 Hz, S2 torque (100% PWM): 1000 mN.m
- Output 2 - DIGITAL : Homing Sequence Information**: 0: Homing completed, 1: Homing in progress or no homing
- Output 3 - DIGITAL : Real direction**: 0: Counter Clockwise, 1: Clockwise
- Output 3 - DIGITAL : Motor Running**: 0: motor running, 1: motor stopped
- Output 3 - DIGITAL : Motor Running**: 0: motor running, 1: motor stopped
- Outputs 3 & 4 - DIGITAL : Motor status**: 00: Error detected, 01: Motor running, 10: Motor stopped and holding torque applied, 11: Motor stopped without holding
- Output 3 - DIGITAL : Motor running**: 0: Motor stopped, 1: Motor running
- Output 4 - DIGITAL : Error**: 0: Error detected, 1: No error
- Output 4 - DIGITAL : Error**: 0: Error detected, 1: No error
- Output 4 - DIGITAL : Error**: 0: Error detected, 1: No error
- Output 4 - DIGITAL : Error**: 0: Error detected, 1: No error

Callout boxes below the interface:

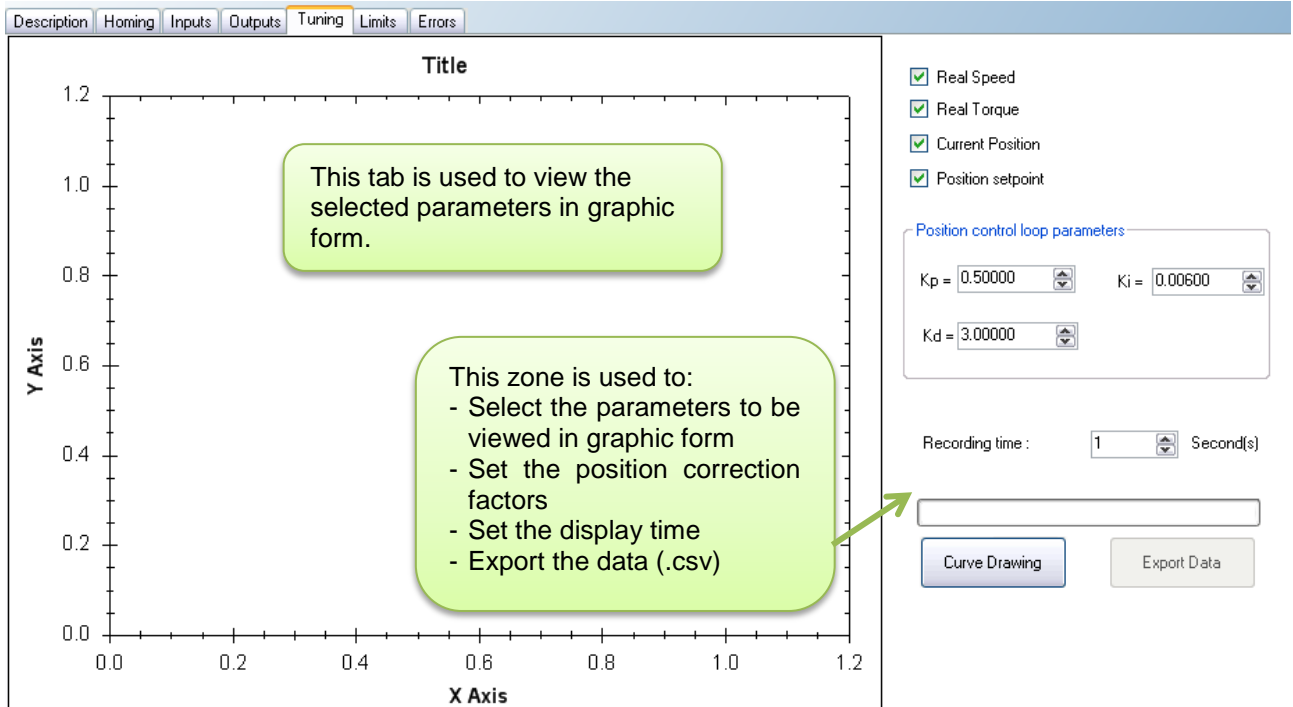
- Output 5 type parameter settings** (points to Output 4 - DIGITAL : Error)
- Output 6 type parameter settings** (points to Output 4 - DIGITAL : Error)
- Output 7 type parameter settings** (points to Output 4 - DIGITAL : Error)
- Output 8 type parameter settings** (points to Outputs 3 & 4 - DIGITAL : Motor status)
- Output 9 type parameter settings** (points to Output 4 - DIGITAL : Error)

Figure 298



### 12.2.8.6. "Tuning" Tab

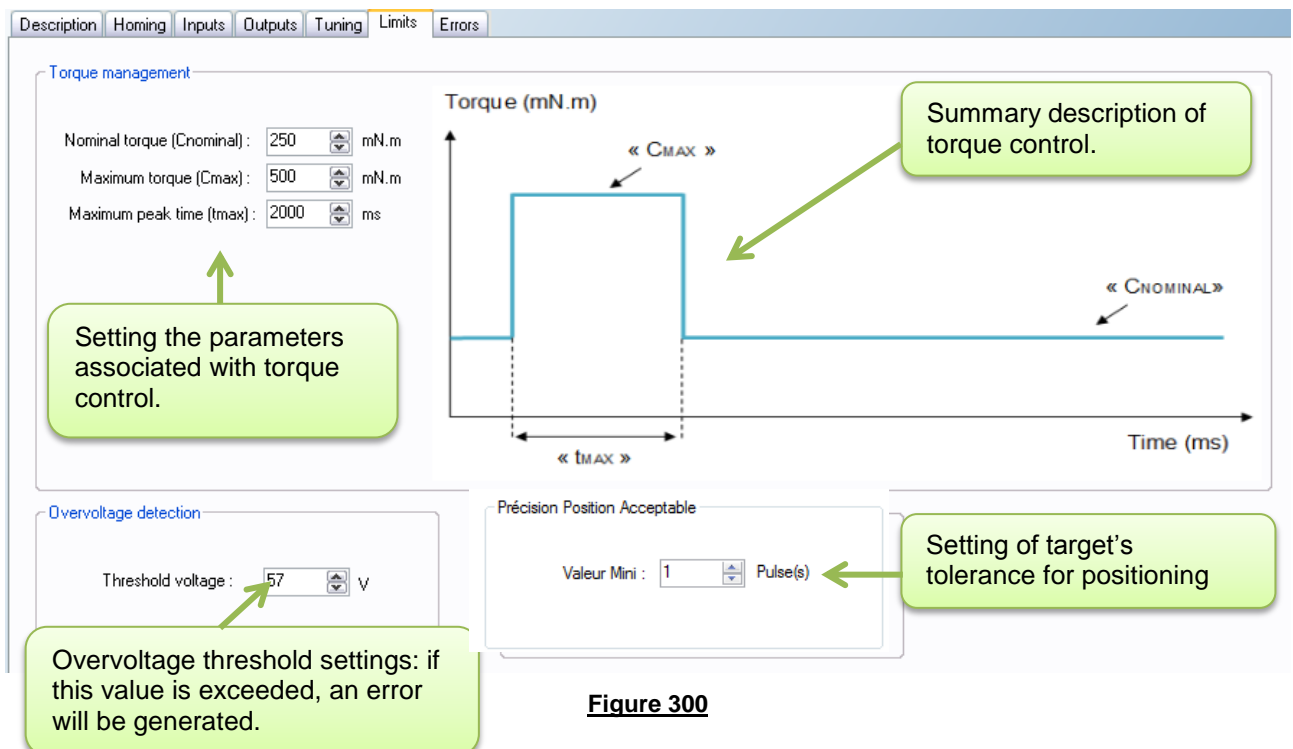
This tab is used to represent some parameters (speed, position, torque, etc.) in graphic form and modify the position control loop coefficients. It is common to all the position expert programs.



**Figure 299**

### 12.2.8.7. "Limits" Tab

This tab is used to configure the various motor operating limits: nominal and maximum torque (torque peak authorization), the power supply overvoltage threshold and the required accuracy for the positioning.



**Figure 300**

12.2.8.8. "Errors" Tab

This tab provides information about the type of error encountered (based on the error code) and the action to be taken by the motor following this error.

Motor actions can be set when Over torque error or Position target error are detected (\*not available, optional only).

Setting the action to be taken when an over torque error is encountered (\*optional).

Motor action selection when a target error is detected (\*optional).

Procedure for restarting the motor following detection of an error:

- Eliminate the cause of the fault.
- Switch to stop mode and then back to run mode.

**Figure 301**

## 12.2.9. Expert Program P201

### 12.2.9.1. Description

P201 expert program allows to:

- Perform a homing phase to initialize the system with detection of the stroke ends (mechanical stop or switch limit).
- Perform positioning in using two 0/10V analog inputs: One for coarse tuning and second for thin tuning. The total stroke (which has to be set per the user in this program) can be cut up to 65536 positions. The targeted position follows in live the 2 inputs.
- Select a speed profile (choice between 2 profiles) to go from a position to another position. A speed profile contains acceleration, deceleration and maximum allowed speed values.

### 12.2.9.2. "Homing" Tab Parameters

Set the polarity of the switch wired on digital input "In3":



Switch Status

High state active     Low state active

**Figure 302**

Set the difference in position (in pulses) between the mechanical stops and the application total stroke limits: stop 1 (END1) represents the stroke start, stop 2 (END2) represents the stroke end.

Note: Where there is only one mechanical stop, the "Offset 2" parameter is not available.



Offset (pulses)

Offset 1 1000    Offset 2 1000

**Figure 303**

Set the search speed for stops during the homing phase.



Homing Speed

100 rpm

**Figure 304**

Set the homing torque that allows the mechanical stop to be found by detection of over-torque.

Homing Torque

  mN.m

**Figure\_305**

Set the maximum permitted time for the homing phase. If this value is exceeded, an error will be generated. Time limited to 300 s.

Max Homing Time

  second

**Figure\_306**

Set the direction of rotation for the first stop search.

N.B.: By default, the motor runs forward (CW).

Direction of rotation

 Change the direction of rotation

**Figure\_307**

12.2.9.3. "Inputs" Tab Parameters

Combinations of digital inputs 1 and 2: Used to choose the motion to be performed from the 4 actions indicated below.

Input 1 and 2 - Digital: move selection

I1	I2	Action
<input type="checkbox"/> 0	<input type="checkbox"/> 0	Stop and error cancelation
<input type="checkbox"/> 1	<input type="checkbox"/> 0	Do homing phase
<input type="checkbox"/> 0	<input type="checkbox"/> 1	Target actual position
<input type="checkbox"/> 1	<input type="checkbox"/> 1	Target position from inputs 5 and 6

**Figure 308**

Information concerning the polarity of the switch wired on digital input 3. This polarity is selected in the "Homing" tab (see above).

Input 3 - DIGITAL - Switch

High state active  
 Low state active

**Figure 309**

Digital input 4 - IN4 : Used to select one of the two speed profile.

To go from a position to a new position, motor follows a trapezoidal trajectory. This trajectory uses the maximum speed, acceleration and deceleration which are set in the « Digital speed profile selection » zone.

Input 4 - Digital: speed profile selection

	Speed (rpm)	Acceleration (rpm/s)	Deceleration (rpm/s)
Profile 1:	<input type="text" value="500"/>	<input type="text" value="50"/>	<input type="text" value="50"/>
Profile 2:	<input type="text" value="2500"/>	<input type="text" value="1000"/>	<input type="text" value="1000"/>

**Figure 310**

**NB** : If the user needs to change its velocity profile during a positioning phase, it is strongly recommended to use the same deceleration slope for both velocity profiles to avoid overruns targets.

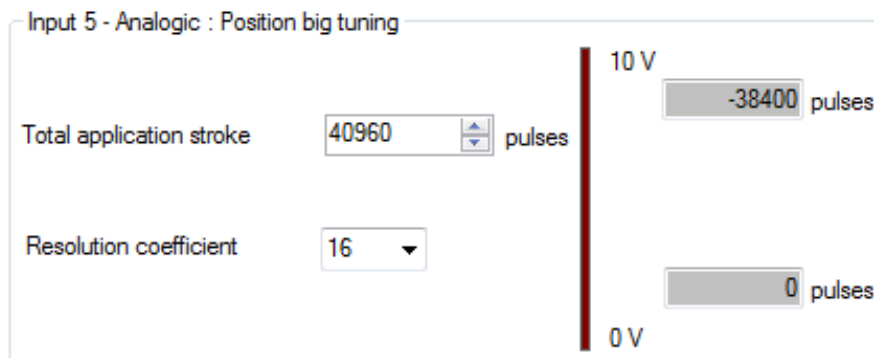
Input IN5 and IN6 setpoints: To do the position setting using the two 0-10V analog inputs.

Parameter « total stroke length » is the number of encoder pulses corresponding to the stroke when IN5 and IN6 are at 10V.

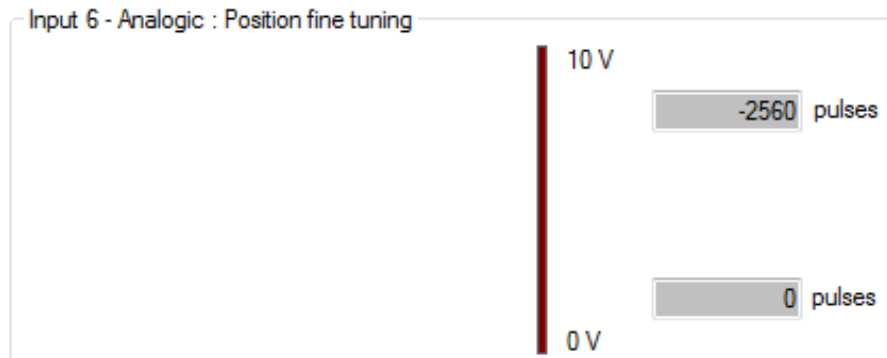
Parameter “resolution coefficient” allows to cut the « total stroke length » in 2,048 or 4,096 or 8,192 or 16,384 or 32,768 or 65,536 positions.

The distribution of the « Total stroke length » on the two analog setpoint inputs is carried out according to the rules below.

- On IN5 :  $[0 - 10V] \equiv [0 ; Stroke_{total\_application} \times \frac{Coefficient\_resolution - 1}{Coefficient\_resolution}]$  coded on 1024 points (coarse setting)
- On IN6 :  $[0 - 10V] \equiv [0 ; Course_{totale\_application} \times \frac{1}{Coefficient\_résolution}]$  coded on 1024 points (thin setting)



**Figure 311**



**Figure 312**

The motor position setpoint is the addition of position setpoint of IN5 and of position setpoint of IN6.

In above example :

- On IN5 :  $[0 - 10V] \equiv [0 ; 40960 \times \frac{16-1}{16}] = [0 ; 38400]$  coded on 1,024 points (coarse setting)
- On IN6 :  $[0 - 10V] \equiv [0 ; 40960 \times \frac{1}{16}] = [0 ; 2560]$  coded on 1,024 points (thin setting)

Note : The sign (-) at the 10V setpoint depends from the direction of rotation during the homing sequence.

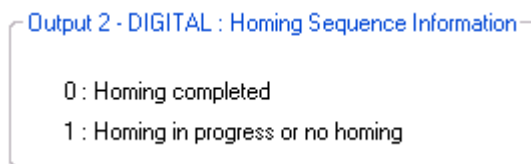
#### 12.2.9.4. Type 5 "Outputs" Tab Parameters

State of digital output 1 "Target Reached Flag": Used to find out whether the position setpoint has been reached.



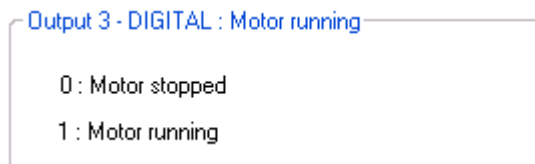
**Figure 313**

State of digital output 2 "Homing Sequence Information": Used to find out how the homing phase is progressing: completed, in progress or not performed.



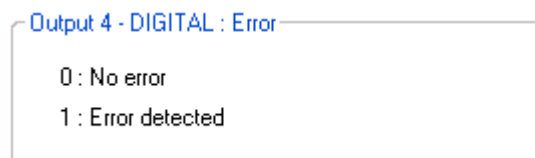
**Figure 314**

State of digital output 3 "Motor running": Used to find out whether the motor is stopped or running.



**Figure 315**

State of digital output 4 "Error": Used to find out whether an error has been detected.



**Figure 316**

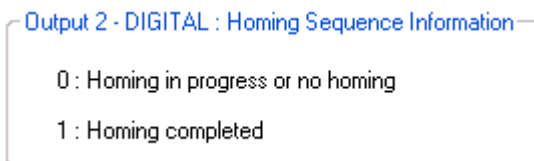
### 12.2.9.5. Type 6 "Outputs" Tab Parameters

State of digital output 1 "Target Reached Flag": Used to find out whether the position setpoint has been reached.



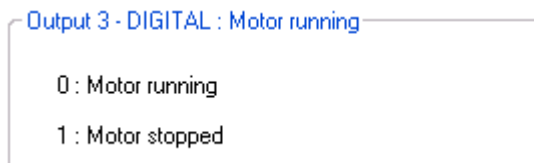
**Figure 317**

State of digital output 2 "Homing Sequence Information": Used to find out how the homing phase is progressing: completed, in progress or not performed.



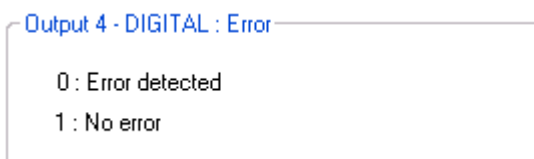
**Figure 318**

State of digital output 3 "Motor running": Used to find out whether the motor is stopped or running.



**Figure 319**

State of digital output 4 "Error": Used to find out whether an error has been detected.



**Figure 320**



## 12.2.9.6. Type 7 "Outputs" Tab Parameters

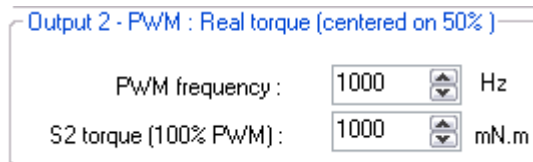
State of digital output 1 "Target Reached Flag": Used to find out whether the position setpoint has been reached.



**Figure 321**

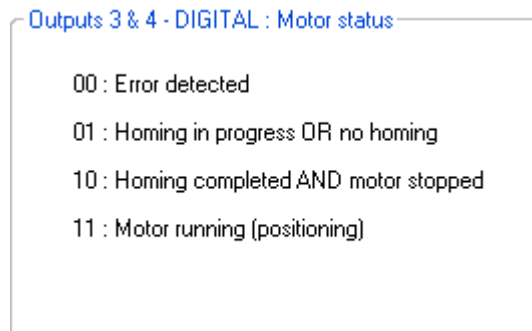
Setting the parameters of PWM output 2 "Real torque (centered on 50%)": The parameters can be set for the signal frequency of this output and the torque value corresponding to a cyclical ratio of 100% (scaling).

If cyclical ratio = 0% → Braking torque supplied = "S2 torque".  
 If cyclical ratio = 50% → Torque supplied = 0 mNm.  
 If cyclical ratio = 100% → Motor torque supplied = "S2 torque".



**Figure 322**

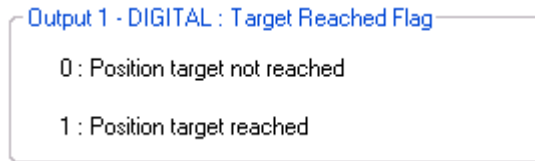
Combinations of digital outputs 3 & 4 "Motor status": Used to find out the motor status.



**Figure 323**

## 12.2.9.7. Type 8 "Outputs" Tab Parameters

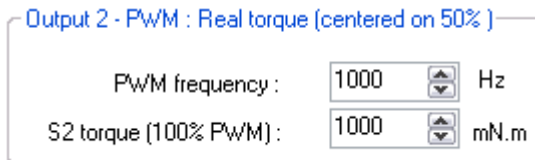
State of digital output 1 "Target Reached Flag": Used to find out whether the position setpoint has been reached.



**Figure 324**

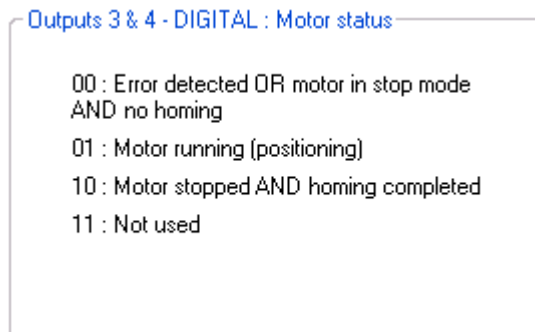
Setting the parameters of PWM output 2 "Real torque (centered on 50%)": The parameters can be set for the signal frequency of this output and the torque value corresponding to a cyclical ratio of 100% (scaling).

- If cyclical ratio = 0% → Braking torque supplied = "S2 torque".
- If cyclical ratio = 50% → Torque supplied = 0 mNm.
- If cyclical ratio = 100% → Motor torque supplied = "S2 torque".



**Figure 325**

Combinations of digital outputs 3 & 4 "Motor status": Used to find out the motor status.



**Figure 326**

### 12.2.9.8. Type 9 "Outputs" Tab Parameters

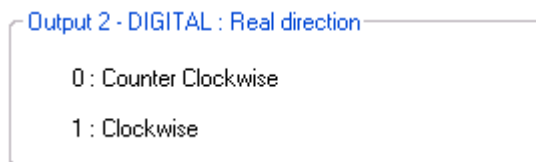
Setting the parameters of Pulse output 1 "Real speed": A Hall pulse with configurable width (100 to 800  $\mu$ s) is generated each time one of the 3 motor Hall sensors changes state.

80140\_SMi21 and 80180\_SMi21 motors have 12 Hall pulses per revolution (2 pairs of poles).  
The 80280\_SMi21 motor has 24 Hall pulses per revolution (4 pairs of poles).



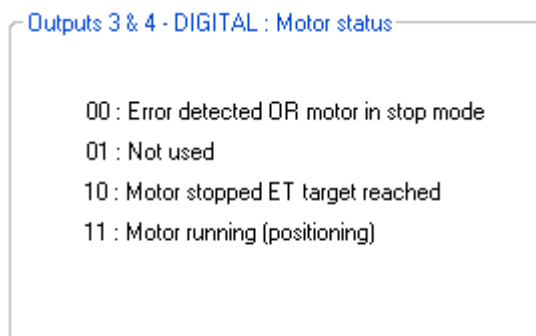
**Figure 327**

State of digital output 2 "Real direction": Used to find out the motor direction of rotation.



**Figure 328**

Combinations of digital outputs 3 & 4 "Motor status": Used to find out the motor status.



**Figure 329**

12.2.9.9. "Tuning" Tab Parameters

Selection of the various parameters to be represented in graphic form: either 1, 2, 3 or 4 parameters. The system position response (measurement vs setpoint) can therefore be compared while displaying changes in the current and the speed.

- Real speed
- real torque
- Current position
- Position setpoint

**Figure 330**

Set the PID controller factors in the position control loop (this function is reserved for advanced users). The values given in the example below ensure correct product operation in the majority of cases.

Position control loop parameters

Kp = <input style="width: 80%;" type="text" value="0.50000"/>	Ki = <input style="width: 80%;" type="text" value="0.00600"/>
Kd = <input style="width: 80%;" type="text" value="3.00000"/>	

**Figure 331**

It is possible to set the recording time you wish to view, from 1 to 300 seconds. The sampling interval is 10 ms. During data acquisition, the other HMI functions are not available.

Recording time :  Second(s)

**Figure 332**

"Curve Drawing" button: used to start data acquisition. Curves are only displayed once acquisition is complete.

"Export Data" button: used to retrieve data corresponding to the selected parameters in a text file (.txt). To make this file compatible with the Excel spreadsheet, change its extension to .csv.

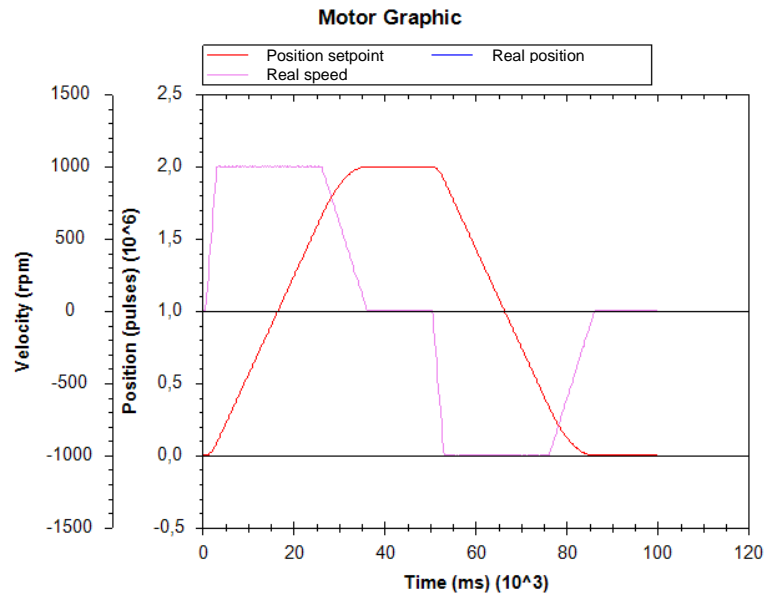
Curve Drawing

Export Data

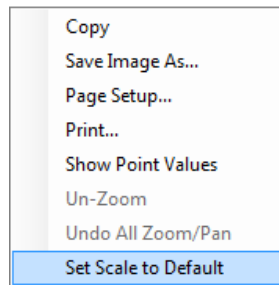
**Figure 333**

Example:

- Application total stroke length = 2000000 pulses
- Speed profile: speed = 1000 rpm / acceleration = 400 rpm/sec / deceleration = 100 rpm/sec
- The following results were obtained :




**NB:** The display scales can be changed with the mouse wheel. Other functions are available by right-clicking the mouse.



**Figure 334**

12.2.9.10. "Limits" Tab Parameters

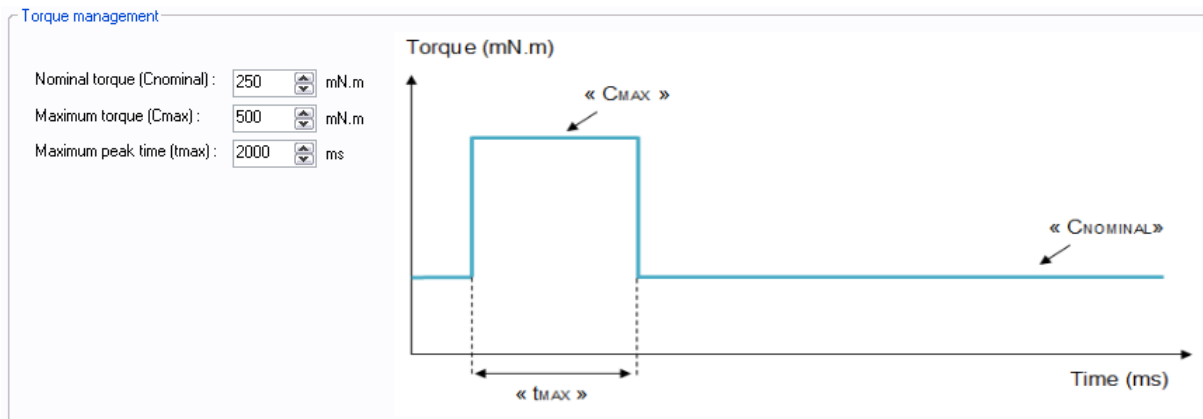
 **WARNING**

**UNEXPECTED MOVEMENT**  
An inappropriate setting for the torque values can result in unexpected movements of the application and destruction of the motor.

- Make sure this will not cause any damage.
- Do not continue with the test if there is anyone or any obstacle in the hazardous zone.


**Failure to comply with these precautions will result in death, serious injury or equipment damage.**

This tab can be used to set the limit values for various parameters.



**Figure 335**

Setting the various torque parameters: When the application torque exceeds the torque " $C_{NOMINAL}$ ", the motor can provide torque up to the value " $C_{MAX}$ " for the maximum duration " $t_{MAX}$ ". Thereafter, if the application torque is still higher than " $C_{NOMINAL}$ ", the motor torque is limited to the value " $C_{NOMINAL}$ " until the application torque falls back below this value.

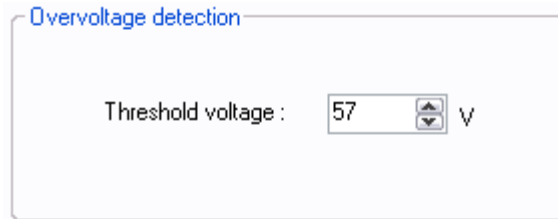
 **WARNING**

**VOLTAGE SURGES**  
During the braking phases, the motor generates voltage surges.

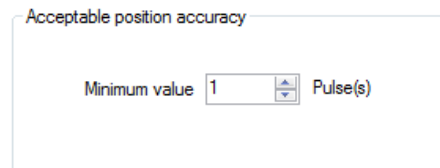
- Check that its voltage surges can be tolerated by the other devices connected to the same power supply.
- Use an external circuit to limit voltage surges if the brake is being used intensively.

**Failure to comply with these precautions will result in death, serious injury or equipment damage.**

Setting the overvoltage detection threshold parameters: If the voltage at the motor terminals exceeds this threshold, an error is generated, the motor is stopped and no holding torque is applied (freewheeling).

**Figure 336**

Setting of the « Acceptable position accuracy » for the position to reach : This value gives the acceptable tolerance to consider that the target position is reached. The output « target reached » will become active when motor position will be at the position [targeted position +/- the « Acceptable position accuracy »].

**Figure 337**

### 12.2.9.11. "Errors" Tab Parameters

Setting the parameters for the action to be taken when an over-torque error is encountered: real torque higher than the nominal torque "C<sub>NOMINAL</sub>" for a time longer than "t<sub>MAX</sub>" (in option).

84 - Over Torque Error

The torque limitation is exceeded

Motor stopped, no holding torque applied  
 Motor stopped, holding torque applied 150 mN.m  
 The motor tries to reach its input setpoint

**Figure 338**

For all errors affecting motor safety, the action to be taken cannot be configured: in the event of an error, the motor is stopped and no holding torque is applied (freewheeling).

Motor safety errors

81 - Overtemperature (>110°C)	➔	Motor stopped, no holding torque applied
82 - Undervoltage (<8V)	➔	Motor stopped, no holding torque applied
83 - Overvoltage(>57V)	➔	Motor stopped, no holding torque applied
85 - Homing Error	➔	Motor stopped, no holding torque applied

**Figure 339**

Setting of the action to perform when a target error is detected : (not available, optional only)

When motor is not able to achieve in the required time limit its position target +/- the "Acceptable position accuracy », the "Position target error" is activated and the selected action will occur.

86 - Position target error

Position target error : Target not reached in time 2000 ms

Motor stopped, no holding torque applied  
 Motor stopped, holding torque applied 150 mN.m  
 The motor tries to reach its input setpoint

**Figure 340**

Procedure for restarting the motor following detection of an error:

- Eliminate the cause of the fault.
- Switch to stop mode: Inhibit inputs 1 and 2 (IN1 = IN2 = 0) to be in the « stop and erase error » mode.
- Go back to a running mode in activating input 1 or 2 or the both.



## 12.2.10. Expert Program P202


### 12.2.10.1. Description

P202 expert program allows to:

- Perform a homing phase to initialize the system with detection of the stroke ends (mechanical stop or switch limit).
- Define a position setpoint in using two 0/10V analog inputs: One for coarse tuning and second for thin tuning. The total stroke (which has to be set per the user in this program) can be cut up to 65536 positions.
- Memorize the new position setpoint
- Go to the new position target
- Select a speed profile (choice between 2 profiles) to go from a position to another position. A speed profile contains acceleration, deceleration and maximum allowed speed values.

### 12.2.10.2. "Homing" Tab Parameters

Set the polarity of the switch wired on digital input "In3":



Switch Status

High state active     Low state active

**Figure 341**

Set the difference in position (in pulses) between the mechanical stops and the application total stroke limits: stop 1 (END1) represents the stroke start, stop 2 (END2) represents the stroke end.

Note: Where there is only one mechanical stop, the "Offset 2" parameter is not available.



Offset (pulses)

Offset 1 1000    Offset 2 1000

**Figure 342**

Set the search speed for stops during the homing phase.



Homing Speed

100 rpm

**Figure 343**

Set the homing torque that allows the mechanical stop to be found by detection of overtorque.

Homing Torque

  mN.m**Figure\_344**

Set the maximum permitted time for the homing phase. If this value is exceeded, an error will be generated. Time limited to 300 s.

Max Homing Time

  second**Figure\_345**

Set the direction of rotation for the first stop search.

N.B.: By default, the motor runs forward (CW).

Direction of rotation

 Change the direction of rotation**Figure\_346**

### 12.2.10.3. "Inputs" Tab Parameters

Combinations of digital inputs 1 and 2: Used to choose the motion to be performed from the 4 actions indicated below.

Input 1 and 2 - Digital: move selection		
I1	I2	
<input type="checkbox"/> 0	<input type="checkbox"/> 0	Stop and error cancelation
<input type="checkbox"/> 1	<input type="checkbox"/> 0	Do homing phase
<input type="checkbox"/> 0	<input type="checkbox"/> 1	Validate and memorize new requested position
<input type="checkbox"/> 1	<input type="checkbox"/> 1	Go to memorized position

**Figure 347**

Information concerning the polarity of the switch wired on digital input 3. This polarity is selected in the "Homing" tab (see above).

Input 3 - DIGITAL - Switch	
<input checked="" type="radio"/>	High state active
<input type="radio"/>	Low state active

**Figure 348**

Digital input 4 - IN4 : Used to select one of the two speed profile.

To go from a position to a new position, motor follows a trapezoidal trajectory. This trajectory uses the maximum speed, acceleration and deceleration which are set in the « Digital speed profile selection » zone.

Input 4 - Digital: speed profile selection			
	Speed (rpm)	Acceleration (rpm/s)	Deceleration (rpm/s)
Profile 1:	<input type="text" value="500"/>	<input type="text" value="50"/>	<input type="text" value="50"/>
Profile 2:	<input type="text" value="2500"/>	<input type="text" value="1000"/>	<input type="text" value="1000"/>

**Figure 349**

Note : If the user needs to change its velocity profile during a positioning phase, it is strongly recommended to use the same deceleration slope for both velocity profiles to avoid overruns targets.

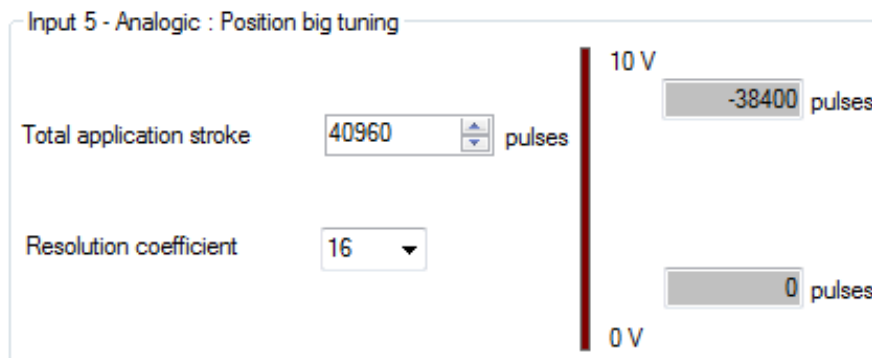
Input IN5 and IN6 setpoints: To do the position setting using the two 0-10V analog inputs.

Parameter « total stroke length » is the number of encoder pulses corresponding to the stroke when IN5 and IN6 are at 10V.

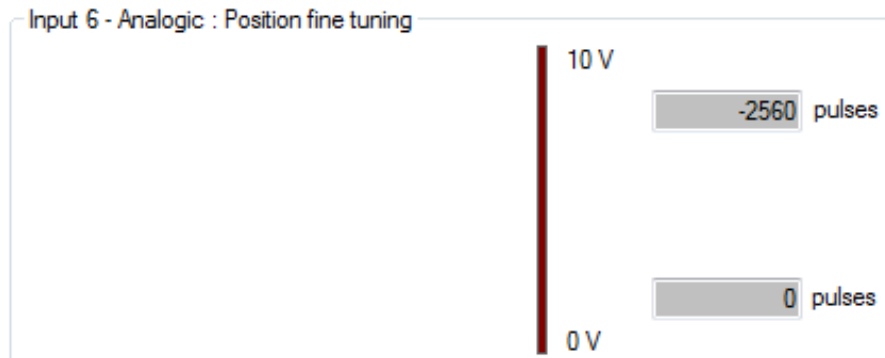
Parameter “resolution coefficient” allows to cut the « total stroke length » in 2,048 or 4,096 or 8,192 or 16,384 or 32,768 or 65,536 positions.

The distribution of the « Total stroke length » on the two analog setpoint inputs is carried out according to the rules below.

- On IN5 :  $[0 - 10V] \equiv [0 ; Stroke_{totale\_application} \times \frac{Coefficient\_resolution - 1}{Coefficient\_resolution}]$  coded on 1024 points (coarse setting)
- On IN6 :  $[0 - 10V] \equiv [0 ; Stroke_{totale\_application} \times \frac{1}{Coefficient\_résolution}]$  coded on 1024 points (thin setting)



**Figure 350**



**Figure 351**

The motor position setpoint is the addition of position setpoint of IN5 and of position setpoint of IN6.

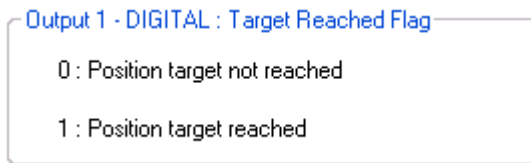
In above example :

- On IN5 :  $[0 - 10V] \equiv [0 ; 40960 \times \frac{16-1}{16}] = [0 ; 38400]$  coded on 1,024 points (coarse setting)
- On IN6 :  $[0 - 10V] \equiv [0 ; 40960 \times \frac{1}{16}] = [0 ; 2560]$  coded on 1,024 points (thin setting)

Note : The sign (-) at the 10V setpoint depends from the direction of rotation during the homing sequence.

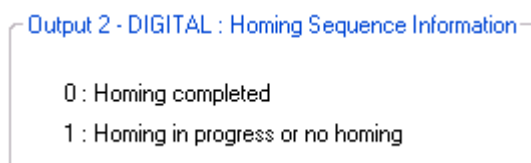
#### 12.2.10.4. Type 5 "Outputs" Tab Parameters

State of digital output 1 "Target Reached Flag": Used to find out whether the position setpoint has been reached.



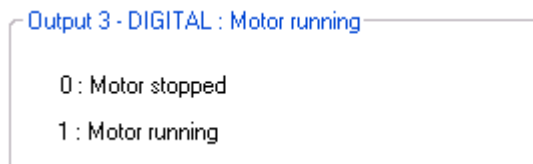
**Figure 352**

State of digital output 2 "Homing Sequence Information": Used to find out how the homing phase is progressing: completed, in progress or not performed.



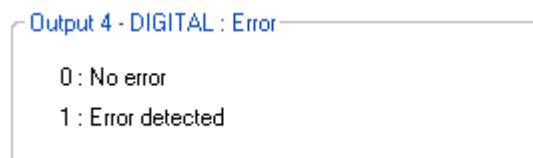
**Figure 353**

State of digital output 3 "Motor running": Used to find out whether the motor is stopped or running.



**Figure 354**

State of digital output 4 "Error": Used to find out whether an error has been detected.



**Figure 355**

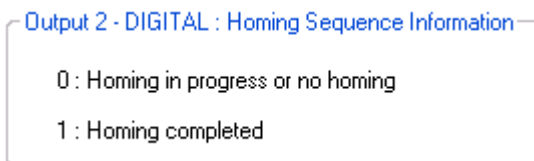
### 12.2.10.5. Type 6 "Outputs" Tab Parameters

State of digital output 1 "Target Reached Flag": Used to find out whether the position setpoint has been reached.



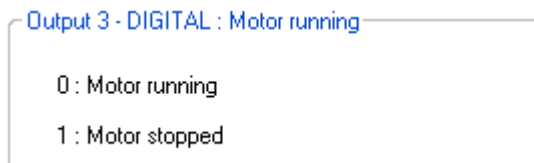
**Figure 356**

State of digital output 2 "Homing Sequence Information": Used to find out how the homing phase is progressing: completed, in progress or not performed.



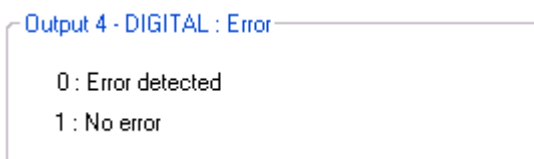
**Figure 357**

State of digital output 3 "Motor running": Used to find out whether the motor is stopped or running.



**Figure 358**

State of digital output 4 "Error": Used to find out whether an error has been detected.



**Figure 359**

## 12.2.10.6. Type 7 "Outputs" Tab Parameters

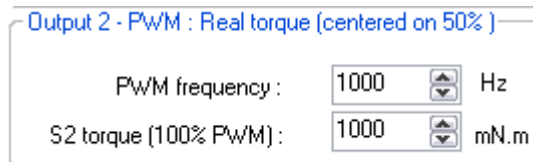
State of digital output 1 "Target Reached Flag": Used to find out whether the position setpoint has been reached.



**Figure 360**

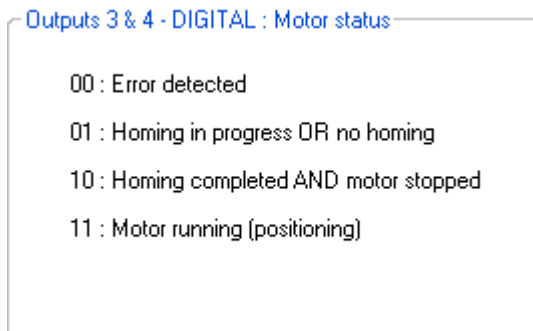
Setting the parameters of PWM output 2 "Real torque (centered on 50%)": The parameters can be set for the signal frequency of this output and the torque value corresponding to a cyclical ratio of 100% (scaling).

- If cyclical ratio = 0% → Braking torque supplied = "S2 torque".
- If cyclical ratio = 50% → Torque supplied = 0 mNm.
- If cyclical ratio = 100% → Motor torque supplied = "S2 torque".



**Figure 361**

Combinations of digital outputs 3 & 4 "Motor status": Used to find out the motor status.



**Figure 362**

12.2.10.7. Type 8 "Outputs" Tab Parameters

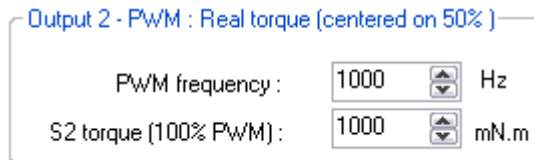
State of digital output 1 "Target Reached Flag": Used to find out whether the position setpoint has been reached.



**Figure 363**

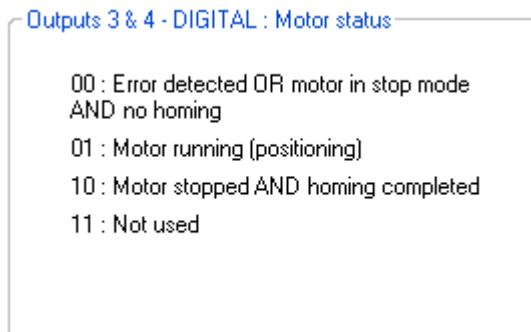
Setting the parameters of PWM output 2 "Real torque (centered on 50%)": The parameters can be set for the signal frequency of this output and the torque value corresponding to a cyclical ratio of 100% (scaling).

- If cyclical ratio = 0% → Braking torque supplied = "S2 torque".
- If cyclical ratio = 50% → Torque supplied = 0 mNm.
- If cyclical ratio = 100% → Motor torque supplied = "S2 torque".



**Figure 364**

Combinations of digital outputs 3 & 4 "Motor status": Used to find out the motor status.



**Figure 365**



### 12.2.10.8. Type 9 "Outputs" Tab Parameters

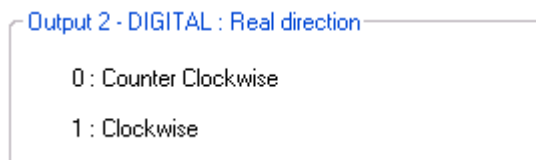
Setting the parameters of Pulse output 1 "Real speed": A Hall pulse with configurable width (100 to 800  $\mu$ s) is generated each time one of the 3 motor Hall sensors changes state.

80140\_SMi21 and 80180\_SMi21 motors have 12 Hall pulses per revolution (2 pairs of poles).  
The 80280\_SMi21 motor has 24 Hall pulses per revolution (4 pairs of poles).



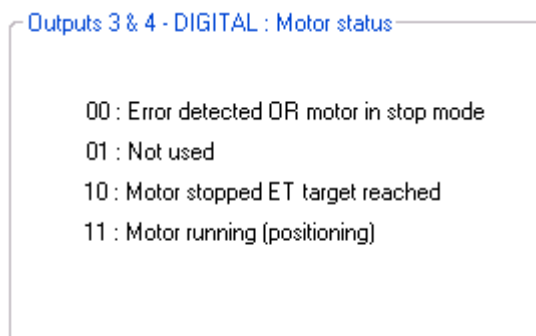
**Figure\_366**

State of digital output 2 "Real direction": Used to find out the motor direction of rotation.



**Figure\_367**

Combinations of digital outputs 3 & 4 "Motor status": Used to find out the motor status.



**Figure\_368**

12.2.10.9. "Tuning" Tab Parameters

Selection of the various parameters to be represented in graphic form: either 1, 2, 3 or 4 parameters. The system position response (measurement vs setpoint) can therefore be compared while displaying changes in the current and the speed.

- Real speed
- real torque
- Current position
- Position setpoint

**Figure 369**

Set the PID controller factors in the position control loop (this function is reserved for advanced users). The values given in the example below ensure correct product operation in the majority of cases.

Position control loop parameters

Kp =       Ki =

Kd =

**Figure 370**

It is possible to set the recording time you wish to view, from 1 to 300 seconds. The sampling interval is 10 ms. During data acquisition, the other HMI functions are not available.

Recording time :  Second(s)

---

**Figure 371**

"Curve Drawing" button: used to start data acquisition. Curves are only displayed once acquisition is complete.

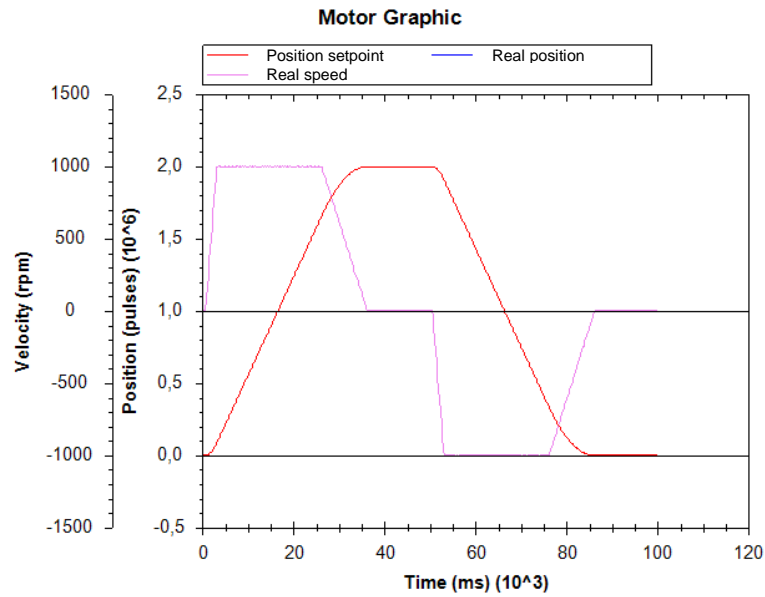
"Export Data" button: used to retrieve data corresponding to the selected parameters in a text file (.txt). To make this file compatible with the Excel spreadsheet, change its extension to .csv.

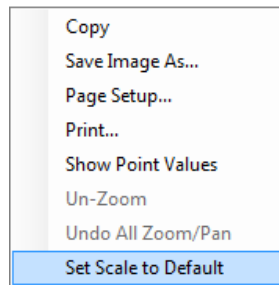
**Figure 372**

Example:

- Application total stroke length = 2000000 pulses
- Speed profile: speed = 1000 rpm / acceleration = 400 rpm/sec / deceleration = 100 rpm/sec
- The following results were obtained :




Note: The display scales can be changed with the mouse wheel. Other functions are available by right-clicking the mouse.



**Figure 373**

12.2.10.10. "Limits" Tab Parameters

 **WARNING**

**UNEXPECTED MOVEMENT**  
 An inappropriate setting for the torque values can result in unexpected movements of the application and destruction of the motor.

- Make sure this will not cause any damage.
- Do not continue with the test if there is anyone or any obstacle in the hazardous zone.

**Failure to comply with these precautions will result in death, serious injury or equipment damage.**

This tab can be used to set the limit values for various parameters.

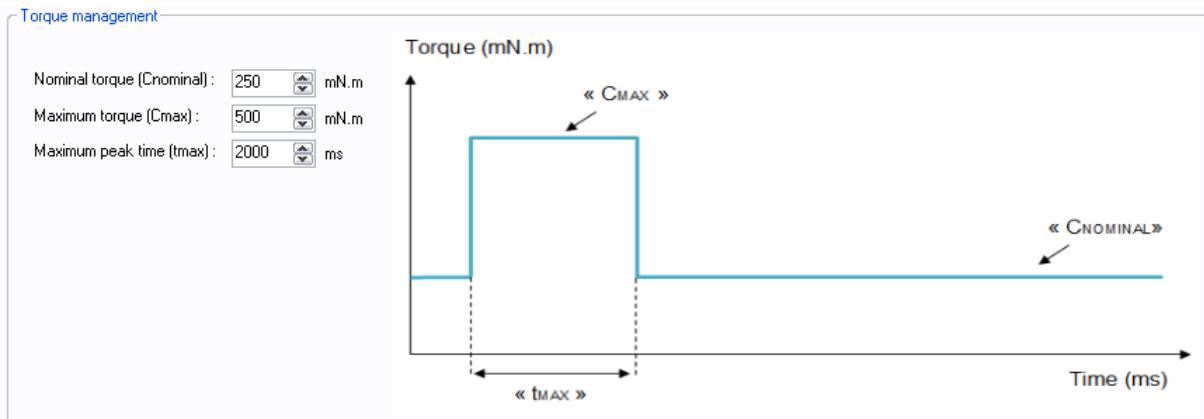



Figure 374

Setting the various torque parameters: When the application torque exceeds the torque "C<sub>NOMINAL</sub>", the motor can provide torque up to the value "C<sub>MAX</sub>" for the maximum duration "t<sub>MAX</sub>". Thereafter, if the application torque is still higher than "C<sub>NOMINAL</sub>", the motor torque is limited to the value "C<sub>NOMINAL</sub>" until the application torque falls back below this value.

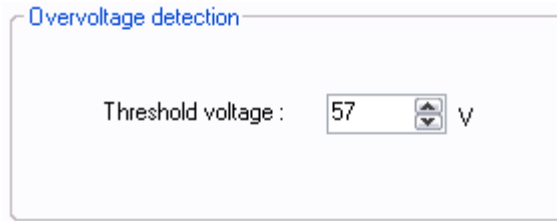
 **WARNING**

**VOLTAGE SURGES**  
 During the braking phases, the motor generates voltage surges.

- Check that its voltage surges can be tolerated by the other devices connected to the same power supply.
- Use an external circuit to limit voltage surges if the brake is being used intensively.

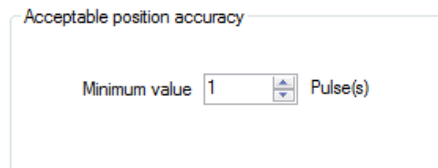
**Failure to comply with these precautions will result in death, serious injury or equipment damage.**

Setting the overvoltage detection threshold parameters: If the voltage at the motor terminals exceeds this threshold, an error is generated, the motor is stopped and no holding torque is applied (freewheeling).



**Figure 375**

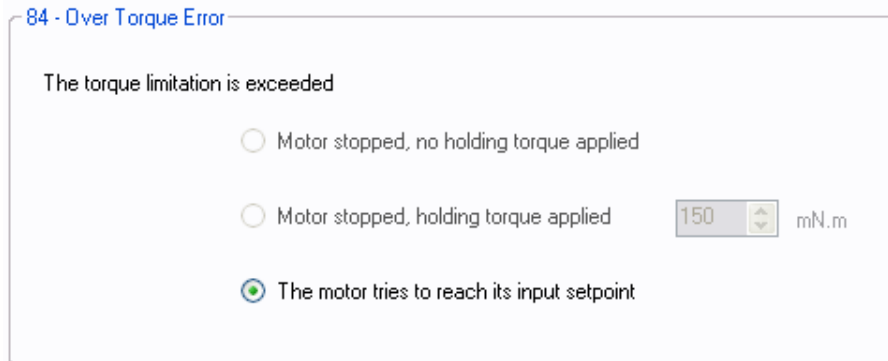
Setting of the « Acceptable position accuracy » for the position to reach : This value gives the acceptable tolerance to consider that the target position is reached. The output « target reached » will become active when motor position will be at the position [targeted position +/- the « Acceptable position accuracy »].



**Figure 376**

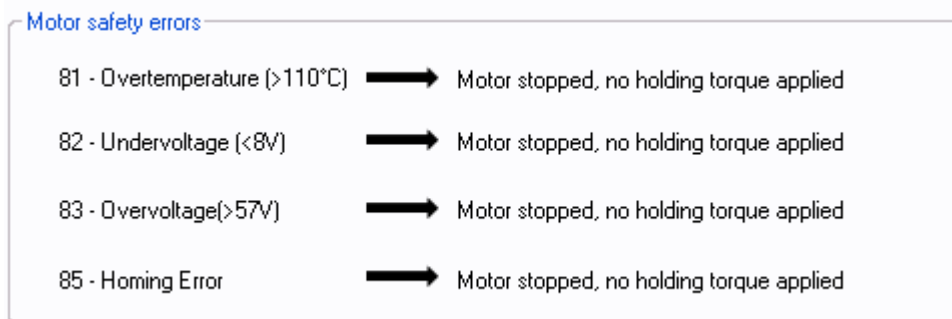
12.2.10.11. "Errors" Tab Parameters

Setting the parameters for the action to be taken when an over-torque error is encountered: real torque higher than the nominal torque "C<sub>NOMINAL</sub>" for a time longer than "t<sub>MAX</sub>" (in option).



**Figure 377**

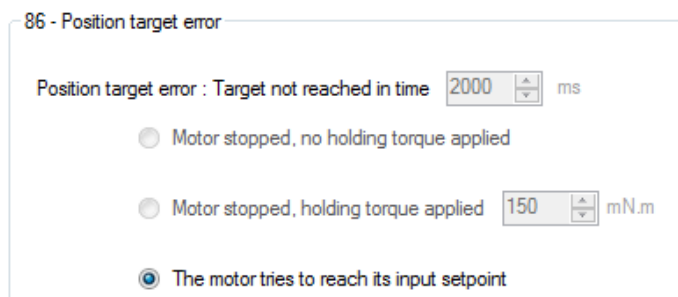
For all errors affecting motor safety, the action to be taken cannot be configured: in the event of an error, the motor is stopped and no holding torque is applied (freewheeling).



**Figure 378**

Setting of the action to perform when a target error is detected : (not available, optional only)

When motor is not able to achieve in the required time limit its position target +/- the "Acceptable position accuracy », the "Position target error" is activated and the selected action will occur.



**Figure 379**

Procedure for restarting the motor following detection of an error:

- Eliminate the cause of the fault.
- Switch to stop mode: Inhibit inputs 1 and 2 (IN1 = IN2 = 0) to be in the « stop and erase error » mode.
- Go back to a running mode in activating input 1 or 2 or the both.




### 12.3. Torque Programs

#### 12.3.1. Types of Inputs in C100 Programs

The table below defines the function associated with each of the inputs in the 2 C100 programs (the color associated with the input number corresponds to that of the I/O bundle):

Inputs	Programs	
	C101	C102
In1	ON/OFF	000 : "In6" torque setpoint 001 : Priority torque 1 010 : Priority torque 2 100 : Priority torque 3
In2	Direction	
In3	Not used	
In4	Fast stop	00 : Fast stop 10 : CCW 01 : CW 11 : Stop, disable error
In5	Torque ramp	
In6	Torque	Torque (if In1 = In2 = In3 = 0)

**Key:**



	Digital type input
	Analog or PWM type input
	Forthcoming programs

#### 12.3.2. Types of Outputs in C100 Programs

For all expert torque programs, we have 2 configurable output configurations (the color associated with the output number corresponds to that of the I/O bundle):

	Out1	Out2	Out3	Out4
Type 2	Real speed <i>PWM</i>	Real torque <i>PWM</i>	Motor running <i>Digital</i>	Error <i>Digital</i>
Type 10	Real speed (centered on 50%) <i>PWM</i>	Real torque (centered on 50%) <i>PWM</i>	00 : error detected 01 : motor running 10 : motor stopped, torque position reached and held 11 : motor stopped, no torque applied <i>Digital combinations</i>	

**Key:**

	Digital type output
	PWM/Pulse/Frequency type output

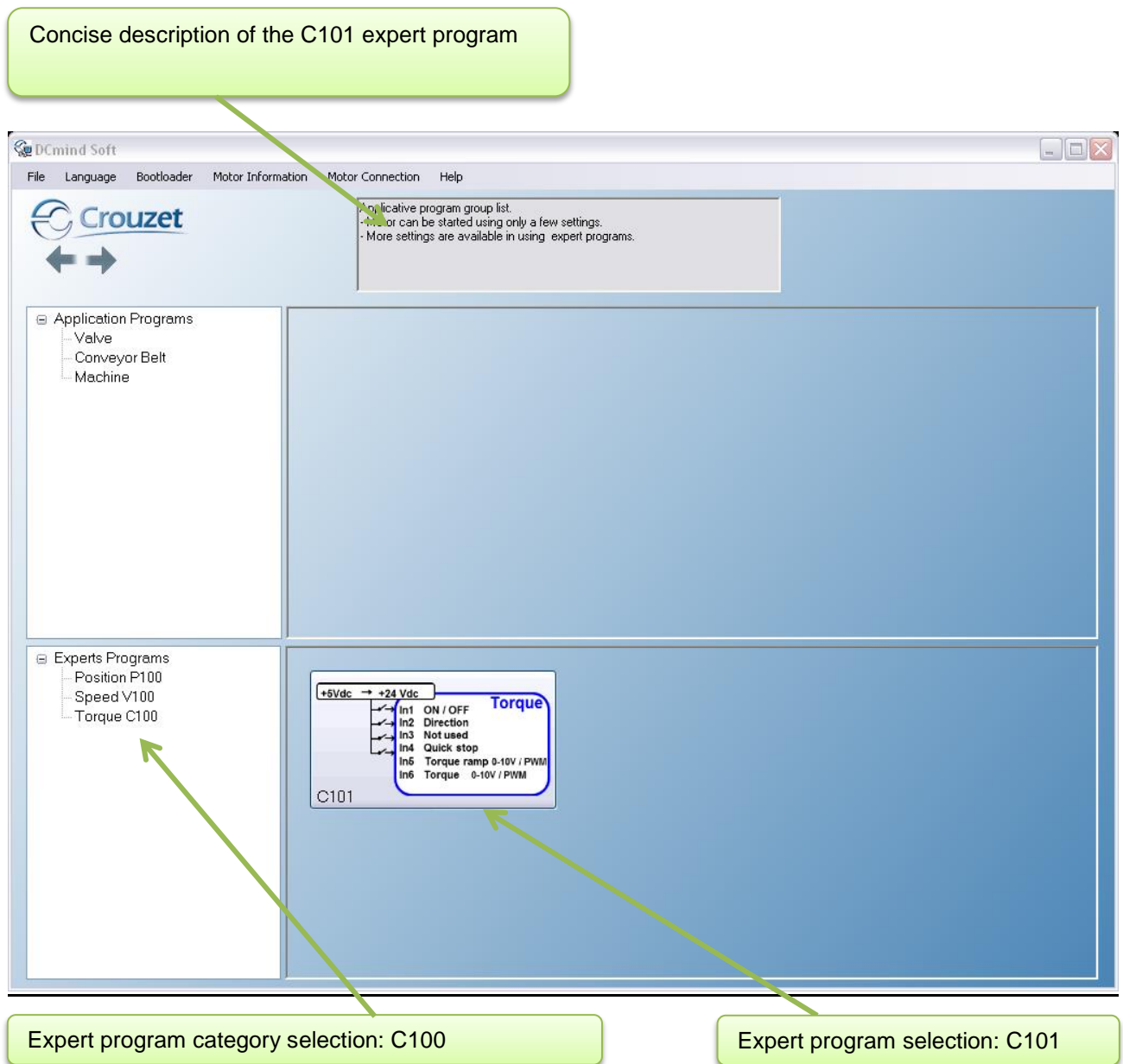
### 12.3.3. Description of the Various Tabs

For the description of tabs, expert program C101 is used as an example (for detailed information about each torque expert program, see the "Expert Program C101" section in this document).

#### 12.3.3.1. Home Page

This page is common to all the expert and application programs, whether in speed, position or torque mode. It can be used to choose between the various types of application and expert programs.

In our example, we have chosen the "Torque C100" category in the "Expert Programs" group, so the icons for the various C100 expert programs appear in the bottom right-hand corner of the window, and you then need to click on the one corresponding to the "C101" expert program:



**Figure 380**



### 12.3.3.2. "Description" Tab

This is an information tab containing a concise description of the various torque profiles that are created using this expert mode:

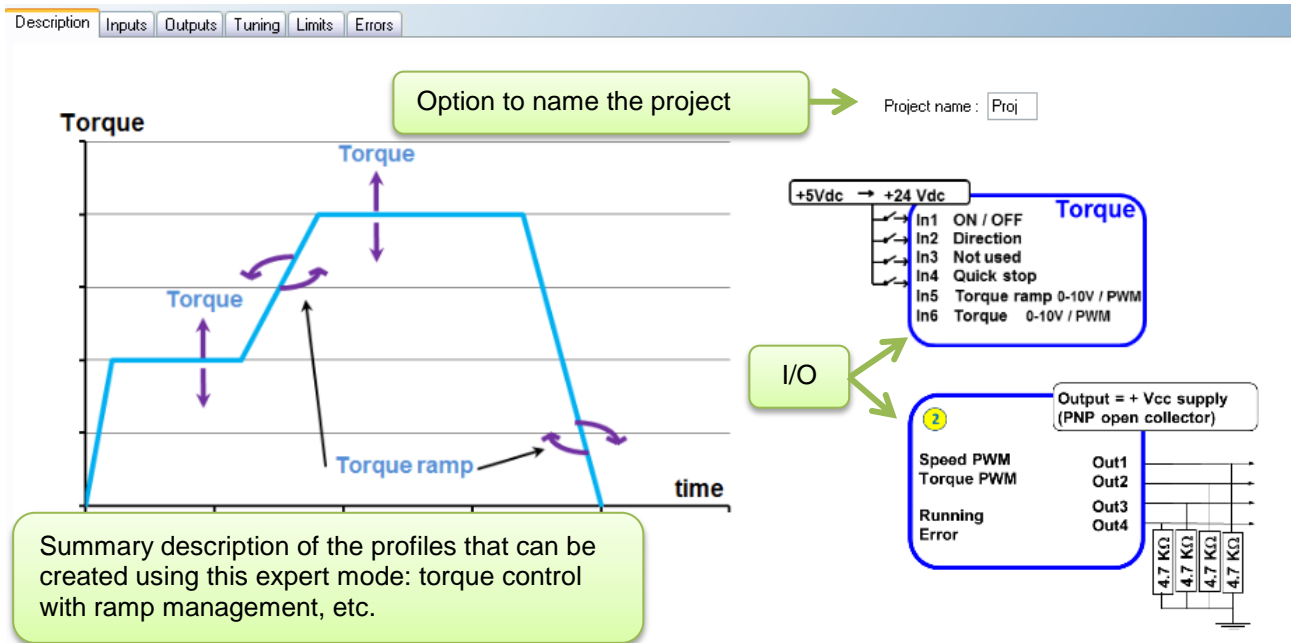


Figure 381

### 12.3.3.3. "Inputs" Tab

This tab is used to configure the various inputs in this expert mode (digital input polarity, value, control type, maximum and minimum control limit, etc.):

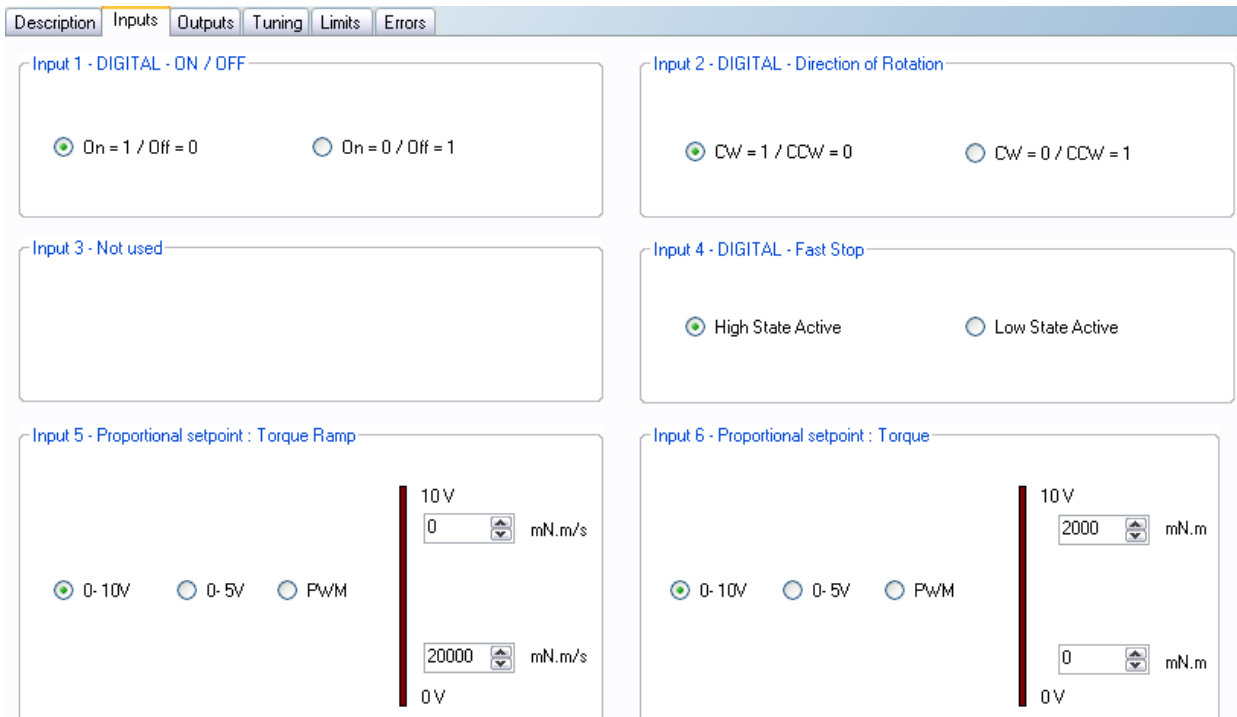


Figure 382

### 12.3.3.4. "Outputs" Tab

This tab is used to select and configure the various outputs in this expert mode (torque type 2 and type 10):

**Figure 383**

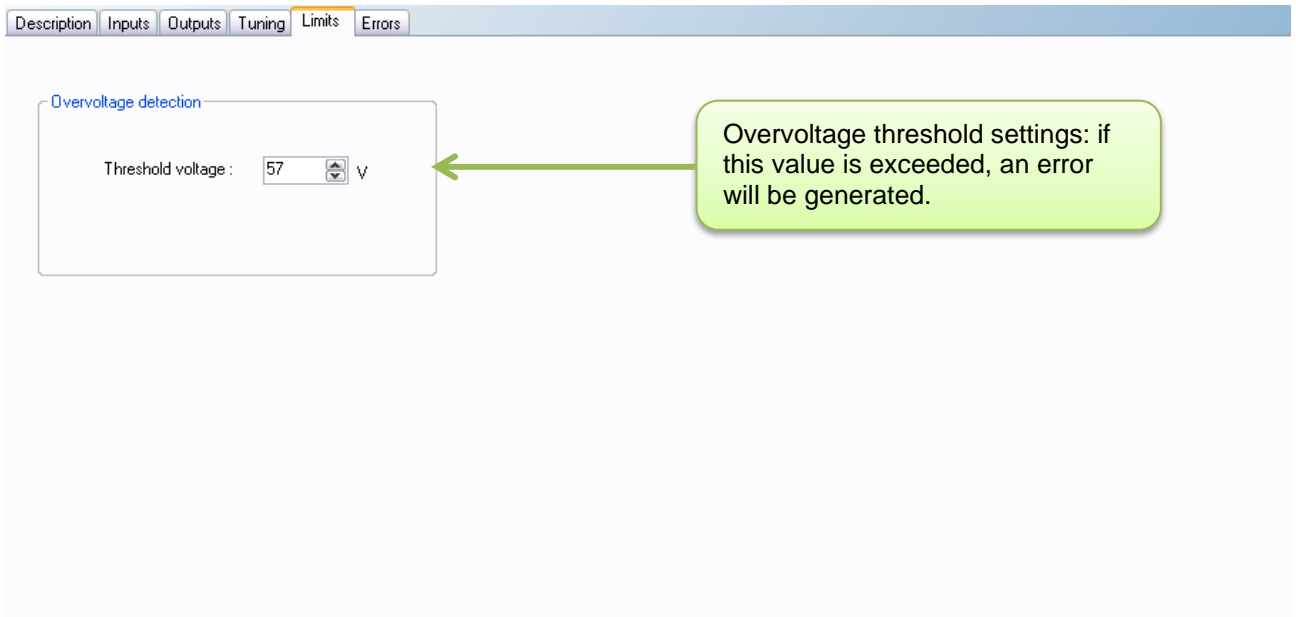
### 12.3.3.5. "Tuning" Tab

This tab is used to represent some parameters (speed, torque, etc.) in graphic form and modify the torque control loop coefficients. It is common to all the torque expert programs.

**Figure 384**

### 12.3.3.6. "Limits" Tab

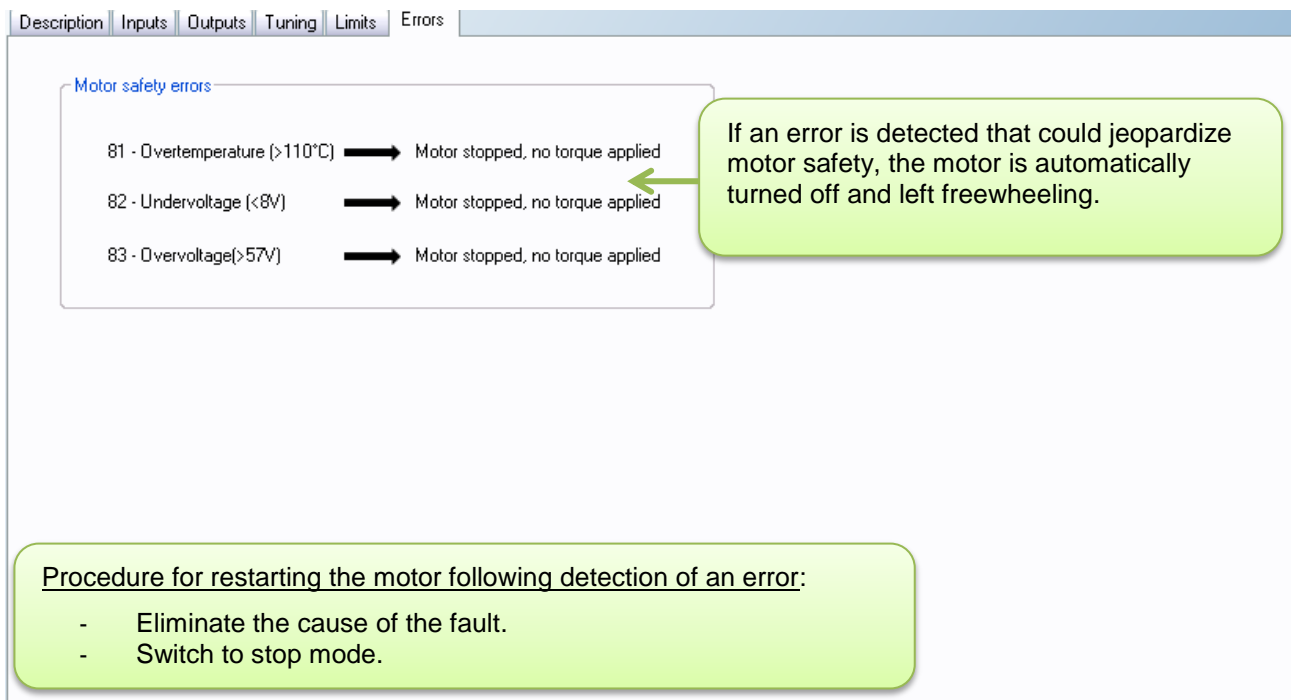
This tab can be used to set the power supply overvoltage threshold.



**Figure 385**

### 12.3.3.7. "Errors" Tab

This tab provides information about the type of error encountered (based on the error code) and the action to be taken by the motor following this error.



**Figure 386**

### 12.3.4. Expert Program C101

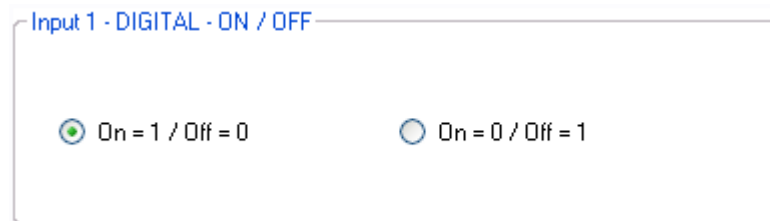
#### 12.3.4.1. Description

Expert program C101 is used to:

- Create torque profiles with analog or PWM control.
- Set the torque up and down ramps with analog or PWM control.

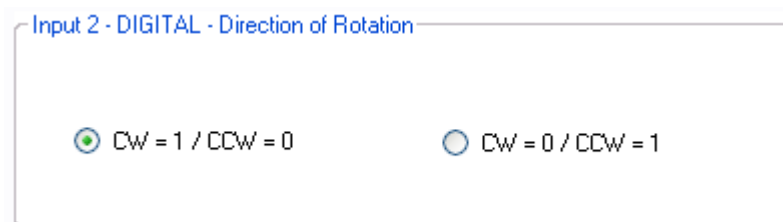
#### 12.3.4.2. "Inputs" Tab Parameters

Digital input 1: Used to set the "On/Off" input polarity.



**Figure 387**

Digital input 2: Used to set the "Direction of Rotation" input polarity.

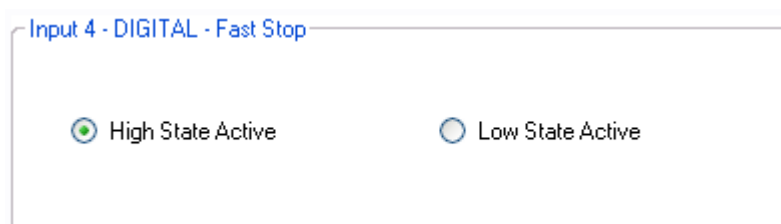


**Figure 388**

Digital input 3: Not used

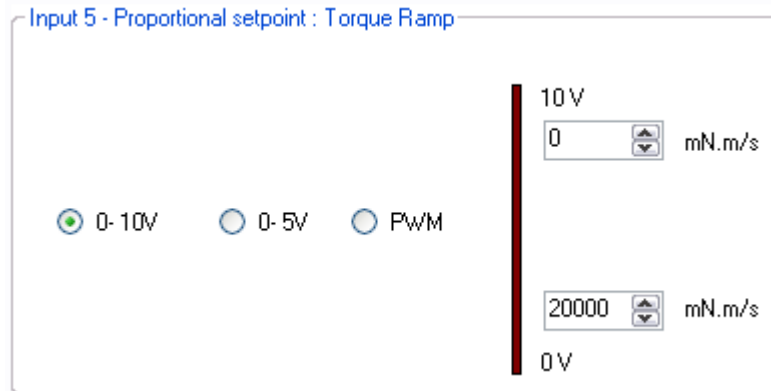
Digital input 4: Used to set the "Fast stop" input polarity.

This input is used to stop the motor as quickly as possible, ignoring the setpoints applied to the other inputs.



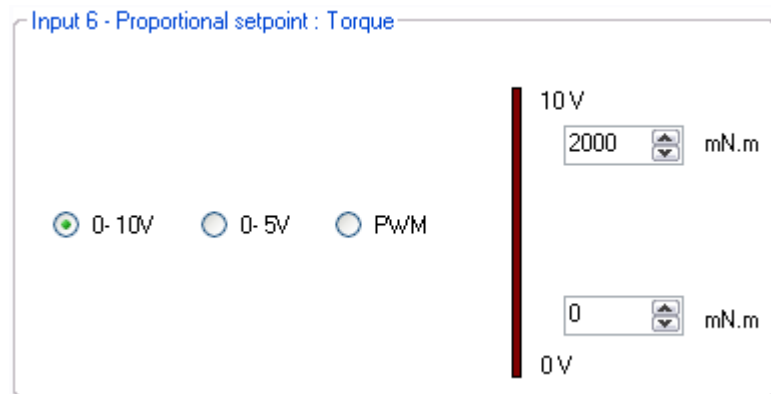
**Figure 389**

Setpoint input 5: Used to select the control type for the torque ramp setpoint and fix the maximum and minimum limits for this setpoint. An inverted scale can be used.



**Figure\_390**

Setpoint input 6: Used to select the control type for the torque setpoint and fix the maximum and minimum limits for this setpoint. An inverted scale can be used.

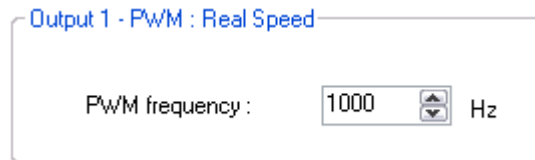


**Figure\_391**

### 12.3.4.3. Type 2 "Outputs" Tab Parameters

Setting the parameters of PWM output 1 "Real Speed": The parameters can be set for the signal frequency of this output (must be identical to the one for PWM output 2).

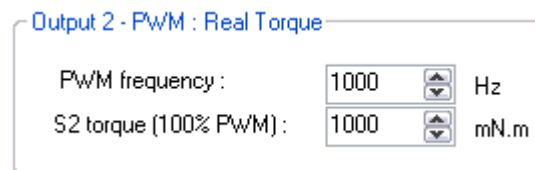
- If cyclical ratio = 0% → Real speed = 0 rpm.
- If cyclical ratio = 100% → Real speed = maximum speed setpoint defined in In6.



**Figure\_392**

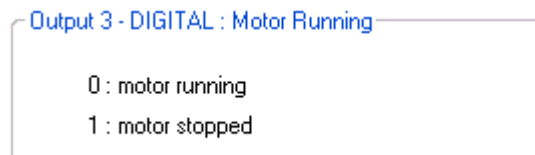
Setting the parameters of PWM output 2 "Real Torque": The parameters can be set for the signal frequency of this output (must be identical to the one for PWM output 1) and the torque value corresponding to a cyclical ratio of 100% (scaling).

- If cyclical ratio = 0% → Torque supplied = 0 mNm.
- If cyclical ratio = 100% → Torque supplied = "S2 torque".



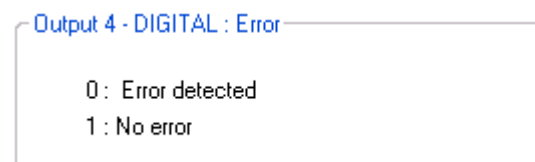
**Figure\_393**

State of digital output 3 "Motor Running": Used to find out whether the motor is stopped or running.



**Figure\_394**

State of digital output 4 "Error": Used to find out whether an error has been detected.

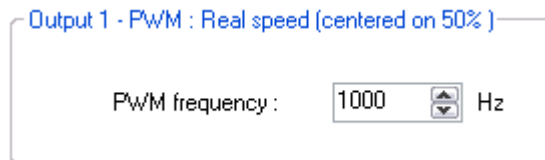


**Figure\_395**

### 12.3.4.4. Type 10 "Outputs" Tab Parameters

Setting the parameters of PWM output 1: "Real speed (centered on 50%)": The parameters can be set for the signal frequency of this output (must be identical to the one for PWM output 2).

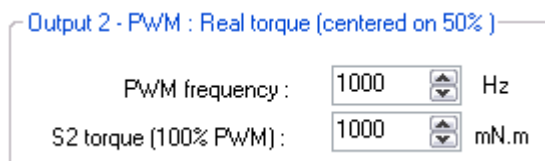
- If cyclical ratio = 0% → Motor running forward (CW) at maximum speed setpoint defined in In6.
- If cyclical ratio = 50% → Real speed = 0 rpm.
- If cyclical ratio = 100% → Motor running in reverse (CCW) at maximum speed setpoint defined in In6.



**Figure 396**

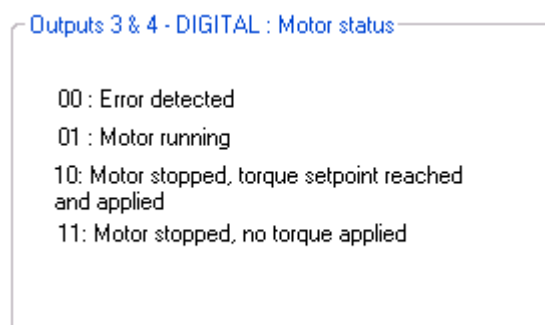
Setting the parameters of PWM output 2 "Real torque (centered on 50%)": The parameters can be set for the signal frequency of this output (must be identical to the one for PWM output 1) and the torque value corresponding to a cyclical ratio of 100% (scaling).

- If cyclical ratio = 0% → Braking torque supplied = "S2 torque".
- If cyclical ratio = 50% → Torque supplied = 0 mNm.
- If cyclical ratio = 100% → Motor torque supplied = "S2 torque".



**Figure 397**

Combinations of digital outputs 3 & 4 "Motor status": Used to find out the motor status.



**Figure 398**

### 12.3.4.5. "Tuning" Tab Parameters

Selection of the various parameters to be represented in graphic form: either 1, 2 or 3 parameters. The system torque response (measurement vs setpoint) can therefore be compared while displaying changes in the speed.

- Real Speed
- Real Torque
- Torque Setpoint

**Figure 399**

Set the PID controller factors in the torque control loop (this function is reserved for advanced users). The values given in the example below ensure correct product operation in the majority of cases.

Torque control loop parameters

Kp =       Ki =

Kd =

**Figure 400**

It is possible to set the recording time you wish to view, from 1 to 300 seconds. The sampling interval is 10 ms. During data acquisition, the other HMI functions are not available.

Recording time :  Second(s)

**Figure 401**

"Curve Drawing" button: used to start data acquisition. Curves are only displayed once acquisition is complete.

"Export Data" button: used to retrieve data corresponding to the selected parameters in a text file (.txt). To make this file compatible with the Excel spreadsheet, change its extension to .csv.

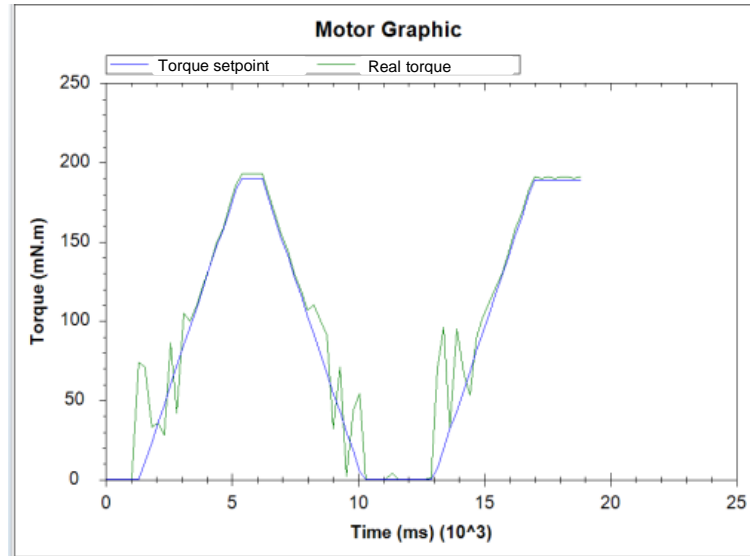
Curve Drawing

Export Data

**Figure 402**

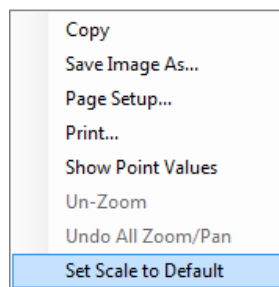


Example: With a torque setpoint on input 6 at 200 mN.m and a torque ramp setpoint on input 5 at 50 mN.m/s, this gives us the following graphic representation (recording time of 20 seconds):




**Figure 403**

Note: The display scales can be changed with the mouse wheel. Other functions are available by right-clicking the mouse.



**Figure 404**

12.3.4.6. "Limits" Tab Parameters

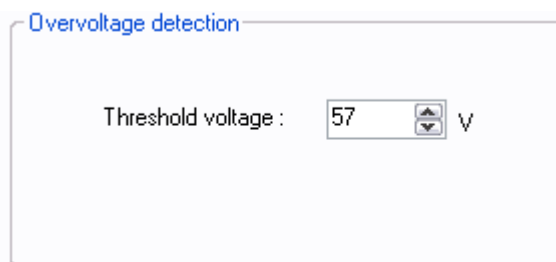
 **WARNING**

**VOLTAGE SURGES**  
 During the braking phases, the motor generates voltage surges.

- Check that its voltage surges can be tolerated by the other devices connected to the same power supply.
- Use an external circuit to limit voltage surges if the brake is being used intensively.

**Failure to comply with these precautions will result in death, serious injury or equipment damage.**

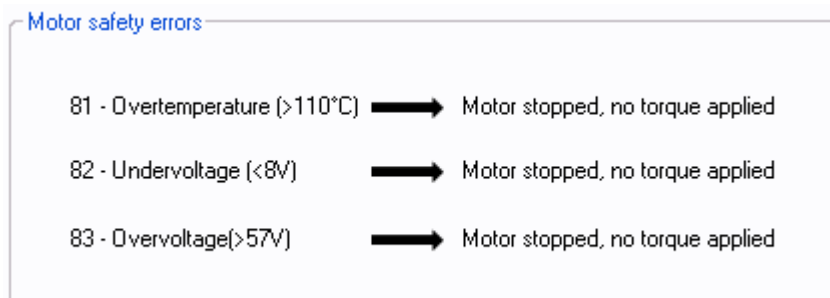
Setting the overvoltage detection threshold parameters: If the voltage at the motor terminals exceeds this threshold, an error is generated, the motor is stopped and no holding torque is applied (freewheeling).



**Figure 405**

12.3.4.7. "Errors" Tab Parameters

For all errors affecting motor safety, the action to be taken cannot be configured: in the event of an error, the motor is stopped and no holding torque is applied (freewheeling).



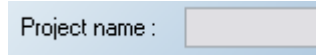
**Figure 406**

Procedure for restarting the motor following detection of an error:

- Eliminate the cause of the fault.
- Switch to stop mode: disable digital input 1 "On/Off".
- Switch back to run mode: enable digital input 1 "On/Off".

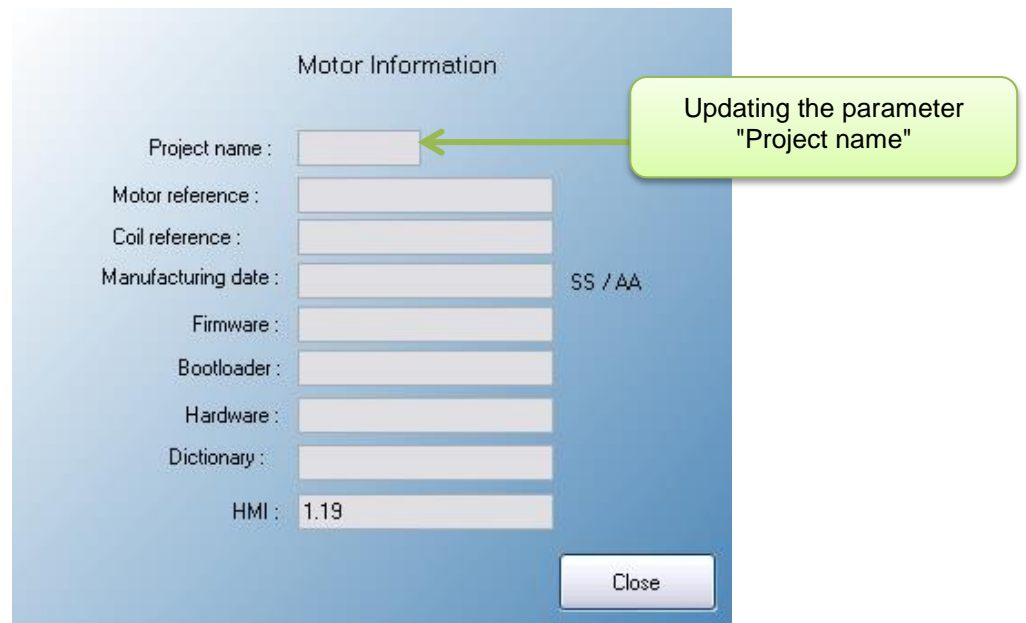
### 13. SAVING PARAMETERS

In all the expert programs (speed, position and torque), the user can give a name to his project (4 alphanumerical characters maximum) using the "Project name" parameter in the program "Description" tab (expert program V101 will be used as an example):



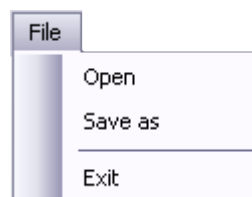
**Figure 407**

The "Project name" parameter can be accessed by clicking the "Motor Information" tab in the main menu bar:



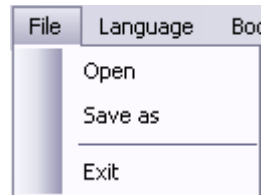
**Figure 408**

The project parameters can be saved in an .xml file by clicking on "**Save As**" in the "File" tab of the main menu.

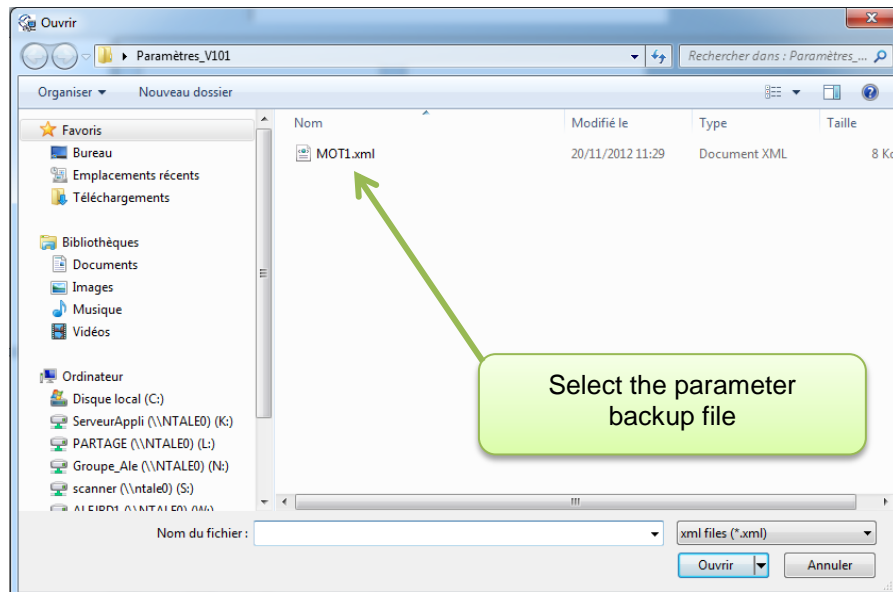


**Figure 409**

They can also be reused by clicking on "**Open**" in the "File" tab of the main menu, then selecting the appropriate "*MOT1.xml*" file.

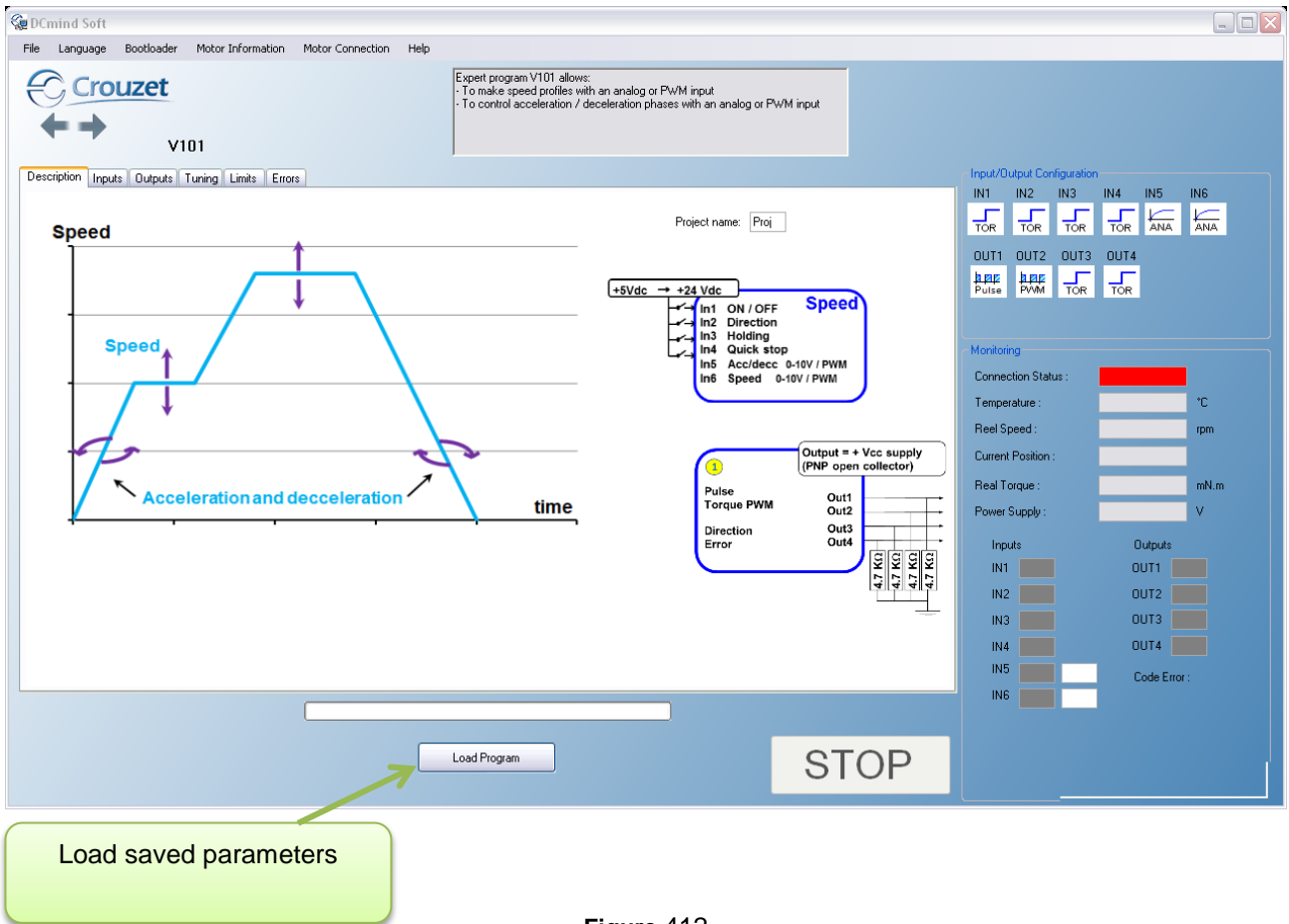


**Figure 410**



**Figure 411**

When the parameter file is uploaded, the HMI automatically launches the associated expert or application program (in our example expert program V101):



**Figure 412**

Press the "Load Program" button to load the "MOT1.xml" file parameters in the motor.

## 14. DIAGNOSTICS AND TROUBLESHOOTING

### 14.1. Mechanical Failures

Error	Cause	Remedy
Significant temperature rise	Overload Holding brake not released	Reduce the load Check control of the holding brake
Whistling or knocking	Faulty bearings	Contact the after-sales service
Friction noise	A rotary transmission device is catching	Align the transmission device
Radial vibration	Transmission device incorrectly aligned Transmission device unbalanced Twisted shaft Resonance in the fixing	Align the transmission device Balance the transmission device Contact the after-sales service Check the rigidity of the motor fixing
Axial vibration	Transmission device incorrectly aligned Transmission device being knocked Resonance in the fixing	Align the transmission device Check the transmission device Check the rigidity of the motor fixing

### 14.2. Electrical Failures

Error	Cause	Remedy
The motor does not start or starts with difficulty	Overload Fault in the connection wires	Reduce the load Check the connection wires Contact the after-sales service
Significant temperature rise in the stator	Overload	Reduce the load
Temperature rise in the connection terminals	Power supply wires disconnected or loose	Tighten the screws

## **15. SERVICE, MAINTENANCE AND DISPOSAL**

### **15.1. Addresses of After-Sales Service Outlets**

Please contact your distributor.

The list of distributors is accessible on the CROUZET Automatismes website [www.crouzet.com](http://www.crouzet.com)

### **15.2. Storage**

The motors must only be transported and stored in dry, dust-free environments that are resistant to vibration. The ambient conditions are stated in the product technical data sheet and must be adhered to.

The storage period is essentially dictated by the stability of the lubricants and should be less than 36 months. To keep the motor in working order, it is advisable to start up the drive solution occasionally.

### **15.3. Maintenance**

Only the manufacturer is authorized to undertake repairs. Any personal intervention voids any guarantee and precludes manufacturer liability.

Repairs cannot be performed with the motor mounted.

**Prior to any intervention on the drive system, please refer to the *Installation and Commissioning* sections to find out what steps to take.**

We recommend that the following operations are done at regular intervals.

*Connections and fixing*

=> Check the connection cables and connections regularly for signs of damage. Replace any damaged cables immediately.

=> Check that all the transmission devices are fully tightened.

=> Retighten all the mechanical and electrical bolted connections to the appropriate tightening torque.



### **WARNING**

#### **UNEXPECTED MOVEMENT**

Exceeding the permissible ambient conditions can allow foreign bodies from the surrounding area to get in and lead to unexpected motor movements or damage to equipment.

- Check the ambient conditions.
- It is vital to avoid fluid stagnation in the shaft bushing.

**Failure to comply with these precautions can result in death, serious injury or damage to equipment.**

*Cleaning*

Clean the motor regularly to remove any dust and dirt. If heat cannot dissipate adequately into the ambient air, this can cause abnormally high temperatures.

The motors are not designed to be cleaned with high-pressure washers. Jet washing can cause water to get inside the motor.

When using cleaning products or solvents, take care not to damage the motor power supply leads and any options (brake), ball bearings and the motor coating.

*Check/run in the holding brake*

*Occasional braking with a shifted load helps conserve the holding brake's holding torque. If the holding brake produces no mechanical work over a prolonged period (braking with a shifted load), some parts of the holding brake can corrode or other deposits can accumulate and thus reduce the holding torque.*

The holding brake has been run in on leaving the factory. If the holding brake produces no mechanical work over a prolonged period, some parts of the holding brake can corrode. If the holding brake should not demonstrate the holding torque specified in the technical specifications, it would need to be run in again:

- => The motor is not mounted. The holding brake is engaged.
- => Measure the brake holding torque using a torque wrench.
- => Compare the value with the holding torque indicated on the technical data sheet.
- => If the holding torque is markedly different from the stated values, turn the motor shaft by hand 25 turns in both directions.
- => Repeat the operation. If the holding torque has not been restored after 3 repeat operations, please contact your vendor.

#### **15.4. Replacing the Motor**

- => Disconnect all the supply voltages. Make sure that no other voltage is applied (safety instructions).
- => Mark all connections and demount the product.
- => Replace it with a motor with the same part number.
- => Install the new product as described in section 4 "Installation".
- => Commission the product as described in section 5 "Commissioning".

#### **15.5. Dispatch, Storage, Disposal**

Comply with the ambient conditions described in the "TECHNICAL SPECIFICATIONS" section.

##### *Dispatch*

Protect the product against shocks during transport.  
Use the original packaging for this purpose.

##### *Storage*

Only store the product in the stated permissible ambient conditions in terms of temperature and air humidity.  
Protect the product against dust and dirt.

##### *Disposal*

The product is made up of various materials that can be reused or are suitable for separation and recycling.  
Dispose of the product in accordance with local regulations.



## 15.6. Terminology and Abbreviations

### *Encoder*

Mounted on the motor, the angular position sensor provides frequency pulses proportional to the motor speed.

### *Degree of protection*

The degree of protection is a standard definition used for electrical equipment that aims to describe the protection against penetration of solids and liquids inside the motor casing (for example IP54M). The M indicates that the tests are conducted with the motor running.

This value cannot take account of the seal around the output shaft, for which the installer must take responsibility.

### *Axial forces*

Longitudinal traction or compression forces affecting the shaft.

### *Radial forces*

Radial forces affecting the shaft.

### *Direction of rotation*

Positive or negative direction of rotation of the motor shaft. The positive direction of rotation is clockwise rotation of the motor shaft, when looking at the motor from the output shaft.

### *Nominal speed*

Motor speed of rotation when nominal torque is applied.

### *Nominal current*

Current drawn by the motor when nominal torque is applied.

### *Nominal torque*

Maximum applicable torque in continuous duty on the motor shaft.

### *Firmware*

Control software embedded in the motor.

### *Bootloader*

Function available in the HMI which can be used to update the firmware.

Commonly used abbreviations:

HMI:	Human-Machine Interface
SMi21:	Trade name of the new CROUZET brushless range
Homing:	Initialization phase for finding the limits
AON:	Type of digital inputs/outputs (All Or Nothing)
PWM:	Pulse Width Modulation
FWD:	Forward
REV:	Reverse
NO:	Normally Open
NC:	Normally Closed
EMC:	Electromagnetic Compatibility