

NOTES

- MATERIAL:
  - CAGE: NICKEL SILVER, THICKNESS: 0.25mm
  - CONNECTOR HOUSING: GLASS FILLED HIGH TEMP PLASTIC, 94 V-0 COLOR BLACK
  - OVERMOLDED TERMINALS HOUSING: GLASS FILLED HIGH TEMP PLASTIC, 94 V-0, COLOR: BLACK
  - TERMINALS: TIN BRASS
  - LIGHT PIPES: POLYCARBONITE, 94 V-0, COLOR: CLEAR
  - LIGHT PIPE HOUSING: ZINC
- FINISH:
  - LIGHT PIPE HOUSING: 150 MICROMETERS NICKEL OVER 150 MICROMETERS COPPER
  - TERMINAL: CONTACT AREA: 0.76 MICROMETERS MINIMUM, HARD GOLD OVER 1.27 MICROMETERS MINIMUM NICKEL.
  - COMPLIANT TAIL - TIN/LEAD OPTION: 0.76 - 1.52 MICROMETERS 90/10 TIN/LEAD OVER 0.76 - 1.52 MICROMETERS NICKEL
  - COMPLIANT TAIL - TIN OPTION: 0.76 - 1.52 MICROMETERS TIN OVER 0.76 - 1.52 MICROMETERS NICKEL
- REFER TO PS-75310-001 PRODCET SPEC FOR ALL ELECTRICAL, MECHANICAL, AND ENVIRONMENTAL SPECIFICATIONS.
- LIGHT PIPE PAD LAYOUT IS FOR 0805 LOW-PORFILE LED PACKAGE. FOR OTHER RECOMMENDED LAYOUTS REFER TO MOLEX'S REPORT TS-75310-001.
- REFER TO PK-75714-001 FOR ALL PACKAGING SPECIFICATIONS.
- THE CURVED TAILS THAT GO INTO THE HOLES LOCATED BY THESE DIMENSIONS ARE BEING ELIMINATED. TO ACCOMMODATE THIS CONVERSION, IT IS RECOMMENDED THAT BOARDS DESIGNED TO THIS PRINT REVISION INCLUDE THESE HOLES.
- PART COMPLIES WITH COSMETIC SPECIFICATION PS-45499-002. SEE SHEET 4 SECTION A-A FOR SURFACE CLASSIFICATIONS. UNDERSIDE OF CAGE COMPLIES WITH CLASS "C".

PART NUMBER	DESCRIPTION	VIEW	COMPLIANT TAIL PLATING
75714-0001	4 PORT LIGHT PIPE	SEE PG 2	TIN LEAD
75714-0002	INNER 2 PORTS	SEE PG 2	TIN LEAD
75714-0003	OUTER 2 PORTS	SEE PG 2	TIN LEAD
75714-5001	4 PORT LIGHT PIPE	SEE PG 2	TIN
75714-5002	INNER 2 PORTS	SEE PG 2	TIN
75714-5003	OUTER 2 PORTS	SEE PG 2	TIN

ADD KEEP OUT ZONES EC NO: UCP2010-0369 DRWINMS BARRA 6/5/09 CHKD:BBARKER 2009/08/26 APPR:SMILLER 2009/08/27	QUALITY SYMBOLS ▽=0 ▽=0	GENERAL TOLERANCES (UNLESS SPECIFIED)		DIMENSION STYLE MM ONLY		SCALE 3:1	DESIGN UNITS METRIC	THIRD ANGLE PROJECTION	
		4 PLACES ± --- ± --- 3 PLACES ± --- ± --- 2 PLACES ± 0.13 ± --- 1 PLACE ± 0.25 ± ---	mm INCH ± --- ± --- ± 0.13 ± --- ± 0.25 ± ---	DRAWN BY HAVERY	DATE 10-15-2004	TITLE STACKED SFP 2X2 MEDIUM HEIGHT ASS'Y, PRESS-FIT TAILS WITH LIGHT PIPES			
		ANGULAR ± 5 °		CHECKED BY JLONG	DATE 11-27-2004	MOLEX INCORPORATED			
		DRAFT WHERE APPLICABLE MUST REMAIN WITHIN DIMENSIONS		APPROVED BY RNELSON	DATE 11-29-2004	MATERIAL NO. SEE TABLE	DOCUMENT NO. SD-75714-001	SHEET NO. 1 OF 4	

THIS DRAWING CONTAINS INFORMATION THAT IS PROPRIETARY TO MOLEX INCORPORATED AND SHOULD NOT BE USED WITHOUT WRITTEN PERMISSION

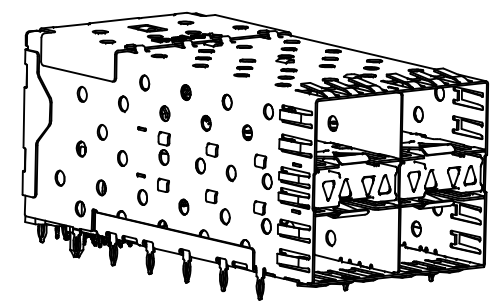
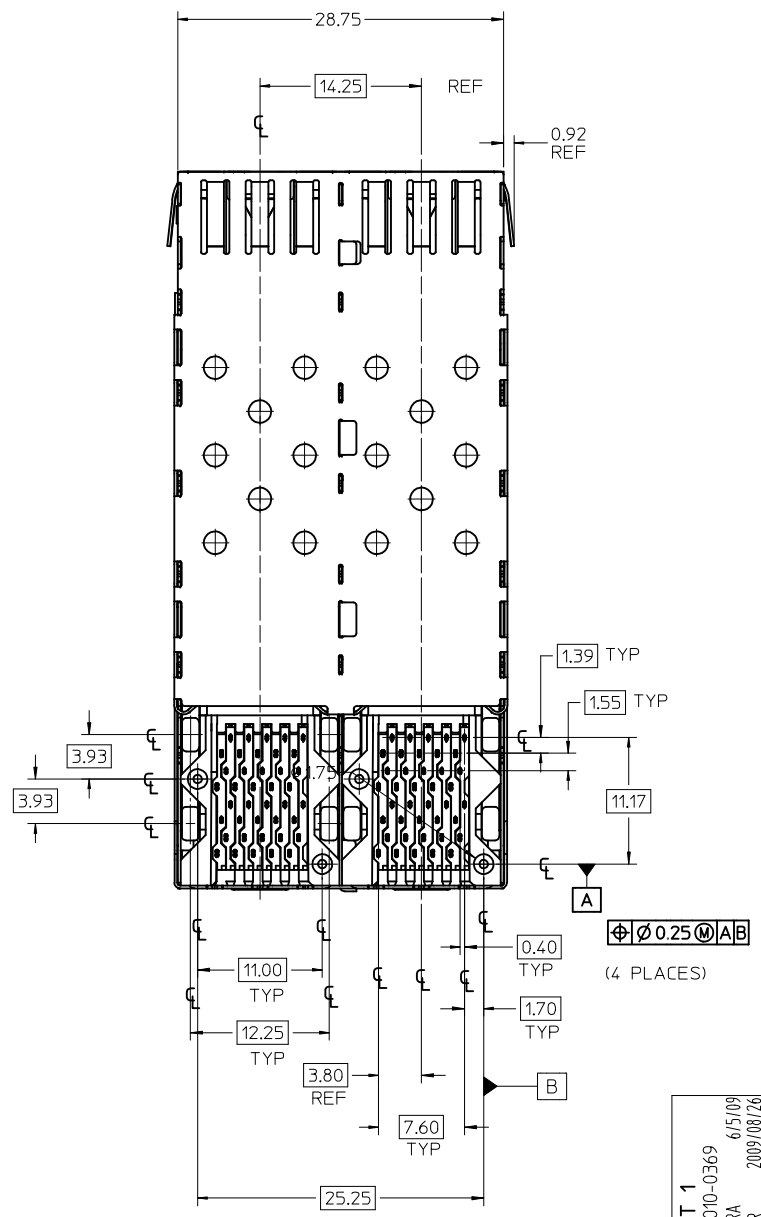

75714-0001 & 75714-5001  
WITH INNER/OUTER LIGHT PIPES

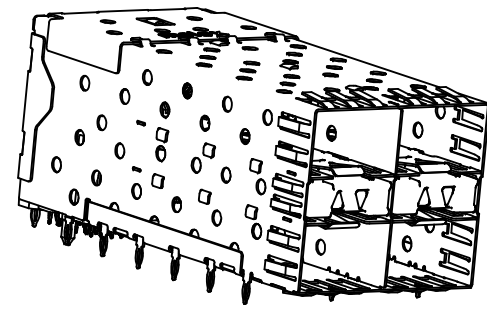

75714-0002 & 75714-5002  
WITH INNER LIGHT PIPES

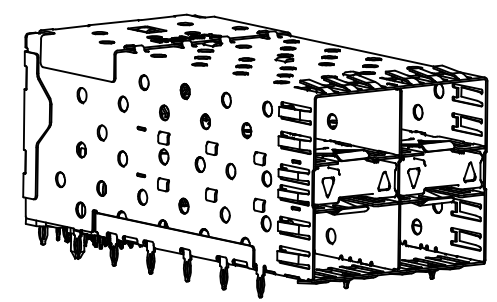

75714-0003 & 75714-5003  
WITH OUTER LIGHT PIPES

SEE SHEET 1 EC NO: UCP2010-0369 DRWN:MSIBARRA 6/5/09 CHKD:BBARKER 2009/08/26 APPR:SMILLER 2009/08/27	QUALITY SYMBOLS ▽=0 ▽=0	GENERAL TOLERANCES (UNLESS SPECIFIED) <table border="1"> <thead> <tr> <th></th> <th>mm</th> <th>INCH</th> </tr> </thead> <tbody> <tr> <td>4 PLACES</td> <td>± 0.13</td> <td>± 0.005</td> </tr> <tr> <td>3 PLACES</td> <td>± 0.13</td> <td>± 0.005</td> </tr> <tr> <td>2 PLACES</td> <td>± 0.13</td> <td>± 0.005</td> </tr> <tr> <td>1 PLACE</td> <td>± 0.25</td> <td>± 0.010</td> </tr> </tbody> </table>		mm	INCH	4 PLACES	± 0.13	± 0.005	3 PLACES	± 0.13	± 0.005	2 PLACES	± 0.13	± 0.005	1 PLACE	± 0.25	± 0.010	DIMENSION STYLE MM ONLY	SCALE 3:1	DESIGN UNITS METRIC	THIRD ANGLE PROJECTION
		mm	INCH																		
	4 PLACES	± 0.13	± 0.005																		
	3 PLACES	± 0.13	± 0.005																		
2 PLACES	± 0.13	± 0.005																			
1 PLACE	± 0.25	± 0.010																			
DRAWN BY HAVERY	DATE 10-15-2004	CHECKED BY JLONG	DATE 11-27-2004	STACKED SFP 2X2 MEDIUM HEIGHT ASS'Y, PRESS-FIT TAILS WITH LIGHT PIPES																	
APPROVED BY RNELSON	DATE 11-29-2004	MOLEX INCORPORATED			SHEET NO. 2 OF 4																
DRAFT WHERE APPLICABLE MUST REMAIN WITHIN DIMENSIONS	SEE TABLE	MATERIAL NO. SD-75714-001	DOCUMENT NO.	THIS DRAWING CONTAINS INFORMATION THAT IS PROPRIETARY TO MOLEX INCORPORATED AND SHOULD NOT BE USED WITHOUT WRITTEN PERMISSION																	

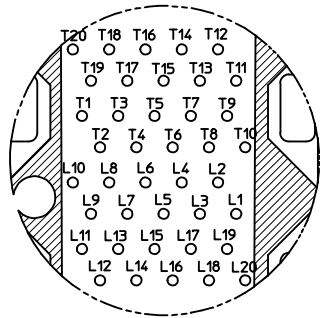

CONNECTOR PIN-OUT  
COMPONENT SIDE OF BOARD

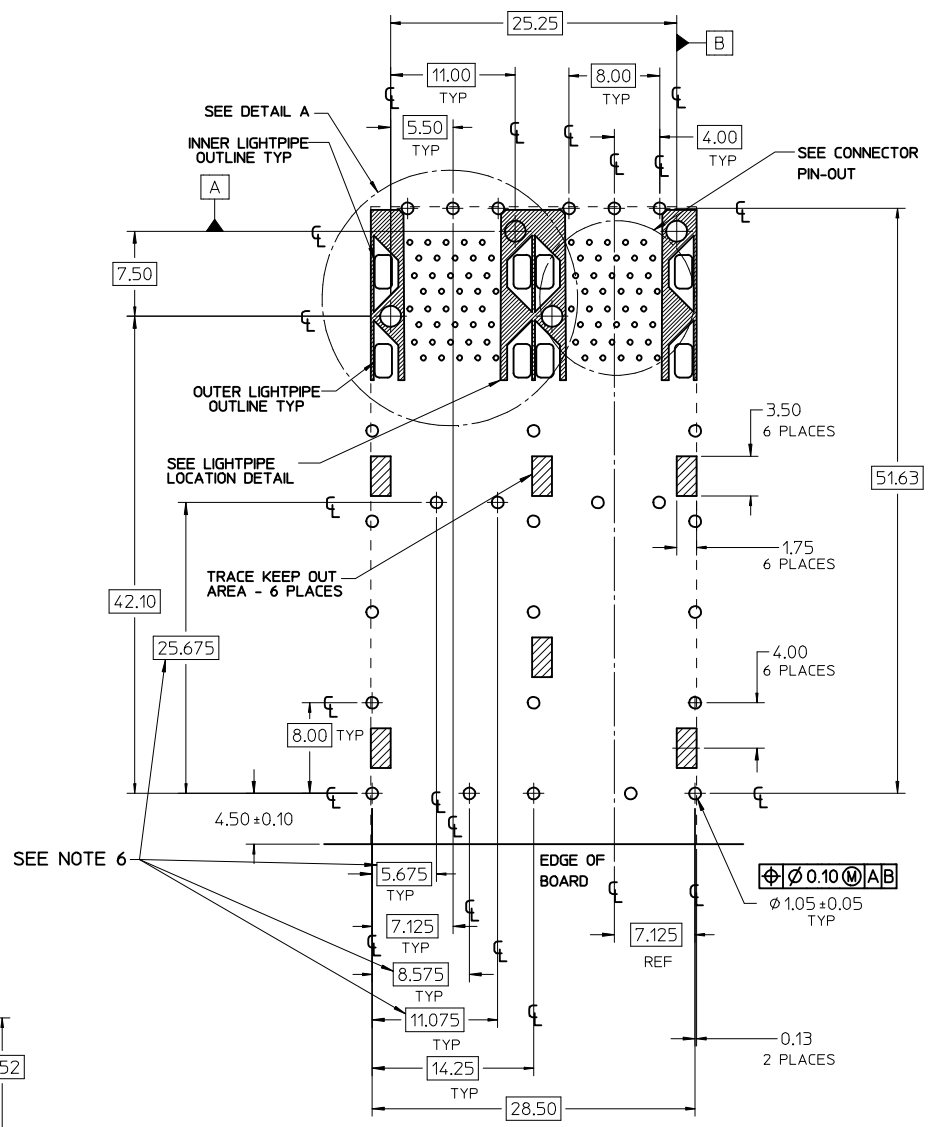
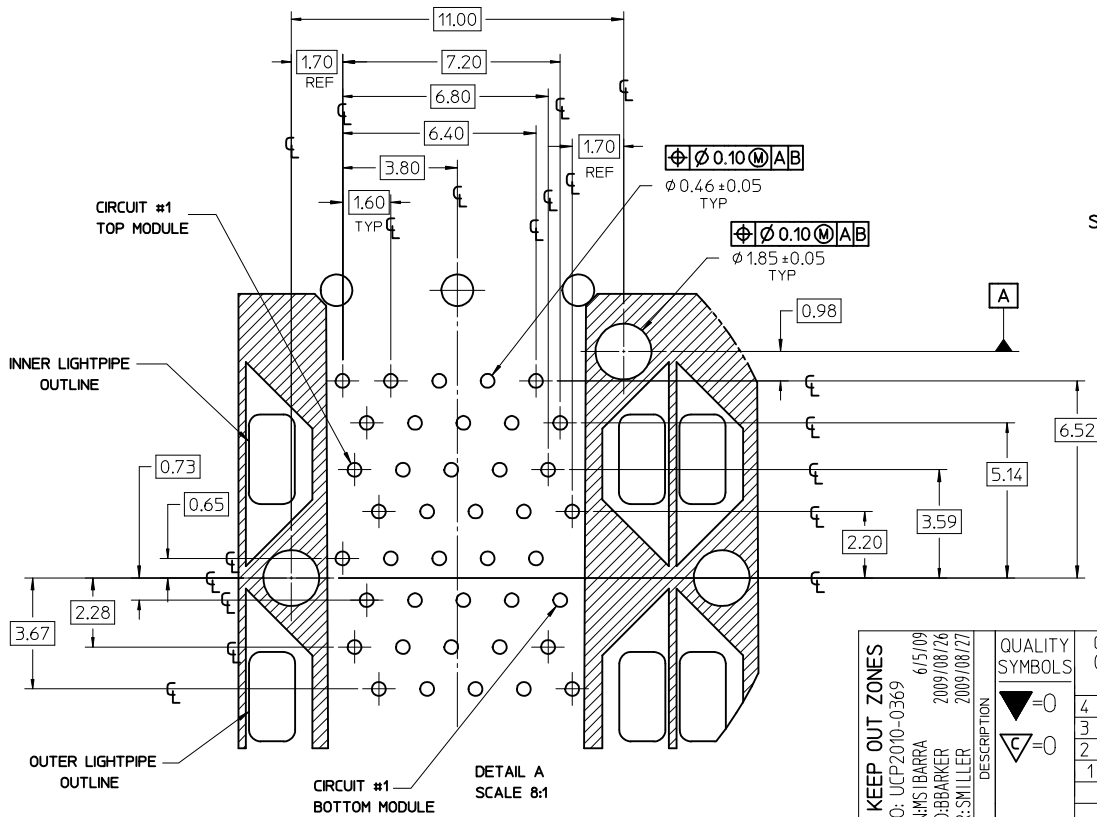

RECOMMENDED PCB LAYOUT - COMPONENT SIDE  
RECOMMENDED PCB THICKNESS - 2.36 MM (0.093 INCH)  
THE ENTIRE AREA OF THE CONNECTOR FOOTPRINT  
TO BE CONSIDERED THE KEEP OUT AREA FOR COMPONENTS  
(OTHER THAN LIGHT PIPE LED'S)  
THIS AREA IS INDICATED BY THE DASHED LINE

<b>ADD KEEP OUT ZONES</b> EC NO: UCP2010-0369 DRWN:MSI BARRA 6/5/09 CHKD:BBARKER 2009/08/26 APPR:SWILLER 2009/08/27	QUALITY SYMBOLS ▽=0 ▽=0	GENERAL TOLERANCES (UNLESS SPECIFIED)		DIMENSION STYLE <b>MM ONLY</b>	SCALE <b>3:1</b>	DESIGN UNITS <b>METRIC</b>	THIRD ANGLE PROJECTION
		4 PLACES ± --- ± --- 3 PLACES ± --- ± --- 2 PLACES ± 0.13 ± --- 1 PLACE ± 0.25 ± --- ANGULAR ± 5 °	mm INCH	DRAWN BY DATE HAVERY 10-15-2004 CHECKED BY DATE JLONG 11-27-2004 APPROVED BY DATE RNELSON 11-29-2004	TITLE <b>STACKED SFP 2X2 MEDIUM HEIGHT ASS'Y, PRESS-FIT TAILS WITH LIGHT PIPES</b>	MOLEX MOLEX INCORPORATED	SHEET NO. <b>3 OF 4</b>
DRAFT WHERE APPLICABLE MUST REMAIN WITHIN DIMENSIONS	SEE TABLE	MATERIAL NO.	DOCUMENT NO.	<b>SD-75714-001</b>	THIS DRAWING CONTAINS INFORMATION THAT IS PROPRIETARY TO MOLEX INCORPORATED AND SHOULD NOT BE USED WITHOUT WRITTEN PERMISSION		

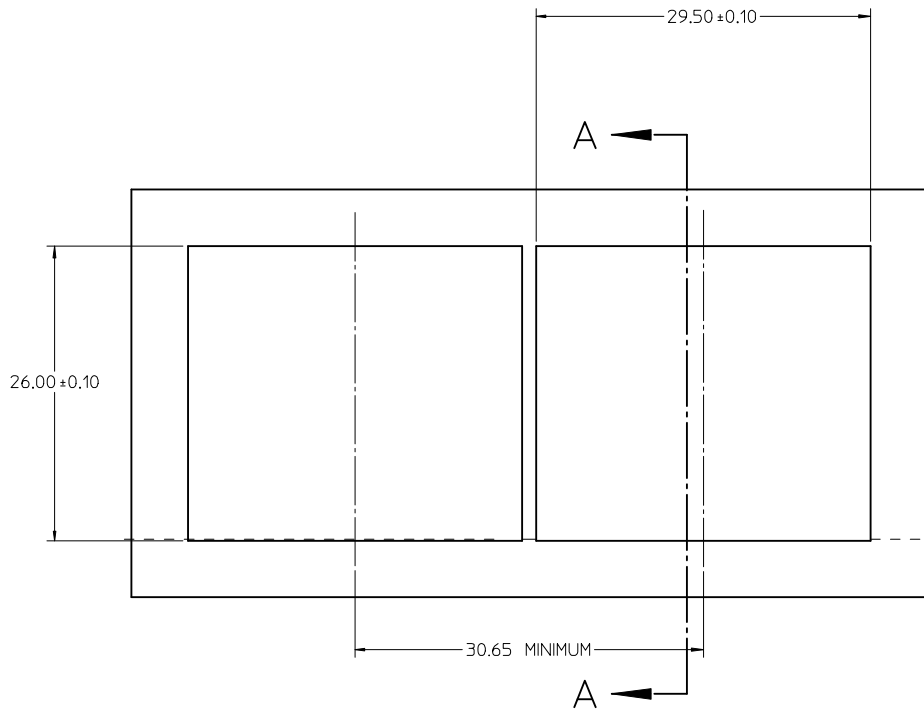

BEZEL CUT-OUT CENTER SPACING DETAIL  
BEZEL THICKNESS: 0.8 - 2.6

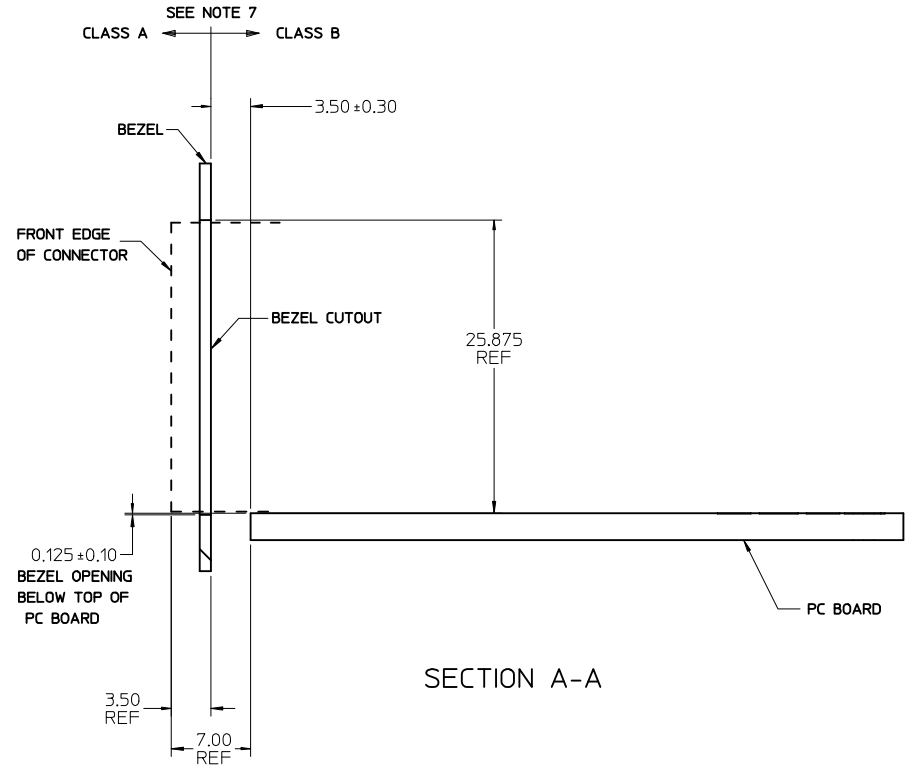

SECTION A-A

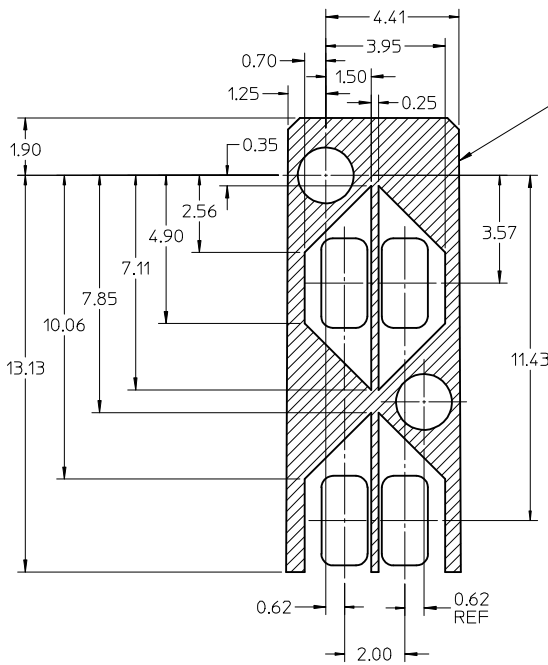

THE HATCHED AREA IN THIS VIEW INDICATES ZONES THAT ARE OCCUPIED BY THE PLASTIC HOUSING THAT SEATS AGAINST THE PCB AND BY THE VERTICAL METAL CAGE WALL THAT STOPS JUST SHORT OF THE PCB

DETAIL - LIGHT PIPE LOCATION AND OTHER ZONES  
SCALE 8:1

<b>SEE SHEET 1</b> EC NO: UCP2010-0369 6/5/09 DRW:MSI BARRA CHK:DBARKER APPR:SMILLER 2009/08/26 2009/08/27	QUALITY SYMBOLS ▽=0 ▽=0	GENERAL TOLERANCES (UNLESS SPECIFIED)		DIMENSION STYLE <b>MM ONLY</b>	SCALE <b>3:1</b>	DESIGN UNITS <b>METRIC</b>	THIRD ANGLE PROJECTION
		4 PLACES ± --- ± --- 3 PLACES ± --- ± --- 2 PLACES ± 0.13 ± --- 1 PLACE ± 0.25 ± --- ANGULAR ± 5°	mm INCH ± --- ± --- ± --- ± --- ± --- ± --- ± --- ± ---	DRAWN BY HAVERY	DATE 10-15-2004	TITLE <b>STACKED SFP 2X2 MEDIUM HEIGHT ASS'Y, PRESS-FIT TAILS WITH LIGHT PIPES</b>	<b>MOLEX INCORPORATED</b>
APPROVED BY RNELSON	DATE 11-29-2004	DRAFT WHERE APPLICABLE MUST REMAIN WITHIN DIMENSIONS		SEE TABLE	DOCUMENT NO. <b>SD-75714-001</b>	SHEET NO. <b>4 OF 4</b>	