

This document is the property of Amphenol Corporation and is delivered on the express condition that it is not to be disclosed, reproduced or used, in whole or in part, for manufacture or sale by anyone other than Amphenol Corporation without the prior consent. It is not to be used to disclose or to use any information in this document.

REVISIONS				
SYM	ECN	DESCRIPTION	DATE	APPROVED
		SEE SHEET 1		

ORDERING INFORMATION

E 842 - 816 - XX XX - X XX X

Date code _____
 Nil - No date code
 E - Date code printed Δ

No. of contact _____

Body & pin configuration _____
 (Refer to Table III)

Lock & Eject (L&E) and mounting stud options _____
 0 - no L&E, no stud
 1 - short L&E, no stud
 2 - short L&E, short stud
 3 - short L&E, long stud
 4 - long L&E, no stud
 5 - long L&E, short stud
 6 - long L&E, long stud
 F - long L&E, M2.5 stud

Nil - standard
 S - standard with polarizing key slot for size 10 Δ

Plating
 AA - gold flash duplex
 19 - 15u" gold plated duplex
 35 - 30u" gold plated duplex

Notes:

- Connectors purchased under this drawing will mate with MIL-C-83503/7B socket connector with strain relief or without strain relief and Amphenol's 812 connector.
- This assembly is designed to meet requirements of MIL-C-83503.
- Δ The polarizing key slot on this end does not exist on size 10 and 14.
- Δ Prefix "E" only applies to the four-sided version & polarizing key slot is available for all size including size 10.
- Δ Suffix "S" only applies to the size 10 since the polarizing key slot is absent from the standard size 10.
- This connector is both UL and CSA approved.
- Refer to Amphenol S-816-001 for product specification.
- MATERIAL SHOULD BE FULFILLED AMPHENOL SPEC#SSN001.

Table III

Standard product - four side grey	Non-standard product - three side grey (specific quantity required)	K
30 - straight solder tail, for 0.062" [1.6 mm] PCB	20 - obsolete	0.109 ± 0.007 [2.61 ± 0.34] coined tail
31 - straight solder tail, for 0.125" [3.2 mm] PCB	21 - obsolete	0.171 ± 0.008 [4.14 ± 0.36] coined tail
32 - right angle solder tail, for 0.062" [1.6 mm] PCB	22 - obsolete	0.109 ± 0.007 [2.61 ± 0.34] coined tail
33 - right angle solder tail, for 0.125" [3.2 mm] PCB	23 - obsolete	0.171 ± 0.008 [4.14 ± 0.36] coined tail
37 - straight wire wrap tail	27 - obsolete	0.61 ± 0.015 [15.49 ± 0.38] square tail
39 - right angle wire wrap tail	29 - obsolete	0.61 ± 0.015 [15.49 ± 0.38] square tail

Table IV

Size	A	B	C	D	E	F
10	1.26 [32.07]	1.10 [27.94]	0.860 [21.84]	0.708 [17.98]	0.400 [10.16]	4
14	1.46 [37.08]	1.30 [33.02]	1.060 [26.92]	0.908 [23.06]	0.600 [15.24]	6
16	1.56 [39.62]	1.40 [35.56]	1.160 [29.46]	1.008 [25.60]	0.700 [17.78]	7
20	1.76 [44.70]	1.60 [40.64]	1.360 [34.54]	1.208 [30.68]	0.900 [22.86]	9
26	2.06 [52.32]	1.90 [48.26]	1.660 [42.16]	1.508 [38.30]	1.200 [30.40]	12
30	2.26 [57.40]	2.10 [53.34]	1.860 [47.24]	1.708 [43.38]	1.400 [35.56]	14
34	2.46 [62.48]	2.30 [58.42]	2.060 [52.32]	1.908 [48.46]	1.600 [40.64]	16
40	2.76 [70.10]	2.60 [66.04]	2.360 [59.94]	2.208 [56.08]	1.900 [48.26]	19
50	3.26 [82.80]	3.10 [78.74]	2.860 [72.64]	2.708 [68.78]	2.400 [60.96]	24
60	3.76 [95.50]	3.60 [91.44]	3.360 [85.34]	3.208 [81.48]	2.900 [73.66]	29
64	3.96 [100.58]	3.80 [96.52]	3.560 [90.42]	3.408 [86.60]	3.100 [78.74]	31

Recommended PCB layout

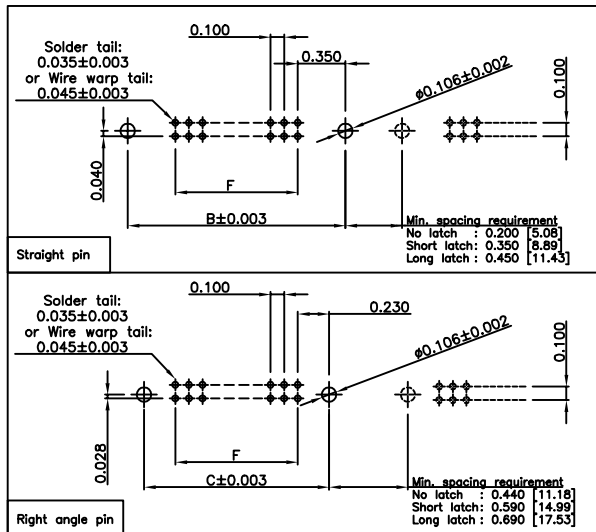

Customer Drawing

UNLESS OTHERWISE SPECIFIED TOLERANCES		APPROVAL		DATE		Amphenol	
	U.S.			DRAWN ALEXLEE	07/18/05		
.X	+/- .020			CHECKED TSUI	07/18/05		
.XX	+/- .010			CHECKED			
.XXX	+/- .005						
FRACTIONS	+/-					TITLE	
ANGLES	+/- 2.5° 2.5°					816 Protected Header	
FOR MATERIALS AND FINISHES SEE NOTES		DRAWING FILE : DRAWING_816_CB16.DWG		ANGLE OF PROJECTION		SIZE DRAWING NO.	
REMOVE SHARP EDGES				DIMENSIONS		A3 C816-XXXX-XXX	
U.S. INCHES				METRIC MM		REV. T	
				SCALE NONE		SHEET 2 OF 2	

This document is the property of Amphenol Corporation and is delivered on the express condition that it is not to be disclosed, reproduced or used, in whole or in part, for manufacture or sale by anyone other than Amphenol Corporation without the prior consent, & that no right is granted to disclose or to use any information in this document.

REVISIONS

SYM	ECN	DESCRIPTION	DATE	APPROVED
Q	HK1421	RELEASE TO CUSTOMER	06/12/97	NELSON
R	HK1513	***TAIL SIZE MODIFIED	06/01/98	Michael Tsai
S	HK2043	Revise L&E options&delete three side option	8/24/01	Michael IP
T	HK3437	UPDATE DRAWING TO COMPLY WITH RoHS	07/18/05	Michael IP

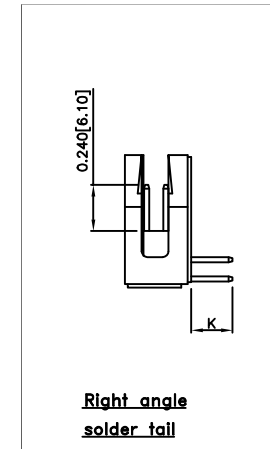
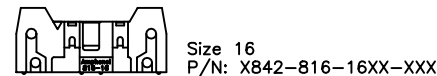
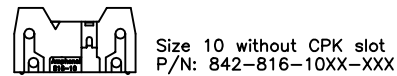
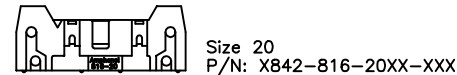
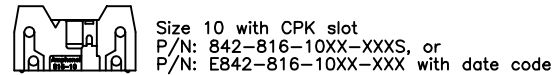
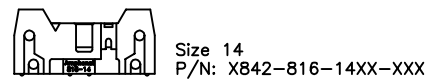
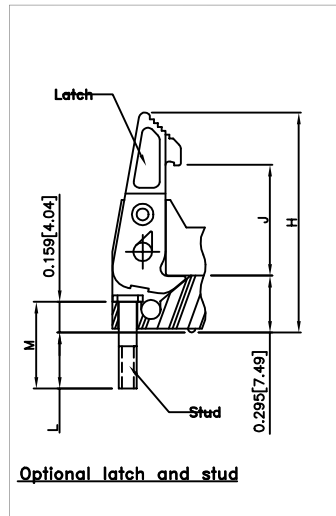
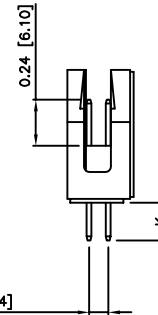
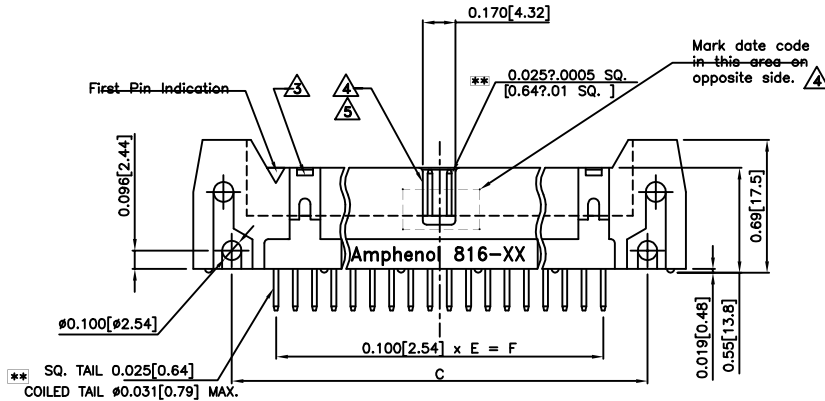
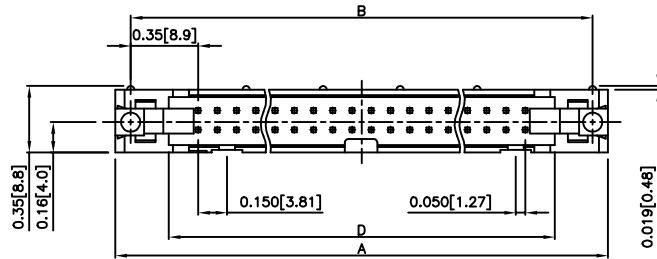

Customer Drawing

Table I

Latch & Eject	J	H
Short: for use with non strain relief socket	0.425 [10.80]	1.015 [25.78]
Long for use with strain relief socket	0.575 [14.61]	1.135 [28.83]

Table II

Stud	L	M
Short stud 2-56	0.29 [7.4]	0.45 [11.43]
Long stud 2-56	0.36 [9.1]	0.52 [13.21]
Stud M2.5	0.18 [4.6]	0.34 [8.6]

Note: unit in inch [mm]

UNLESS OTHERWISE SPECIFIED TOLERANCES

	U.S.	METRIC
.X +/-	.020	0.51
.XX +/-	.010	0.25
.XXX +/-	.005	0.13
FRACTIONS +/-		
ANGLES +/-	2.5°	2.5°

FOR MATERIALS AND FINISHES SEE NOTES

REMOVE SHARP EDGES

DIMENSIONS	
U.S.	INCHES
METRIC	MM

APPROVAL	DATE
DRAWN ALEX.LEE	07/18/05
CHECKED TSUN	07/18/05
CHECKED	

DRAWING FILE: \DRAWING_816\C816.DWG

ANGLE OF PROJECTION

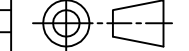

TITLE		REV.
Amphenol		
816 Protected Header		
SIZE	DRAWING NO.	REV.
A3	C816-XXXX-XXX	T
SCALE	NONE	SHEET 1 OF 2